

Rover K FT

NC processing centre

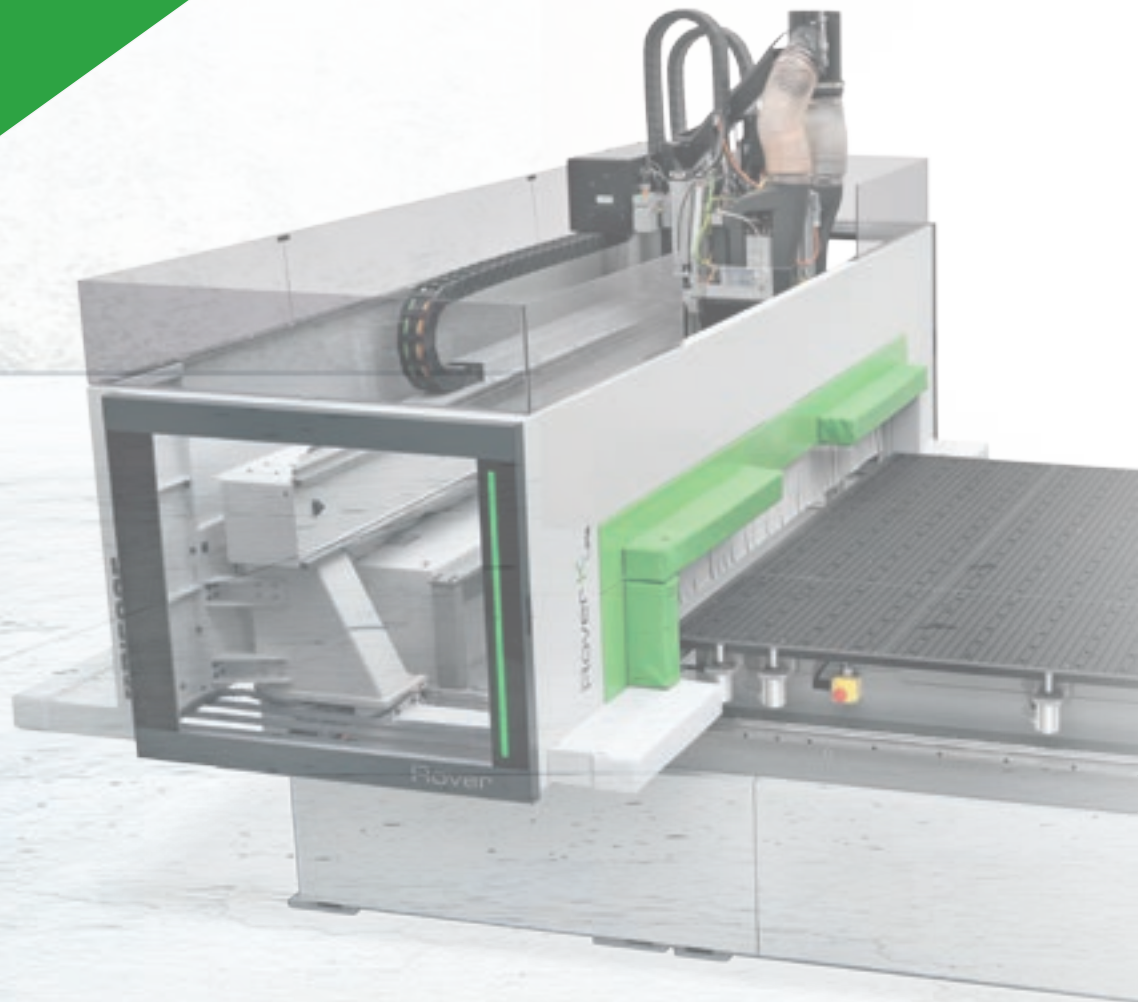

When competitiveness
means maximum
performance,
minimum
investment



Made **In** Biesse

The market demands

a change in manufacturing processes, enabling companies to **accept the largest possible number of orders**. This is coupled with the need to maintain high quality standards whilst offering product customisation **with quick and reliable delivery times**.

Biesse responds

with simple, innovative solutions for nesting operations. **Rover K FT** is the new Biesse numerical control machining centre with Gantry structure - the most compact on the market - designed to machine panels made from wood and its derivatives. The ideal solution for artisan producers and for small and medium-sized businesses which require flexibility and ease of use within a limited production space.

- ▶ **Compact and ergonomic.**
- ▶ **Fast installation and start-up.**
- ▶ **Ease of use.**
- ▶ **Maximum "custom" flexibility.**
- ▶ **Advanced technology for exceptional finish quality.**
- ▶ **Maximum operator safety.**
- ▶ **Fully integrated into production flows.**

Extremely compact and
high-performance

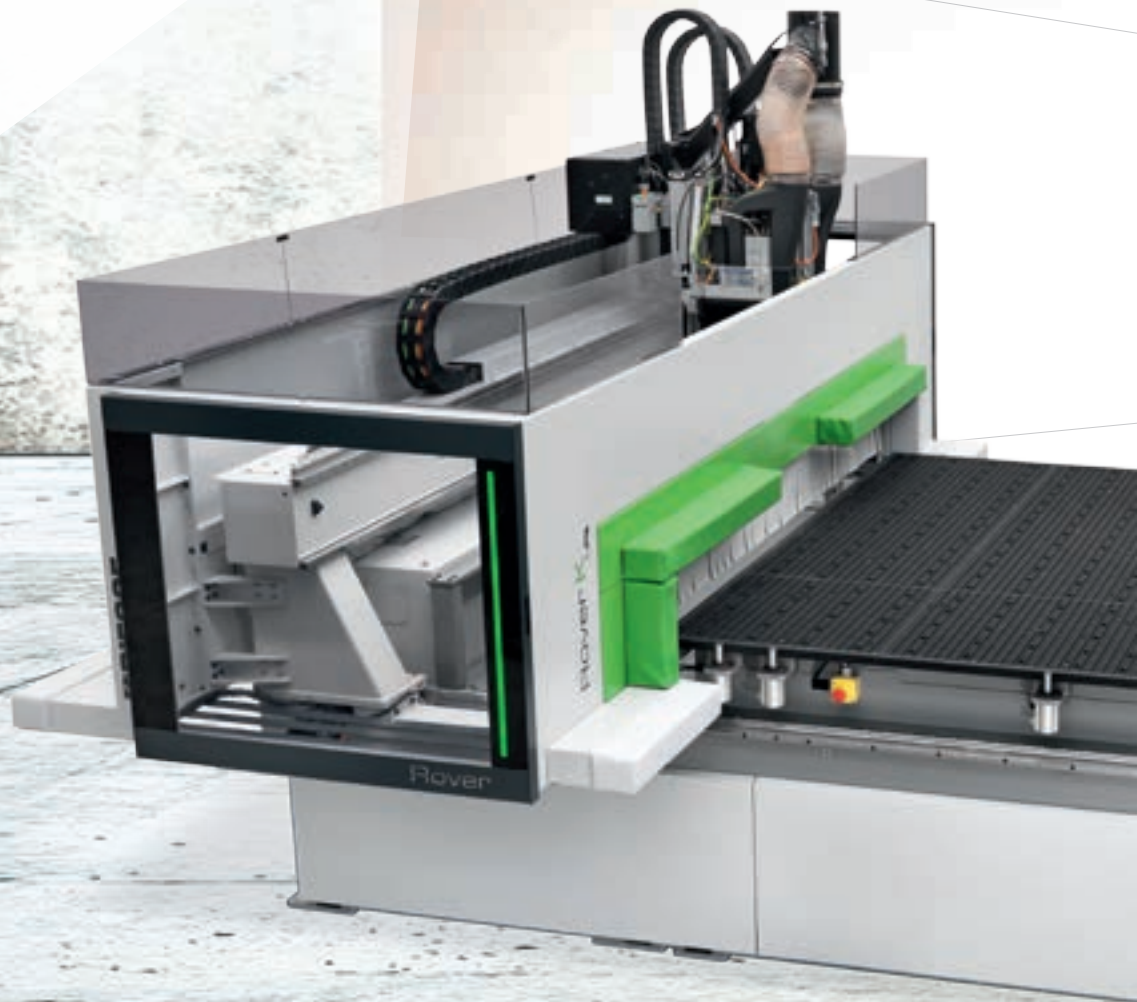

Rover **KFT**
NC processing centre



A single work centre for many types of machining operations

Rover K FT can carry out various types of machining operation, including: the nesting of small doors and furniture elements, scoring on solid wood, panels and doors.



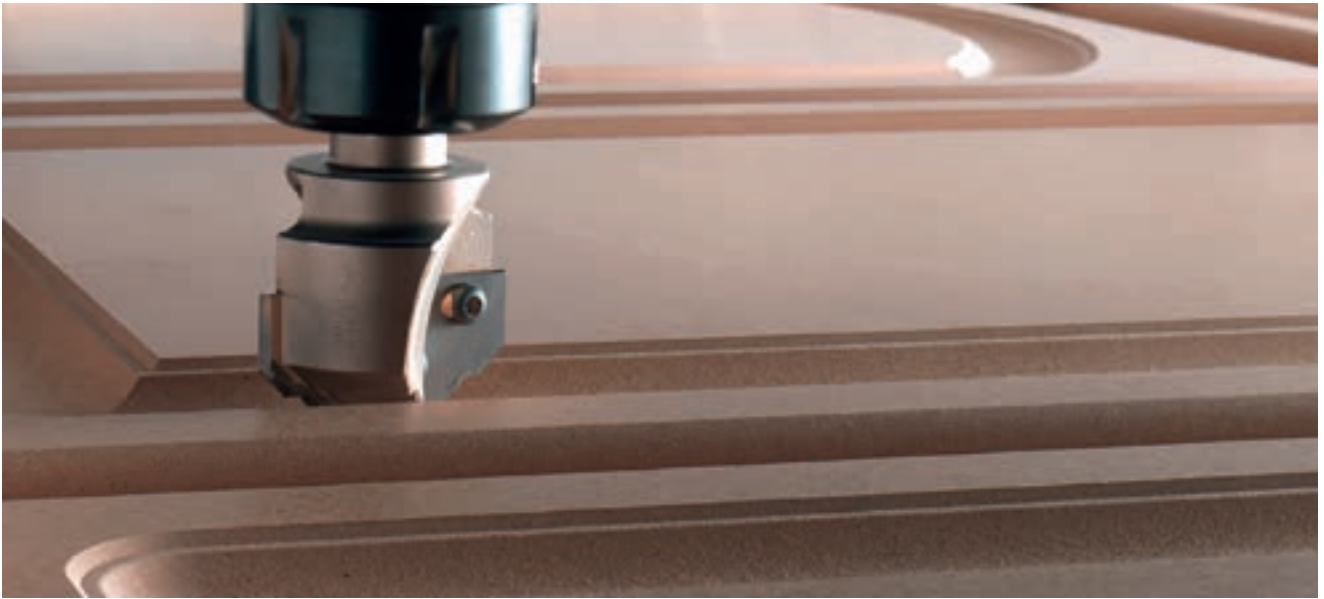

Compact and ergonomic

An extremely compact machine designed to adapt to the production space in which it is installed. Enables the operator to safely access all sides of the machine at all times, with no obstacles on the ground.



Can be installed in just one day

The new Rover K FT is designed to offer maximum performance in an extremely compact solution with the minimum working dimensions. Rover K FT represents the first of Biesse's new quick-installation **plug&play** solutions.

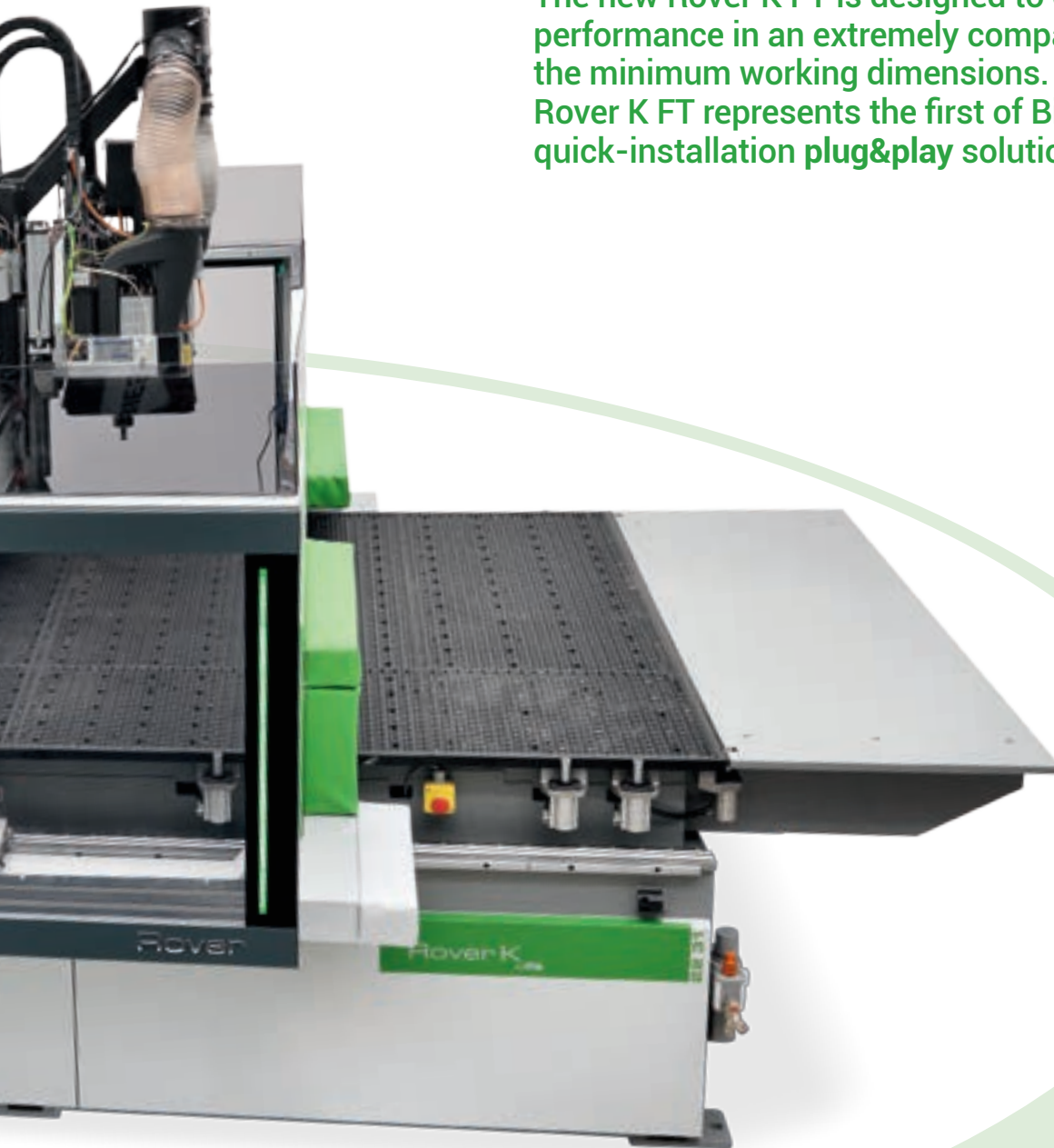

Maximum "custom" flexibility

The wide range of sizes available enables panels of all dimensions typical of nesting processes to be machined, enabling customers to choose the machine that best meets their needs.



- Rover K FT 1224
- Rover K FT 1236
- Rover K FT 1531
- Rover K FT 1536
- Rover K FT 1836
- Rover K FT 2231
- Rover K FT 2243



Advanced work table technology to machine panels of different types and sizes with the utmost reliability.

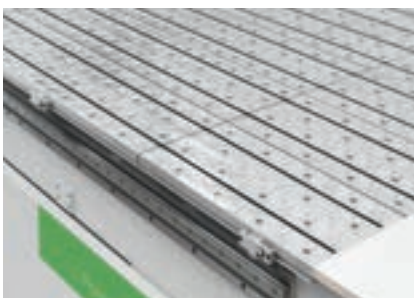

The aluminium work table allows pieces to be mechanically locked via the T-slots or the vacuum system (optional), reducing the machine set-up times.



Work table in layered phenolic material with vacuum system.

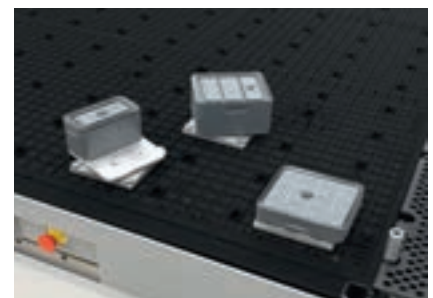

Vacuum modules can be freely positioned on the FT work table with no need for special connections.

Maximum panel security thanks to an advanced distributed vacuum system within the work table.

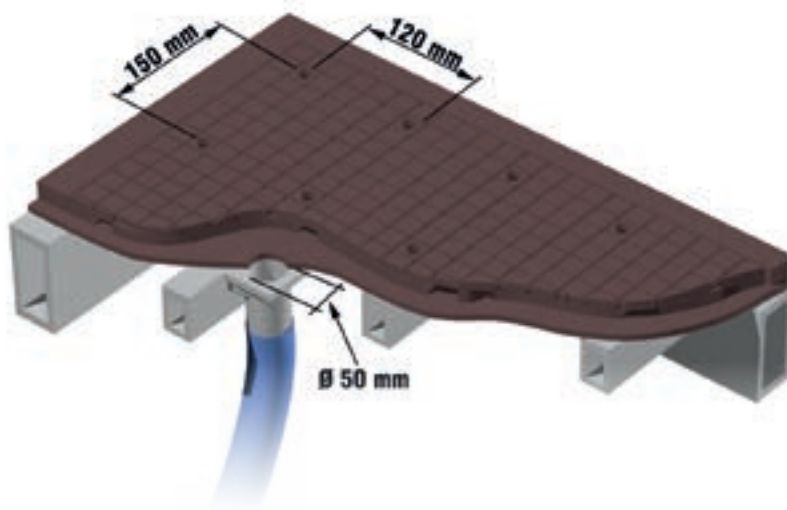

Multi-zone technology seamlessly and automatically adapts the vacuum of the machine to the different board sizes that the customer has in his production.



The locking of the vacuum adapts perfectly to the panel size and enables the switching from one format to another without the need for manual operations.



Practical design

The transparent polycarbonate reinforced protection door is designed to guarantee maximum visibility for the operator. Fitted with 5-colour LEDs indicating machine status, it ensures that processing phases can be easily and safely monitored.

BIESSE IDENTITY

An innovative yet simple design is the hallmark of Biesse's distinctive identity. The perfect combination of Italian genius and taste.

ROVER

Advanced technology for exceptional finish quality

The components of Rover K FT configurations are the same as those used across Biesse's high-end solutions. The electrospindle, boring head and aggregates are designed and manufactured for Biesse by HSD, the global leader in this sector.



Electrospindles for every application:
- 5 kW HSD with manual tool change 1,000-24,000 rpm
- 9 kW HSD with automatic tool change ISO30 / HSK F63 1,000- 24,000 rpm.

C Axis Torque: quicker, more precise, more rigid.

Large magazine capacity for performing all types of machining operation



Thanks to the 14 position tool-holder rack, tools and aggregates are always available, without the need for operator intervention when moving from one machining process to the next.

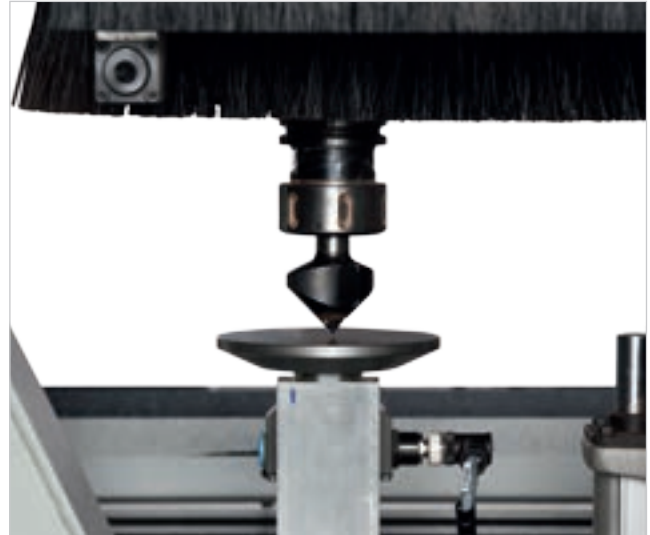

Reduction of tool change set-up time and the possibility of operator error, thanks to the contact pre-setter, which automatically determines the length of the tool.

A complete range of aggregates



High reliability and precision over time

Rover K FT has a robust and well-balanced structure, designed to handle demanding machining requirements without compromising product quality.

The Gantry structure with dual motors is designed to increase standards of precision and reliability when carrying out machining operations.

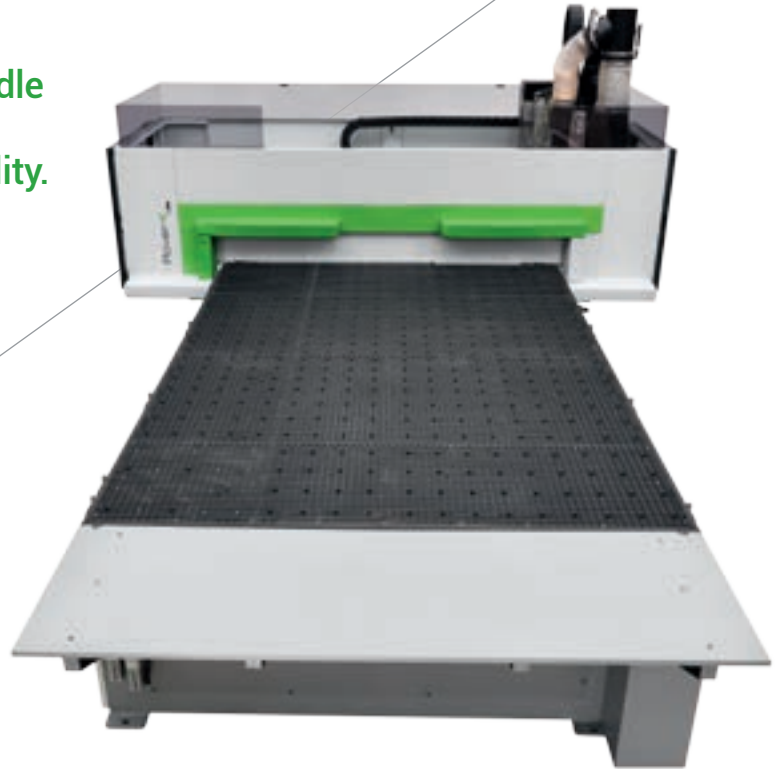

Various optional solutions are available for cleaning the panel and the area around the machine, thus saving time for the operator.



Adjustable suction hood with 6 settings.



Automatic lubrication is an option that ensures the continuous lubrication of the machine's main moving parts without the need for operator intervention.

Fully integrated into production flows

Rover K FT can be easily adapted according to work flow and in line with customer requirements.



Loading/unloading is carried out simultaneously allowing the operator to remove completed components from the unloading station with the utmost safety whilst the machine is already processing the next panel.



Panel identification and traceability with in the production flow thanks to on-demand labelling system with touch screen.

Increasing manufacturing capacity

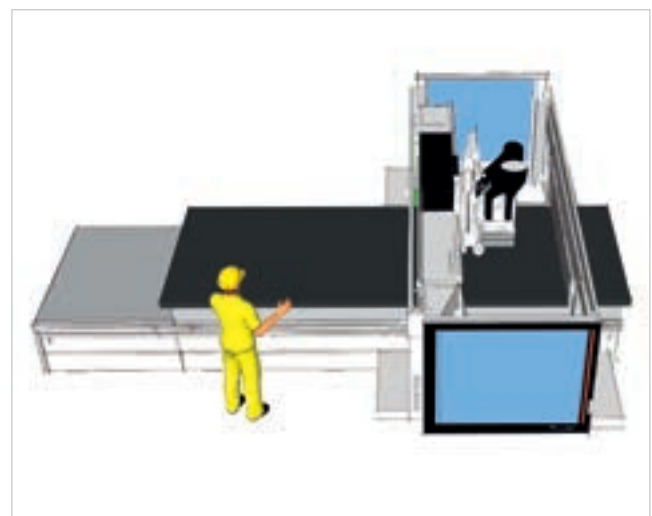

The machine can be configured with tandem loading in order to alternately process panels on opposite origins. This allows loading and unloading to be carried out while the machine is actually running.

Productive economy

Biesse's processing centres for nesting and carving operations allow to achieve a finished produced machined on a single, compact machine at a competitive price. The robust and well-balanced structure of the machine is ideally suited for withstanding greater processing stresses without compromising the quality of the piece and for ensuring the best finish on different types of materials.

NESTING SOLUTIONS

Productivity and efficiency are increased, while maintaining high quality standards and fast delivery times. A perfect combination of Biesse optimisation and Italian genius.



Maximum ergonomics and safety for the operator

Biesse machines are designed to enable operators to work in complete safety.



Total protection of the working unit. The wide hatch provides maximum visibility of the machining operations, as well as ensuring easy access to the working units.

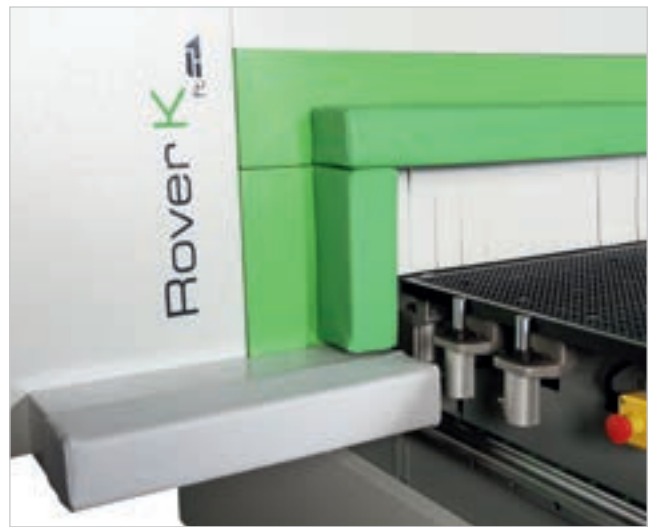

The new full bumper solution enables the operator to safely access the work table at all times from any side of the machine.



Overlapping lateral curtain guards protect the working unit.

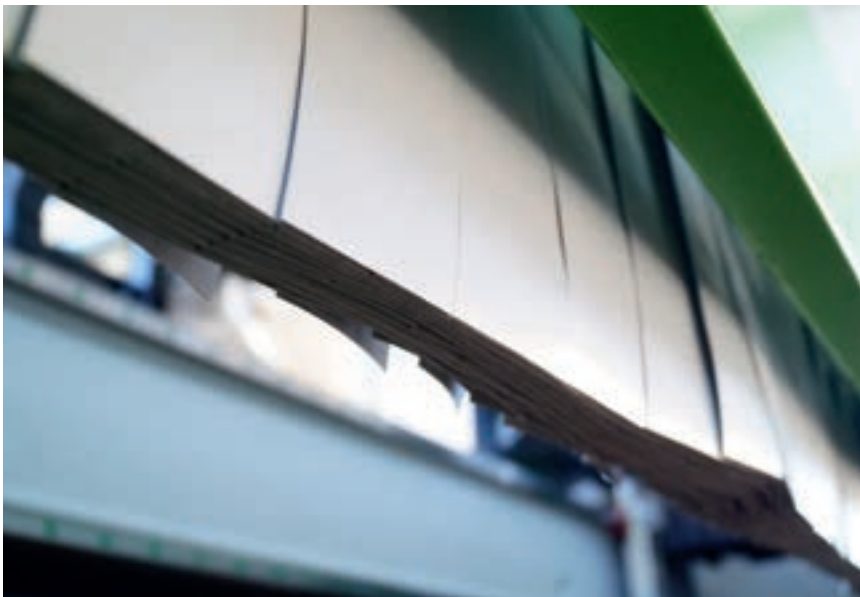



PC with Windows real-time operating system and bSolid software interface, including anti-collision system.

LED bar with 5 colours, indicating the machine status in real time.



High-tech becomes accessible and intuitive



bSolid is a 3D cad cam software program that supports the performance of any machining operation thanks to vertical modules designed for specific manufacturing processes.

- ▶ **Planning in just a few clicks, with endless possibilities.**
- ▶ **Simulating machining operations to visualise the piece ahead of manufacturing and have some guidance for the planning phase.**
- ▶ **Virtual prototyping of the piece to avoid collisions and ensure optimal machine equipment.**

Watch the **bSolid** ad at: youtube.com/biessegroup



bSolid



Reduced time and waste



bNest is the bSuite plugin specifically for nesting operations. It allows you to organise your nesting projects in a simple way, reducing the material waste and machining times.

- ▶ **Reduced production costs.**
- ▶ **Simplified work for the operator.**
- ▶ **Integration with company software.**



bNest

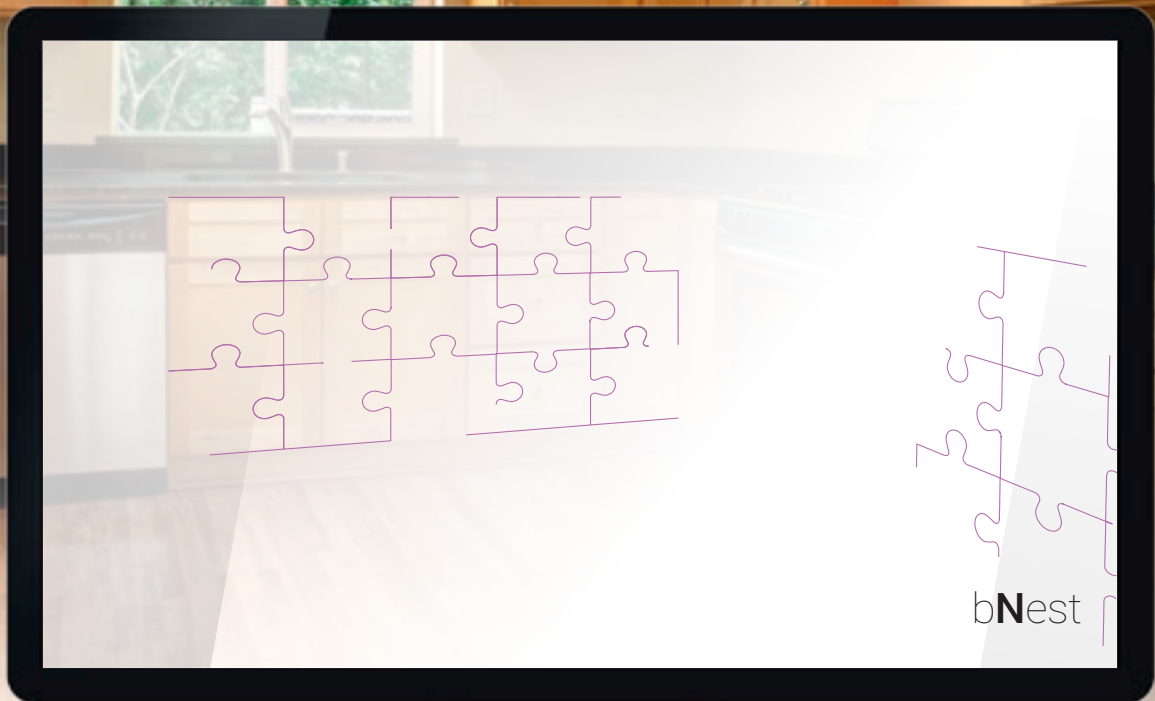

Ideas take form and shape



bCabinet is the bSuite plugin for furniture design. It allows users to develop designs for a given space, and to quickly identify the individual elements that make it up.

- ▶ **With the new plugin, it is easy to draw both individual items of furniture and complete furnishings for a range of spaces.**
- ▶ **Offering optimal integration with bSuite, users can move from design to manufacturing in just a few clicks.**
- ▶ **Total control and maximum optimisation of the furniture design and creation process, to achieve the highest levels of efficiency.**

bCabinet



bCabinet

Technical data

Working field and height Z

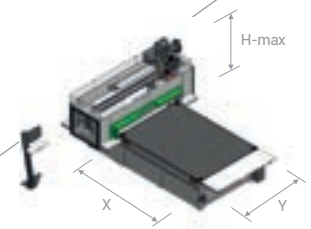

	X	Y	Z
	mm / inch		
			senza / con SWEEPER ARM
ROVER K FT 1224	2465 / 97	1260 / 50	170 / 7
ROVER K FT 1236	3765 / 148	1260 / 50	
ROVER K FT 1531	3100 / 122	1560 / 61	
ROVER K FT 1536	3765 / 148	1560 / 61	
ROVER K FT 1836	3765 / 148	1875 / 74	
ROVER K FT 2231	3100 / 122	2205 / 87	
ROVER K FT 2243	4300 / 169	2205 / 87	

Speed

	X	Y	Z	
m/min	25	25	25	Low speed
foot/min	82	82	82	
m/min	60	60	25	High speed
foot/min	196,9	196,9	82	

Vector speed

m/min	35	Low speed
foot/min	116	
m/min	85	High speed
foot/min	278,4	

Working dimensions

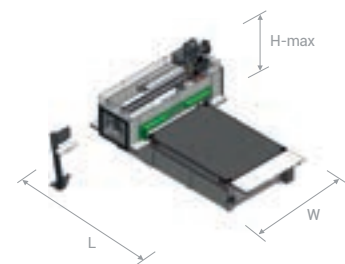

Stand-alone machine - low speed

	L	W	H	H-max
	mm / inch			
	NCE - CE			
ROVER K FT 1224	5911 / 233	3587 / 141	985 / 39	2508 / 99
ROVER K FT 1236	7211 / 284	3587 / 141		
ROVER K FT 1531	6546 / 258	3887 / 153		
ROVER K FT 1536	7211 / 284	3887 / 153		
ROVER K FT 1836	7211 / 284	4207 / 166		
ROVER K FT 2231	6546 / 258	4517 / 178		
ROVER K FT 2243	7746 / 305	4517 / 178		

Working dimensions

Stand-alone machine - high speed

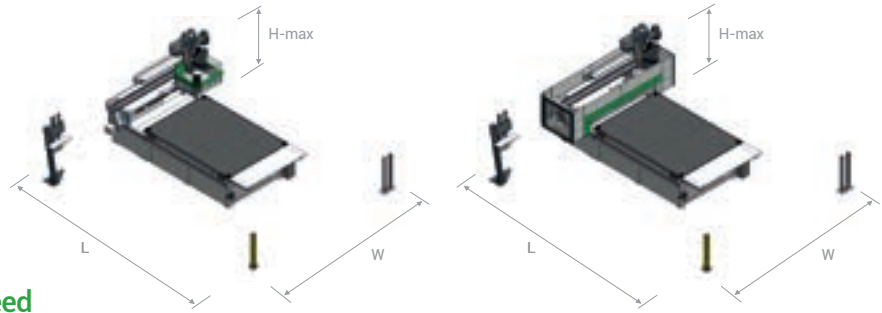

	L		W		H	H-max
	mm / inch					
	NCE	CE	NCE	CE		
ROVER K FT 1224	6129 / 241	6263 / 247	3751 / 148	4153 / 164	966 / 38	2210 / 87
ROVER K FT 1236	7429 / 292	7563 / 298	3751 / 148	4153 / 164		
ROVER K FT 1531	6764 / 266	6898 / 272	4051 / 159	4453 / 175		
ROVER K FT 1536	7429 / 292	7563 / 298	4051 / 159	4453 / 175		
ROVER K FT 1836	7429 / 292	7563 / 298	4371 / 172	4773 / 188		
ROVER K FT 2231	6764 / 266	6898 / 272	4681 / 184	5083 / 200		
ROVER K FT 2243	7964 / 314	8098 / 319	4681 / 184	5083 / 200		

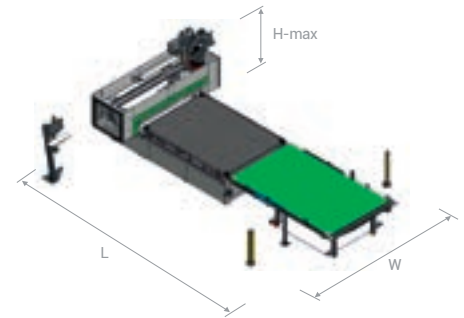

Machine with unloading belt - high speed*

	L		W		H	H-max
	mm / inch					
	NCE - CE		NCE	CE		
ROVER K FT 1224	8584 / 338		3751 / 148	4153 / 164	985 / 39	2508 / 99
ROVER K FT 1236	9884 / 389		3751 / 148	4153 / 164		
ROVER K FT 1531	9219 / 363		4051 / 159	4453 / 175		
ROVER K FT 1536	9884 / 389		4051 / 159	4453 / 175		
ROVER K FT 1836	9884 / 389		4371 / 172	4773 / 188		
ROVER K FT 2231	9219 / 363		4681 / 184	5083 / 200		
ROVER K FT 2243	10419 / 410		4681 / 184	5083 / 200		

* Where the version is a low speed one (NCE or CE), the whole width W is 560 mm lower than the CE value indicated.

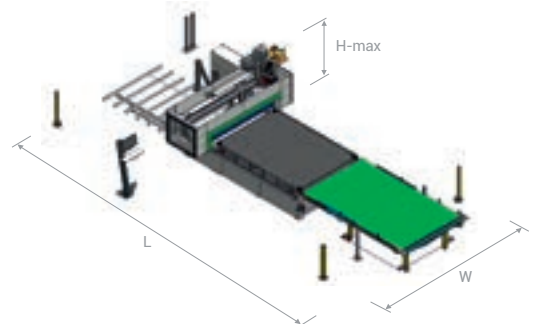

Machine in complete nesting cell - high speed

	L		W		H	H-max
	mm / inch					
	NCE - CE		NCE	CE		
ROVER K FT 1224	11863 / 467		4140 / 163	4342 / 171	985 / 39	2508 / 99
ROVER K FT 1236	13163 / 518		4140 / 163	4342 / 171		
ROVER K FT 1531	12498 / 492		4440 / 175	4642 / 183		
ROVER K FT 1536	13163 / 518		4440 / 175	4642 / 183		
ROVER K FT 1836	13163 / 518		4760 / 187	4962 / 195		
ROVER K FT 2231	12498 / 492		5070 / 200	5272 / 208		
ROVER K FT 2243	13698 / 539		5070 / 200	5272 / 208		

Configuration

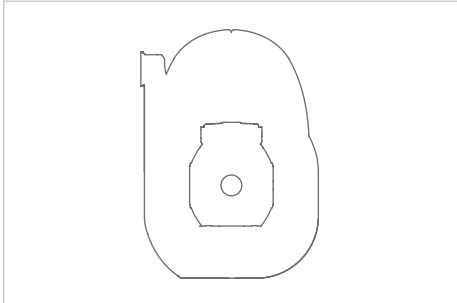

Milling unit for all applications.

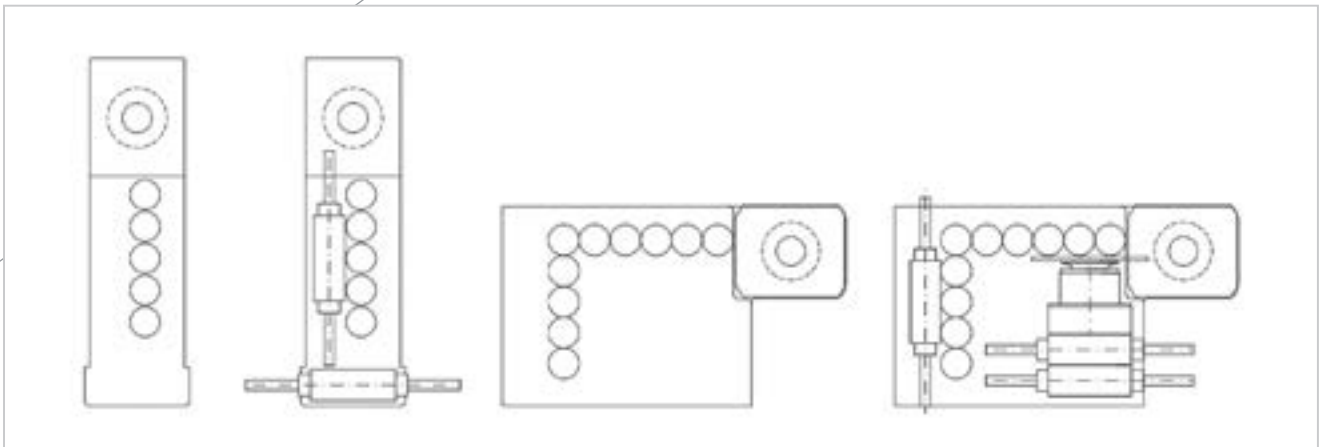

Boring heads available with 5 to 17 positions: BH5 - BH9 - BH10 - BH17 L.

The technical specifications and drawings are non-binding. Some photos may show machines equipped with optional features. Biesse Spa reserves the right to carry out modifications without prior notice.

Weighted sound pressure level A (LpA) during machining at the operator's workstation on the vane-pump machine Lpa=79dB(A) Lwa=96dB(A) Weighted sound-pressure level A (LpA) at the operator's workstation and sound power level (Lwa) during machining on the cam-pump machine Lwa=83dB(A) Lwa=100dB(A) Measurement uncertainty K dB(A) 4.

The measurement was carried out in compliance with UNI EN 848-3:2007, UNI EN ISO 3746: 2009 (sound power) and UNI EN ISO 11202: 2009 (sound pressure levels at workstation) during panel machining. The noise levels shown are emission levels and do not necessarily correspond to safe operation levels. Despite the fact that there is a relationship between emission and exposure levels, this may not be used in a reliable manner to establish whether further measures need to be taken. The factors determining the exposure level for the workforce include length of exposure, work environment characteristics, other sources of dust and noise, etc. i.e. the number of other adjoining machines and processes. At any rate, the above information will enable the operator to better evaluate dangers and risks.

Machining centres range

CNC - ROUTING

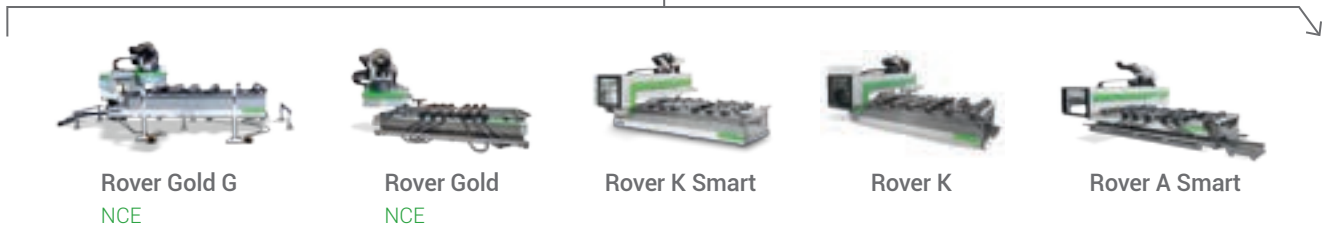

CNC - ROUTING

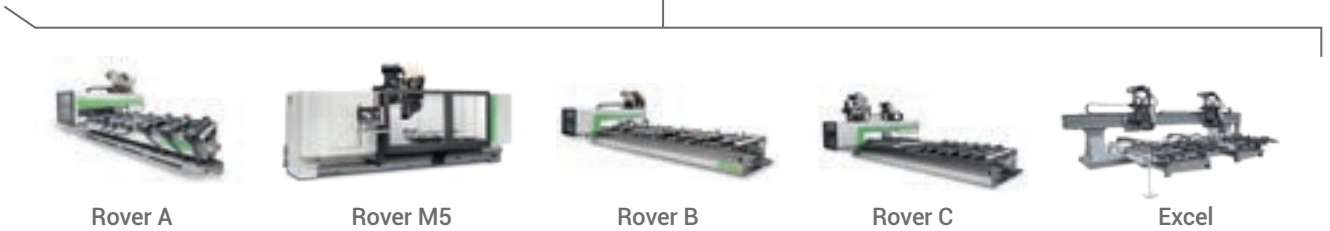

CNC - EDGEBANDING

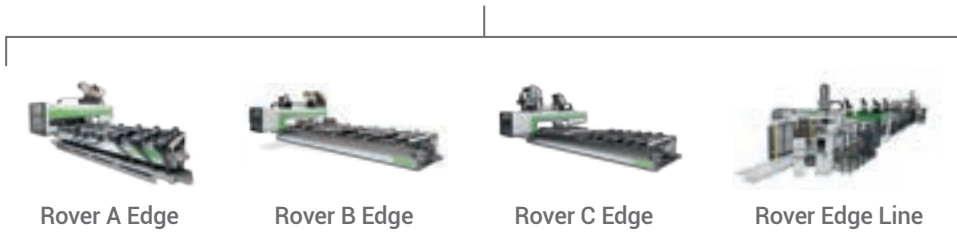

CNC - NESTING

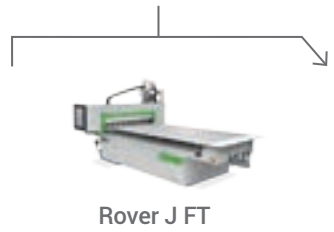

CNC - NESTING

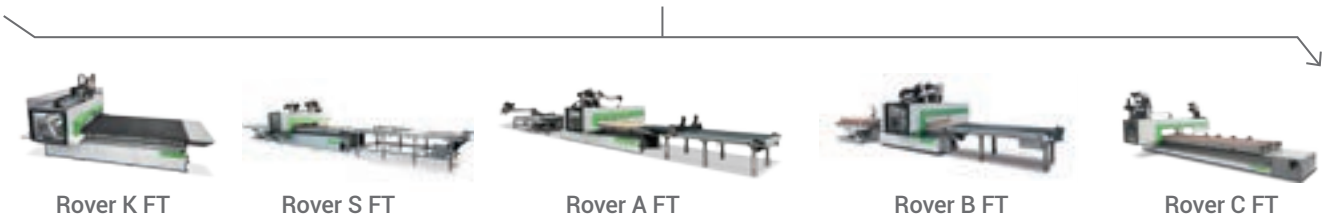

CNC - NESTING

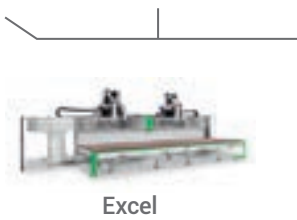

CNC - WINDOWS AND DOORS



CNC - BORING

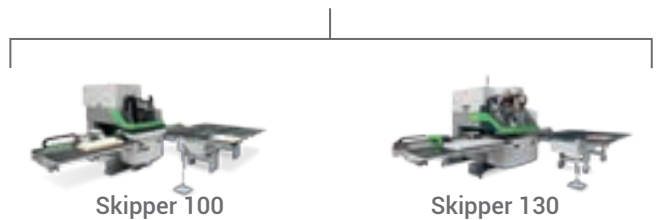

Service & Parts

Direct, seamless co-ordination of service requests between Service and Parts.
Support for Key Customers by dedicated Biesse personnel, either in-house and/or at the customer's site.

Biesse Service

- ▶ Machine and system installation and commissioning.
- ▶ Training centre dedicated to Biesse Field engineers, subsidiary and dealer personnel; client training directly at client's site.
- ▶ Overhaul, upgrade, repair and maintenance.
- ▶ Remote troubleshooting and diagnostics.
- ▶ Software upgrade.

500 / Biesse Field engineers in Italy and worldwide.

50 / Biesse engineers manning a Teleservice Centre.

550 / certified Dealer engineers.

120 / training courses in a variety of languages every year.

The Biesse Group promotes, nurtures and develops close and constructive relationships with customers in order to better understand their needs and improve its products and after-sales service through two dedicated areas: Biesse Service and Biesse Parts.

With its global network and highly specialised team, it offers technical service and machine/component spares anywhere in the world on-site and 24/7 on-line.



Biesse Parts

- ▶ Original Biesse spares and spare kits customised for different machine models.
- ▶ Spare part identification support.
- ▶ Offices of DHL, UPS and GLS logistics partners located within the Biesse spare part warehouse, with multiple daily pick-ups.
- ▶ Order fulfilment time optimised thanks to a global distribution network with de-localised, automated warehouses.

87% / of downtime machine orders fulfilled within 24 hours.

95% / of orders delivered in full on time.

100 / spare part staff in Italy and worldwide.

500 / orders processed every day.

Made **With** Biesse

Maton and Biesse make music together.

With more than 1200 models of guitars made for thousands of professional musicians, Maton Guitars confirms its worldwide presence, becoming a truly great Australian success story. "The best guitar is the one that the market demands," states Patrick Evans, Head of Product Development at Maton. The evolution in production techniques and research into the most efficient software continues, prompting Maton to hunt for new solutions that can better respond to emerging needs. In 2008, after considering the pros and cons of a range of manufacturers, Maton chose Biesse. Maton's production needs incorporate technological requirements and artisan skills; the right balance of these two allows them to achieve the highest levels of quality and performance. A great guitar is both a work of art and a fine musical instrument. To obtain these results, the right tools are crucial - both for heavy machining operations and delicate processes, to create 3D shapes and work with minimal tolerances. Biesse has provided Maton with a range of advanced solutions for machining processes, not only adding quality to the products, but also providing the skilled craftsmen with more time to devote to manual finishes, ensuring that every product is unique.

In 1995, the company installed their first CNC machine. They now have two nesting centres in tandem. The Rover C is the ideal machine for high-precision nesting operations, but also for creating complex shapes, such as the body of Maton's unique guitars. The machine's newly-designed cabin provides excellent visibility of all working units. Biesse is much more than a manufacturer of machinery for producing kitchens. Their impressive range of machines can process an astounding range of materials and products. "In creative hands," commented Patrick Evans, "Biesse becomes the instrument of a true craftsman. The key is to identify the right machine for the job. We found we can accomplish much more than we thought on a Biesse machine." Maton also uses the two Biesse machines to create new product prototypes; the most complex shapes, and almost every individual part which makes up a Maton guitar. Patrick confirms that Maton uses the Biesse CNC machine at high speeds even on the most complex parts, such as the magnificent fingerboard. "We need enough flexibility to be able to switch from one model to another very quickly, and Biesse allows us to do this very effectively." Biesse gives users the creative freedom to produce virtually

any concept, both quickly and efficiently. "With the Biesse's CNC machine," Patrick continues, "you can turn your ideas into reality much faster. Thanks to the flexibility provided by Biesse machines, we can produce two fingerboard prototypes in seven minutes! If we made them by hand, it would take a whole day. Using Biesse machines has allowed us to create eight new guitar models this year alone." Using Biesse machines has allowed Maton to devote more time to the quality of the finish, wasting less time on processing individual pieces. Each Maton guitar is hand-finished by a dedicated and qualified team of luthiers. Maton has demonstrated that it is possible to produce a guitar in Australia with a worldwide reputation for quality, using Australian timber and technologies. Maton knows exactly how to design and build a unique, one-of-a-kind product, a well-made guitar, and with Biesse as valued partner, the best guitars in the world are brought to life.

Taken from an interview with Patrick Evans, head of Product Development at Maton Guitars - Australia



<http://www.maton.com.au>



Biesse Group

In / 1 industrial group, 4 divisions
and 9 production sites.

How / € 14 million p/a in R&D
and 200 patents registered.

Where / 37 branches and 300
agents/selected dealers.

With / Customers in 120 countries (manufacturers of furniture,
design items and door/window frames, producers of ele-
ments for the building, nautical and aerospace industries).

We / 3,800 employees throughout the world.

Biesse Group is a multinational leader in the technology for processing wood, glass, stone, plastic and metal.

Founded in Pesaro in 1969, by Giancarlo Selci, the company has been listed on the STAR sector of Borsa Italiana since June 2001 and is currently a constituent of the FTSE IT Mid Cap index.

 **BIESSEGROUP**

 **BIESSE**

 **INTERMAC**

 **DIAMUT**

MECHATRONICS

