

Rover M5

NC processing centre



 **BIESSE**

When competitiveness
means producing
works of art

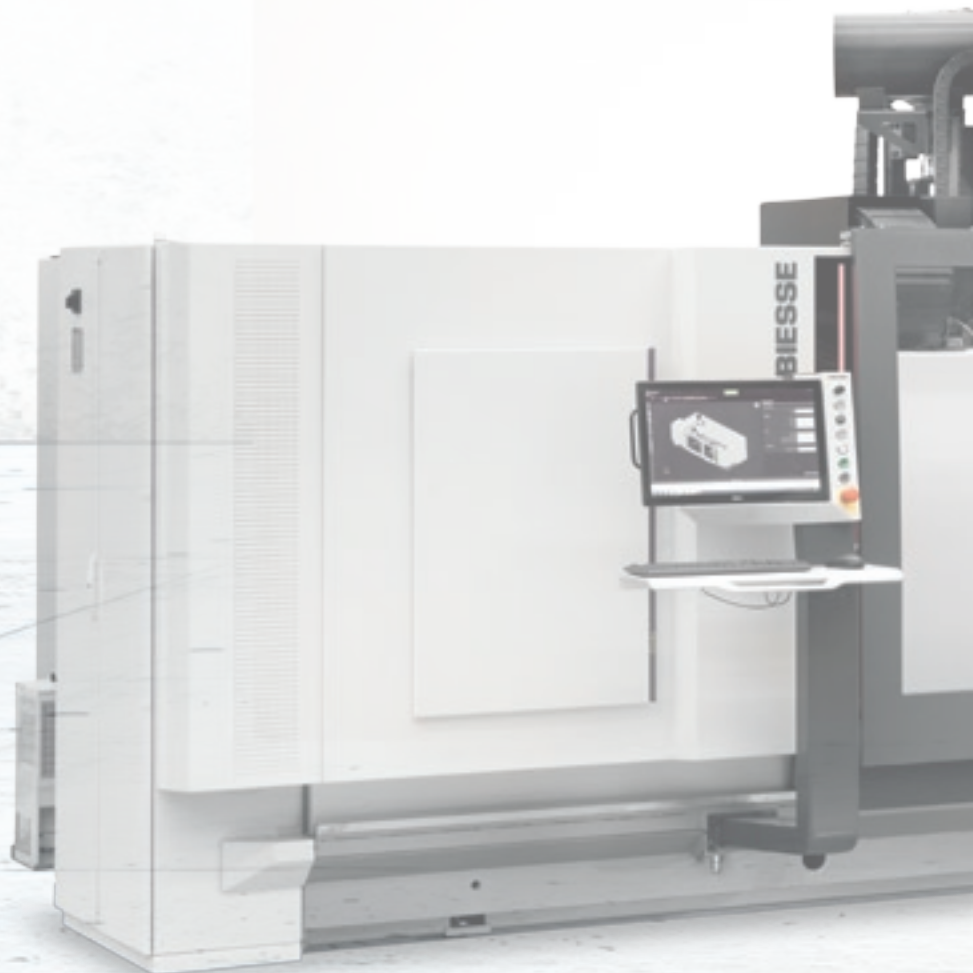

Made **In** Biesse

The market demands

a change in manufacturing processes, **enabling companies to accept the largest possible number of orders**. This is coupled with the need to maintain high quality standards and product customisation with **quick and defined delivery times**, as well as responding to the needs of the most creative architects.

Biesse answers

with **technological solutions** that enhance and support technical expertise as well as process and material knowledge.

Rover M5 is the machining centre designed for the creation of unusual, unique products, larger objects and design pieces. With technology which is totally unique in its field, designed for the most demanding machining operations, at an affordable cost.

- ▶ **A totally unique approach the passage of workpieces.**
- ▶ **Multiple tooling options for locking complex shapes securely in place.**
- ▶ **Increased visibility in total safety.**
- ▶ **All three dimensions are ergonomic and compact.**

Technology for artisan businesses



Rover **M5**
NC processing centre



A totally unique approach the passage of workpieces

**Panels measuring up to 536 mm in height
can be loaded onto the machine.**



Exceptional finish quality

**Biesse uses the same high-tech components
for all machines in the Rover range.**



Electrospindles, boring heads and aggregates are designed and manufactured for Biesse by HSD, the global leader in the mechatronics sector.



13 kW of power, even at just 12,000 rpm, with "endless" A and C axis rotation to avoid restarts on the piece.

BHZ 17 L
17 tools with rotation up to 6,000 rpm - can be adjusted via the inverter for top boring quality and precision.

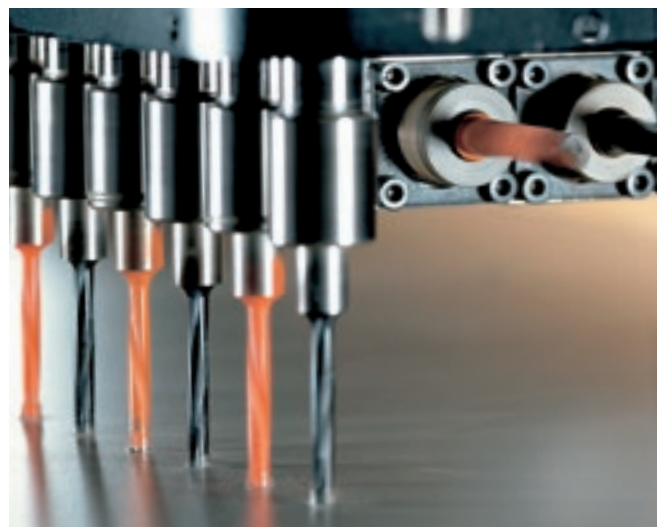

User-friendly technology

The 5-axis operating head, equipped with 13 kW HSD spindle and with 360° continuous rotation on the vertical and horizontal axes, enables the machining of complex-shapes ensuring quality, precision and absolute long term reliability.

5 AXES

The high technological content of the world's most popular machining centres, meets the requirements of wood industry professionals. A perfect combination of Biesse innovation and Italian genius.

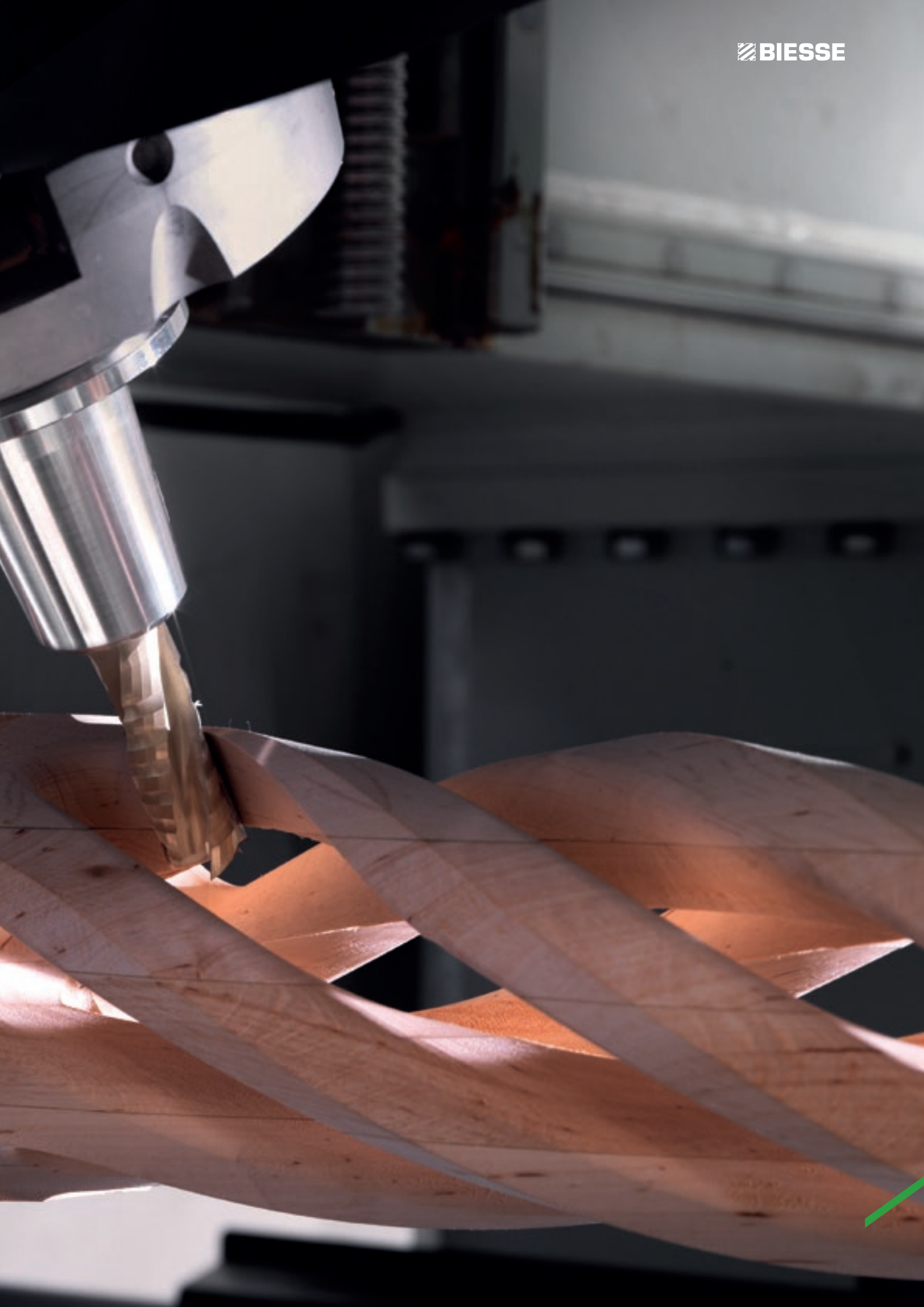

Multiple tooling options for locking complex shapes securely in place

The work table can be customised according to machining requirements, allowing high-volume pieces, moulds etc. to be securely locked in place. The machine can be equipped with any type of tool, for processing even the most unique and unusual pieces.



- 3 possible solutions:
- ▶ 4 or 6 ATS work tables with SA (Set Up Assistance).
 - ▶ 4 UFT (Universal Flat Table) work tables.
 - ▶ Combined solution with 3 ATS work tables and 2 UFT work tables.



Module for vacuum locking system.



SA (Set Up Assistance)

The assisted set-up work table suggests to the operator how to position the panel, (indicating the position of work tables and blocking systems) and protects the work area from any collisions with the tool.

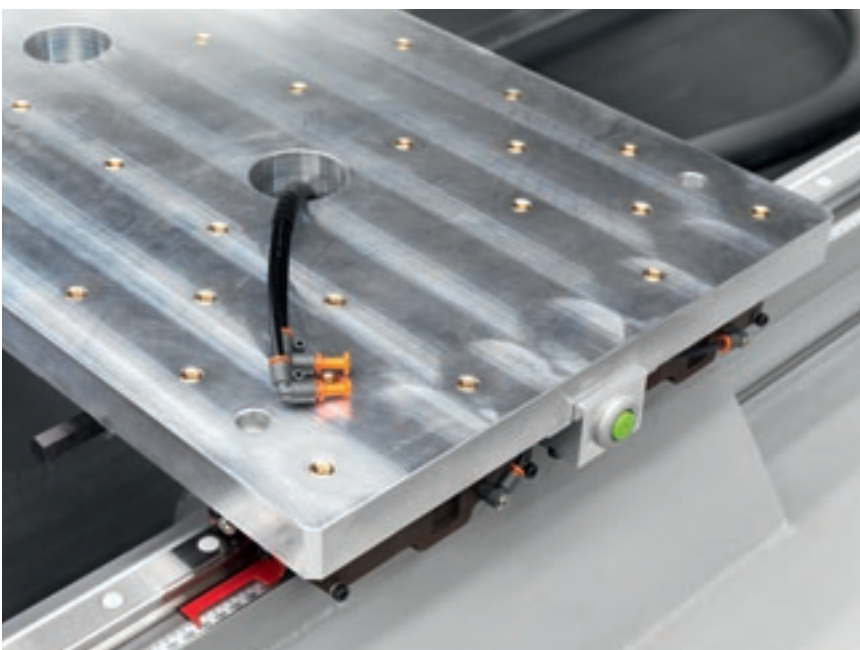

UFT (Universal Flat Table) work table in aluminium with holes for attaching customised locking systems.

Exclusive technology



The Rover M5 work table allows for pieces measuring up to 535 mm in height to be loaded. Can be customised according to requirements, and equipped with any type of tool, to lock even parts with more complex shapes firmly in place. The Rover M5 is extremely compact and offers high levels of performance, with a working field of 3200x1600x536 mm in a space of 6440x2825x2640 (everything included).

The background of the page is a close-up photograph of a wooden workpiece being processed by a machine. The machine's head, with various metal components and a black handle, is visible in the upper left. The wood is light-colored and has a smooth, curved edge. The lighting is dramatic, highlighting the texture of the wood and the metallic parts of the machine.

ROVER M5

A work table which is totally unique in its category, for machining high volume items or particularly delicate three-dimensional shapes. A perfect combination of Biesse flexibility and Italian genius.

Increased visibility in total safety

The machine encasing allows the operator to follow the machining operation in complete safety, ensuring a full view of the machine.



The encasing on this type of machine enables machining operations on delicate, three-dimensional objects, without any risk of damage to the workpiece.

Tailored solutions for a perfect finish

Constant attention to ensuring that the panel remains clean, guaranteeing high quality standards. Proven technology that lasts.



Motorised **conveyor belt** for the removal of chips and waste.

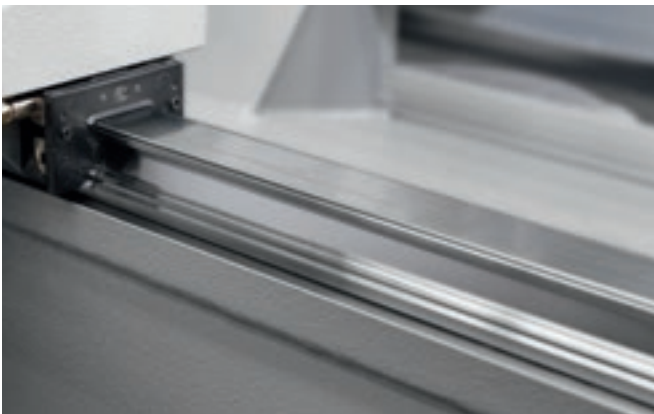

The **linear guides** on the X axes are covered with a protective laminate and an additional set of dust guards is installed on the pads of the slides to ensure that the machine movement system is fully protected.



The Y, X and Z axes are equipped with **enclosed cable-holder chains** - particularly useful when processing materials which could damage cables and compressed air hoses.

The most advanced technology close at hand



bPad

Wi-Fi control console for performing the key functions required during the preparation of the working area and the tooling of the working units and tool holder warehouses.

The bPad is a valuable tool for supporting teleservicing, courtesy of the camera and bar code reader functions.

bTouch

The new 21.5" touch screen which enables you to carry out all of the functions previously performed using the mouse and the keyboard, enhancing the direct interaction between the user and the device. Perfectly integrated with the bSuite 3.0 interface (and with later versions) and optimised for touch, this solution is incredibly simple, and makes the best possible use of the Biesse software functions installed on the machine.

bPad and bTouch are an optional feature which can also be bought after purchasing the machine, in order to improve the functionality and application of the technology available.



Industry 4.0 ready



Industry 4.0 is the new industry frontier, based on digital technologies and on machines that speak to companies. The products driving this revolution can communicate and interact independently within production processes, which in turn are connected via intelligent networks.



Biesse is dedicated to transforming the factories owned by our customers into real-time factories that are ready to provide digital manufacturing opportunities. Intelligent machines and software become indispensable tools that facilitate the daily work of those who machine wood and other materials on a daily basis.

High-tech becomes accessible and intuitive



bSolid is a 3D cad cam software program that supports the performance of any machining operation thanks to vertical modules designed for specific manufacturing processes.

- ▶ **Planning in just a few clicks, with endless possibilities.**
- ▶ **Simulating machining operations to visualise the piece ahead of manufacturing and have some guidance for the planning phase.**
- ▶ **Virtual prototyping of the piece to avoid collisions and ensure optimal machine equipment.**

Watch the **bSolid** ad at: youtube.com/biessegroup



bSolid



Ergonomics and compactness on three dimensions

The Rover M5 has been developed to make moving around the machine as easy as possible for the operator.



Maximum ease of tooling.

1 revolving magazine with 16 standard positions, which can be accessed through the opening in the cab, along with an optional 16 position revolving magazine which can be tool via the 5-axis group.



Integrated control unit in the cab.

The encasing also incorporates the 5 axis cooling system, ensuring that the overall dimensions of the machine remain compact.



Technical data

The Rover M5 can be installed even in the smallest of spaces.

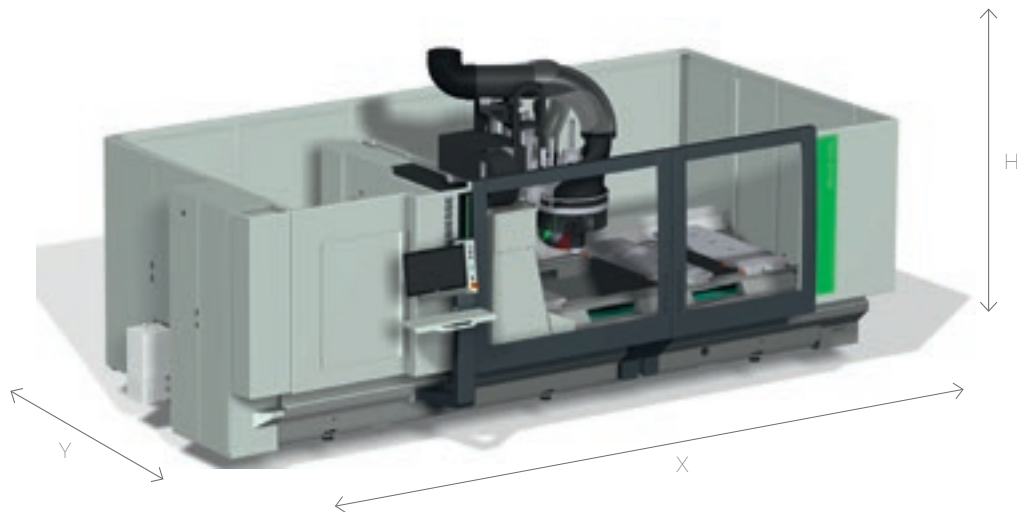

Working fields

X	Y	Z
mm	mm	mm
3200	1600	358 - 536

Machine dimensions

X	Y	H
mm	mm	mm
6440	2825	2640

X/Y/Z axis speed	m/min	80 / 80 / 20
Vector speed	m/min	100

The technical specifications and drawings are non-binding. Some photos may show machines equipped with optional features. Biesse Spa reserves the right to carry out modifications without prior notice.

Weighted sound pressure level A (LpA) during machining at the operator's workstation on the vane-pump machine Lpa=83dB(A) Lwa=106dB(A) Weighted sound-pressure level A (LpA) at the operator's workstation and sound power level (LwA) during machining on the cam-pump machine Lwa=83dB(A) Lwa=106dB(A) Measurement uncertainty K dB(A) 4.

The measurement was carried out in compliance with UNI EN 848-3:2007, UNI EN ISO 3746: 2009 (sound power) and UNI EN ISO 11202: 2009 (sound pressure levels at workstation) during panel machining. The noise levels shown are emission levels and do not necessarily correspond to safe operation levels. Despite the fact that there is a relationship between emission and exposure levels, this may not be used in a reliable manner to establish whether further measures need to be taken. The factors determining the exposure level for the workforce include length of exposure, work environment characteristics, other sources of dust and noise, etc. i.e. the number of other adjoining machines and processes. At any rate, the above information will enable the operator to better evaluate dangers and risks.

SOPHIA

GREATER VALUE FROM MACHINES



SOPHIA IS THE BIESSE IOT PLATFORM WHICH ENABLES CUSTOMERS TO ACCESS AN EXTENSIVE RANGE OF SERVICES TO STREAMLINE AND RATIONALISE THEIR WORK MANAGEMENT PROCESSES.

IT IS BASED ON THE ABILITY TO SEND REAL-TIME INFORMATION AND DATA ON THE TECHNOLOGIES IN USE, OPTIMISING THE PERFORMANCE AND PRODUCTIVITY OF MACHINES AND SYSTEMS. IT CONSISTS OF TWO AREAS: IOT AND PARTS.

- **REDUCED PRODUCTION TIME**
- **LOWER COSTS**
- **REDUCTIONS IN MACHINE DOWNTIME**
- **OPTIMISATION OF THE PRODUCTION PROCESS**
- **INCREASE IN PRODUCTIVITY**
- **MAXIMUM QUALITY OF DAILY WORK**

The various functions of the **iOT** app offer a comprehensive overview of the specific machine performance features, with remote diagnostics, machine stoppage analysis and fault prevention.

PARTS is the new replacement parts web portal which allows users to navigate within a personalised account, providing access to all the information on purchases and enabling a replacement parts shopping cart to be submitted, and the progress of orders to be monitored.

Service & Parts

Direct, seamless co-ordination of service requests between Service and Parts. Support for Key Customers by dedicated Biesse personnel, either in-house and/or at the customer's site.

Biesse Service

- ▶ Machine and system installation and commissioning.
- ▶ Training centre dedicated to Biesse Field engineers, subsidiary and dealer personnel; client training directly at client's site.
- ▶ Overhaul, upgrade, repair and maintenance.
- ▶ Remote troubleshooting and diagnostics.
- ▶ Software upgrade.

500 / Biesse Field engineers in Italy and worldwide.

50 / Biesse engineers manning a Teleservice Centre.

550 / certified Dealer engineers.

120 / training courses in a variety of languages every year.

The Biesse Group promotes, nurtures and develops close and constructive relationships with customers in order to better understand their needs and improve its products and after-sales service through two dedicated areas: Biesse Service and Biesse Parts.

With its global network and highly specialised team, it offers technical service and machine/component spares anywhere in the world on-site and 24/7 on-line.



Biesse Parts

- ▶ Original Biesse spares and spare kits customised for different machine models.
- ▶ Spare part identification support.
- ▶ Offices of DHL, UPS and GLS logistics partners located within the Biesse spare part warehouse, with multiple daily pick-ups.
- ▶ Order fulfilment time optimised thanks to a global distribution network with de-localised, automated warehouses.

92%  of downtime machine orders fulfilled within 24 hours.

96%  of orders delivered in full on time.

100  spare part staff in Italy and worldwide.

500  orders processed every day.

Made **With** Biesse

Biesse Group technologies join forces with Lago's innovation and total quality management processes.

In the crowded world of domestic design, Lago takes its place as an emerging brand, thanks to a collection of stimulating products and a corporate philosophy that embraces the interaction between business and art, coupled with on-going research into sustainable development. "We created a number of projects, or rather, concepts - states Daniele Lago - that have shaped Lago as we see it today: we saw design as a cultural vision that applies not only to individual products, but rather to the entire business chain". "Flexibility is the key word here at Lago" says Carlo Bertacco, Manufacturing Manager. "We started to introduce the

concept of processing only outstanding orders, which enabled us to reduce our footprint and empty the site from the very beginning". "The machinery that we purchased - states Bertacco - is great, it entailed a limited investment versus the capabilities it offers and is linked to a specific manufacturing approach. What I am talking about is a given manufacturing volume with Lago-standard quality levels and the possibility of customising as late as possible, at the customer's request: in short, the very basic principles of lean manufacturing". Lago's flexibility offers customers modular elements with which they can build

a personal space that reflects their individual character. The "Lago Interior Life" corporate philosophy, as a matter of fact, is aimed at creating empathy between interiors and the people who live in them, between environmental and inner well-being.

*Source: IDM Industria del Mobile
Lago, our customer since 1999, is one of most prestigious Italian furniture brands in the world.*



<http://www.lago.it>



Biesse Group

In / 1 industrial group, 4 divisions
and 9 production sites.

How / € 14 million p/a in R&D
and 200 patents registered.

Where / 37 branches and 300
agents/selected dealers.

With / Customers in 120 countries (manufacturers of furniture,
design items and door/window frames, producers of ele-
ments for the building, nautical and aerospace industries).

We / 4,000 employees throughout the world.

Biesse Group is a multinational leader in the technology for processing wood, glass, stone, plastic and metal.

Founded in Pesaro in 1969, by Giancarlo Selci, the company has been listed on the STAR sector of Borsa Italiana since June 2001 and is currently a constituent of the FTSE IT Mid Cap index.

 **BIESSEGROUP**

 **BIESSE**

 **INTERMAC**

 **DIAMUT**

MECHATRONICS

