

As of now with BOOMERANG®
return systems, starting on page 18

Edge banding machines Ambition 1430 - 1440 KDF 440 edition



HOMAG Group

Success through partnership

To survive in a fiercely competitive market, a company has to have fast, flexible and efficient production.

The HOMAG Group, with its sales and service network in over 90 countries around the world, offers you and your employees a strong partnership no matter where you are.

The HOMAG Group of companies cover all areas of woodworking and wood-processing.

Panel sizing, sawing, edge technology, transportation technology and handling systems are just a few of our specialties. We also offer solutions for drilling, coating technology, surface technology, plants for doors and doorframes, timber house

construction, sanding technology, automation systems, packaging equipment and software. We provide a complete and innovative range of products and services that are always the perfect solution for any requirement.

You, our customers, benefit from high precision, performance and cutting-edge technology.



BRANDT

Perfect edges for demanding customers

We offer our customers innovative and powerful edge banding machines. Efficiency and quality have the highest priority, and ensure long-term competitive advantages for you. With an annual production of over 2000 edge banding machines, we are the edge banding specialist in the HOMAG Group and the world leader in our market segment.

A high degree of standardization in combination with an advanced manufacturing process and more than 50 years of engineering experience ensure state of the art quality at a superb price-performance ratio. Our clear and structured product range is designed to meet the demands of current and future market trends.

All of our developments are focused toward practically-oriented and economic solutions that guarantee you the best possible production results.

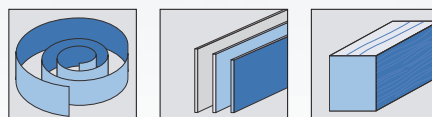

mm	Coil	Strips	Solid
a		min. 70	
b		8 - 60	
c		0,4 - 8	
d		65	
e		max. 30	

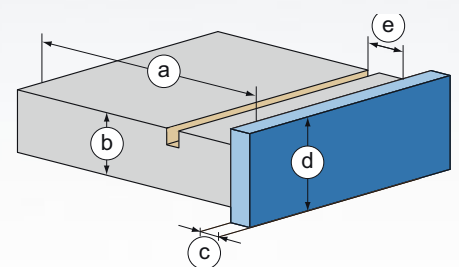

"With us, you and your products come first. A promise that you can count on!"

"Ideally prepared for your requirements"

Ambition 1430 FC - 1440 FGC

The powerful compact class

Perfect for the craftsman, as well as small and medium-sized enterprises, the ambition 1400 series provides long-term competitive advantages. In the standard version, the machine is equipped with a precision gluing unit, a tiltable end trimming unit, a multifunctional top/bottom trimming unit, a radius scraper and a buffing unit.

Depending on requirements, the machine can also be equipped with separation and detergent agent spraying units, a joint trimming unit, a Quickmelt gluing unit for more efficient production, a rough trimming unit for heavy trimming, a contour trimming unit for corner rounding, a grooving unit and a glue joint scraper.

The feed speed is 11 m / min. which can optionally be increased to 14 m / min.

without compromising the performance of the contour trimming unit.

The optionally available automation packages shorten the setup time and provide a higher level of operational convenience.



The right solution for your requirements

The Ambition 1400 series machine leaves nothing lacking. Whether your needs are "batch size one" production, for demanding bespoke shop fitting applications, living & bedroom furniture or functional office furniture, the Ambition 1400 Series always offers the right solution for your requirements.



Ambition 1440 FC



powerTouch – The new dimension in machine operation



powerTouch implements the HOMAG Group's new operating philosophy: Simple, standardized, ergonomic and evolutionary. The innovative touchscreen operating concept unites design and function to create a totally new control generation.

- 21" screen with full HD resolution
- Fast overview of machine status
- Simple, user-oriented navigation
- Traffic light assistant helps guide the user towards readiness for production
- Standardized design of the user interface
- Intuitive, natural touch operation of the machine
- Use of gestures such as swiping, scrolling

"At the focus of this solution is a large multi-touch monitor in widescreen format, which is used to control machine functions by direct touch contact. The entire user interface has been optimized for touch operation and offers an array of help and assistance functions designed to radically simplify the work experience. Standardized control elements and software modules ensure that all HOMAG

Group machines can be operated with the same familiar look and feel using this new concept. They differ only in terms of a few machine-specific details. This not only simplifies the operation of different machines, but also makes for great efficiency by significantly reducing time for servicing and training."



"Machine data capturing for maintenance depending on need and for the representation of important operating figures (e.g. number of pieces, production time, edge material quantity)"



Teleservice reduces field service work operations

- Reduction of service cost
- Avoidance of an unscheduled machine downtime
- Specific scheduling of field service work + spare parts
- Support to maintenance and operation staff

airTec - Reactivation unit

Zero joint technology for highest demands

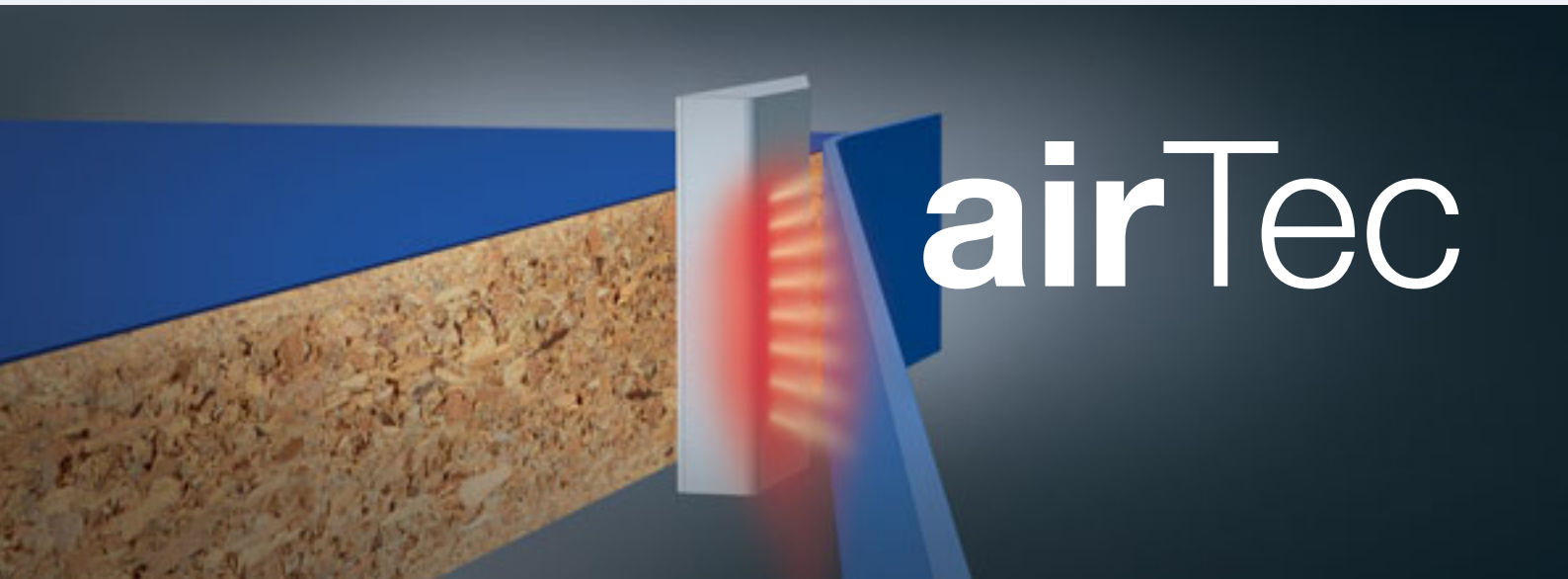

The **airTec – reactivation unit (optional)** guarantees optimal zero joints and is an industrial- and craft-oriented solution. To achieve a zero joint finish, the function layer on the edging material is reactivated by compressed hot air, providing seamless adhesion.



Unit for the activation of the functional layer on edge material, for a workpiece thickness from 8 - 40 mm. The **airTec** reactivation unit is installed in such a manner that you can work either with the standard glue application unit or with the airTec system. **airTec** can be used to process all types of currently popular, laser suitable edging types.

- Installation ex factory with complete integration into the control
- Temperature and pressure adjustable via control
- Process-specific parameters can be assigned to the corresponding programs and stored
- Indication of set and actual temperature
- The actual air consumption value depends on panel length and the gaps between the workpieces.



Spraying unit - standard

The spray unit for Antistatic solvent is included in the **airTec – reactivation unit**, to achieve a perfect finish.

Easy integration into the magazine

	Activation unit AT15
Feed speed max.	15 m/min
Workpiece thickness	8 - 40 mm
Operating pressure	4 - 6 bar
Air consumption	250 - 1.400 N/min.

*The following requirements must be provided by the customer:
- Compressed air supply 8 bars - 1 inch supply line - 1500 NI/min.

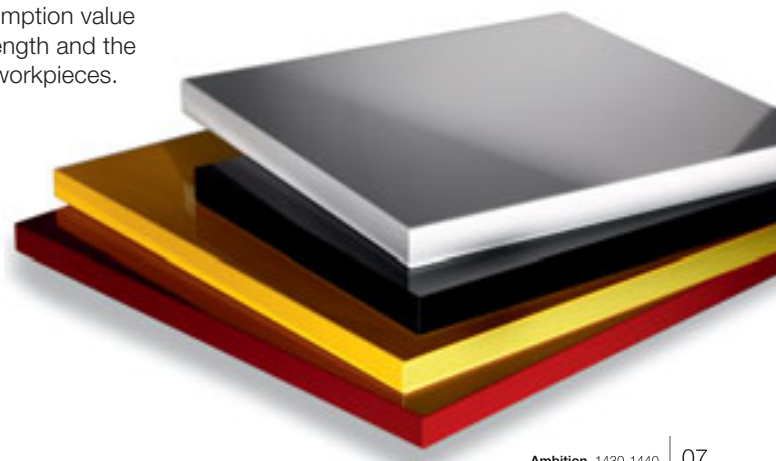

Significant competitive advantages – Pace setting performance and quality



Joint trimming unit

Perfect cut and high operating life due to diamond tipped tools for an optimum edge joint quality.

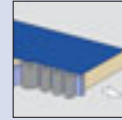

Pre-melter (optional)

On-demand availability and perfect glue quality with Quickmelt.

Gluing unit and magazine

Coil and automatic strip magazine for a reliable edgematerial supply. Optimal glue joints, by controlling the exact amount of glue.



Radiant heater

Strong adhesion through optimal pre-heating of the workpiece.

Counter pressure device

Counter pressure device magazine for sensitive edges.

Pressure zone

Heavy pressure zone up to 8 mm edge thickness and 60 mm workpiece height for an optimal glue joint.

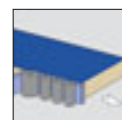



Infeed stop

For minimum workpiece spacing and safe operation.



Automatic edge infeed device (optional)

Automatic edge infeed device for fast change over between different coiled materials.

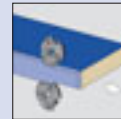

Rough trimming unit

For rough trimming of all common edge banding materials.



End-trimming unit

Precise end-cut through a strong end-trimming unit, equipped with THK guides. Chamfer/straight adjustment by easily tilting the unit. (Pneumatic adjustment optional)

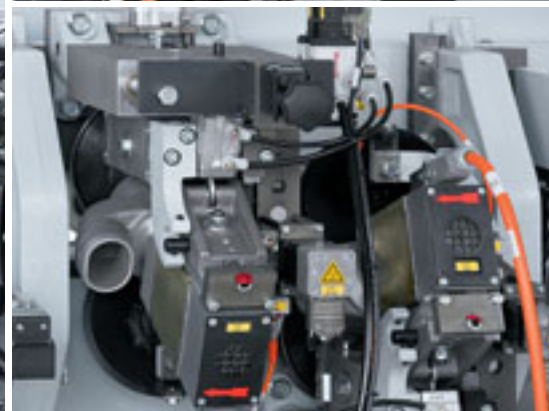
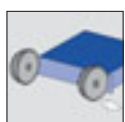

Trimming unit

Flexible adaptation to different edge thicknesses and profiles through servo axes.

Multistage trimming unit MS 40/45 (optional)

Fully automatic adjustment between 3 different profiles by means of servo motors.

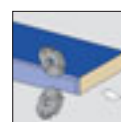

Significant competitive advantages – Pace setting performance and quality

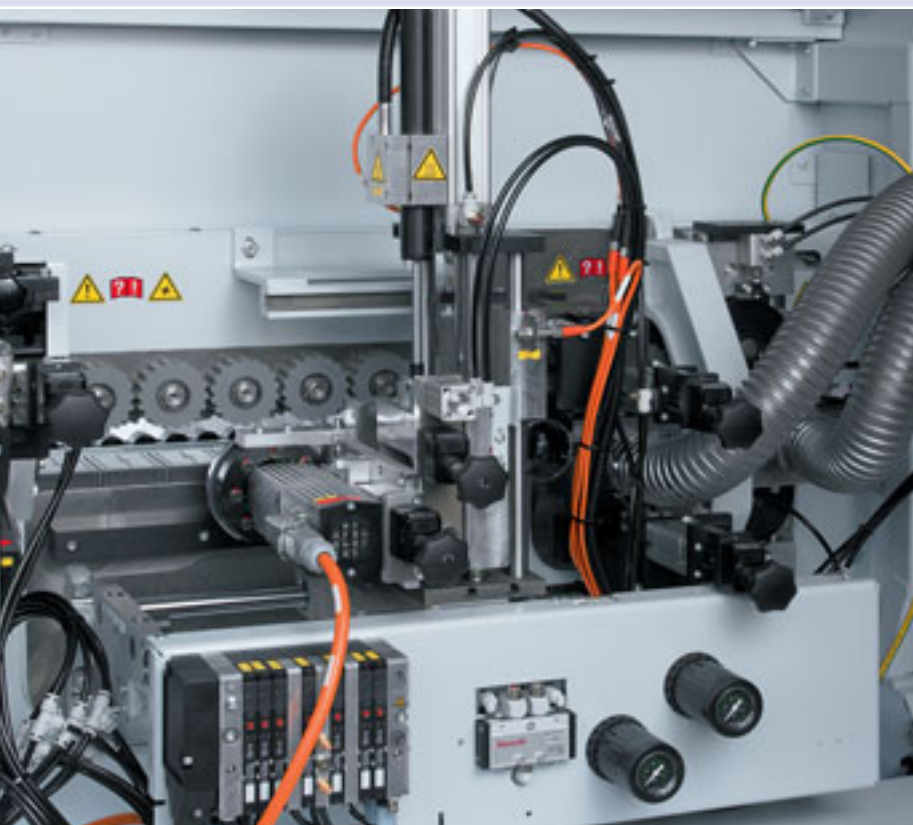

Corner rounding unit FF 10

Optimum corner rounding without adjustment or set-up, resulting from the coupled DIA tool and tracer roller.
Workpiece thickness up to 60 mm.



Corner rounding unit FF 20 (Ambition 1440 FC)

For corner rounding of thick PVC edges, as well as postforming and softforming profiles. Equipped with automatic adjustment between thin and thick edge materials. Workpiece thickness up to 60 mm.





Central lubrication unit

To lubricate the feed track guidance system to guarantee precision and a long life of the conveyor chain.



Nesting package (optional)

Includes a multi-roller tracing device for the trimming and scraping units to compensate for hinge holes.



**Multifunctional trimming unit MF 50
(optional Ambition 1440 FC)**

Trimming of the edge overhang on top and bottom side as well as contour trimming on the front and rear edges. Equipped with an automatic adjustment to switch between thick and thin edges. Workpiece thickness up to 60 mm.



Significant competitive advantages – Pace setting performance and quality

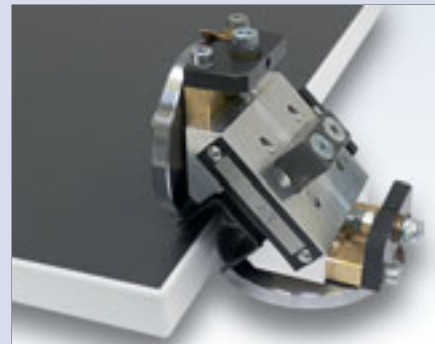

Quick adjustment for a variety of different edging material and profiles. For every demand the right changeable head.

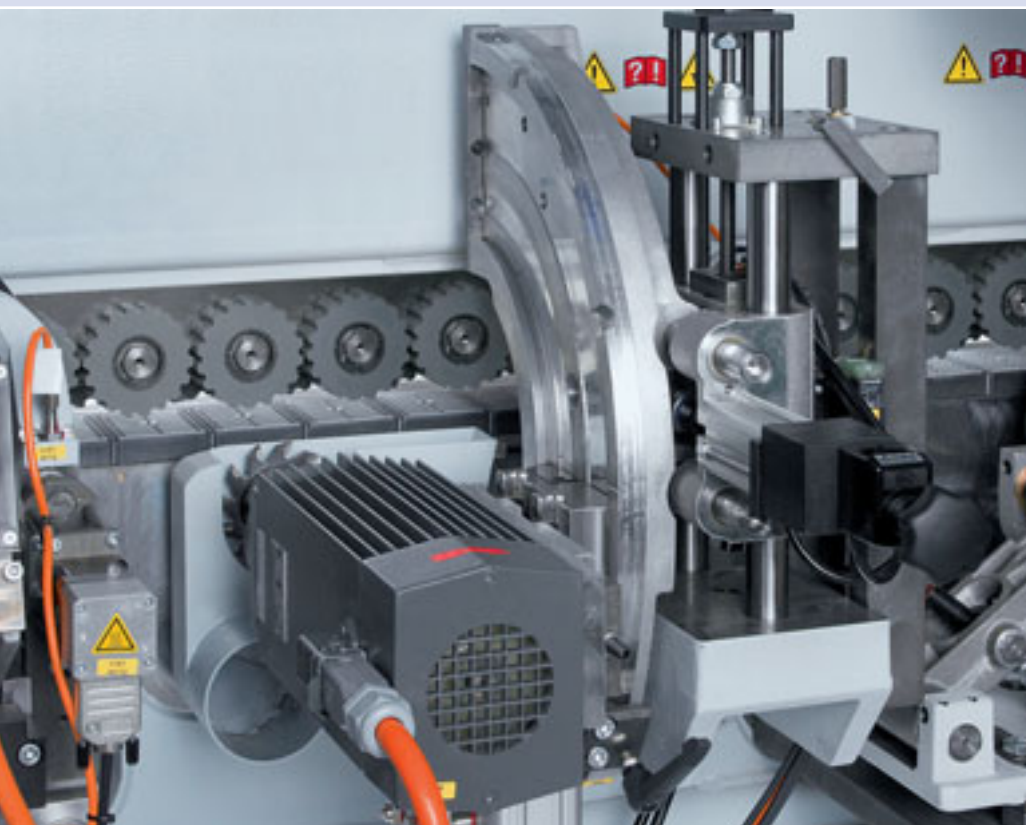

Tiltable grooving unit

For grooving work pieces either from the bottom side or from the edge side. It is possible to do either continuous grooving or non continuous grooving, as well as jump grooving for biscuit joints.



Profile scraping unit

Unit to smooth radii or chamfers, equipped with quick change heads for fast profile change.





Spraying unit (optional)

Separation and detergent agents for a perfect finish when processing PU-glue.

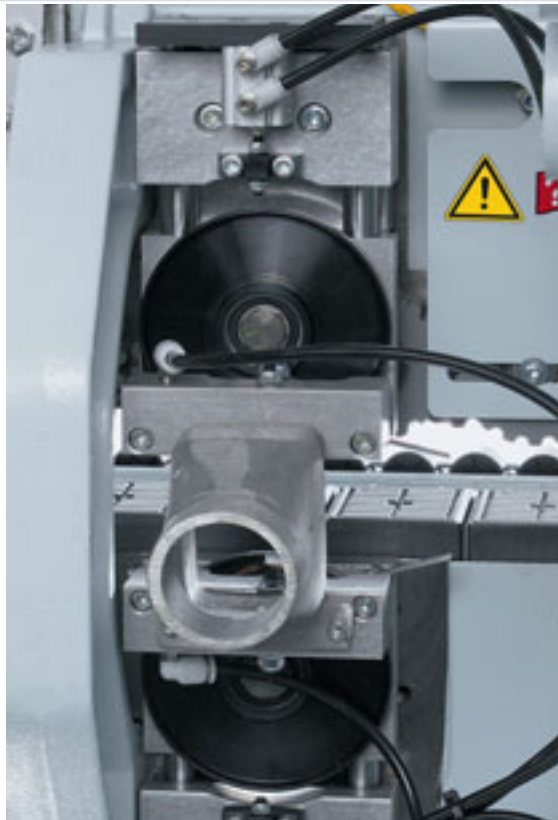

Glue joint scraping unit (optional)

For the perfect finish.

Buffing unit

Buffing unit to polish edges and maintain their natural colour.

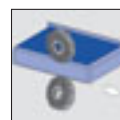
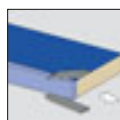

Technical Data

Type of machine	Ambition 1430 FC
Machine dimensions	
Machine length (mm)	4773
Working height (mm)	950
Machine dimensions WxH (mm)	1575 x 2182
Working dimensions	
Workpiece thickness (mm)	8 - 60
Edge material thickness (mm)	0,4 - 8
Miscellaneous	
Feed speed (m/min)	11 (optional var. 8 - 14)
Weight (kg)	1600
Connected value (kW)	12
Extraction diameter (mm)	1x120/3x80/1x100
Electrics	400 V - 3 Ph - 50 Hz
Pneumatics (bar)	6

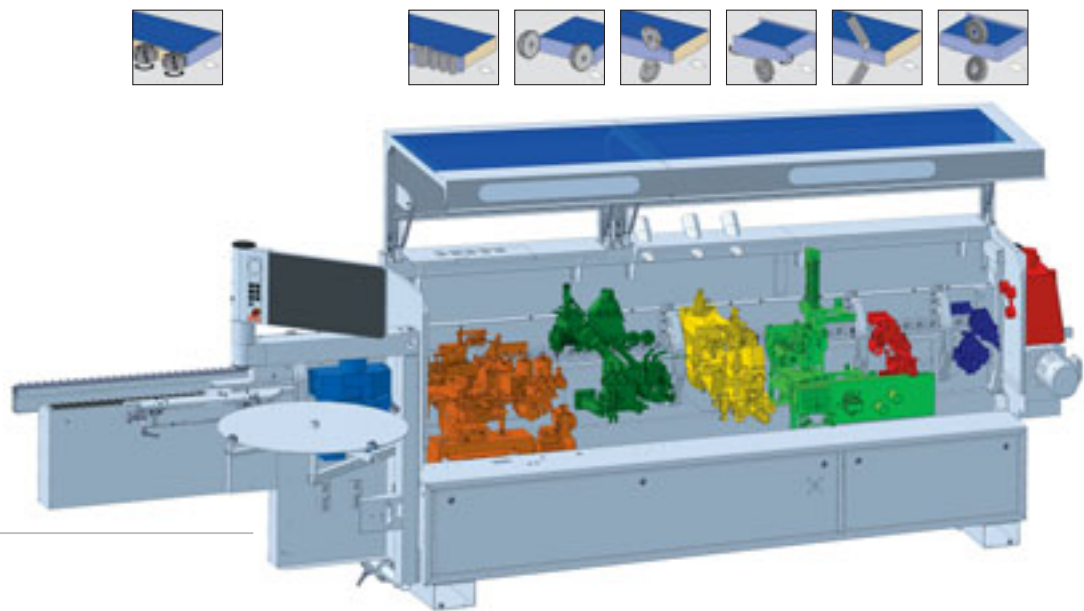

Ambition 1430 FC



Type of machine	Ambition 1440 FC	Ambition 1440 FGC
Machine dimensions		
Machine length (mm)	5273	
Working height (mm)	950	
Machine dimensions WxH (mm)	1575 x 2183	
Working dimensions		
Workpiece thickness (mm)	8 - 60	
Edge material thickness (mm)	0,4 - 8	
Miscellaneous		
Feed speed (m/min)	11 (optional var. 8 - 14)	
Weight (kg)	1850	
Connected value (kW)	12,5	16
Extraction diameter (mm)	1x120/3x80/1x100	1x120/4x80/1x100
Electrics	400 V - 3 Ph - 50 Hz	
Pneumatics (bar)	6	

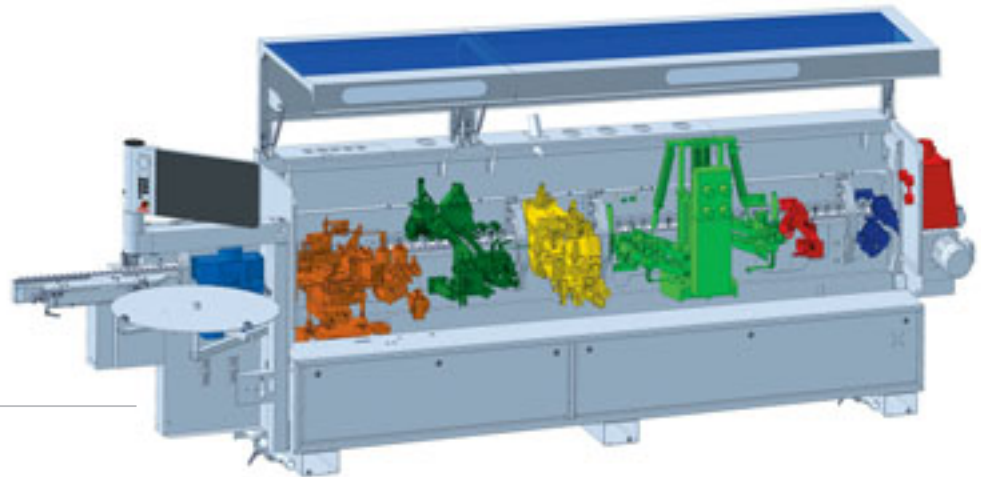

Ambition 1440 FC

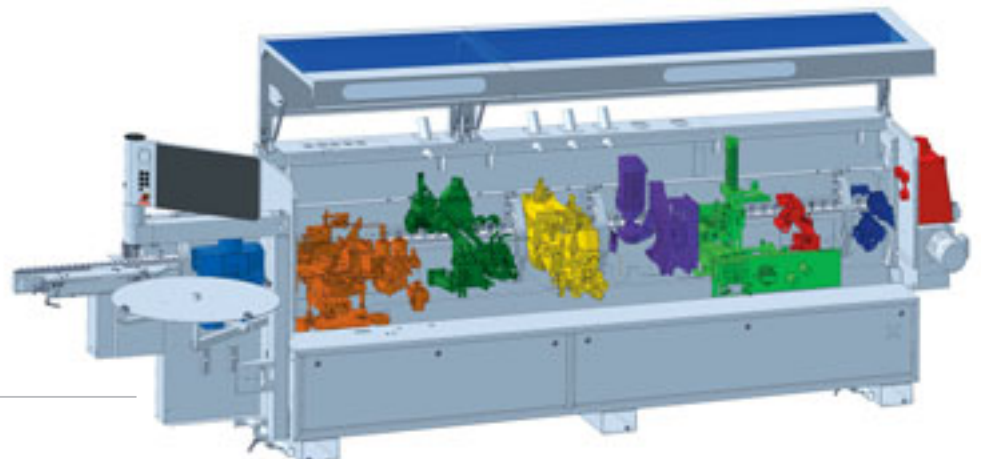

Ambition 1440 FGC

KDF 440 edition – Multistage technology as standard

The spectrum of edge and panel material is growing continuously, which means that the requirements of our customers are increasing, too. No matter what materials you use: plastic, solid wood, veneers and high gloss surfaces. The multistage trimming and scraping units always offer the ideal radius and the best results.



1. Straight

2. Profile 1

3. Profile 2

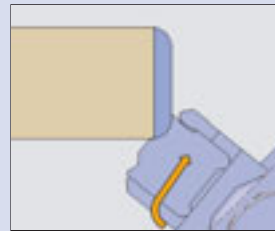

1. Profile 1

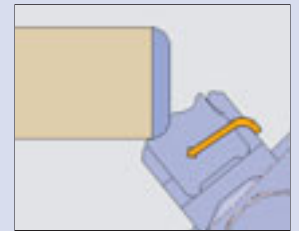

2. Profile 2



Multistage trimming unit MS 40/45 (optional)

Fully automatic adjustment between 3 different profiles by means of servo motors*.

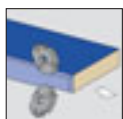

Multistage scraping unit MZ 40 (optional)

Fully automatic adjustment between 2 different profiles by means of servo motors*.

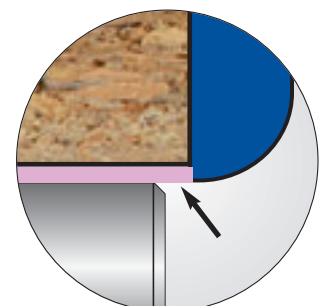
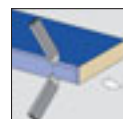

Optimal positioning for protection foil / peelcoat materials.

* **Servo motors:** The servo drive consists of a motor with an infinite adjustment. The result is high performance accuracy, especially in case of short adjusting distances.

Technical Data

Type of machine	KDF 440 edition
Machine dimensions	
Machine length (mm)	5573
Working height (mm)	950
Machine dimensions WxH (mm)	1575 x 2182
Working dimensions	
Workpiece thickness (mm)	8 - 60
Edge material thickness (mm)	0,4 - 8
Miscellaneous	
Feed speed (m/min)	var. 8 - 14
Weight (kg)	1850
Connected value (kW)	13
Extraction diameter (mm)	1x120/3x80/1x100
Electrics	400 V - 3 Ph - 50 Hz
Pneumatics (bar)	6

All rights for technical changes withheld. Individual machine pictures may show options.

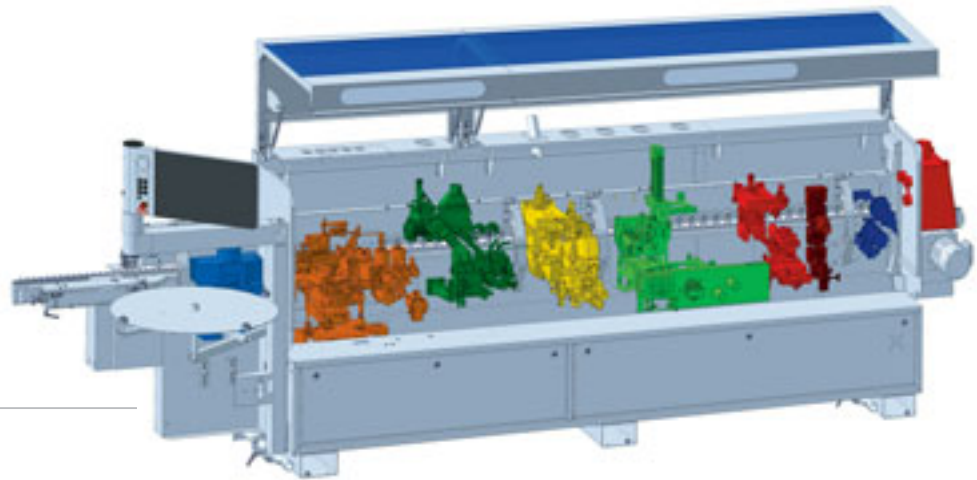
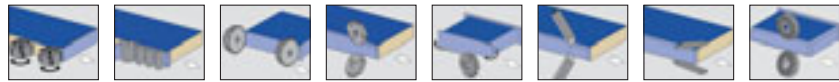

KDF 440 edition

BOOMERANG® return system TFU 120: Higher productivity for your BRANDT Edge Bander

As an indispensable assistant the return system renders your BRANDT Ambition even more economic. With the one-man-operation you optimize the workpiece return and allow a lean and efficient production process. Any combination of your BRANDT machine of the Ambition 1400 series with this return system is provided.



BOOMERANG® TFU 120

The entry to a comfortable material flow.

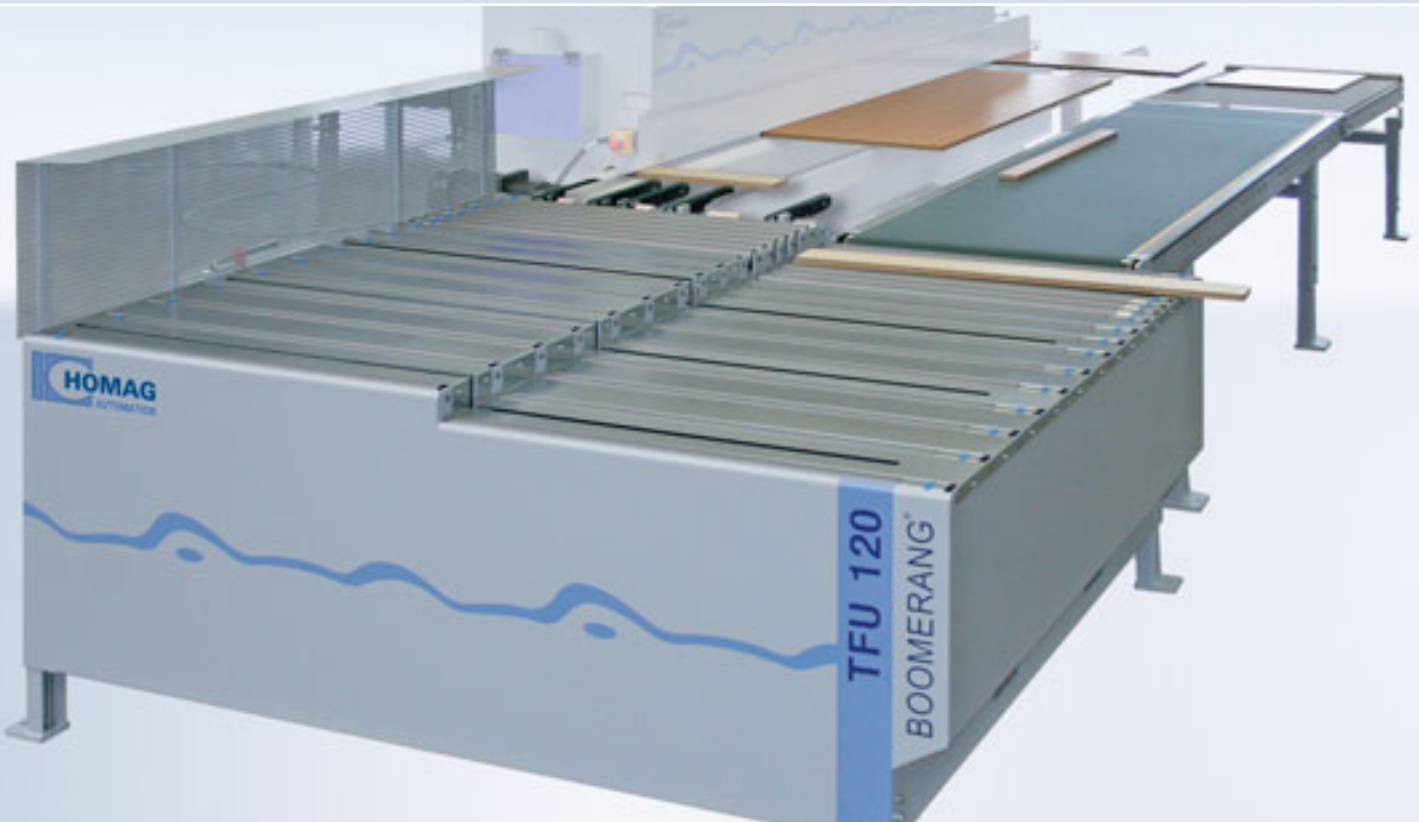

Excellently suited for customers with small, narrow, and medium-sized workpieces

The advantages at a glance:

- Fast amortization - pays off from 9 hours working time per week
- No training necessary - assemble the BOOMERANG®, connect it, and get started
- Flexible operator organization - thanks to economic one-man operation
- Ergonomic operation - operator will be released from heavy physical work
- Better quality control - fast reaction to material adjustments

	TFU 120
Workpiece length	300 - 2500 mm
Workpiece width	50 - 1450 mm
Workpiece thickness	8 - 60 mm
4-sided processing*	
min. workpiece dimension	300 x 300 mm
max. workpiece dimension	1450 x 1450 mm
Weight	max. 50 kg
Feed speed	8 - 25 m/min

*Larger workpieces can be returned or fed out for 4-sided processing with manual assistance for the transverse offset and turning.

By the way:
 The BOOMERANG® already
 pays off within one year, in fact
 starting from an operation
 of 9 hours per week!

**Sensor-controlled pivot pins
 (option)**

For easier rotation of short and narrow
 workpieces.



CE Package

Safety engineering equipment.
 For the protection of the employees.

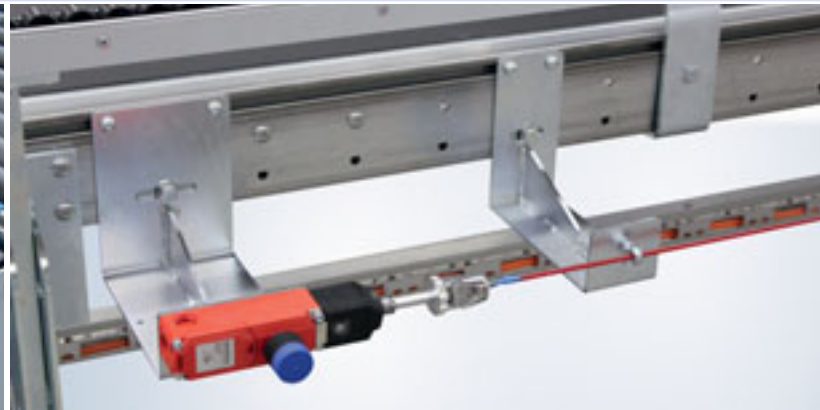

Belt cleaning

For optimal protection against dust
 and chips.



**Remote control
 (option)**

Separate control panel at the infeed of the
 edge-banding machine.



A member of the Homag Group of Companies



BRANDT
Kantentechnik GmbH
Weststraße 2
32657 Lemgo
Germany
Tel. +49 5261 974-0
Fax +49 5261 6486
info@brandt.de
www.brandt.de



HOMAG
Automation GmbH
Ligmatech Str. 1
09638 Lichtenberg
Germany
Tel. +49 37323 16-0
Fax +49 37323 17-170
info@homag-automation.com
www.homag-automation.com