

As of now with BOOMERANG®
return systems, starting on page 18

Edge banding machines Ambition 1870 - 1880 KDF 860 edition



HOMAG Group

Success through partnership

To survive in a fiercely competitive market, a company has to have fast, flexible and efficient production.

The HOMAG Group, with its sales and service network in over 90 countries around the world, offers you and your employees a strong partnership no matter where you are.

The HOMAG Group of companies cover all areas of woodworking and wood-processing.

Panel sizing, sawing, edge technology, transportation technology and handling systems are just a few of our specialties. We also offer solutions for drilling, coating technology, surface technology, plants for doors and doorframes, timber house

construction, sanding technology, automation systems, packaging equipment and software. We provide a complete and innovative range of products and services that are always the perfect solution for any requirement.

You, our customers, benefit from high precision, performance and cutting-edge technology.



BRANDT

Perfect edges for demanding customers

We offer our customers innovative and powerful edge banding machines. Efficiency and quality have the highest priority, and ensure long-term competitive advantages for you. With an annual production of over 2000 edge banding machines, we are the edge banding specialist in the HOMAG Group and the world leader in our market segment.

A high degree of standardization in combination with an advanced manufacturing process and more than 50 years of engineering experience ensure state of the art quality at a superb price-performance ratio. Our clear and structured product range is designed to meet the demands of current and future market trends.

All of our developments are focused toward practically-oriented and economic solutions that guarantee you the best possible production results.

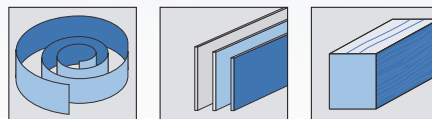

mm	Coil	Strips	Solid
a		min. 70	
b	8 - 60 (option 80)		
c	0,4 - 12 (option 20)		
d	65 (option 85)		
e	max. 30		

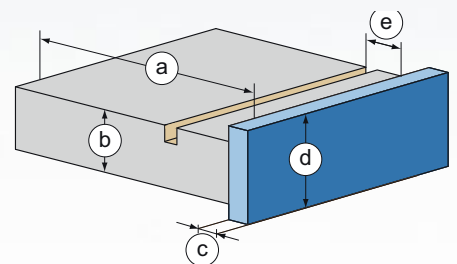

"With us, you and your products come first. A promise that you can count on!"

"Ideally prepared for your requirements"

Ambition 1870 FSC - 1880 FSCU

Uncompromising performance every time

The Ambition 1800 series offers a service portfolio that is ordinarily only seen in industrial edgebanders. The standard version is equipped with a joint trimming unit, a precision gluing unit, a tiltable end trimming unit, a top/bottom trimming unit and a four motor contour trimming unit. A perfect finish is guaranteed by the radius scraper and a buffing unit.

On-demand availability and a perfect glue line are guaranteed by the Quick-melt gluing unit which is standard on all machines in this series. Uncompromising performance is achieved via standard workpiece gap optimization, a rough trimming unit for heavy

trimming, a tiltable grooving unit and a glue joint scraper, plus variable feed speed of 8-20 m/min. The universal trimming unit guarantees an excellent and all-purpose performance of the grooving and profiling stations.



The right solution for your requirements

The Ambition 1800 series machine leaves nothing lacking. Whether your needs are "batch size one" production, for demanding bespoke shop fitting applications, living & bedroom furniture or functional office furniture, the Ambition 1800 Series always offers the right solution for your requirements.

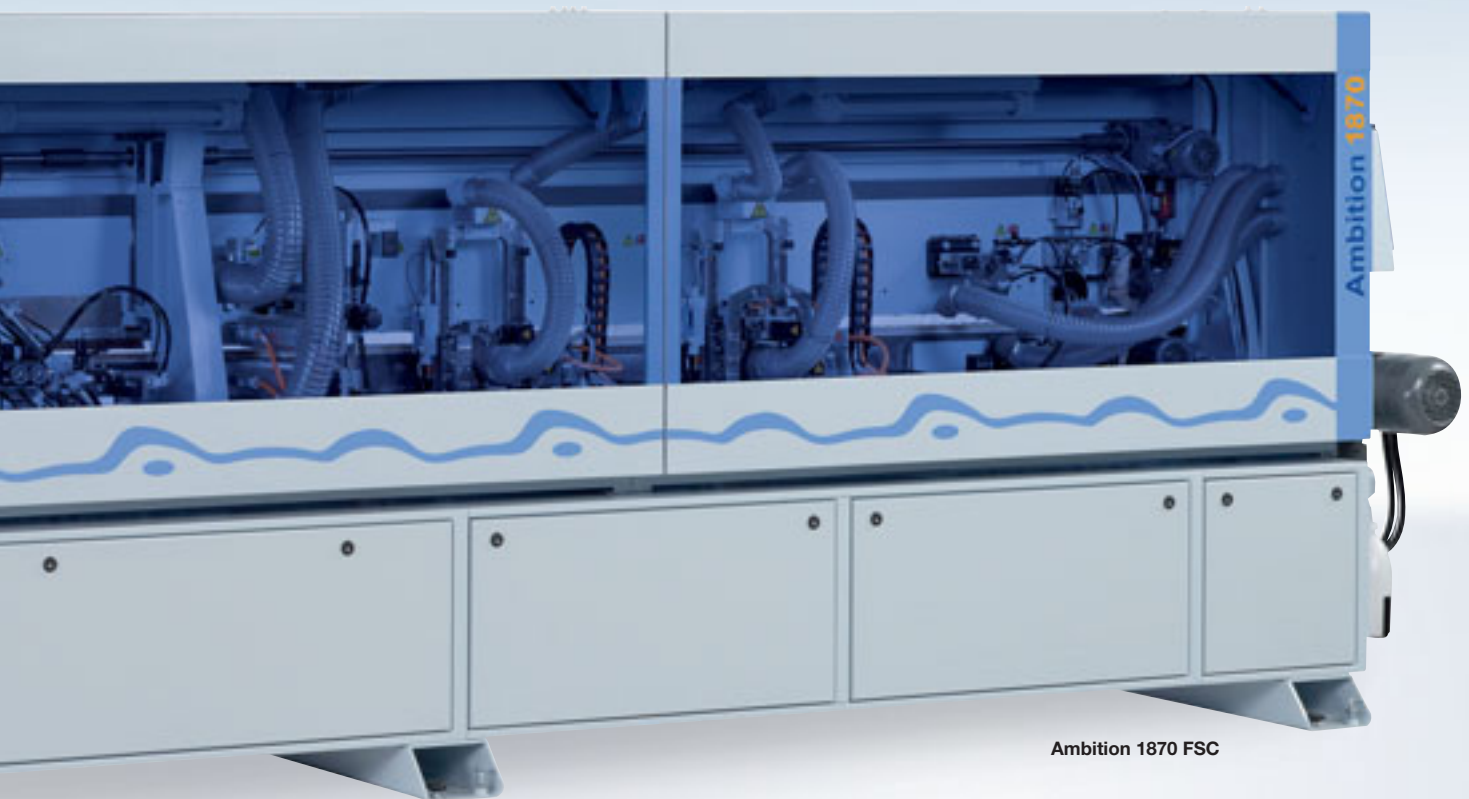

Ambition 1870 FSC



powerTouch – The new dimension in machine operation

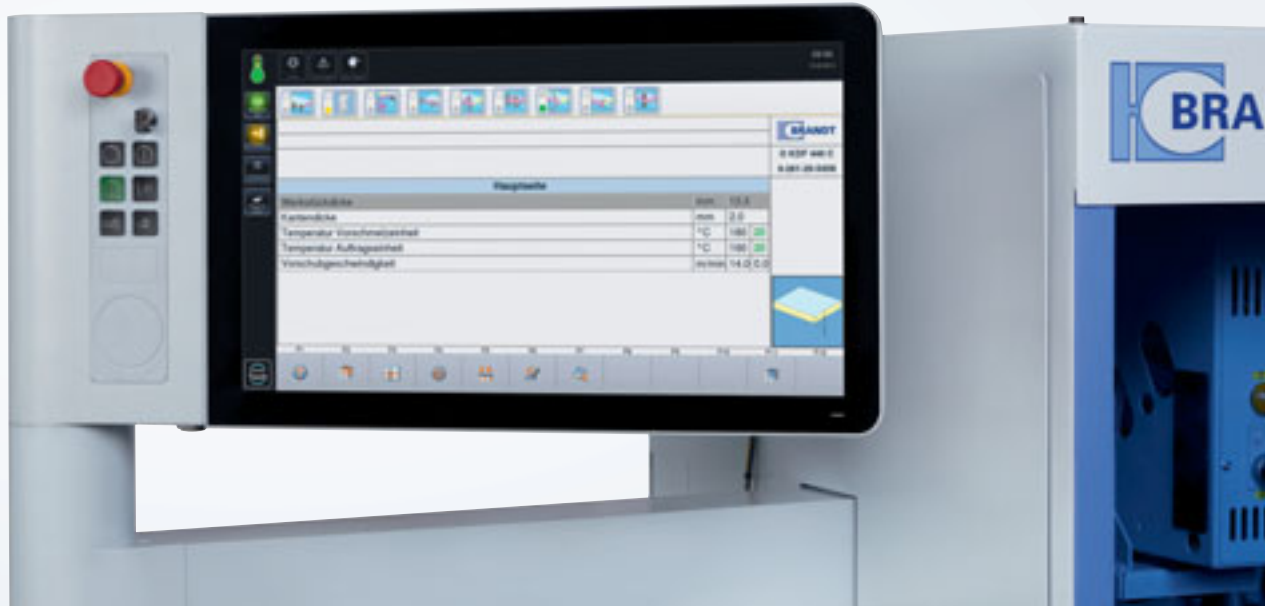

powerTouch (optional) implements the HOMAG Group's new operating philosophy: Simple, standardized, ergonomic and evolutionary. The innovative touchscreen operating concept unites design and function to create a totally new control generation."

- 21" screen with full HD resolution
- Fast overview of machine status
- Simple, user-oriented navigation

- Traffic light assistant helps guide the user towards readiness for production
- Standardized design of the user interface

- Intuitive, natural touch operation of the machine
- Use of gestures such as swiping, scrolling

At the focus of this solution is a large multi-touch monitor in widescreen format, which is used to control machine functions by direct touch contact. The entire user interface has been optimized for touch operation and offers an array of help and assistance functions designed to radically simplify the work experience. Standardized control elements and software modules ensure that all HOMAG

Group machines can be operated with the same familiar look and feel using this new concept. They differ only in terms of a few machine-specific details. This not only simplifies the operation of different machines, but also makes for great efficiency by significantly reducing time for servicing and training.



Machine data capturing for maintenance depending on need and for the representation of important operating figures (e.g. number of pieces, production time, edge material quantity)



Teleservice reduces field service work operations

- Reduction of service cost
- Avoidance of an unscheduled machine downtime
- Specific scheduling of field service work + spare parts
- Support to maintenance and operation staff

airTec - Reactivation unit

Zero joint technology for highest demands

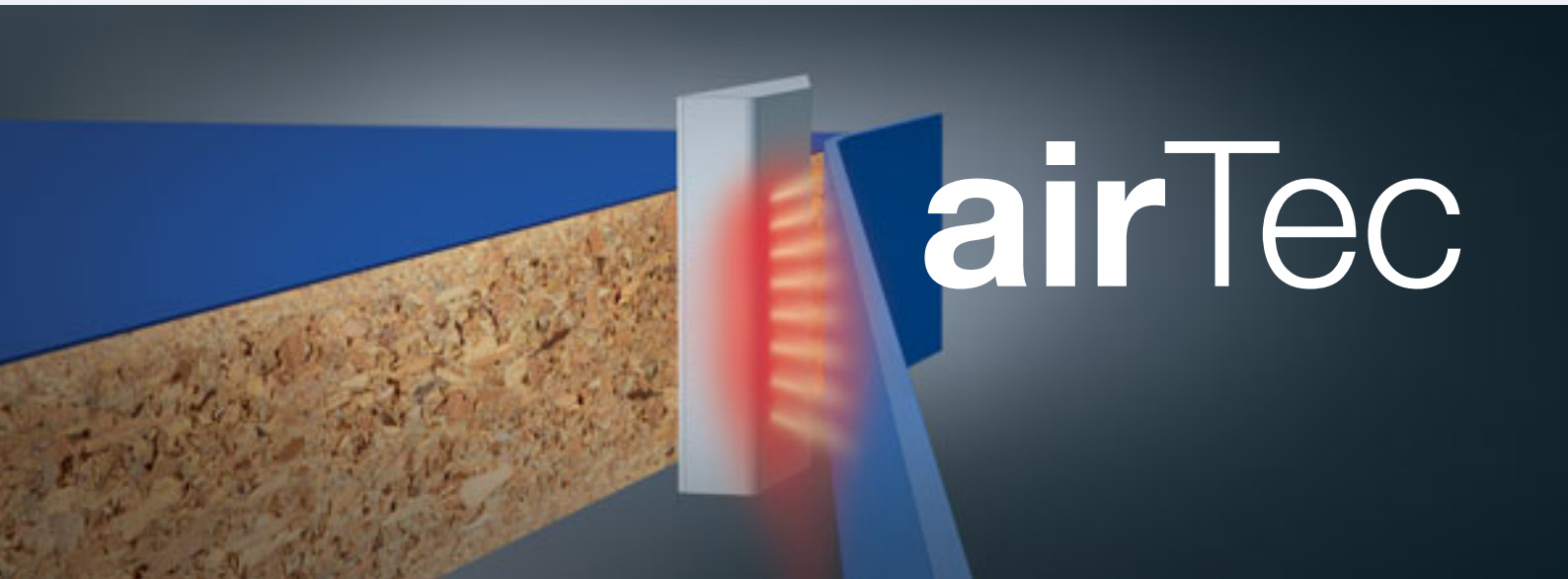

The **airTec – reactivation unit (optional)** guarantees optimal zero joints and is an industrial- and craft-oriented solution. To achieve a zero joint finish, the function layer on the edging material is reactivated by compressed hot air, providing seamless adhesion.



Unit for the activation of the functional layer on edge material, for a workpiece thickness from 8 - 40 mm. The **airTec** reactivation unit is installed in such a manner that you can work either with the standard glue application unit or with the airTec system. **airTec** can be used to process all types of currently popular, laser suitable edging types.

- Installation ex factory with complete integration into the control
- Temperature and pressure adjustable via control
- Process-specific parameters can be assigned to the corresponding programs and stored
- Indication of set and actual temperature
- The actual air consumption value depends on panel length and the gaps between the workpieces.



Spraying unit - standard

The spray unit for Antistatic solvent is included in the **airTec – reactivation unit**, to achieve a perfect finish.

Easy integration into the magazine

	Activation unit AT15	Activation unit AT20
Feed speed max.	15 m/min	20 m/min
Workpiece thickness	8 - 40 mm	
Operating pressure	4 - 6 bar	4 - 7 bar
Air consumption	250 - 1.400 N/min.	

*The following requirements must be provided by the customer:
 - Compressed air supply 8 bars - 1 inch supply line - 1500 NI/min.

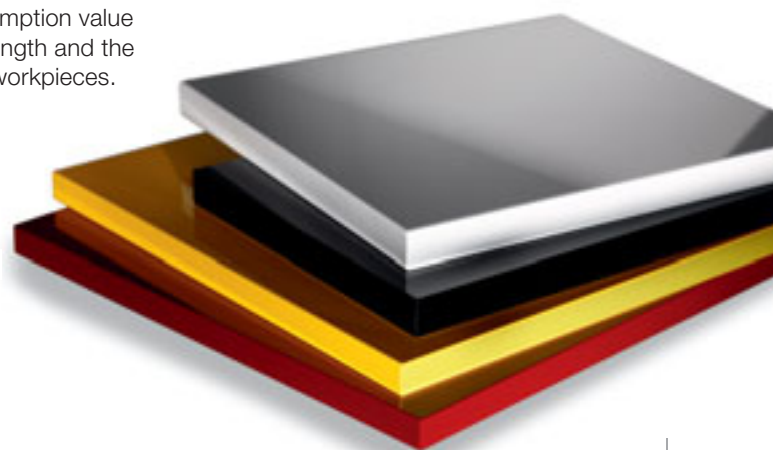

Significant competitive advantages – Pace setting performance and quality



Infeed stop

For minimum workpiece spacing and safe operation.



Joint trimming unit

Perfect cut and high operating life due to diamond tipped tools for an optimum edge joint quality.

Standard Gluing Unit

Quickly changeable application unit. Glue reservoir underneath the glue roller. Processing of granulated PU glue is possible.



Radiant heater

Strong adhesion through optimal pre heating of the workpiece.

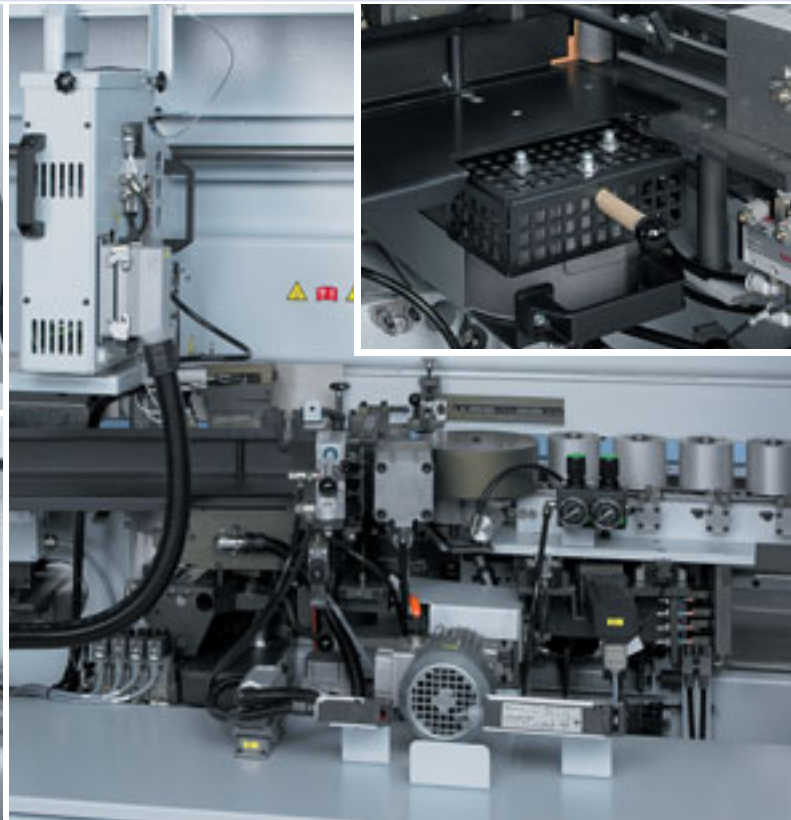

Magazine + pre-melter

Coil and automatic strip magazine with optical monitoring for reliable material supply, high availability and perfect glue quality via the Quickmelt gluing unit.



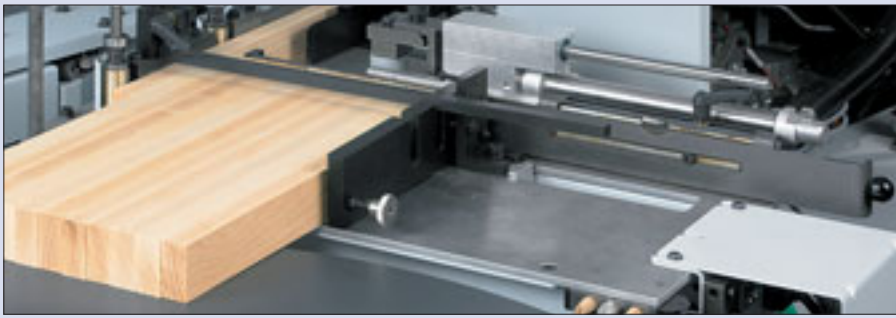

Extra wide magazine (optional)

Extra wide magazine with high capacity for fixed length strips and optimum access to reload.

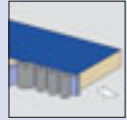

Pressure zone

Heavy pressure zone (up to 20 mm) to ensure an optimum glue joint quality.



Top pressure belt (optional)

Top pressure belt system optionally available instead of the standard top pressure roller system.

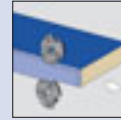

Rough trimming unit

For rough trimming of all common edge banding materials.

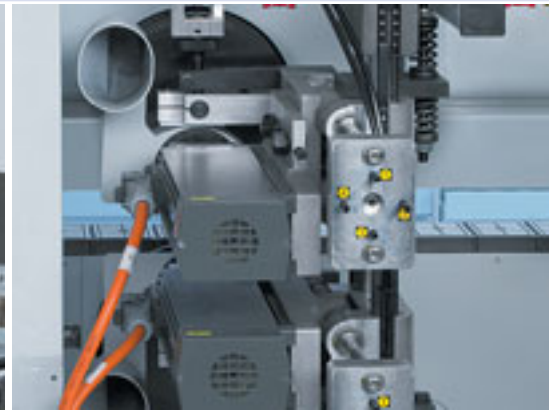

End trimming unit

Perfect cutting by the end trimming unit using rigid high-precision linear guides and the workpiece gap optimization package to achieve higher output in the same processing time. Soft-touch for optimal end trimming results even at high speeds.

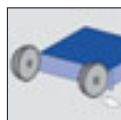

Trimming unit

Trimming unit with DFC (Dust Flow Control) tooling technology for optimal extraction. Optional pneumatic or servo axis adjustment available.

Multistage trimming unit MS 40/45 (optional)

Fully automatic adjustment between 3 different profiles by means of servo motors.

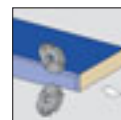

Significant competitive advantages – Pace setting performance and quality



Central lubrication unit

Fully automatic lubrication of the feed track guidance system to guarantee precision and a long-life time of the conveyor chain.

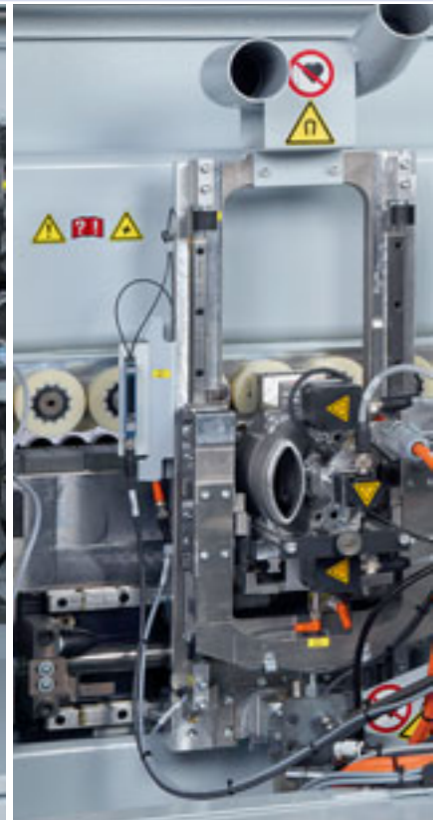
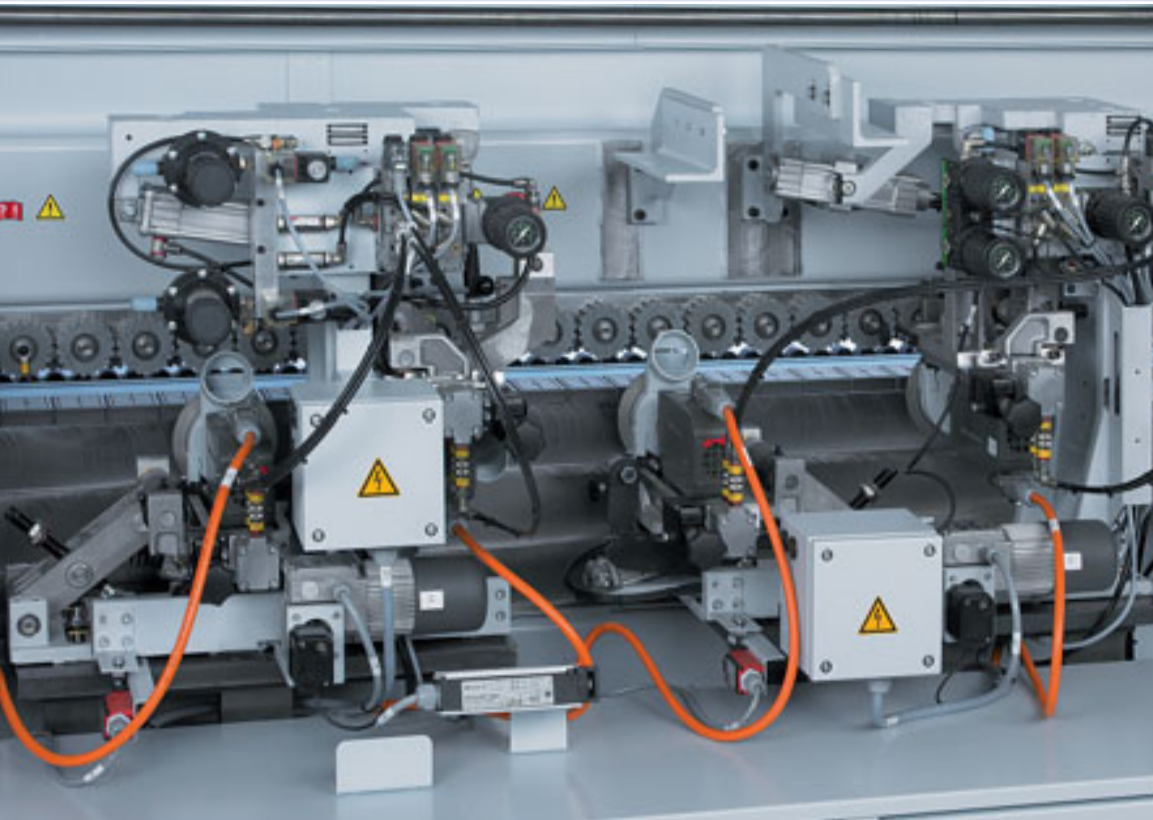

Corner rounding unit FF 12 (4 motors)

For corner rounding of thick PVC edges, as well as postforming and softforming profiles at feed speeds of up to 20 m/min. Equipped with servo motor adjustment for different edge thicknesses. Workpiece thickness up to 60 mm.





Nesting package (optional)

Includes a multi-roller tracing device for the trimming and scraping units to compensate for hinge holes.



Tiltable grooving unit

For grooving work pieces either from the bottom side or from the edge side. It is possible to do either continuous grooving or non continuous grooving, as well as jump grooving for biscuit joints.

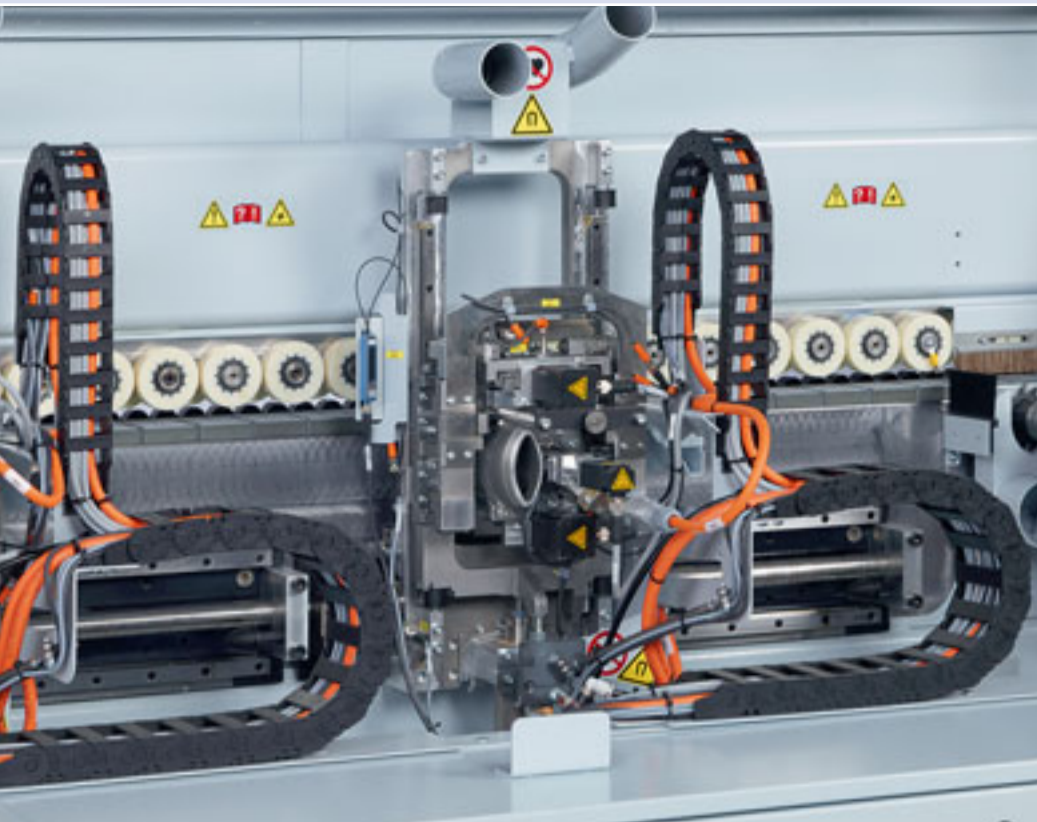

Multifunctional trimming unit MF 60 Servotrim

For processing the edging overhang at the upper and lower edge of the workpiece as well as for corner rounding of the front and rear edge. Servo-controlled movement with soft-touch function for optimal handling of e.g. high gloss surfaces or light weight panels. Workpiece thickness up to 100 mm.

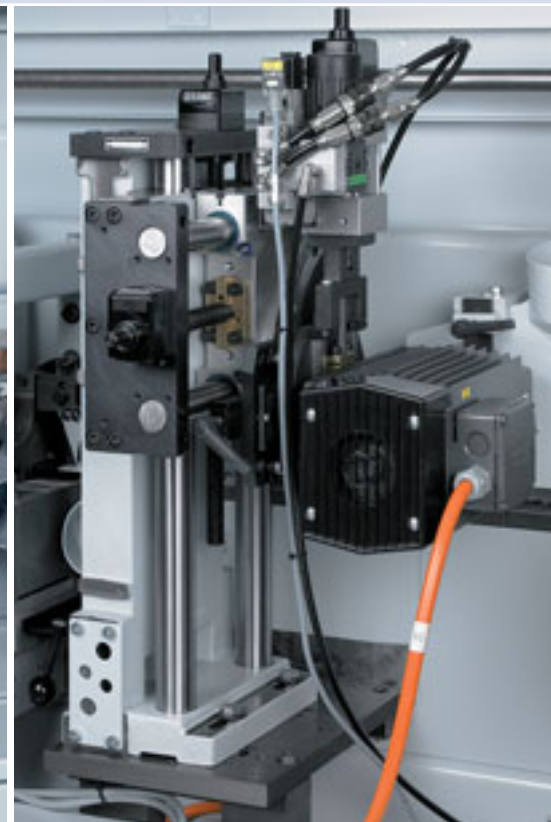

Universal trimming unit

Universal unit with high capacity for grooving and profiling work. Flexible by unlimited setting options.

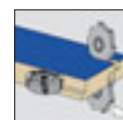

KDF 860 edition – Multistage technology as standard. Flexible reactions for high demands

The spectrum of edge and panel material is growing continuously, which means that the requirements of our customers are increasing, too. No matter what materials you use: plastic, solid wood, veneers and high gloss surfaces. The multistage trimming and scraping units always offer the ideal radius and the best results.



1. Straight 2. Profile 1 3. Profile 2

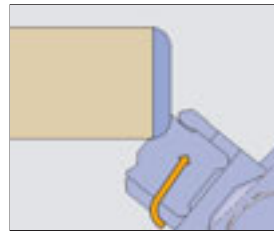

1. Profile 1

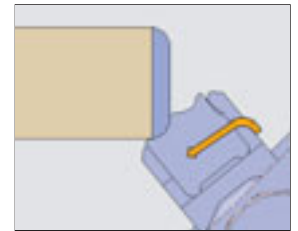

2. Profile 2

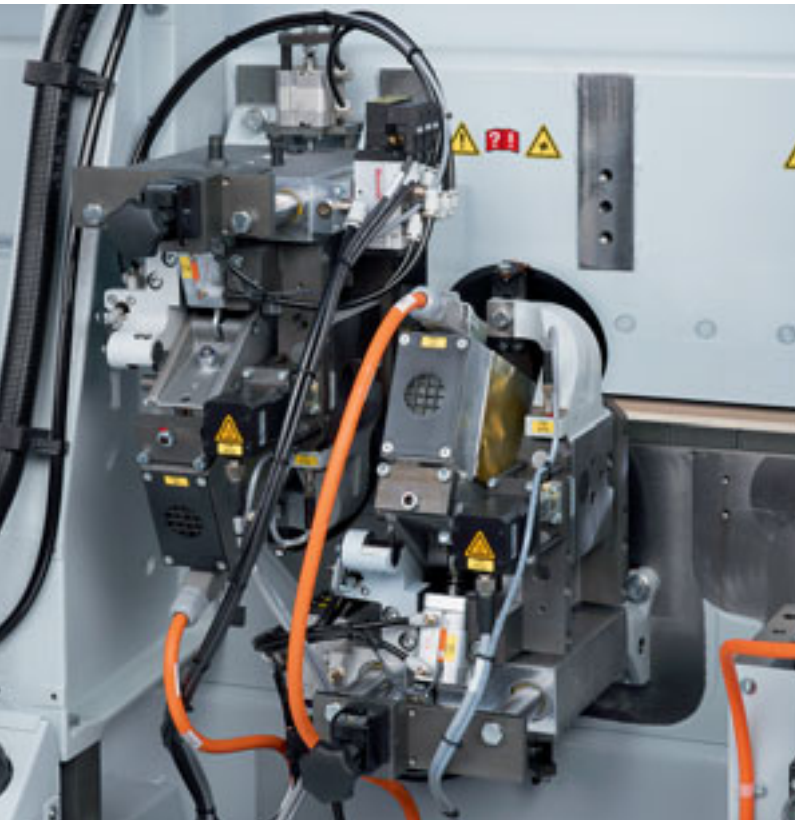

Multistage trimming unit MS 40/45 (optional)

Fully automatic adjustment between 3 different profiles by means of servo motors*.

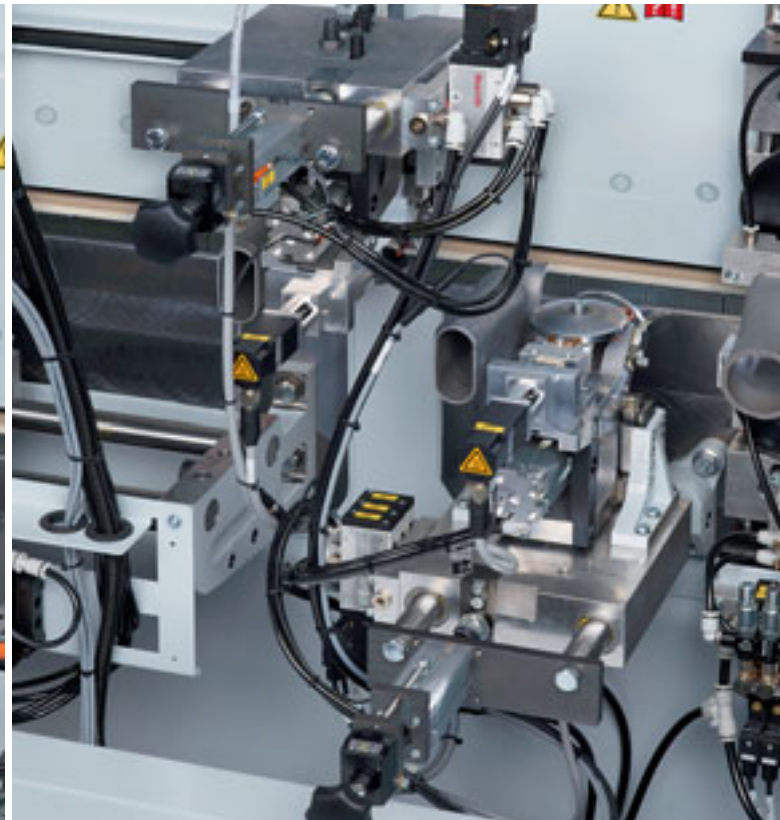
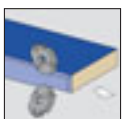

Multistage scraping unit MZ 40 (optional)

Fully automatic adjustment between 2 different profiles by means of servo motors*.

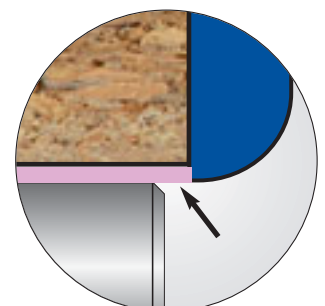
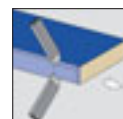

Optimal positioning for protection foil / peelcoat materials.

***Servo motors:** The servo drive consists of a motor with an infinite adjustment. The result is high performance accuracy, especially in case of short adjusting distances.



V-belt top pressure as standard

Significant competitive advantages – Pace setting performance and quality

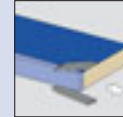

Glue joint scraping unit (optional)

For the perfect finish.

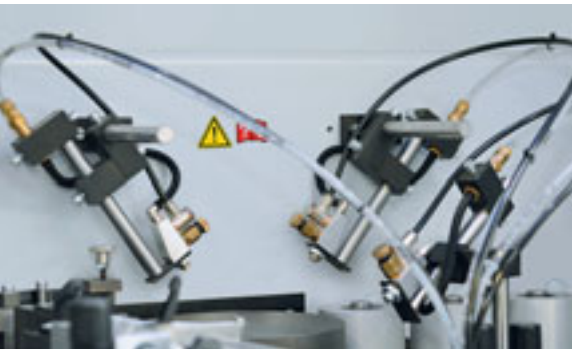

Spraying unit (optional)

Separation and cleaning devices for an optimal processing result with sensitive surfaces.

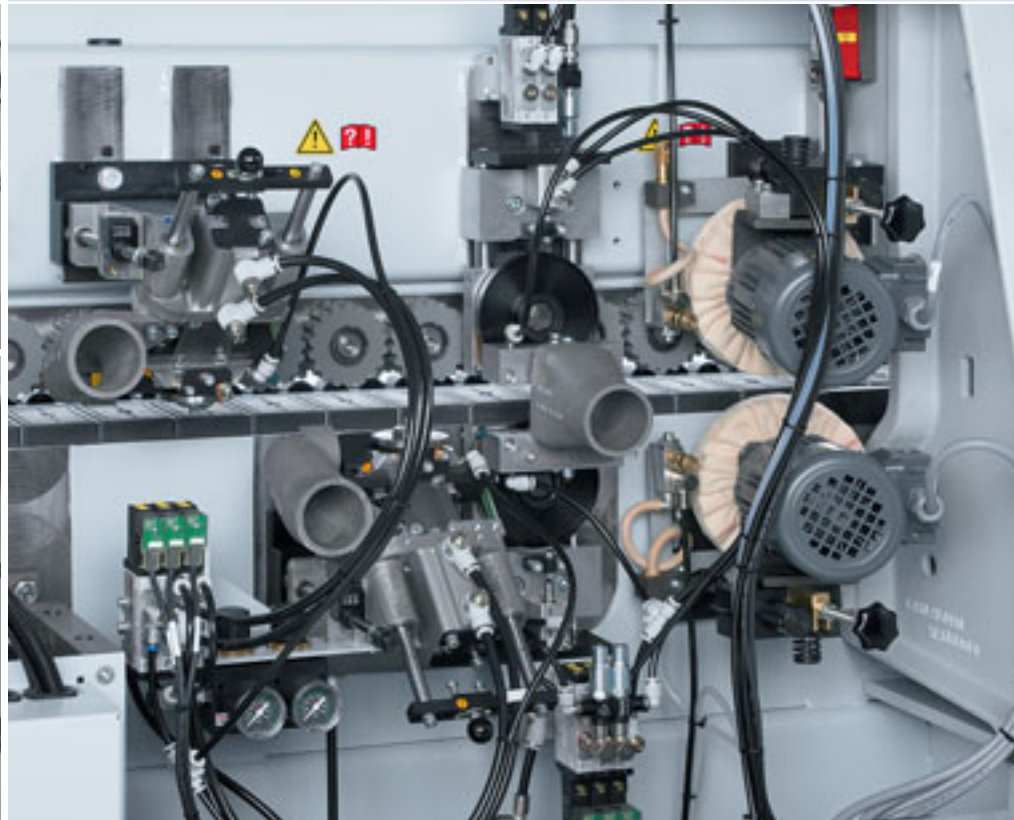

Profile scraping unit

Unit to smooth radii or chamfers, equipped with quick change heads for fast profile change.



Buffing unit

Buffing unit to polish edges and maintain their natural colour.



HOMAG Group LifeCycleService

The sale of our machines comes with all-in optimum service backup and individual advice.

We support you with service innovations and products which are optimally tailored to your requirements.

With short response times and fast customer solutions we guarantee consistently high availability and economical production - over the entire life cycle of your machine.



1200

Service employees
around the world

85,2 %

less on-site-services through
successful remote diagnosis

650

processed spare parts
orders / day

> 150000

machines, all electronically
documented in 28 languages
– in **eParts**

Remote Service

- Hotline support via remote diagnosis regarding the control, mechanics and process technology. Through this the on-site service can be reduced by 85.2 %!
- Mobile applications such as Service-Board reduce the costs through fast help in case of troubles with mobile live video diagnosis, online service message and the online spare parts shop eParts



Spare Part Service

- Identify, request and order spare parts around the clock via www.eParts.de
- Local availability of parts through sales and service companies as well as sales and service partners all over the world
- Reduction of downtimes through defined spare parts and wear parts kits



Field Service

- Increased machine availability and product quality through certified service staff.
- Regular checks through maintenance / inspection guarantee the highest quality of your products
- We offer you the highest availability of technicians in order to reduce downtimes in case of unpredictable troubles



The new gluing generation – glue application as a system

Due to today's variety of products and increasing customer's demands it has become necessary to focus on a future-oriented gluing technique. The new glue application system QA 65 N meets all market requirements and offers excellent solutions for a modern interior shop or furniture production companies.

Your benefits at a glance – Application unit QA 65 N (optional)

- Special coating of the gluing unit for all types of glue, including PUR in order to meet all customers' requirements.
- Glue application in both directions, synchronism and antirotation for a perfect adhesion of different edge materials – full reproducibility
- Simple removal of the application unit via a quick change system with a pneumatic interface
- Changes to workpiece thicknesses do not necessitate resetting of the glue application roller
- Easy-access granulate tank and level control
- Glue roller with integrated heating guarantees constant temperature for all workpiece thicknesses

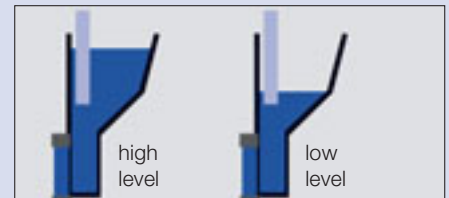

- The change over to a low glue level guarantees a fast heating-up for the processing of small batch sizes

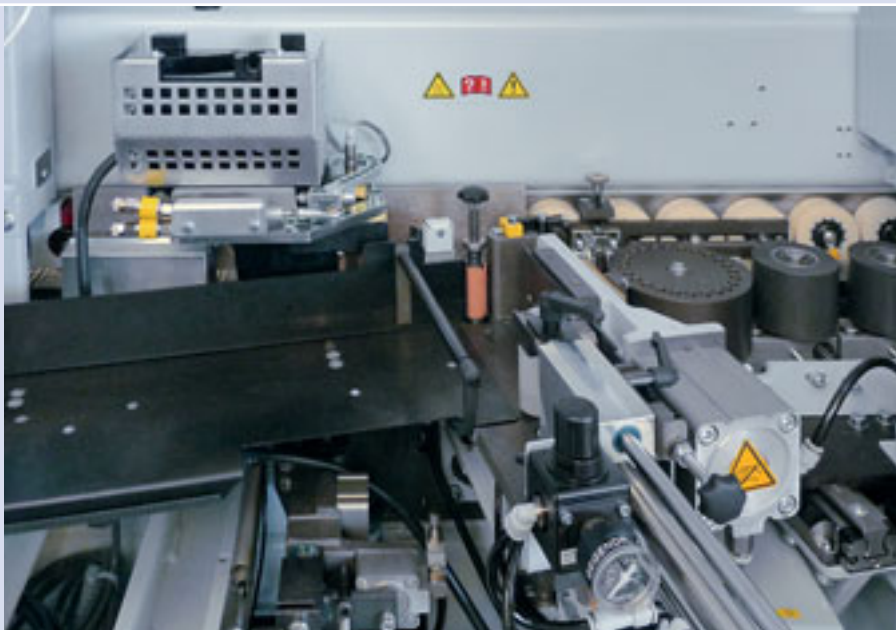

QA 65 N – Manual

- The application unit is filled by hand either with granulated glue, or with glue slugs
- Flexible application of different hot melt adhesives, like EVA, PU or Polyolefine based glue or different glue colours



QA 65 N – EVA

- EVA pre-melting unit for hot melt glues
- Filling capacity approx. 4 ltrs. granulated hot melt glue



QA 65 N – PU

- PU pre-melting unit
- Regulated melting capacity complies with adhesive consumption
- Container size: 2 kg slugs

Service station (optional)

- Holding devices for 2 application units
 - One preheating unit incl. temperature control and glue roller drive
- Easy cleaning, filling and draining of application unit

Technical data

Type of machine	KDF 860 edition	Ambition 1870 FSC
	Machine dimensions	
Machine length (mm)	6560	6760
Working height (mm)	950	
Machine dimensions WxH (mm)	1555 x 2300	
	Working dimensions	
Workpiece thickness (mm)	8 - 60 (optional 80)	
Edge material thickness (mm)	0,4 - 12	0,4 - 12 (optional 20)
	Miscellaneous	
Feed speed (m/min)	var. 8 - 20	
Weight (kg)	3000	3400
Connected value (kW)	22	23
Extraction diameter (mm)	1x120/1x180/1x100	1x120/1x160/1x100
Electrics	400 V - 3 Ph. - 50 Hz.	
Pneumatics (bar)	6	



Multistage technology as standard

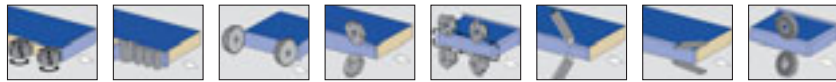

KDF 860 edition

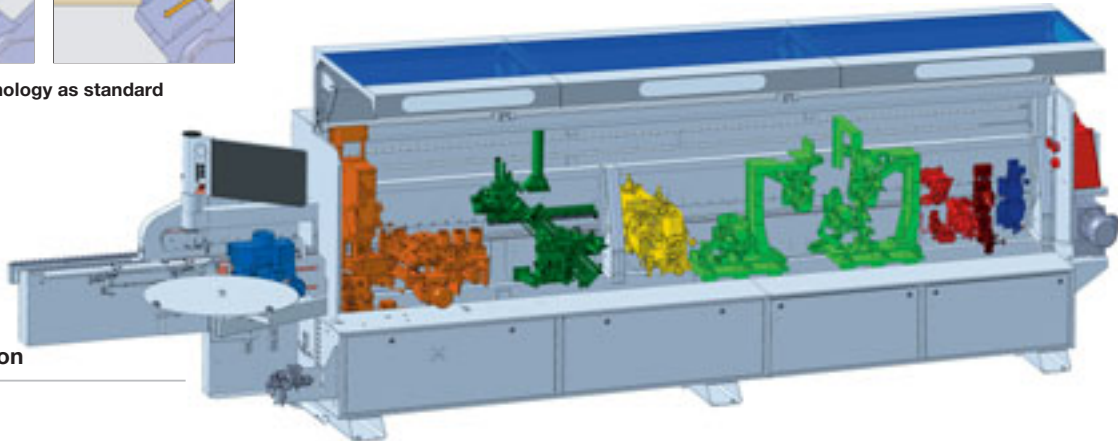

Ambition 1870 FSC

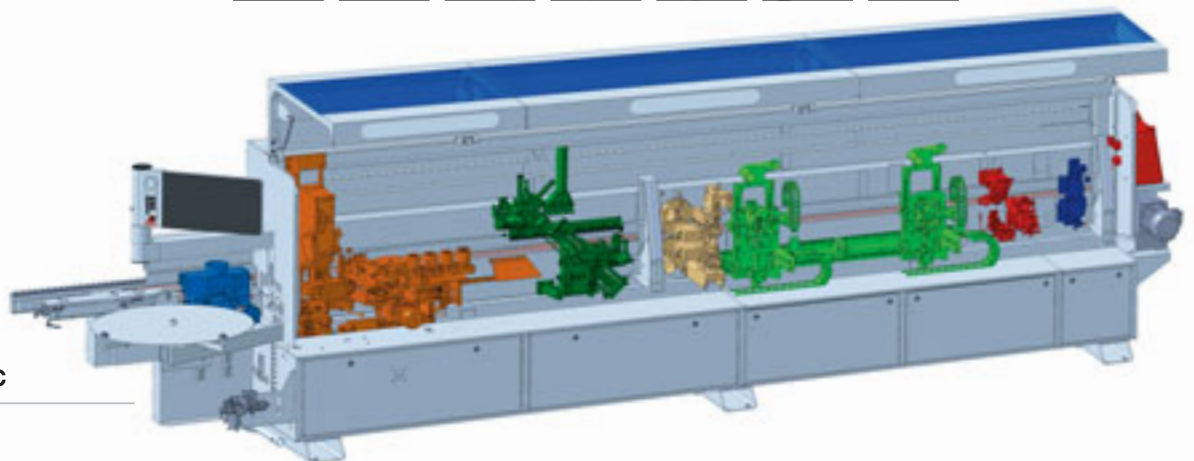



Type of machine	Ambition 1880 FGC	Ambition 1880 FSCU
	Machine dimensions	
Machine length (mm)	7760	7760
Working height (mm)	950	
Machine dimensions WxH (mm)	1555 x 2300	
	Working dimensions	
Workpiece thickness (mm)	8 - 60 (optional 80)	
Edge material thickness (mm)	0,4 - 12	0,4 - 12 (optional 20)
	Miscellaneous	
Feed speed (m/min)	var. 8 - 20	
Weight (kg)	3600	3600
Connected value (kW)	27	28
Extraction diameter (mm)	1x120/1x200/1x100	1x120/1x200/1x100
Electrics	400 V - 3 Ph. - 50 Hz.	
Pneumatics (bar)	6	

All rights for technical changes withheld. Individual machine pictures may show options.

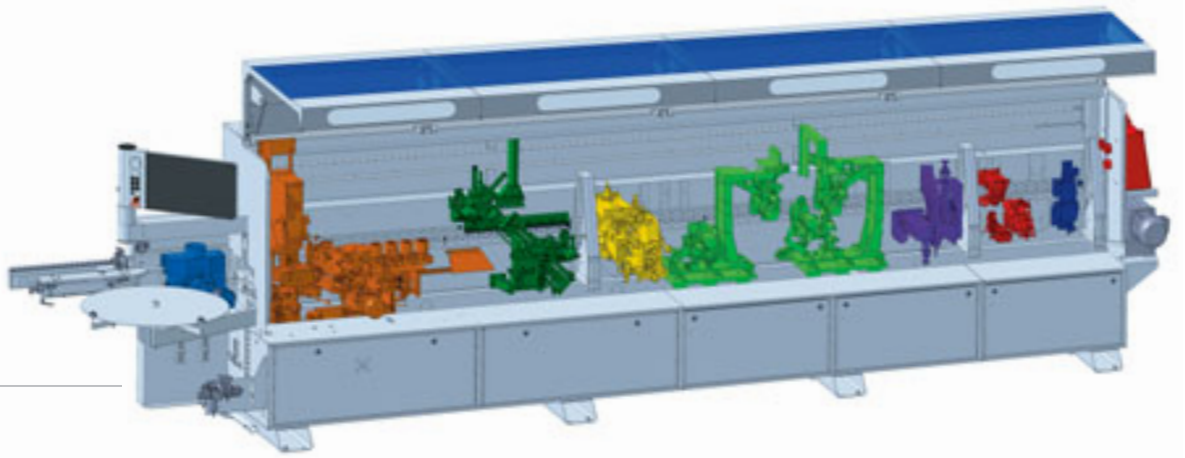
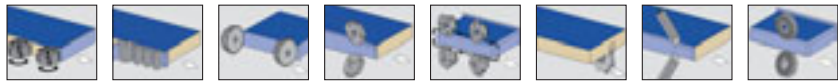

Ambition 1880 FGC

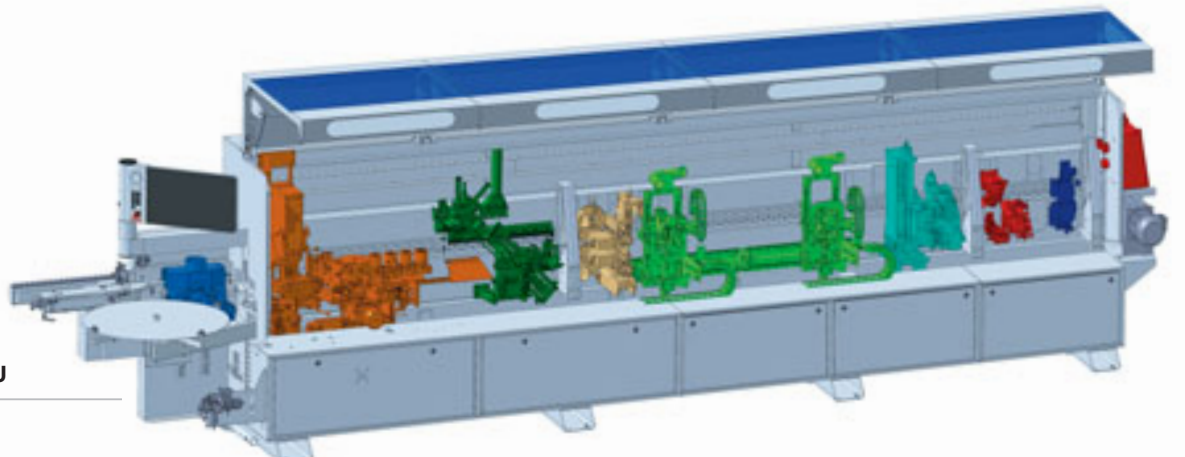

Ambition 1880 FSCU

BOOMERANG® return systems TFU 120 and TFU 140/20: Higher productivity for your BRANDT Edge Bander

As an indispensable assistant the return system renders your BRANDT Ambition even more economic. With the one-man-operation you optimize the workpiece return and allow a lean and efficient production process. Depending on the requirements you can combine your BRANDT machine of the Ambition 1600 series with a TFU 120 or TFU 140/20 model.



BOOMERANG® TFU 120

The entry to a comfortable material flow.

By the way:
The BOOMERANG® already pays off within one year, in fact starting from an operation of 9 hours per week!

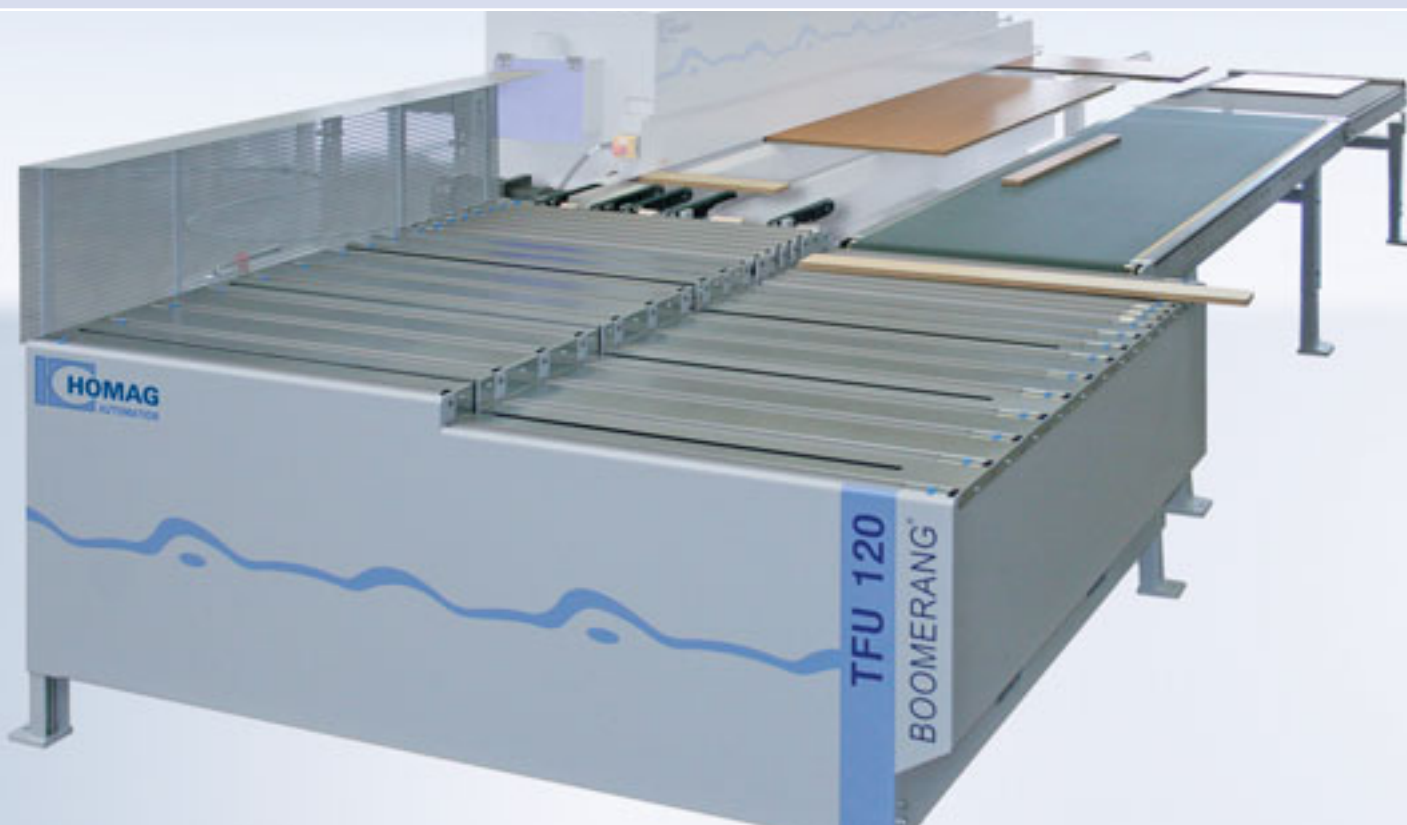

Excellently suited for customers with small, narrow, and medium-sized workpieces

The advantages at a glance:

- Fast amortization - pays off from 9 hours working time per week
- No training necessary - assemble the BOOMERANG®, connect it, and get started
- Flexible operator organization - thanks to economic one-man operation
- Ergonomic operation - operator will be released from heavy physical work
- Better quality control - fast reaction to material adjustments

	TFU 120
Workpiece length	300 - 2500 mm
Workpiece width	50 - 1450 mm
Workpiece thickness	8 - 60 mm
4-sided processing*	
min. workpiece dimension	300 x 300 mm
max. workpiece dimension	1450 x 1450 mm
Weight	max. 50 kg
Feed speed	8 - 25 m/min

*Larger workpieces can be returned or fed out for 4-sided processing with manual assistance for the transverse offset and turning.



Belt cleaning

For optimal protection against dust and chips.



CE Package

Safety engineering equipment for the protection of the employees.



Sensor-controlled pivot pins (option, TFU 120)

For easier rotation of short and narrow workpieces.



Air cushion table with stroke (option, TFU 140/20)

At the outfeed of the return system for ergonomic workpiece handling.



BOOMERANG® TFU 140/20

For a wide spectrum in the material flow.

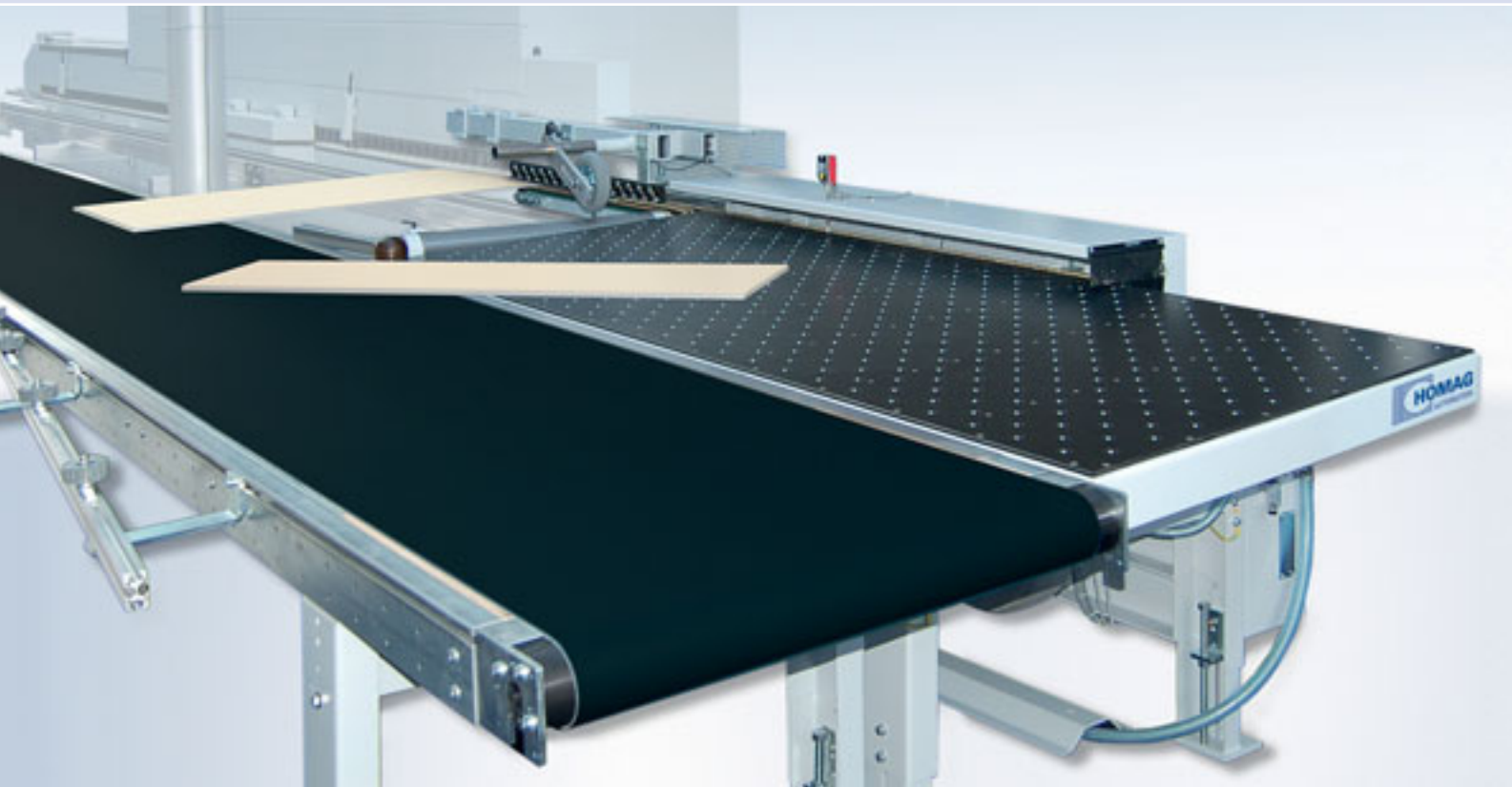

	TFU 140/20
Workpiece length	300 - 2500 mm
Workpiece width	60 - 800 mm
Workpiece thickness	8 - 60 mm
4-sided processing*	
min. workpiece dimension	300 x 300 mm
max. workpiece dimension	2000 x 800 mm
Weight	max. 50 kg
Feed speed	8 - 30 m/min

*Larger workpieces can be returned or fed out for 4-sided processing with manual assistance for the transverse offset and turning.

Best suited for customers with high material variety - from small and light up to large and heavy workpieces

The advantages at a glance:

- Fast amortization - pays off from 15 hours working time per week
- Low quality costs - gentle workpiece handling with air cushion table
- No training necessary - assemble the BOOMERANG®, connect it, and get started
- Flexible operator organization - thanks to economic one-man operation
- Ergonomic operation - operator will be released from heavy physical work



A member of the Homag Group of Companies



BRANDT
Kantentechnik GmbH

Weststraße 2
32657 Lemgo
Germany
Tel. +49 5261 974-0
Fax +49 5261 6486
info@brandt.de
www.brandt.de



LIGMATECH
Automationssysteme GmbH

Ligmatech Str. 1
09638 Lichtenberg
Germany
Tel. +49 37323 16-0
Fax +49 37323 17-170
info@ligmatech.de
www.ligmatech.com