

DIEFFENBACHER
L Ö R Z
Z A I S E N H A U S E N

KEILZINKENANLAGEN

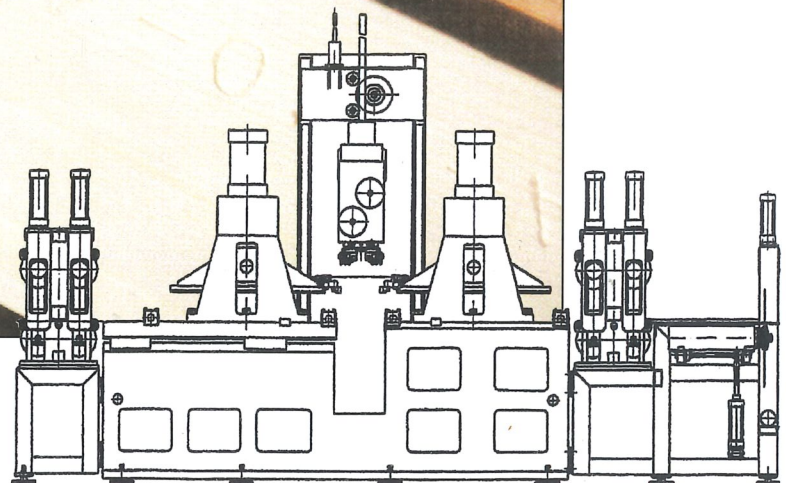
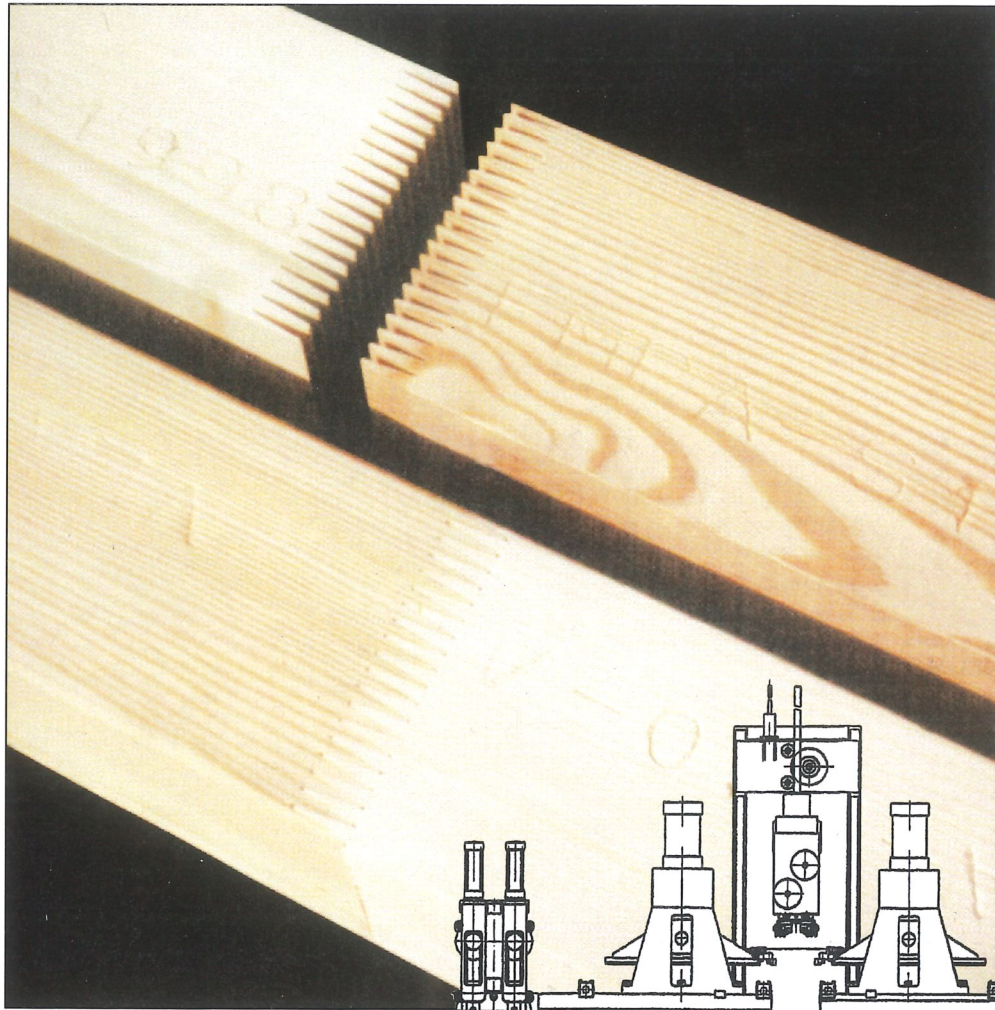

COMPACT GIGANT

COMPACT GIGANT

KEILZINKENANLAGE • FINGER JOINTING LINE • CHAINE D'ABOUTAGE
IMPIANTI DI GIUNZIONE • INSTALACION DE ENSAMBLAR MADERA

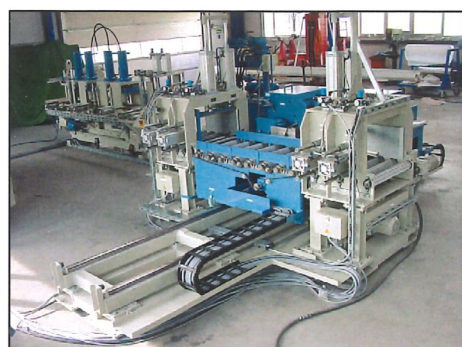
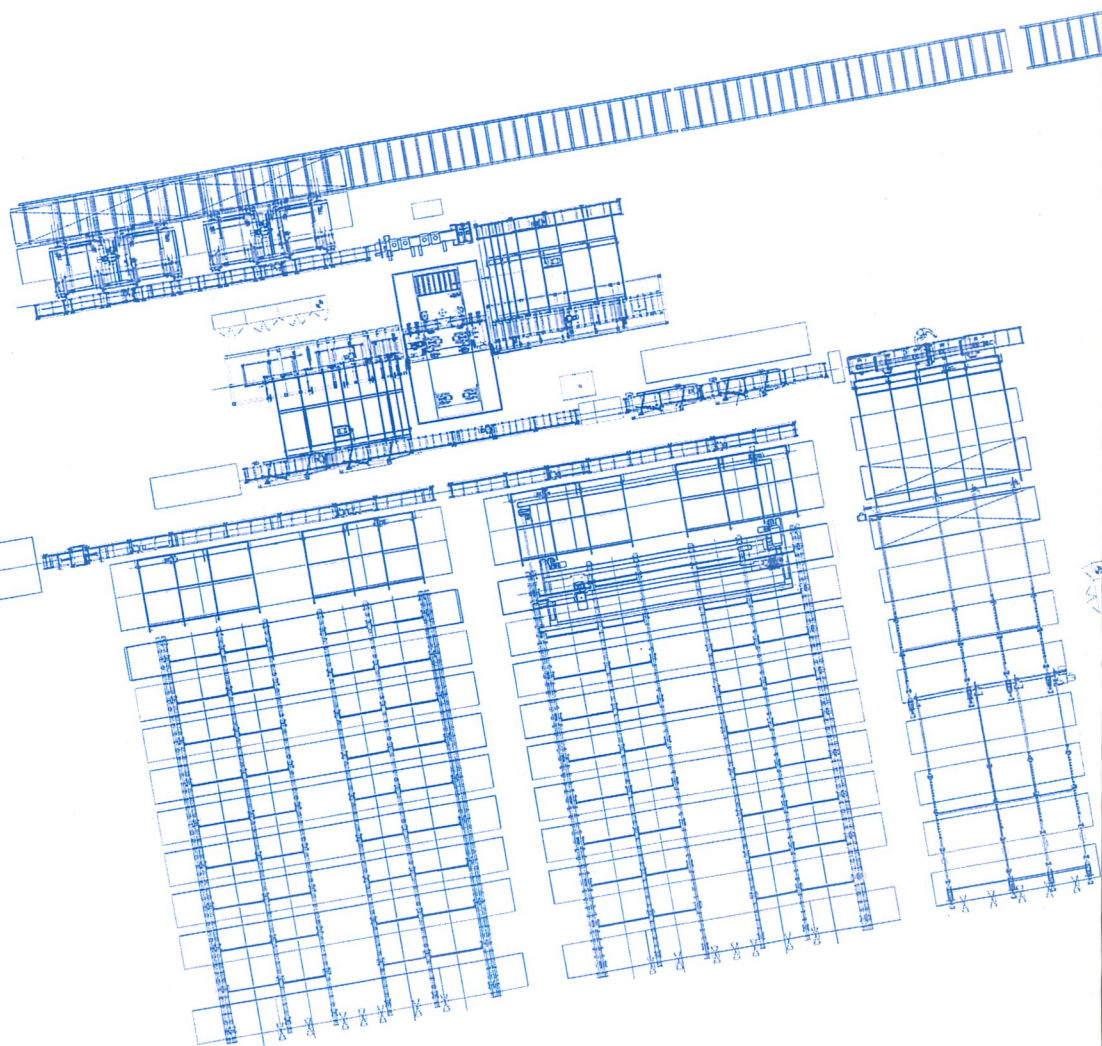

DIEFFENBACHER

L Ö R Z
Z A I S E N H A U S E N

Wartung und Diagnose

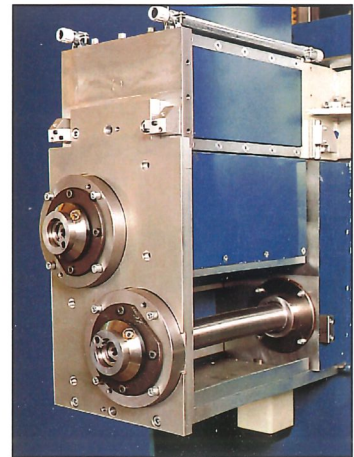
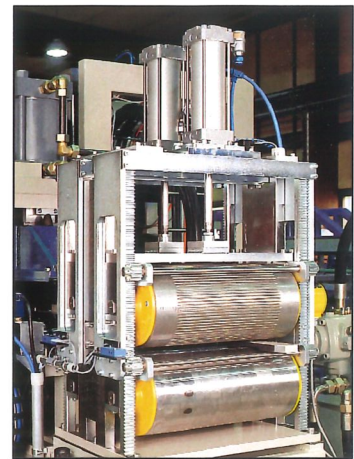
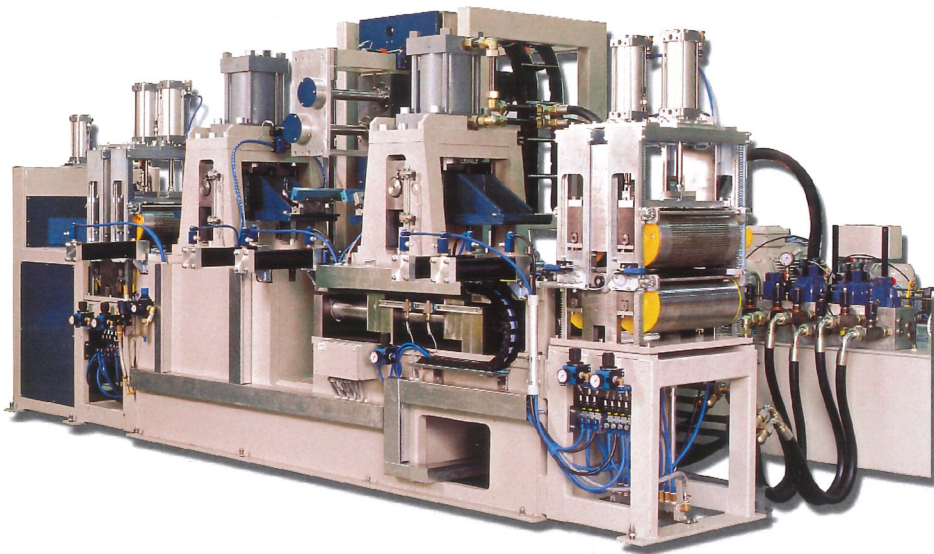
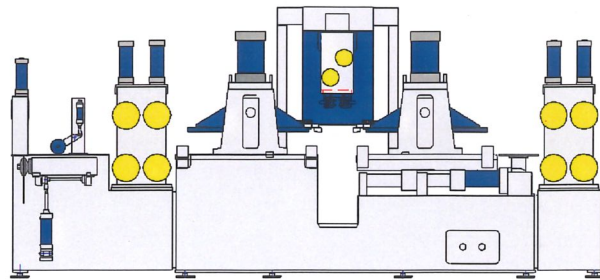

COMPACT GIGANT

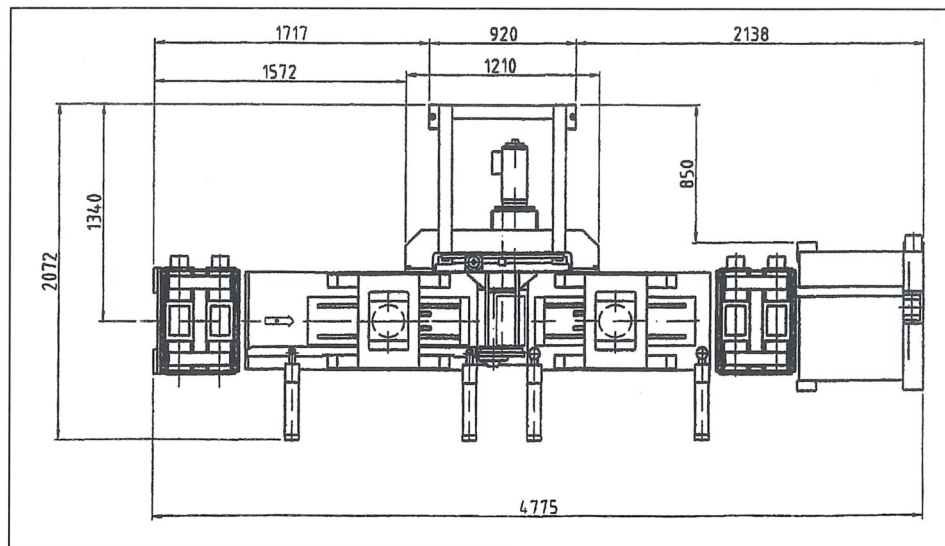

Technische Daten

Holzdaten:	Dicke:	20 - 160 mm
	Breite:	70 - 300 mm
	min. Holzlänge:	600 mm
	max. Holzlänge:	6000 mm
	max. Querschnitt:	160 x 300 mm
	min. Querschnitt:	20 x 70 mm

Presskraft: max. 30 t

DIEFFENBACHER
L Ö R Z
Z A I S E N H A U S E N

Gewerbestraße 29
D-75059 Zaisenhausen
Telefon 0 72 58-609-70
Telefax 0 72 58-609-71
www.dieffenbacher-zaisenhausen.de
E-Mail: DL.Keilzinken@t-online.de