



Optimat HPP 82
Plattenschneider
Panel Cutter
Scie à panneaux

Splitterfreier Fertigschnitt –
hochpräzise, vielseitig,
wirtschaftlich

Chipfree, finished cut –
accurate, versatile,
economical

Coupe finie sans éclats –
de haute précision,
équipement universel,
économique

Plattenschneider Optimat HPP 82 – die Faszination im Plattenzuschnitt.



Panel Cutter
Optimat HPP 82 –
Fascination in
panel cutting.

Scie à panneaux
Optimat HPP 82 –
La fascination dans le
débit de panneaux.

Für Sie als Anwender!

Ob Sie im Innenausbau, im Messe- oder Ladenbau tätig sind – ob Sie Einzelplatten oder Pakete schneiden. Gehen Sie beim Plattenschneiden keine Kompromisse ein – entscheiden Sie sich gleich für den HOLZMA-Optimat!

Alle Materialien.

Der Optimat HPP 82 schneidet mühelos sämtliche Plattenmaterialien:

- Spanplatten, roh und beschichtet
- MDF- und HDF-Platten
- Massivholz
- Schichtstoffe
- Gips- und zementgebundene Platten
- Acrylglas und Kunststoffe

For panel saw users!

No matter if you are a cabinet maker, shopfitter or doing architectural fabrication – if you cut single sheets or books of panels: HOLZMA is the most efficient solution for you, in any case. No compromises in panel cutting – decide now for the best, the HOLZMA Optimat.

All materials.

The Optimat HPP 82 cuts all panel materials:

- particle boards, raw and laminated
- MDF and HDF boards
- solid wood
- high pressure laminates
- gypsum and cement based boards
- acrylic and plastic sheets

Pour vous – Utilisateur!

Que vous soyez agenciers de salons ou de magasins – que votre débit soit des panneaux unitaires ou en paquets: avec HOLZMA vous êtes gagnant. Ne faites pas de compromis sur la découpe de panneaux – décidez-vous tout de suite pour une Optimat de HOLZMA.

Pour toutes les matières.

L'Optimat HPP 82 découpe sans peine les matériaux suivant:

- Panneaux de particules, brut ou revêtus
- Panneaux MDF et HDF
- Bois massif
- Stratifiés
- Panneaux composites, plâtre, ciment
- Plexiglas et matières plastiques

Optimat HPP 82/43

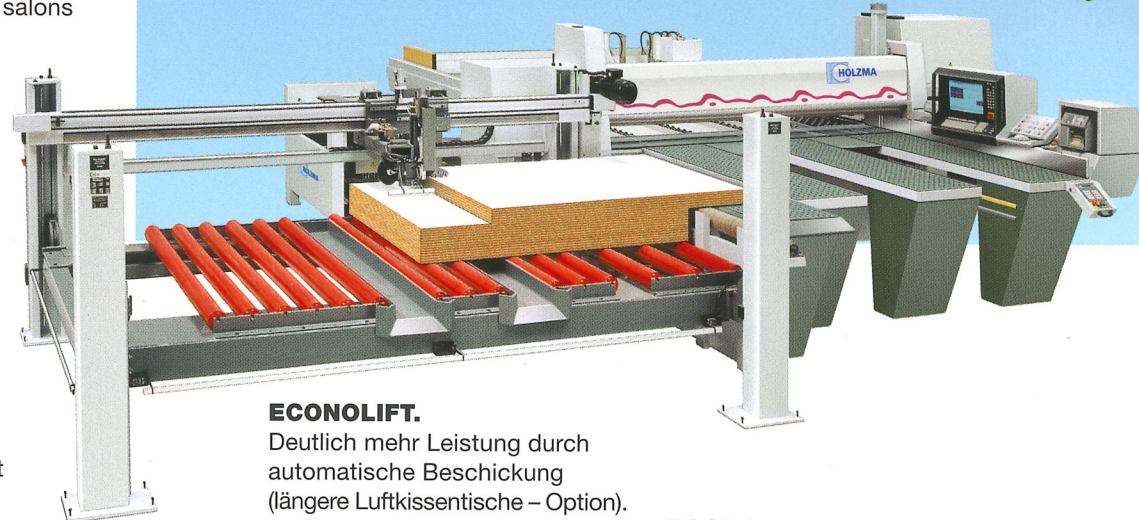
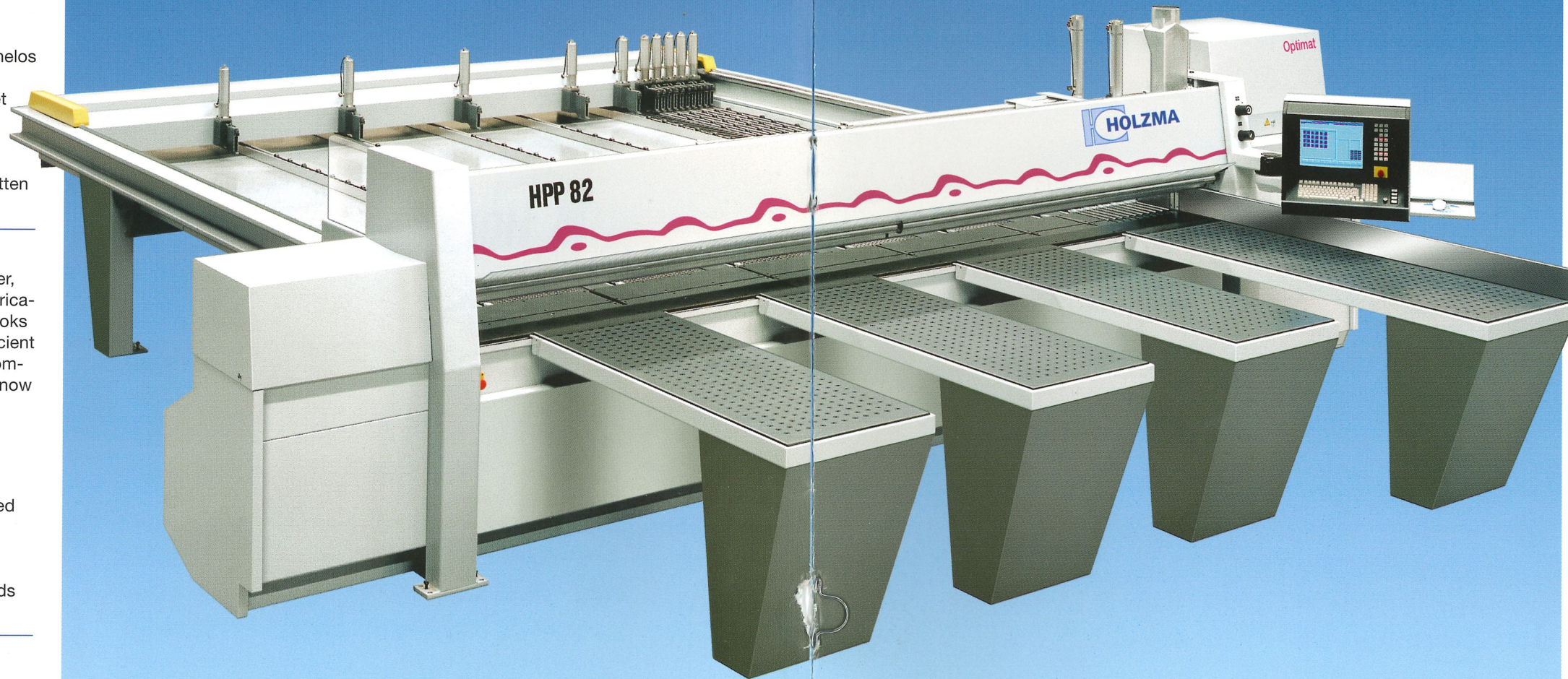

ECONOLIFT.

Deutlich mehr Leistung durch automatische Beschickung (längere Luftkissentische – Option).

ECONO-LIFT.

Considerably increased performance by automatic infeed (longer air tables – optional).

ECONOLIFT.

Augmentation significative du rendement par chargement automatique (tables à coussin d'air allongées – en option).

Qualität ist unsere Philosophie seit mehr als 30 Jahren! Eine sichere Investition: Ihr Plattenschneider vom Marktführer.

Mehr Sicherheit – mehr Platz!

Bei uns kommt die Maschine nicht „hinter Gitter“. Auch der hintere Maschinenbereich ist frei zugänglich und übersichtlich – mit zusätzlichem Stauraum unter der Maschine.

Automatisch gut!

Automatische Schnittlänge eliminiert Totzeiten • Automatische Schnitthöhe garantiert optimale Schnittqualität • Automatische doppelseitige Winkelandrückvorrichtung sorgt für exakte rechteckige Schnitte.

Quality – our philosophy for more than 30 years! A safe investment: your panel cutter from the market leader.

Safe operation and more space!

Our machine is not set “behind bars”. Free access also to the rear machine area and an excellent view on it. Additional space is available underneath the machine.

Automatically good!

Automatic cutting length eliminates downtimes • Automatic cutting height guarantees optimum cutting quality • Automatic side pressure device results in accurate, square cuts.

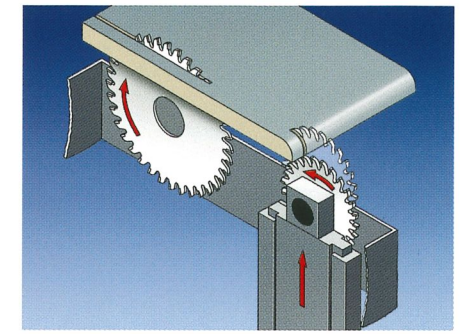

Postformingsäge (Option) • Post-forming saw (optional) • Inciseur pour les pièces postformées (en option).

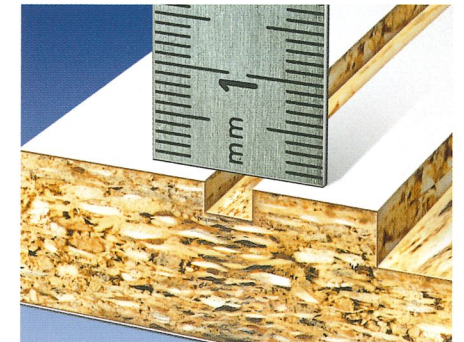

Nut und Falz • Grooving and rebating • Rainurage et feuilurage.

Digitaler Gehrungsanschlag (Option) • Digital mitre fence (optional) • Règle d'angle digital (en option).

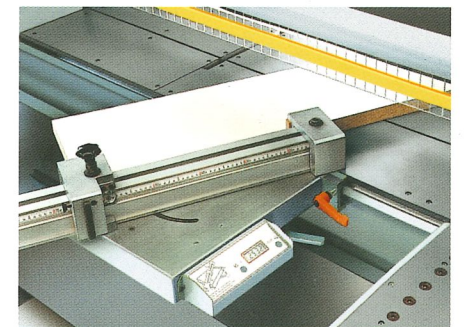

Depuis plus de 30 ans, notre philosophie repose sur la qualité! Un investissement sûr dans une scie à panneaux chez le leader du marché.

Plus de sécurité – plus d'espace!

Chez HOLZMA, la machine n'est pas mise sous «protection grillagée». L'arrière de la machine est également librement accessible et laisse un champ de vision en même temps qu'une possibilité de stockage supplémentaire sous la machine.

Automatiquement bon!

La longueur de coupe automatique élimine les temps morts • La hauteur de coupe automatique garantit une qualité de coupe optimale • Le dispositif d'équerage automatique, travaillant des deux côtés, veille à la perfection de l'equerrage.

High-Tech in kompakter Form.



High Tech in compact size.

High Tech sous une forme compacte.

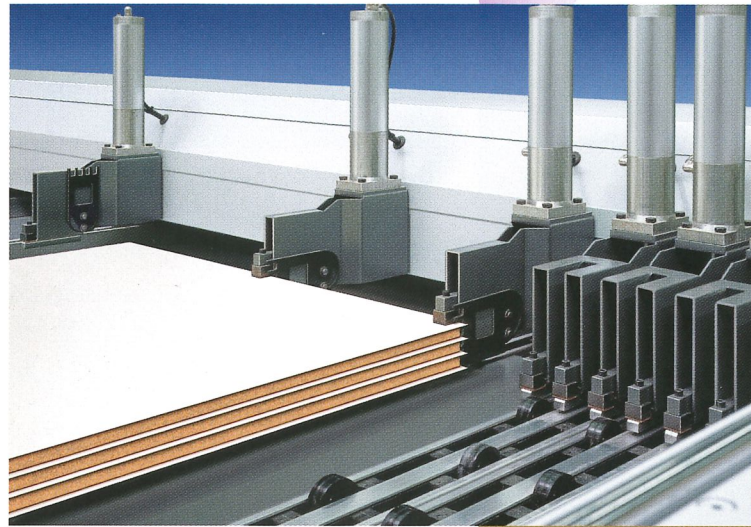

Überstehendes Laminat mit Besäumrechen.

Doppelfingrige Spannzangen im Querschnittbereich.

Projecting laminate with trimming rake.

Two-finger clamps in the crosscut area.

Placage ou stratifié débortant contre un peigne-butée.

Pinces de serrage à deux doigts au niveau de la coupe transversale.



Doppelseitige Winkelandrückvorrichtung für den Querschnitt.

Double-sided side pressure device for crosscutting.

Dispositif d'équerrage travaillant de deux cotés pour la coupe transversale.



Programmschieberführung mit berührungslosem Mess-System.

Program fence guide with non-contact measuring system.

Guidage du poussoir programmé avec système de mesure sans contact.

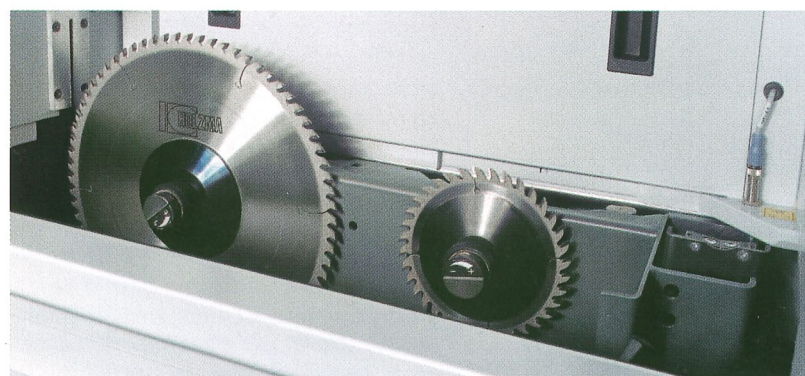

Sägewagen mit Schnellspannsystem „Power-Loc“.

Saw carriage with quick saw changing system "Power-Loc".

Chariot porte scies avec unité de serrage rapide «Power-Loc».

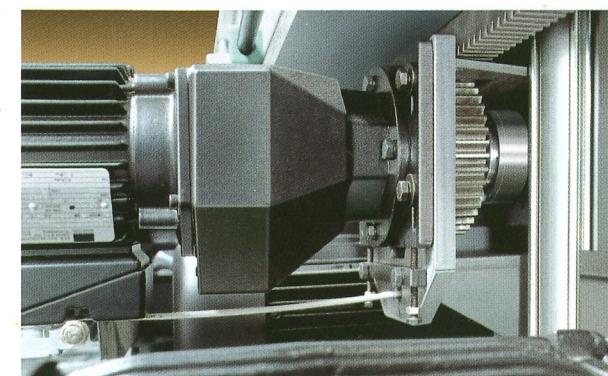

Dynamischer Zahnstangenantrieb für Sägewagen.

Dynamic rack and pinion drive for saw carriage.

Entraînement dynamique par crémaillère pour le chariot porte scies.

PC-Steuerung im Daten- verbund vom Zuschnitt bis zur Endmontage.

Optimat HPP 82- CADmatic-Steuerung.

Einfache grafische Eingabe der Schnittbilder. Grafische Anzeige der Schnittfolge. Fehlerdiagnose mit realistischen Bildern und Trouble-Shooting.

Datenverbund Online.

Die perfekte Verbindung mit dem HOLZMA-Zuschnitt-Optimierungsprogramm „Schnitt-Profi(t)“. CADplan, die Zuschnitt-Optimierung als Option an der Maschine.

PC-control for data linkage from cutting to final assembly.



Optimat HPP 82 - CADmatic-control.

Simple, graphical input of cutting patterns. Graphical display of cutting sequence. Error diagnosis with realistic photographs and trouble-shooting.

Commande par ordinateur avec liaison depuis le débit jusqu'au montage final.

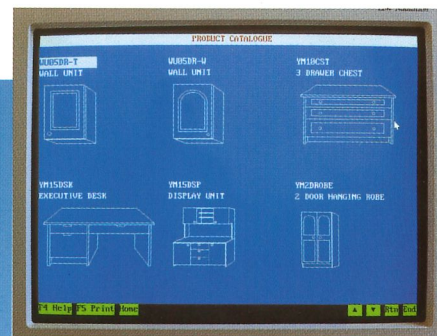

Optimat HPP 82 - Contrôle CADmatic.

La saisie des plans de coupes est simple par une présentation sous la forme graphique. L'écran graphique visualise les séquences de coupes. Diagnostic d'erreurs avec des photos réelles.

Online data linkage.

The perfect link to the HOLZMA cut-to-size optimization program "Cut Rite". CADplan, cut-to-size optimization at the machine (optional).

Liaison Online.

Liaison parfaite avec le programme d'optimisation HOLZMA «Profi(t) Coupe». CADplan - le programme d'optimisation pour le débit à la machine (en option).

Technische Daten Technical Data Données techniques	Optimat HPP 82
Sägeblattüberstand Saw blade projection Dépassement lame de scie	95 mm
Schnittlänge/-breite Cutting length/width Longeur/largeur de coupe	3100/3800/4300 mm
Hauptsägemotor Main saw motor Moteur scie principale	13,5 kW/18,0 HP Option: 50 Hz 18 kW/25 HP 60 Hz 21 kW/29 HP
Vorritzsägemotor Scoring saw motor Moteur scie inciseur	2,2 kW/3,0 HP
V = Sägewagen V = Speed of saw carriage V = Charlot porte de scies	5-125 m/min
V = Programmschieber V = Speed of program fence V = Pousseur programmé	80 m/min
Gesamtluftbedarf bei 6 bar Total air requirement for 6 bar Rendem. total de l'air avec 6 bar	20-30 l/min
Erforderlicher Luftdruck Required air pressure Pression de l'air comprimé	6 bar
Gesamter elektr. Anschlusswert Total electrical load Raccordement électrique total	20 kW/27 HP (27,5 kW/37 HP)
Absaugung Extraction Aspiration	4500 m³/h - 26 m/sec



HPP 82	A	B	C
3100 *	5100	3436	6520
3800 *	5860	4196	7120
4300 ▲	6300	4636	7670
* 3 Luftkissentische 3 Air tables 3 Tables à coussins d'air		▲ 4 Luftkissentische 4 Air tables 4 Tables à coussins d'air	

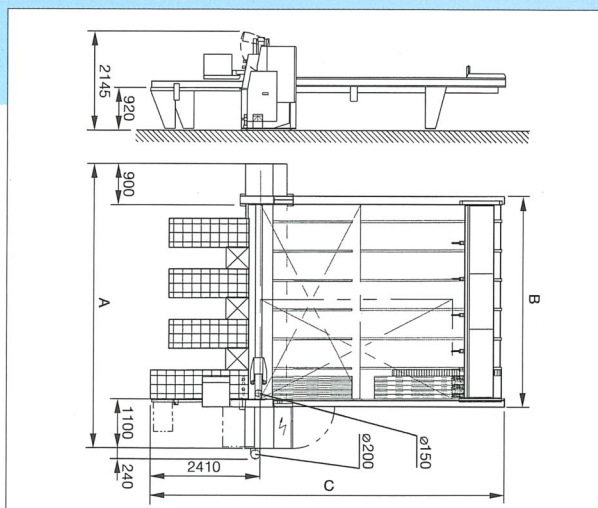

Etikettierung.

Informationsträger für den innerbetrieblichen Produktionsfluss.

Labelling.

Information for the entire production sequence.

Etiquetage.

Centre d'information pour tout le flux de production interne.

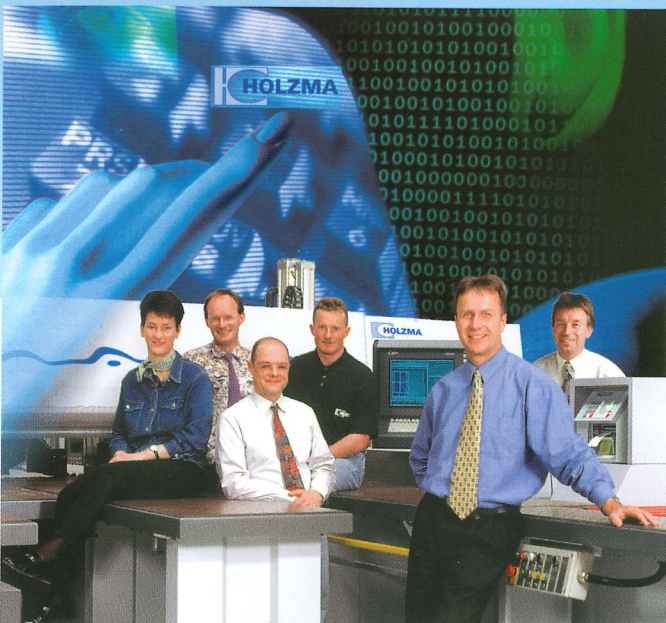
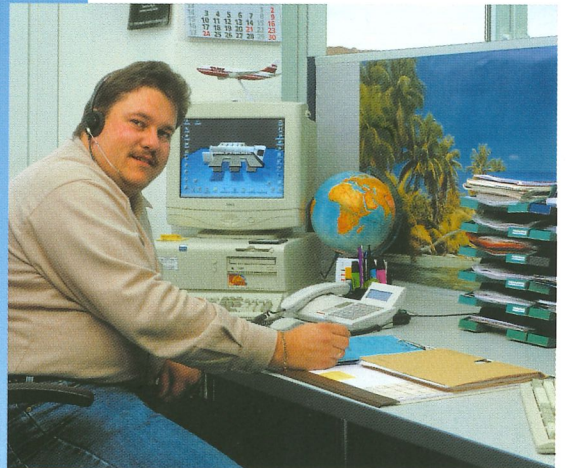

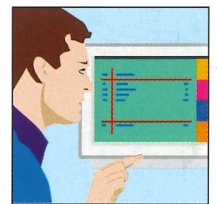
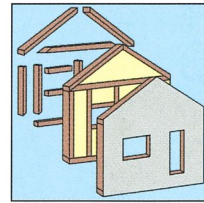
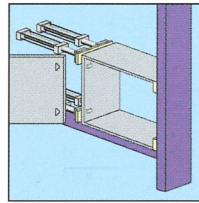
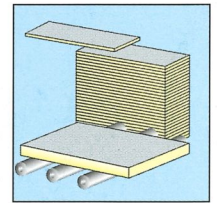
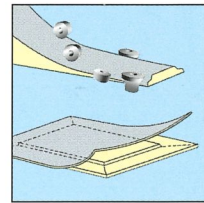
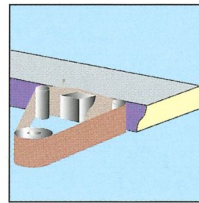
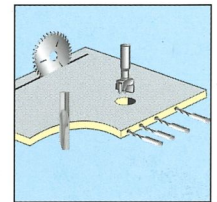
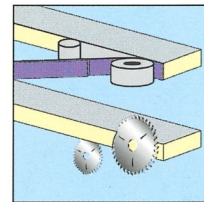
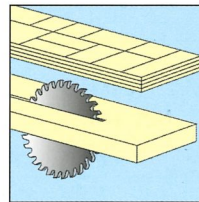

HOLZMA
Plattenaufteiltechnik GmbH
 Holzmastrasse 3
 D-75365 Calw-Holzbronn
 ☎ +49 (0) 70 53/69-0
 Fax +49 (0) 70 53/61 74
 info@holzma.de
 www.holzma.de



Niederlassung
 Dieselstrasse 73
 D-33442 Herzebrock-Clarholz
 ☎ +49 (0) 52 45/92 20 10
 Fax +49 (0) 52 45/92 20 44



HOLZMA=U.S., INC
 1200 Tulip Drive,
 Gastonia, NC 28052
 ☎ +1-704-861-8239
 Fax +1-704-867-4140
 holzmaus@stilesmachinery.com