

Routers BOF 300

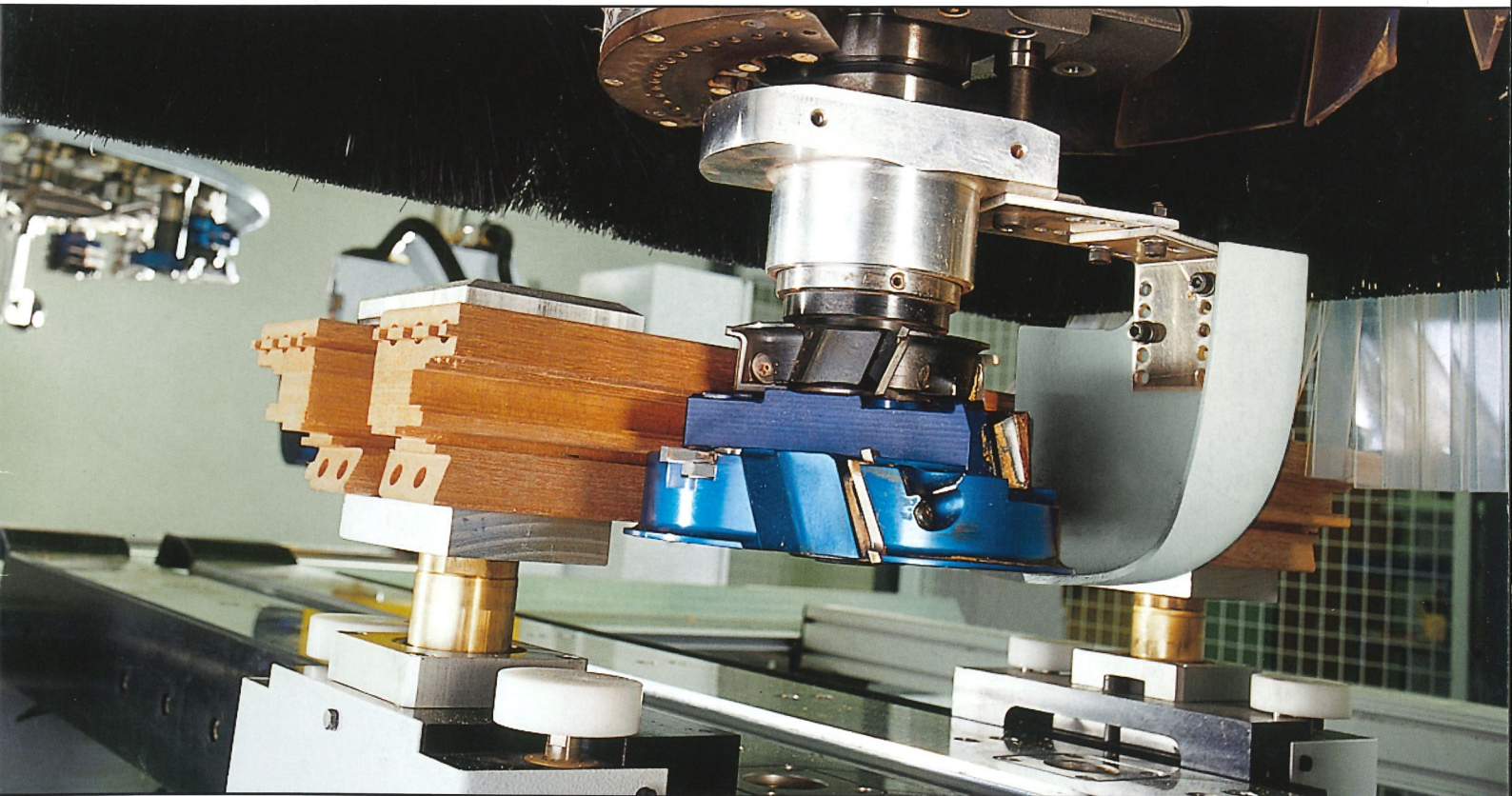

Optimat | profi line | power line



BOF 300 series routers: A new standard in excellence

Extreme versatility

Producing living room furniture components today, custom millwork tomorrow, a solid wood staircase component the day after – all in a day's work for the BOF 300 router series. Its outstanding benefit lies in the ideal combination of flexibility, performance and possibility for upgrading.

An extensive range of aggregate processing units will allow you to complete any order in record time and with outstanding quality. The unique double spindle (optionally) provides for the assurance of maximum productivity coupled with minimum space requirements.

From practical experience for practical application

Sizing, profiling, drilling, grooving or routing – all with a single machine concept which allows you to simply purchase the units you actually need. The BOF 300 series processing centres allow perfect processing of every kind of material: particleboard, MDF, coreboard, solid wood, acrylics and much, much more.

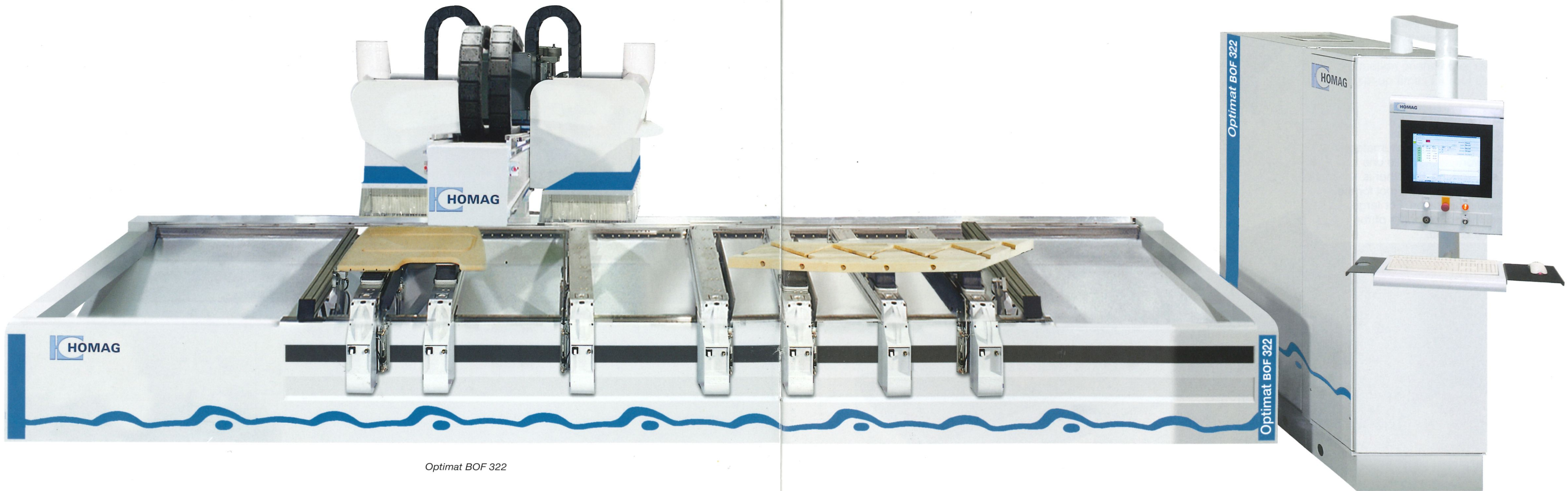

Optimat BOF 322

Performance and flexibility



Future and investment security

The BOF 300 series routers provide the ultimate answer to your production requirements. Your benefits at a glance:

- A machine concept capable of replacing several individual machines, with one complete and space-saving solution
- The capability to retrofit new units keeps you current with available technology
- Configured for maximum dimensional and material versatility
- Profitable even for producing small batch sizes
- Improved cut quality and less scrap, as workpieces can be processed on one machine – reducing the possible damage in multiple handlings

*Exchangeable, fully programmable 5-axis unit (**profi** line) for occasional 3-D machining and drilling at various angle (staircase production and front door hinges etc.)*

Individual processing and fast tool change

The two spindles are used alternately to process a workpiece. While one spindle is still working, the other is already being fitted with the tool for the next processing operation. For large workpieces, the entire length of the machine table is used.

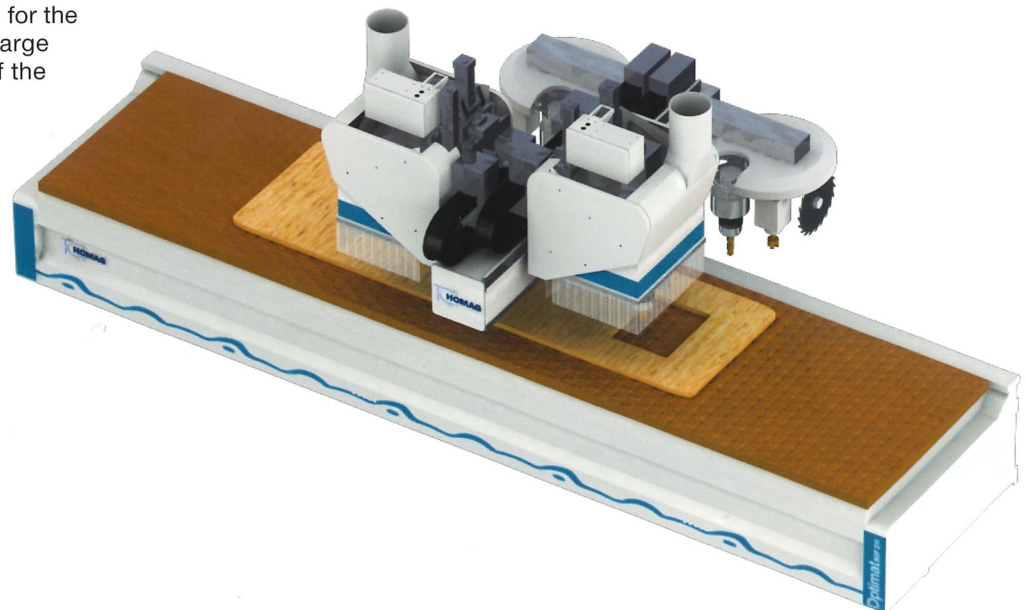

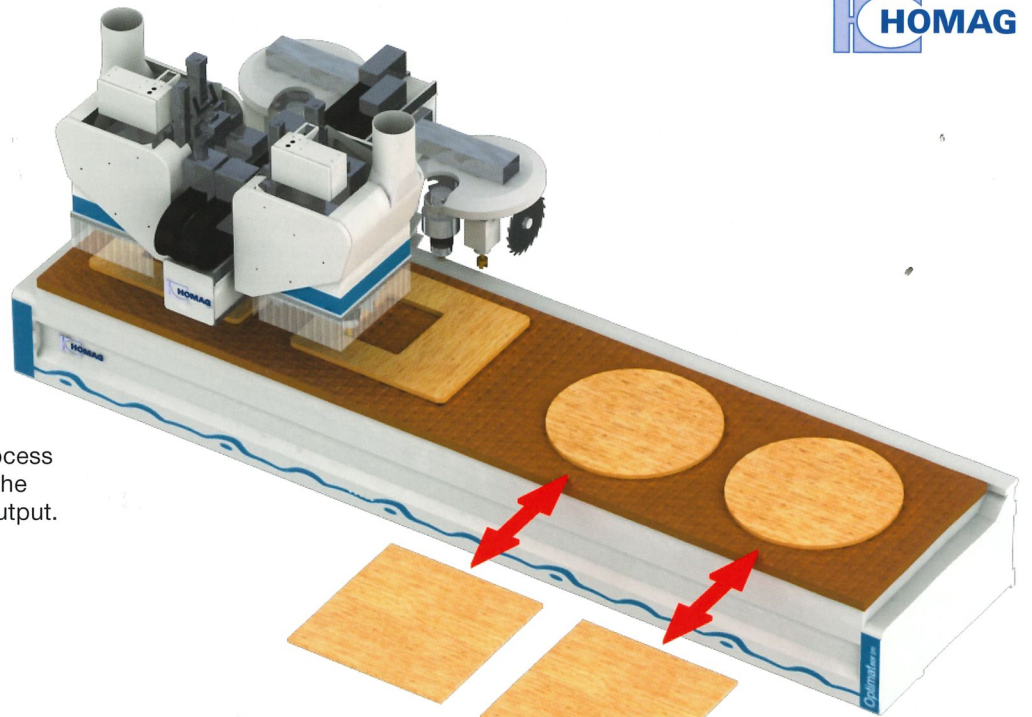

Synchronous processing in alternating operation

Two spindles synchronously process two workpieces on one side of the table, effectively doubling the output.

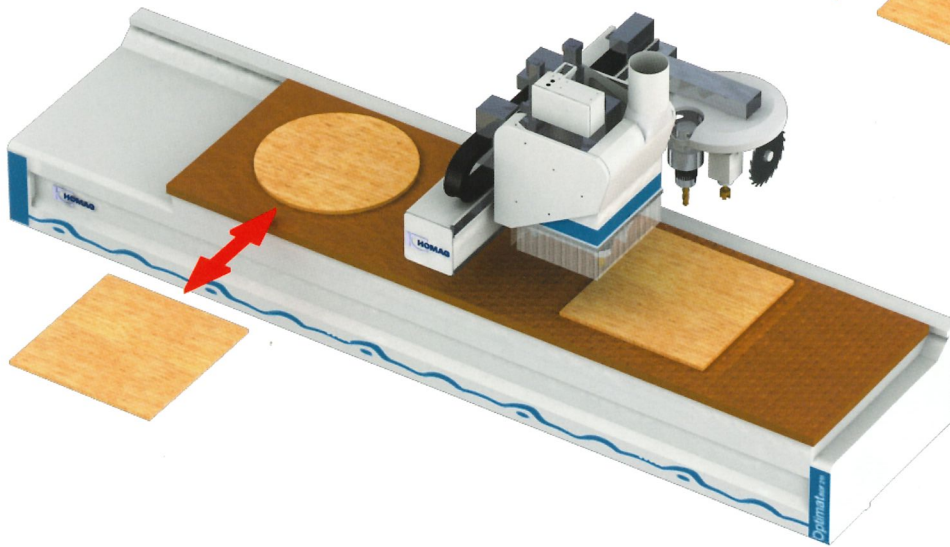

Individual processing in alternating operation

Simultaneous workpiece exchange on one side of the machine table and production on the other means cutting out set-up times for tool changeover.

Exchangeable horizontal drilling unit

For drilling holes in a single work process. The unit can rotate 360-degrees via C-axis with program control.

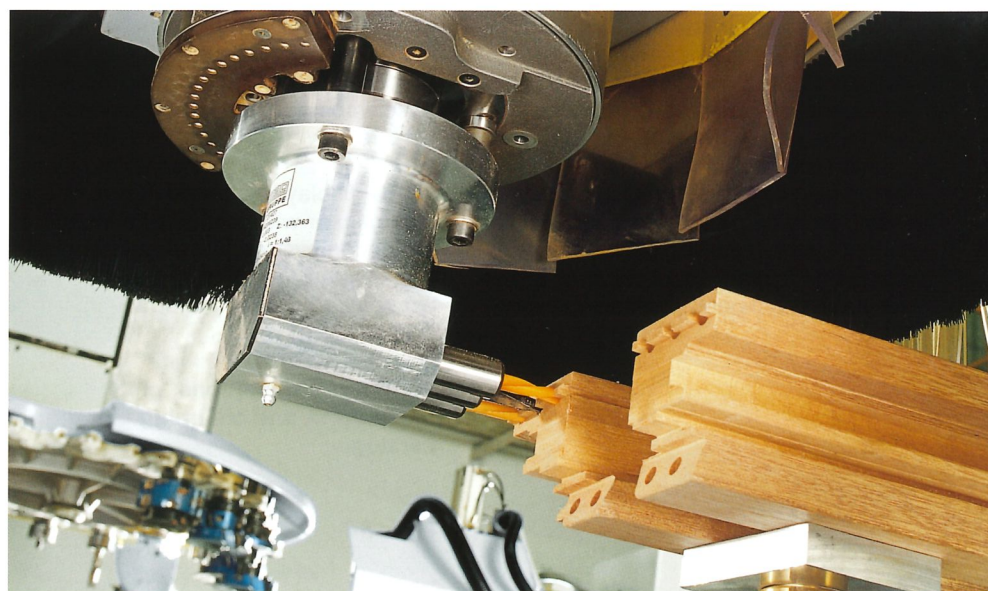
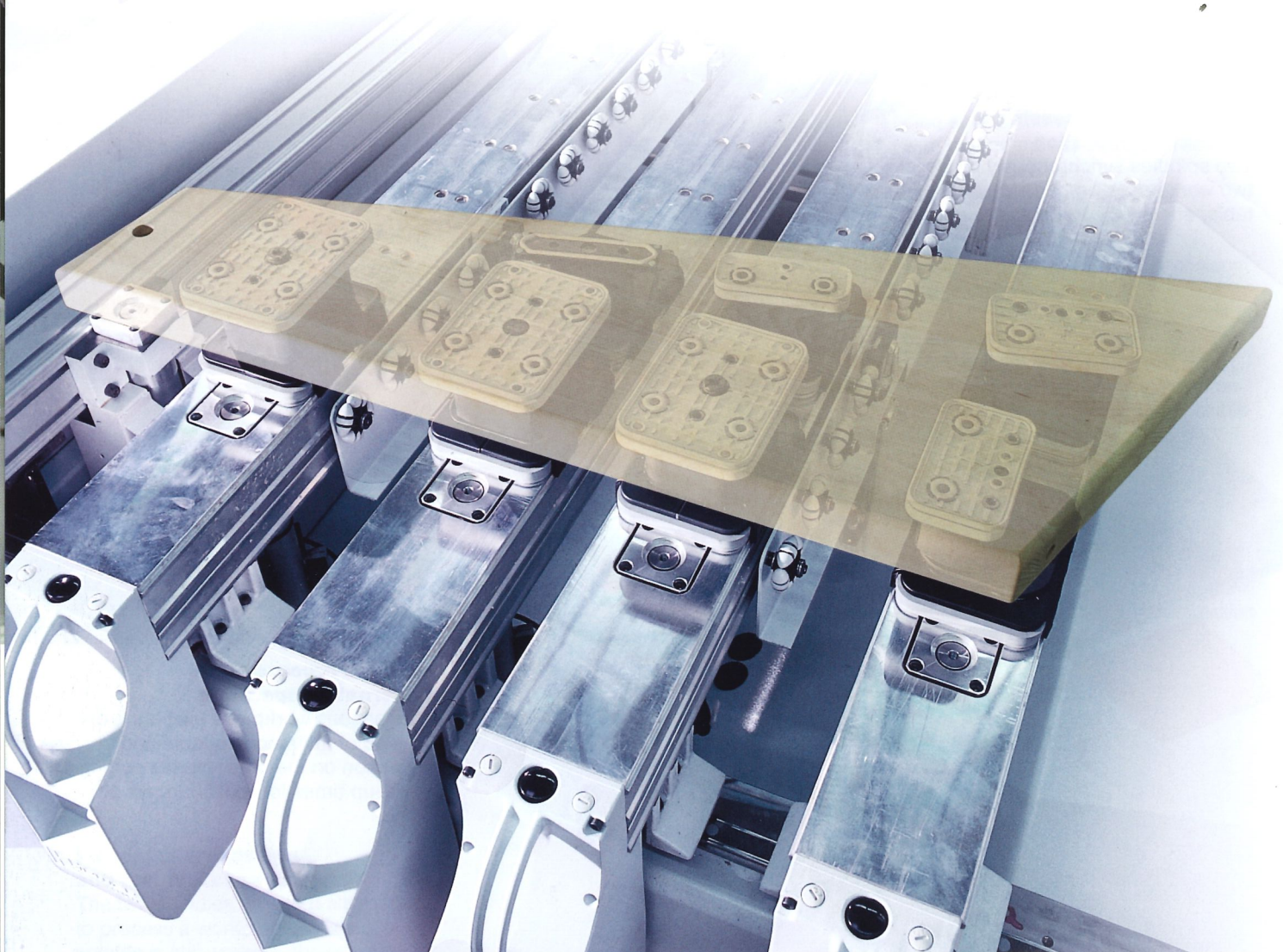

Table options to address your needs



K-table (Knee-type)

Clean and fast: The K-table

This is the ideal answer for flexible manufacturing. Every column can be adjusted by a quick manual operation. The benefits: Hoseless vacuum system with a variable number of vacuum clamps (pods). Both ends of the columns are fixed on precision guide-ways, permitting them to be moved without jamming. Precise fixturing of parts on the highly rigid columns allows for flexible, pin-point processing every time.

Workpiece positioning

Large diameter locating pins provide the precise standard solution for fast, simple workpiece positioning. To adapt the clamping fixture to any products, we offer a wide range of clamping elements. These can be positioned using a LED display integrated in one of the columns, or with the aid of a laser projection system. A ceiling-mounted laser system which also indicates the workpiece geometry is optionally available.

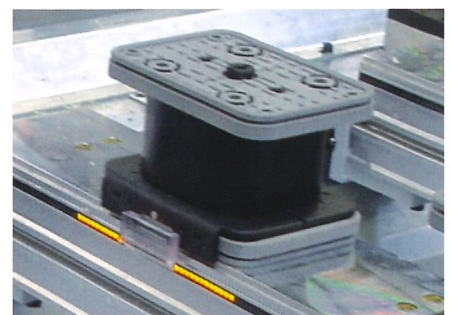

For other applications, please apply for our unit and clamping element catalog.

Increased output through flexible clamping systems

The development of a new exclusive suction cup platform for use with the K-table clamping system means it is now possible to move a hoseless suction cup along the column without the need to worry about the integrated suction points. This functional feature is made possible by a system of chambers

which suppresses leaks between the suction point and suction cup. The dual-circuit vacuum system permits the suction cup to be firmly fixed to the column, and then in a second stage, the workpiece to be fixed. This does away with unwanted movement of the suction cups when workpieces are positioned.



Locating pins with removable sleeves for workpieces with overhanging laminates (such as veneers). Alternatively, rotating pop-up locating pins with tabs for overhanging laminates are also available.

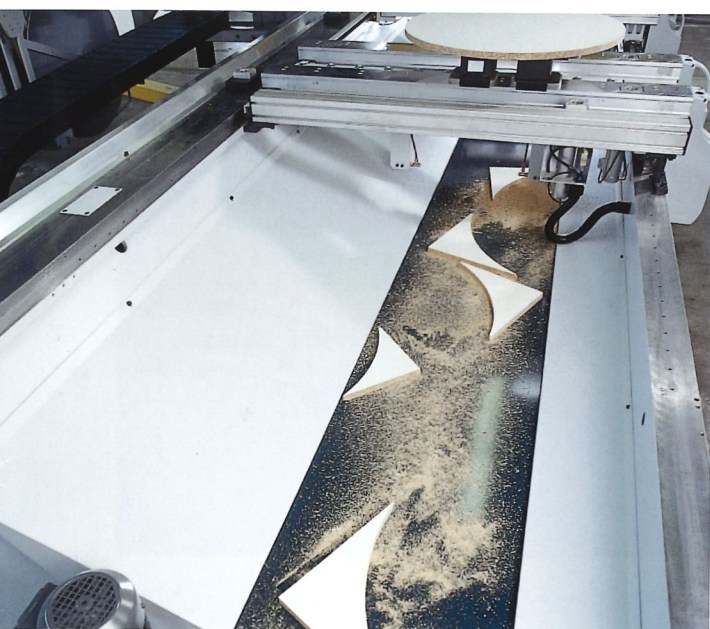

Conveyor belt for automatic waste disposal

Perspectives for window construction

Straight or curved

The universal clamping elements engage workpieces for square windows (individually or in pairs) or for non-standard windows.

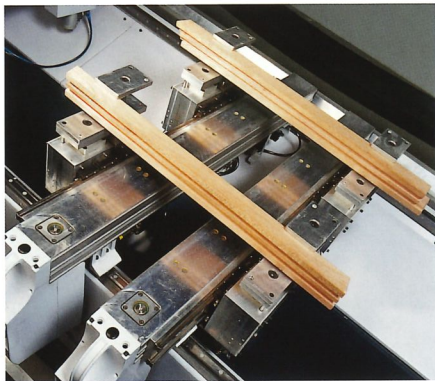

Automatic re-clamping fixture (*profi line*)

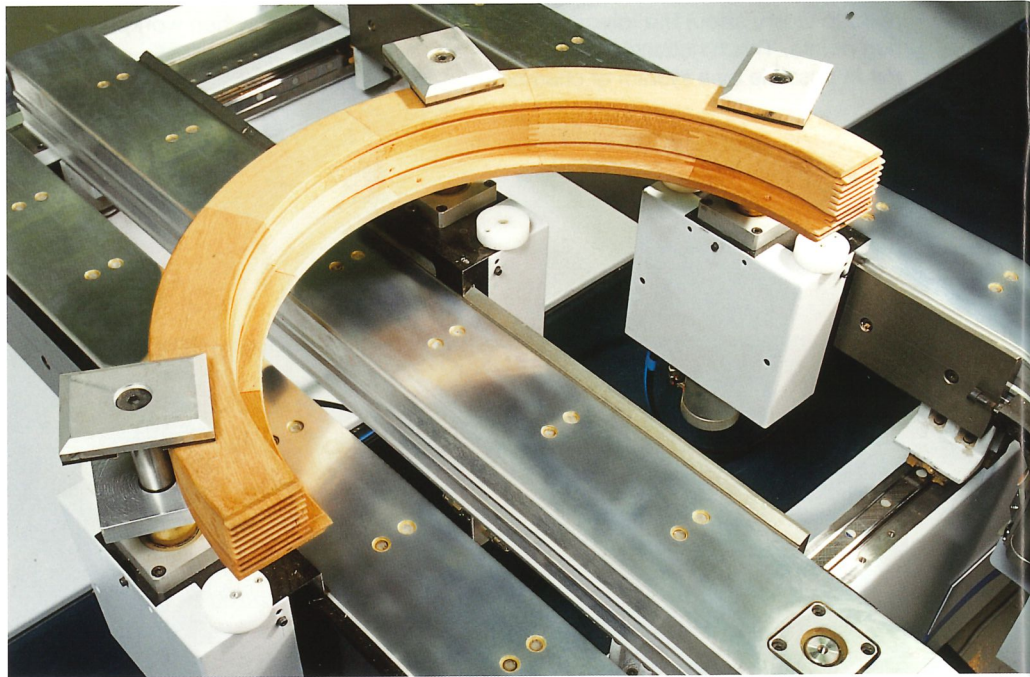

Manual clamping fixture

Multiple workpiece positioning: saving times

The transverse columns, each equipped with one or two mechanical-pneumatic clamping elements, offers the possibility for dynamic space allocation. The individual parts are grouped together depending on their length and profile geometries to create optimum layouts, so making the best possible use of the available machine bed length. This permits tool change times to be minimized.

Tear out-free processing

Tear out or splintering during profile cutting on the face side is nearly eliminated as a result of using optimized approach movements, or lead-ins and lead-outs.

The clamping system for straight and curved window components. Flat-panel components can be clamped using suction cups. During this flat-panel processing, the clamps are lowered.

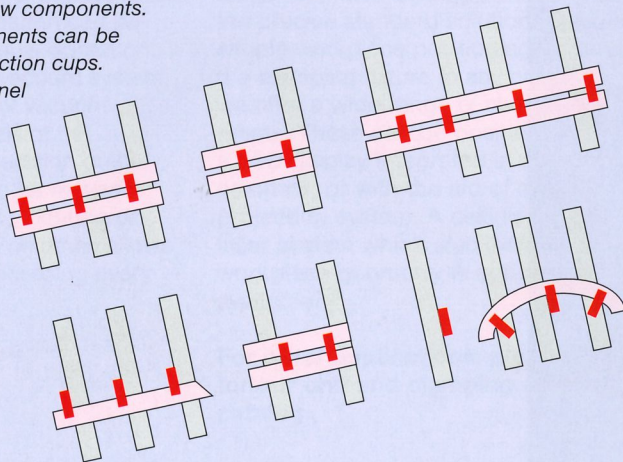

Automatic reclamping of individual components for doublesided processing:

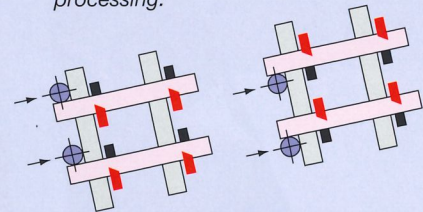

AutoClamp KC-table – less set-up, more performance

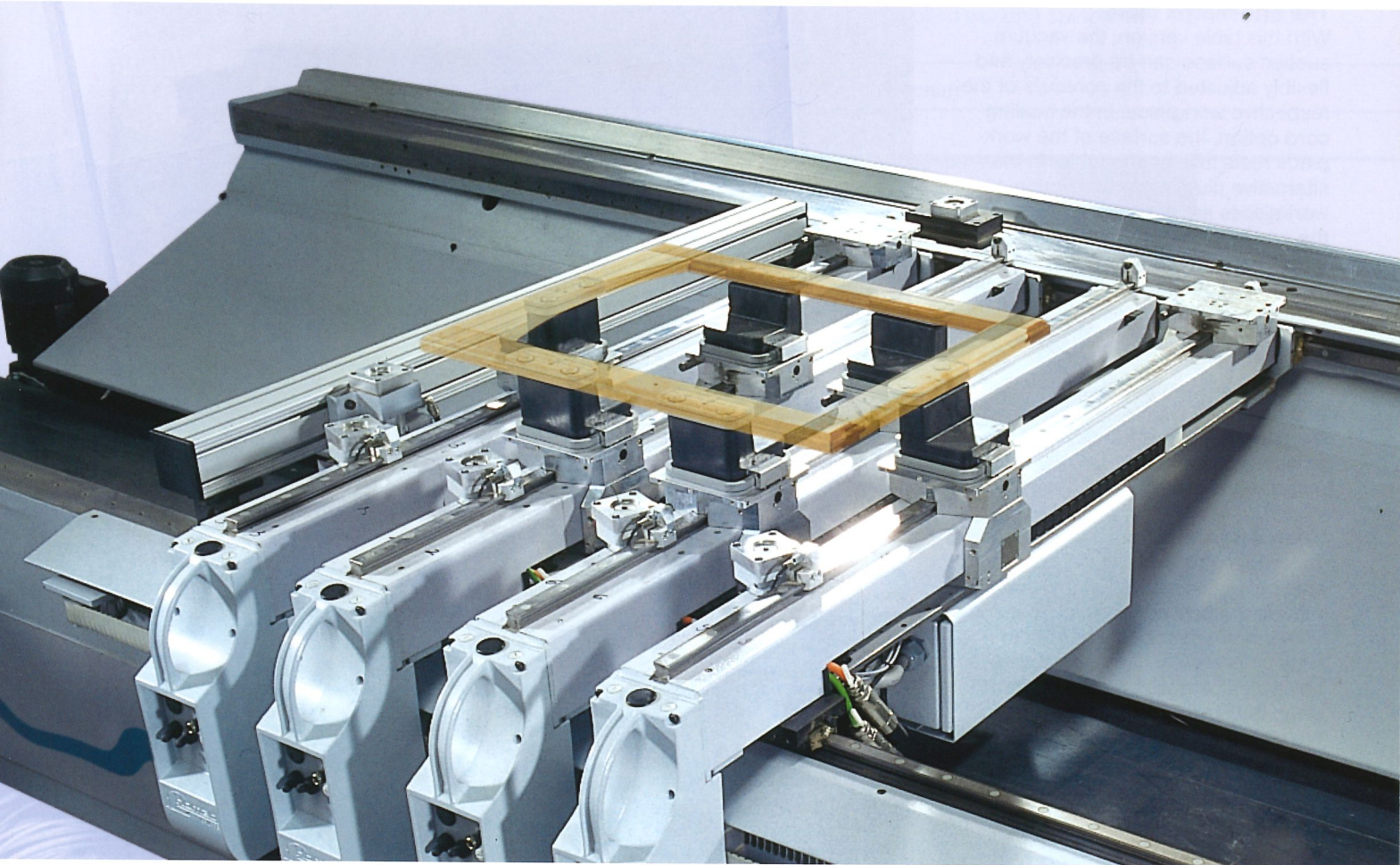

AutoClamp table

Fully automatic: the patented AutoClamp knee table

The newly developed AutoClamp knee-type table allows automatic table set-up including precisely positioned clamping elements. The benefits in practice: Resetting the work table during workpiece changeover reduces downtimes and ensures high output even for batch sizes as small as 1. It also permits upgrading to create a production cell. Different suction cup shapes can be used to accommodate varying workpiece geometries.

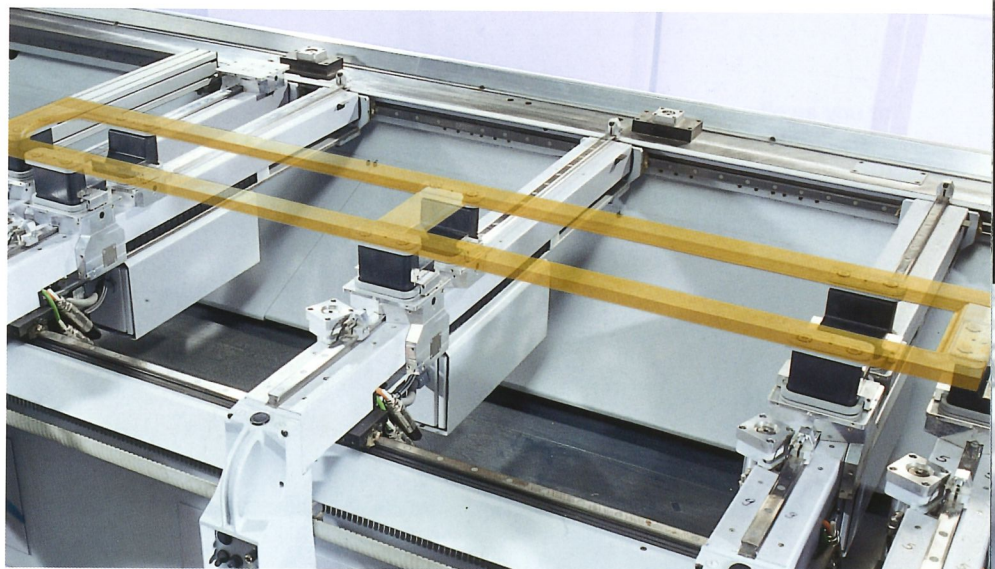

R-table (Grid-matrix) – the universal standard option

The grid-matrix table

With this table version, the vacuum suction surface can be precisely and flexibly adjusted to the contours of the respective workpiece. In the sealing cord option, the surface of the workpiece rests fully on the table. In the alternative plug-in module option, the workpieces are clamped 20 mm above the grid table, so allowing the narrow edges to be processed. Locating pins or fences (optionally) additionally permit precise workpiece positioning on the work table.

The unique design of the aluminium grid table with dovetail grooves permits the positive-locking fixture of clamps for reliable workpiece fixture even when subjected to extreme hogging forces.

Nested Based Manufacturing (NBM)

The grid-matrix tables can naturally also be combined with high-powered vacuum pumps for nested applications. With optimised vacuum flow, this solution proves to be ideal for workpiece clamping with “bleed boards” using the nesting technique. We offer a special software solution for this application (woodNest).

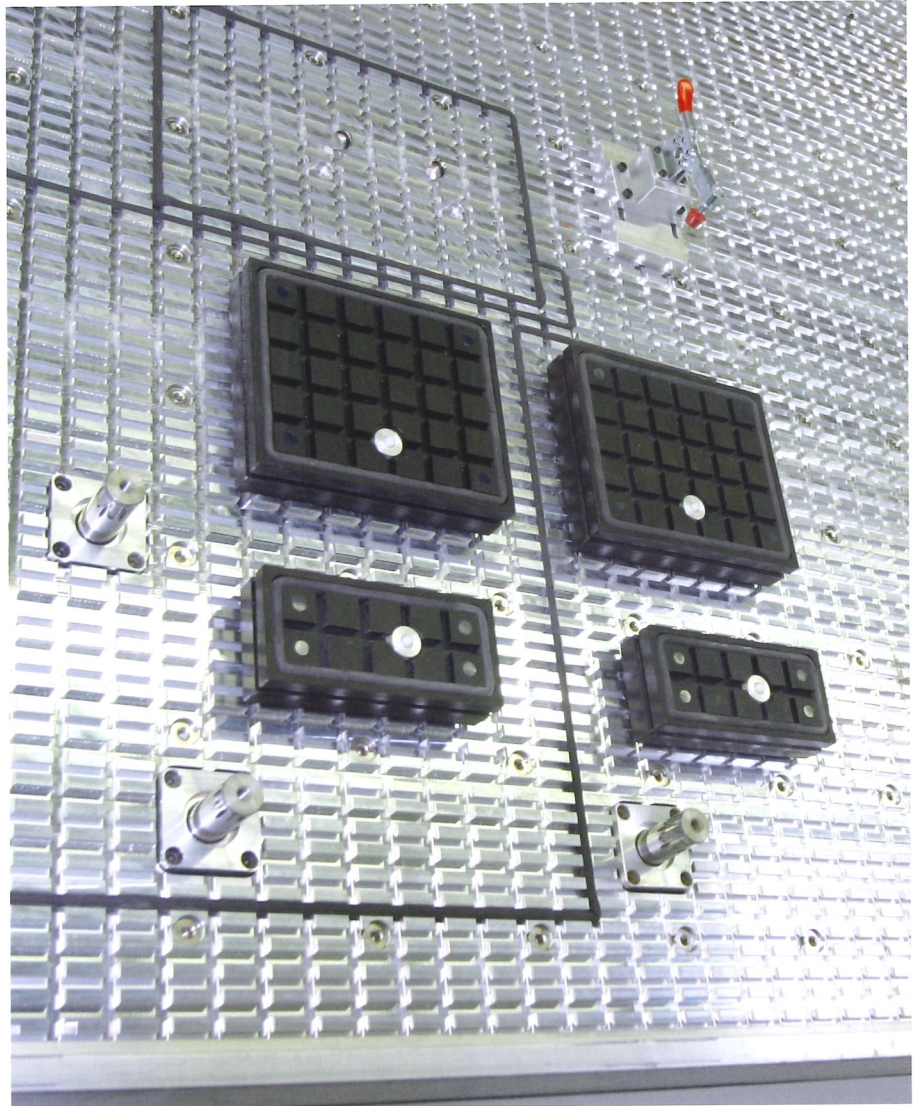

Suction cup (sealing cord for flexible clamping of workpieces.)

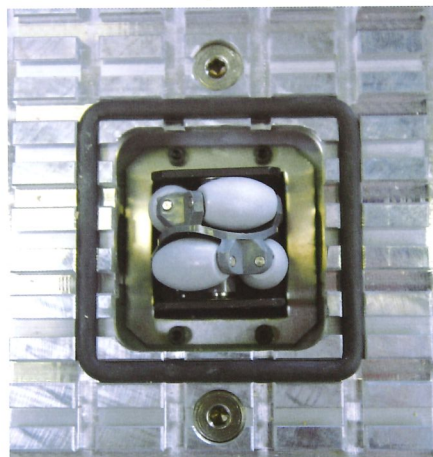

Integrated transport roller e.g. for handling of the “bleed boards” during Nesting.

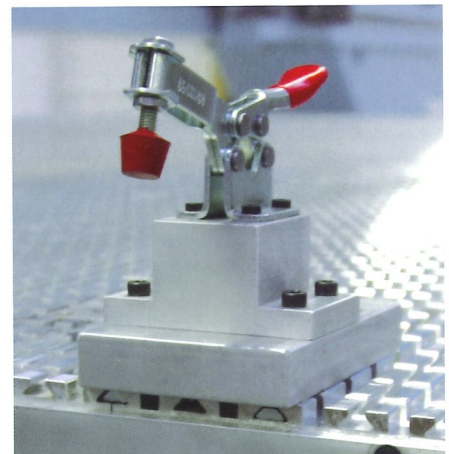

Toggle clamp with T-block for positive locking fixture in grid grooves.

Spindle control for perfect results

Highlight on "Vector Spindle technology"

The use of a controlled spindle featuring electronic speed monitoring (closed-loop feedback) offers a whole range of benefits:

- Electronically monitored power input protects the spindle from damage due to non-homogeneous materials (such as knots in the wood)
- HSC technology for higher cutting feed rates and optimum surface quality due to revolution speeds of up to 30,000 rpm
- No loss of speed under load, guaranteeing a consistent cutting rate and surface quality
- Full torque, even at low speeds (e.g. when sanding)
- Liquid cooling of the spindle for constant operating temperatures and a longer service life
- Highly precise, standardized tooling interface HSK-63F
- Three-point interface for aggregate attachments
 - Power transmission from the main spindle
 - Optional C-axis (the units inserted in the main spindle's long-life ceramic bearings can be optionally rotated by program and swivelled for cuts and drilling processes at any angle)
 - Pneumatic transmission (e.g. to blow away chips or to control tracing units)

The Homag added bonus

Exclusively from Homag: The BOF 300 router is also available as the BAZ 300, allowing for contour edge banding and finish processing.

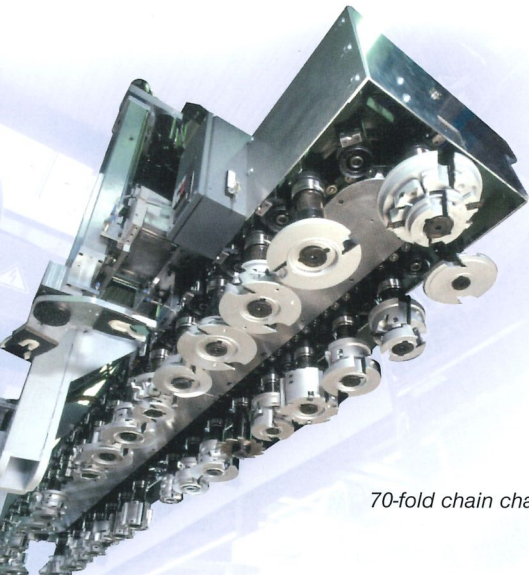

70-fold chain changer

- > **Main spindle** External drive via controlled working spindle with 7.5 or 14.5 KW (10 or 19,5 HP)
- > **C-axis** C-axis for rotation (optional)
- > **Pneumatic** Pneumatic supply

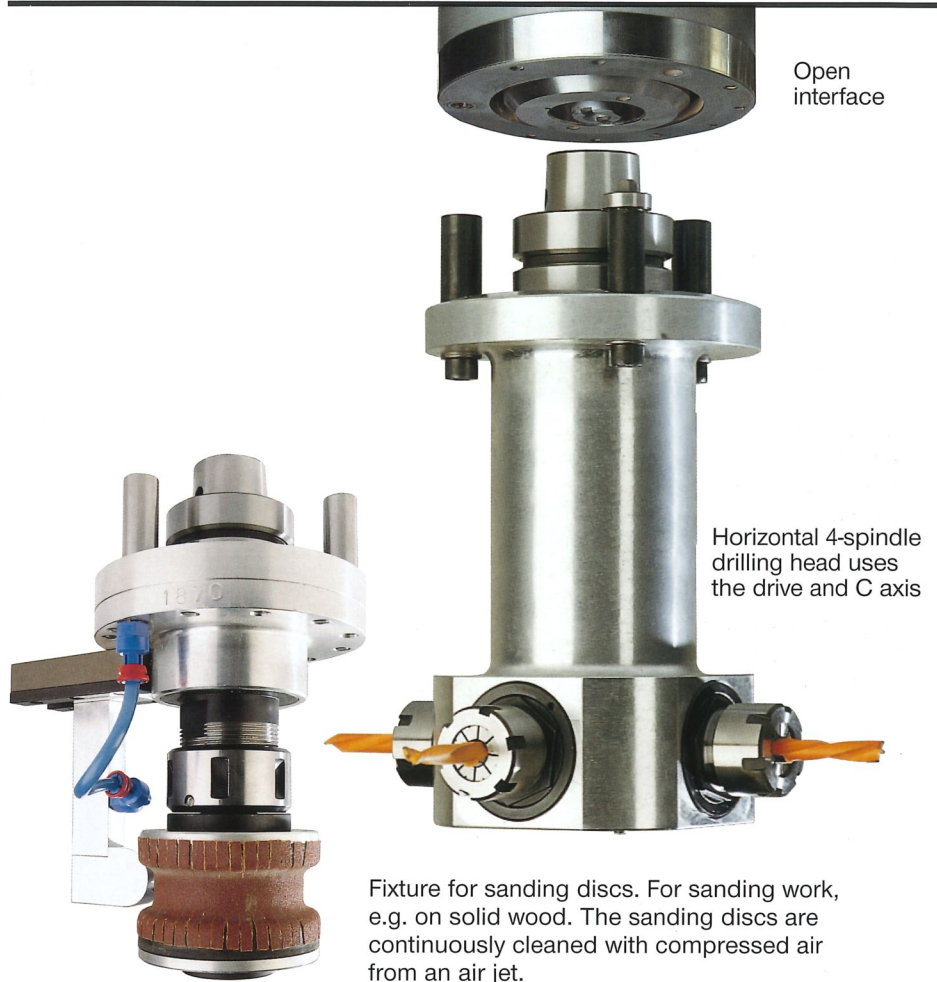

Fixture for sanding discs. For sanding work, e.g. on solid wood. The sanding discs are continuously cleaned with compressed air from an air jet.

Performance on demand: The tool changers

A wide range of efficient tool changes is available depending on requirements. The 12-fold plate changer provides a low-cost solution for the provision of up to 12 tools and units. An 18-slot plate changer and a 30-slot or 72-slot chain changer are available.

The patented interface allows you to add units as needed. For details of the wide range of units available for use with the interface, please refer to our separate unit and clamping element catalog.

A drilling head with an extra dimension of flexibility

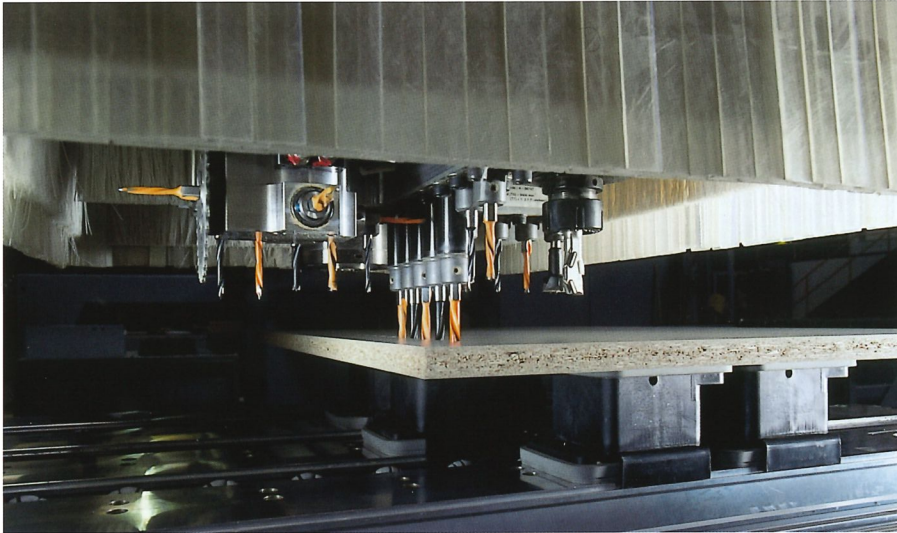

Upgradeable drilling head

The modular drilling head is optionally configured with either 12 or 17 vertical spindles. The standard double spindle bearings and cam-lock system provide the drilling head greater rigidity. In addition, one or two adapter units can be mounted. The benefit: this allows more tools to be used without changing the primary drilling unit or extend the number of vertical spindles up to 29.

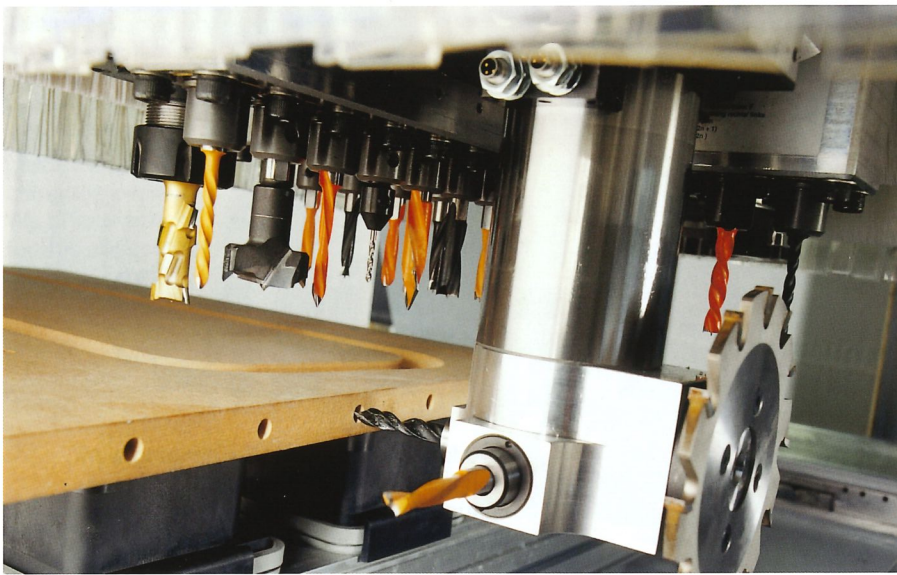

Adapter 4-spindle drilling head + saw

Three drills of different diameters for horizontal drilled hole and grooving saw blade can be optionally deployed in both the X and Y direction (optionally: 0-90 degree swivel facility).

For details of other available adapter units, please refer to our unit and clamping element catalog.

Adapter routing spindle

To reduce cycle times, an additional routing tool can be deployed directly without the need for an automatic tool changer.



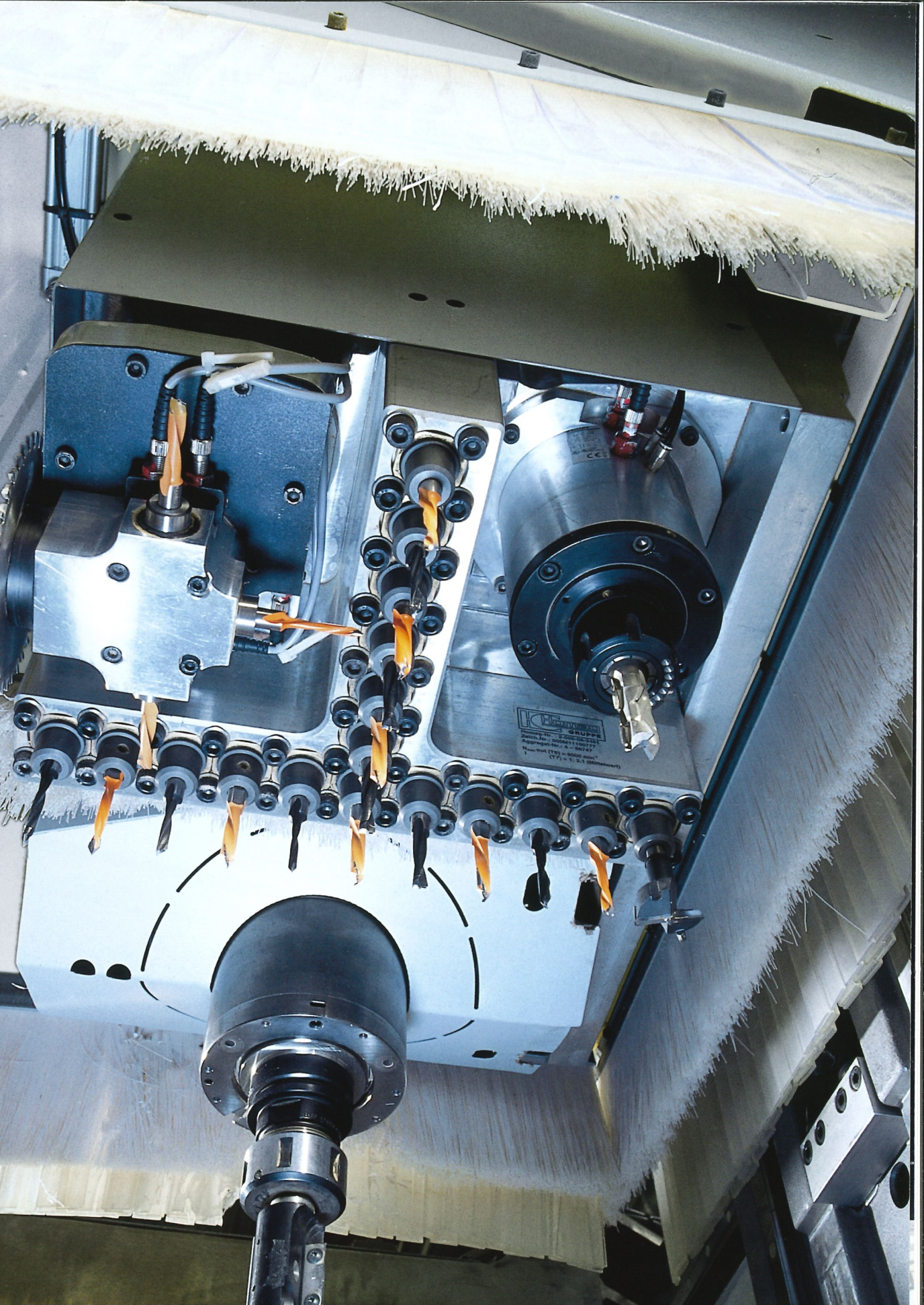

WILHELM
GRUPPE
Hauptstr. 2, 22603 Cuxhaven
Telefon: 04841 130977
Telefax: 04841 130977
Hersteller (T2) = 9000 0000
LT 1 = 1:1 (Brennwert)

Simple control – automatic optimization

The Homag **power** control system PC85 is an open-ended and flexible control system for highly complex applications coupled with outstanding operating simplicity. The latest generation allows efficient combination of all machine-operating modes (alternating, synchronous and individual operation). Integration of different program steps (tool change optimization) occurs while processing takes place as a result of **Intelligent Process Optimization (IPO)**, meaning that ultra-efficient production is possible from as low as batch size one.

To allow the programs to be accessed in accordance with the workpiece sequence, an integrated job list control system is provided.

woodWOP – rationalization through fast programming

The wood working industries most popularly programming system in the woodworking industry offers outstanding support for optimum machine operation. Starting from the graphic tool database as an overview for existing tools, through the import of CAD drawings and data from trade-specific software packages (optional).

Machine data acquisition

Alongside a reliable machine, high performance is dependent upon environmental factors. To analyse and optimize organizational integration and material flow, the PC85 control system comes equipped with a basic machine data acquisition version as a standard feature. A professional version is optionally available which opens up scope for detailed evaluation and feedback to higher-level management systems.

Tool service life determination

In order to cut ancillary costs, a tool life management function is optionally available. This allows you to optimize your tool inventory and the associated upkeep costs.

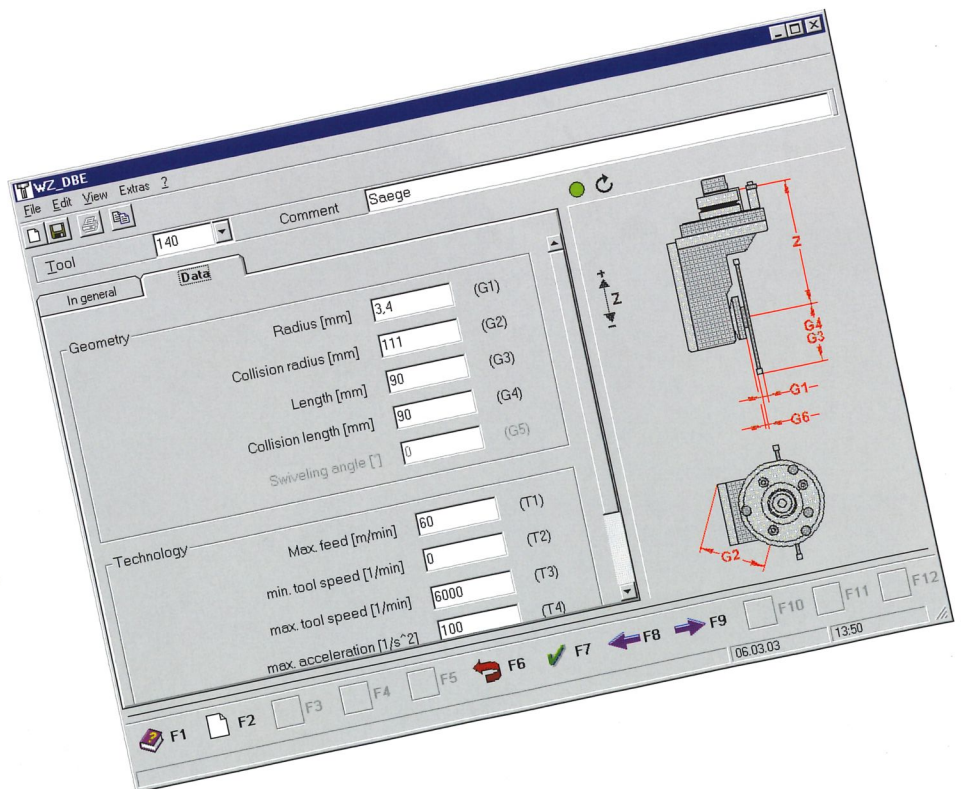
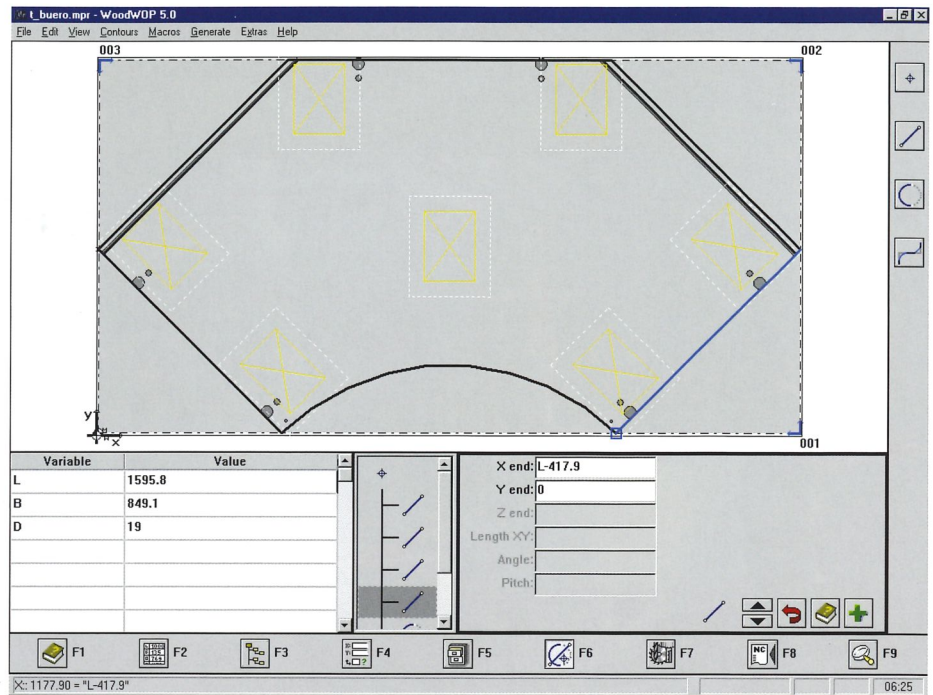

HOMAG

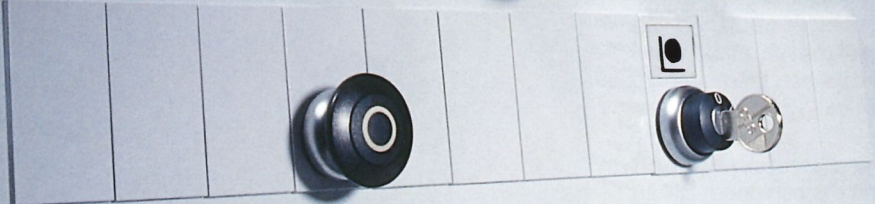
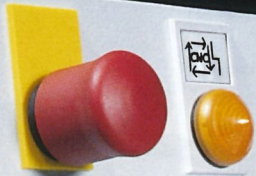

Software solutions from Homag

Integration made possible

Interfaces are optionally available which permit the integration or coupling of trade-specific software packages. This allows utilization of existing data from the production engineering department.

woodDesign

The woodDesign allows the fast graphic entry of carcass furniture designs into the system.

woodScout – Help in a language you understand

In case of error or faults, the unique diagnostic system (optionally) provides an invaluable aid, graphically displaying the location of the fault at the machine and releasing an error message in easily understandable text.

woodNest

Software for shaped component nesting to optimize cutting waste.

woodWOP DXF interface

For the import of workpiece geometries and defined processing operations from CAD systems in the international DXF format.

All from a single source

Additional software products round off the wide performance spectrum of woodWOP. More detailed information is available on request.

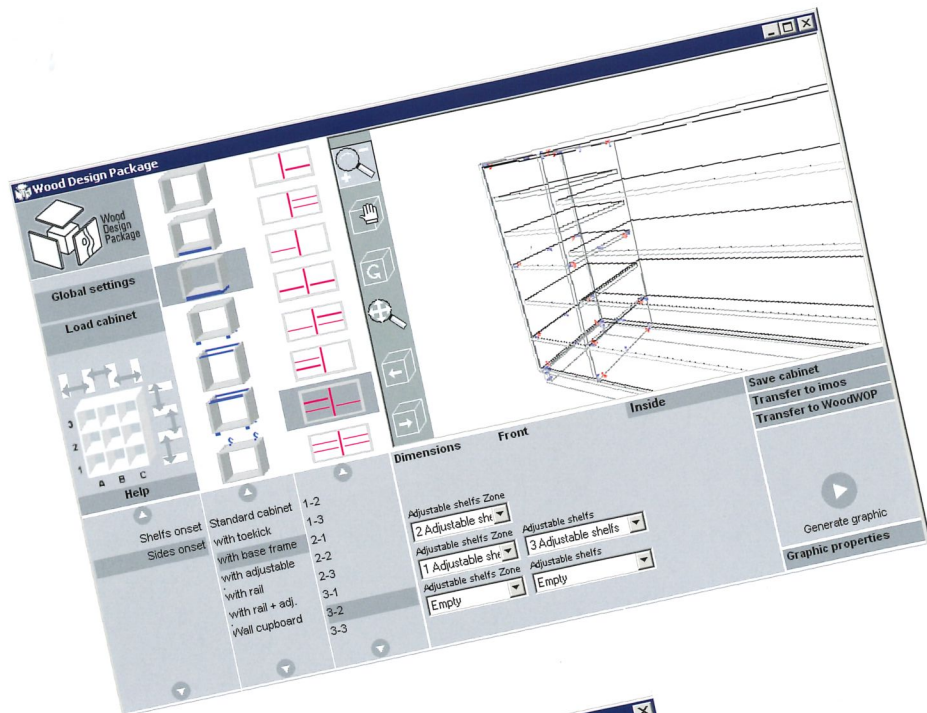

It pays to be a Homag customer



Homag is everywhere

A well-developed servicing, sales and dealer network means even greater proximity, rapid response and improved customer support – all over the world.

Practically-oriented training

Although Homag products are designed for outstanding operating simplicity, thorough training does help cut down on commissioning times, reduces scrap from trial and error, helps develop the skills of the operator and generally improves efficiency.

With this aim in mind, customer training courses are held in a number of languages in our own training centre.

Careful maintenance

Scheduled, correctly performed maintenance helps reducing costs and increasing the productivity and service life of plant and machinery.

Identical parts, simple handling

A large number of the parts, control elements and assemblies used in Homag Group plants and machines are identical. The wide-ranging benefits of this policy include simplified operation, lower costs, streamlining of spare parts management and also faster maintenance and servicing – to name only a few.

Remote diagnosis worldwide

All NC machines are fitted in the factory with a modem to allow remote diagnosis anywhere around the globe. A search for possible faults is performed from the Homag Service Centre. Once localized, they are narrowed and often already solved over the phone.

Models to address every need

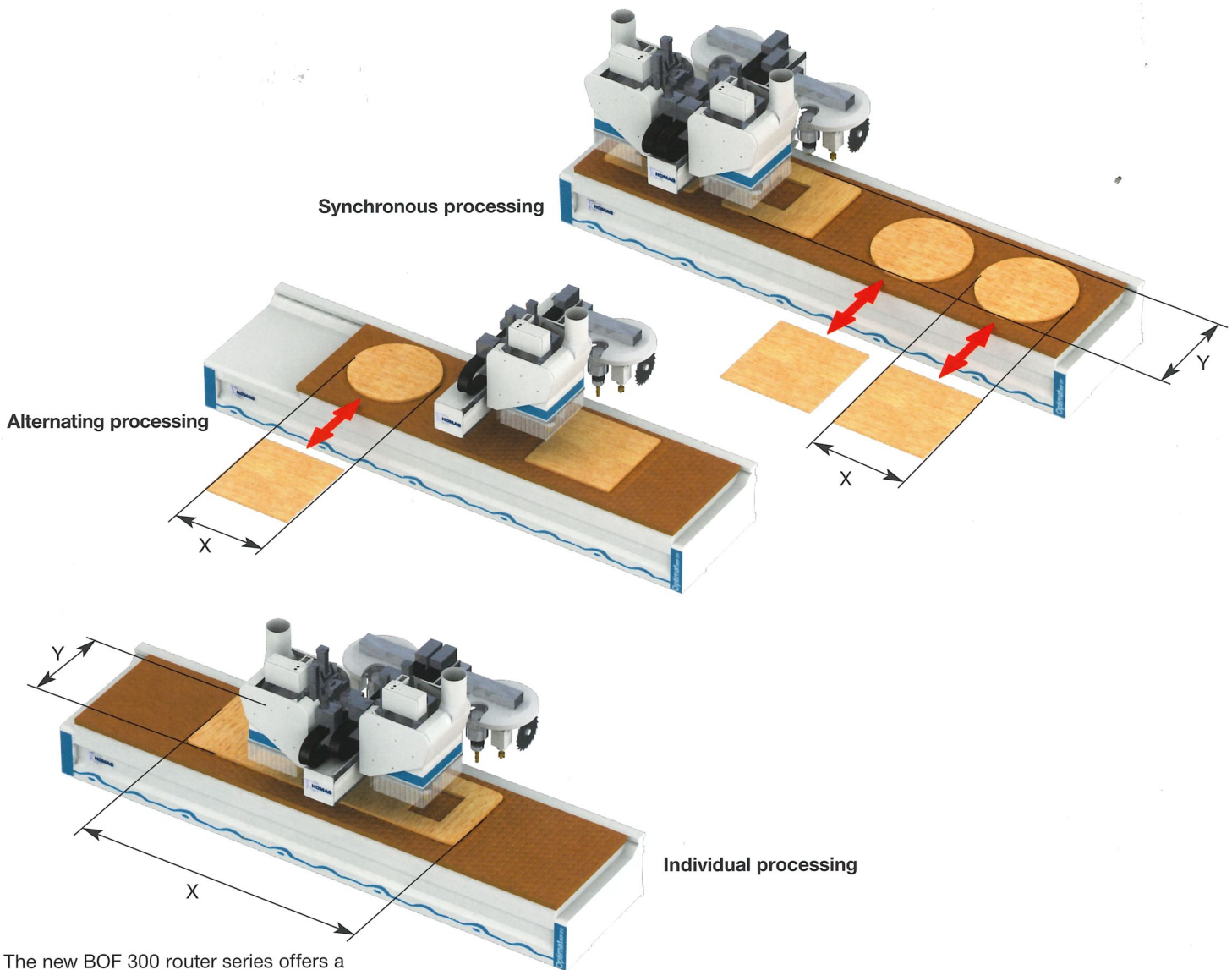

The new BOF 300 router series offers a wide product range with a choice of 9 different standard models. For larger processing dimensions, please enquire about our BOF 700 routers.

Processing dimensions	Optimat		profi line
	BOF 311 Grid table	BOF 322 Grid table	BOF 311 PM Knee table
X = Max. processing widths with tool diameter 25 mm:			
Individual processing type 30 [mm]	3320 (130")	-	3050 (120")
Individual processing type 40 [mm]	4280 (168")	-	4000 (157")
Individual processing type 52 [mm]	5840 (215")	5200 (204")	5200 (204")
Individual processing type 60 [mm]	6320 (248")	6320 (248")	6000 (236")
Individual processing type 72 [mm]	7520 (296")	-	7200 (283")
Alternating processing type 30 [mm]	1210 (47")	-	1075 (42")
Alternating processing type 40 [mm]	1695 (66")	-	1550 (61")
Alternating processing type 52 [mm]	2295 (90")	2765 (108")	2150 (84")
Alternating processing type 60 [mm]	2715 (106")	2715 (106")	2550 (100")
Alternating processing type 72 [mm]	3315 (130")	-	3150 (124")
Synchronous 4-workpiece processing type 40 [mm]	-	1260 (49")	-
Synchronous 4-workpiece processing type 60 [mm]	-	1100 (43")	-
Y = Max. processing depths with tool diameter 25 mm			
Standard [mm]	1700 (67")	1700 (67")	1700 (67")
Option secondary spindle with knee extension (knee table) [mm]	-	-	2000 (78")
Max. working heights			
Routing operations including clamping elements [mm]	300 (11,81")	300 (11,81")	300 (11,81")
Remark: Processing dimensions are dependent upon workpiece positioning			

Compact performance

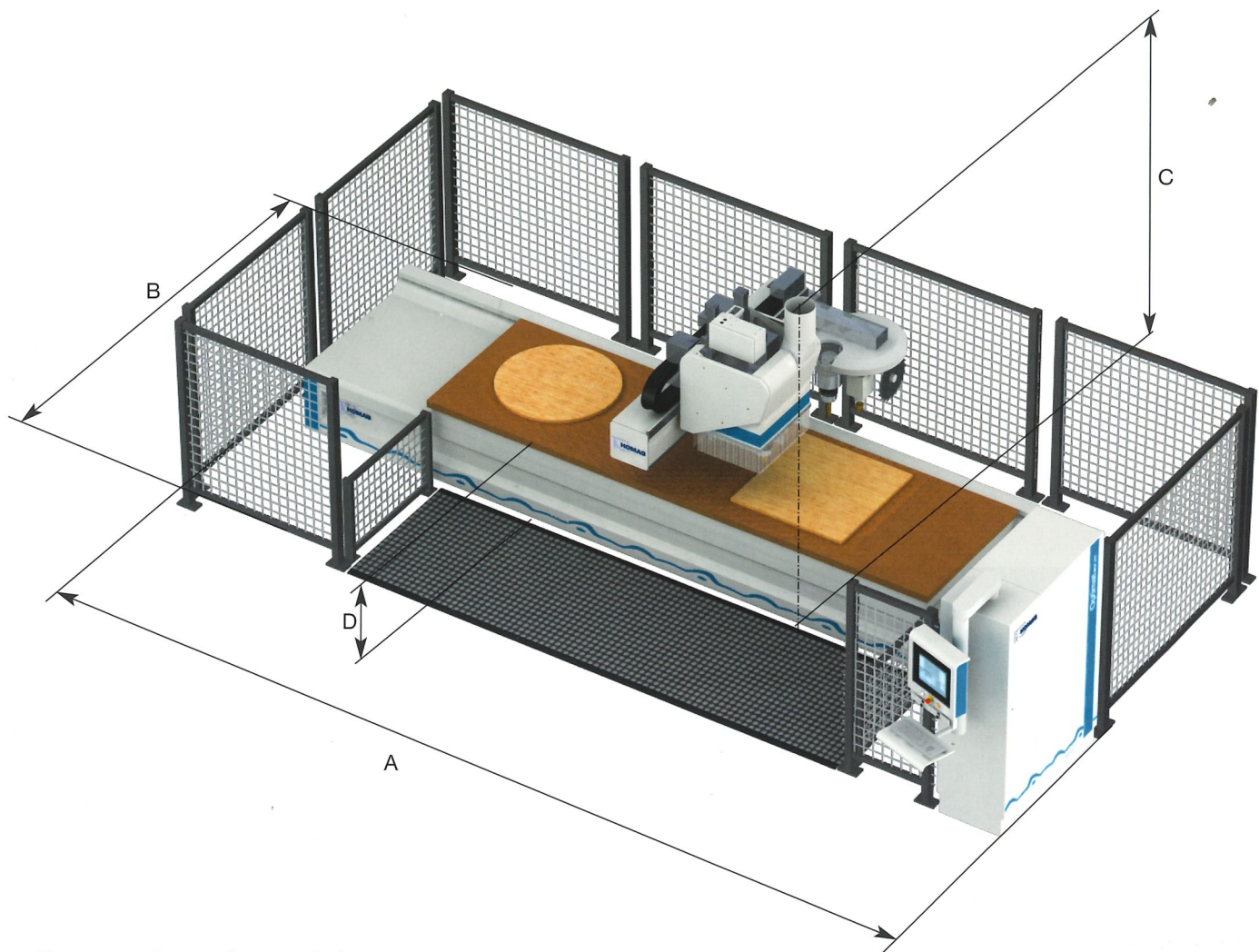

The compact extension arm design offers a large work area coupled with low space requirement.

Set-up dimensions and connected loads	Optimat		profi line
	BOF 311 Grid table	BOF 322 Grid table	BOF 311 PM Knee table
A = Length for type 30 [mm]	6750 (265")	-	6750 (265")
A = Length for type 40 [mm]	7750 (305")	-	7750 (305")
A = Length for type 52 [mm]	8750 (345")	10000 (394")	8750 (345")
A = Length for type 60 [mm]	9750 (384")	12000 (473")	9750 (384")
A = Length for type 72 [mm]	10250 (424")	-	10250 (424")
B = Width [mm]	4750 (187")	5000 (197")	5250 (207")
C = Height [mm]	2900 (114")	2900 (114")	3000 (118")
D = Working height [mm]	850 (33,46")	850 (33,46")	950 (37,4")
Extraction output [m³/h]	5000 (2940 C.F.M.)	5000/10000 (2940/5880 C.F.M.)	5000 (2940 C.F.M.)
Extraction port diameter [mm]	250 (9,84")	2 x 250 (9,84")	250 (9,84")
Compressed air consumption [NL/min]	400 (14 C.F.M.)	800 (28 C.F.M.)	400 (14 C.F.M.)
Electrical connected load [KW]	from 15 (20 HP)	from 26 (20 HP)	from 15 (20 HP)

Specification and photo details without commitment. We reserve the express right to make changes in the interests of progress.



A member of the Homag Group



Homag Holzbearbeitungssysteme AG

Homagstraße 3-5
72296 SCHOPFLOCH
GERMANY

Tel.: +49 7443 13-0
Fax: +49 7443 132300
E-Mail: info@homag.de
Internet: www.homag.com

