

360° freedom. Unlimited possibilities.

HOMAG

Our CNC Processing Center
CENTATEQ P-110

YOUR SOLUTION

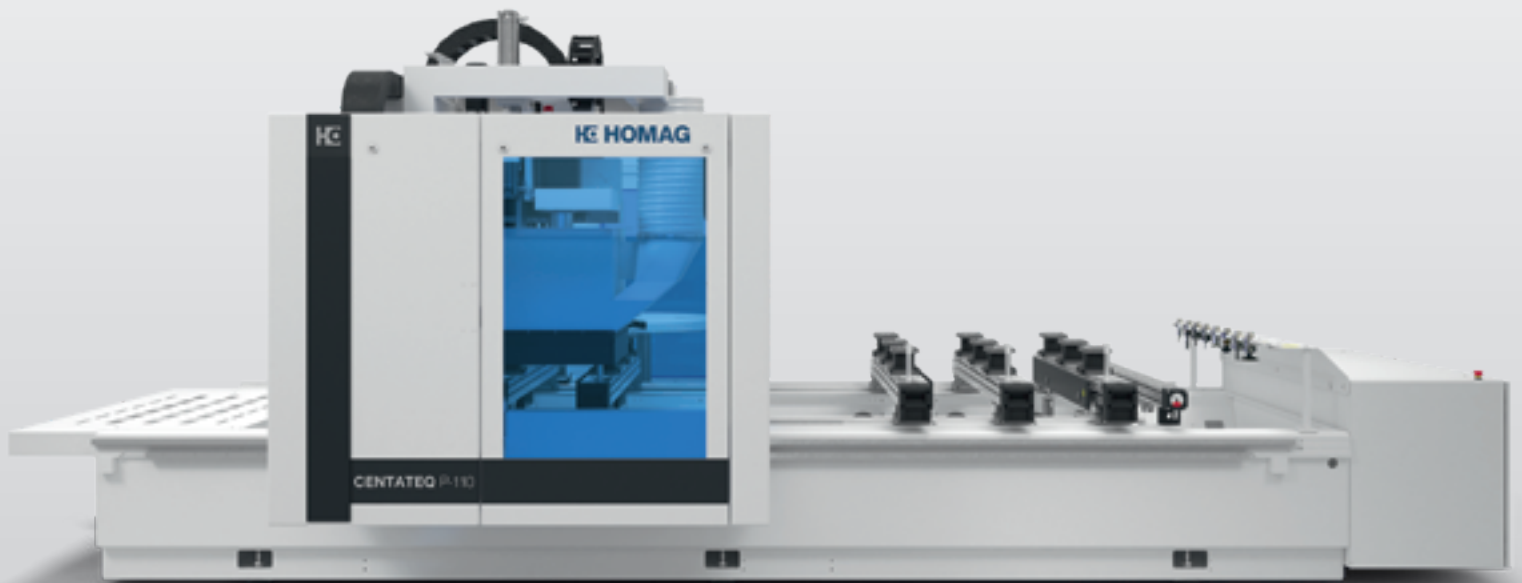





CENTATEQ P-110 – small space, big possibilities

Compact technology, a reduced footprint and operational convenience next to the machine – these are the cornerstones of the machine concept. You will find 3-, 4- and 5-axis solutions. For entering the world of sophisticated horizontal CNC processing.

YOUR SOLUTION

CONTENTS

- 04** The Concept
- 06** 360° more freedom
- 07** Option: Convenience Package
- 08** Quality
- 10** Applications
- 12** HOMAG drilling technology
- 14** Routing spindles
- 16** Tool changer systems
- 18** Aggregates
- 20** Console table
- 24** Matrix table
- 28** Software
- 30** powerTouch2
- 32** tapio
- 34** Life Cycle Services
- 36** Summary | Configurations
- 38** Technical data

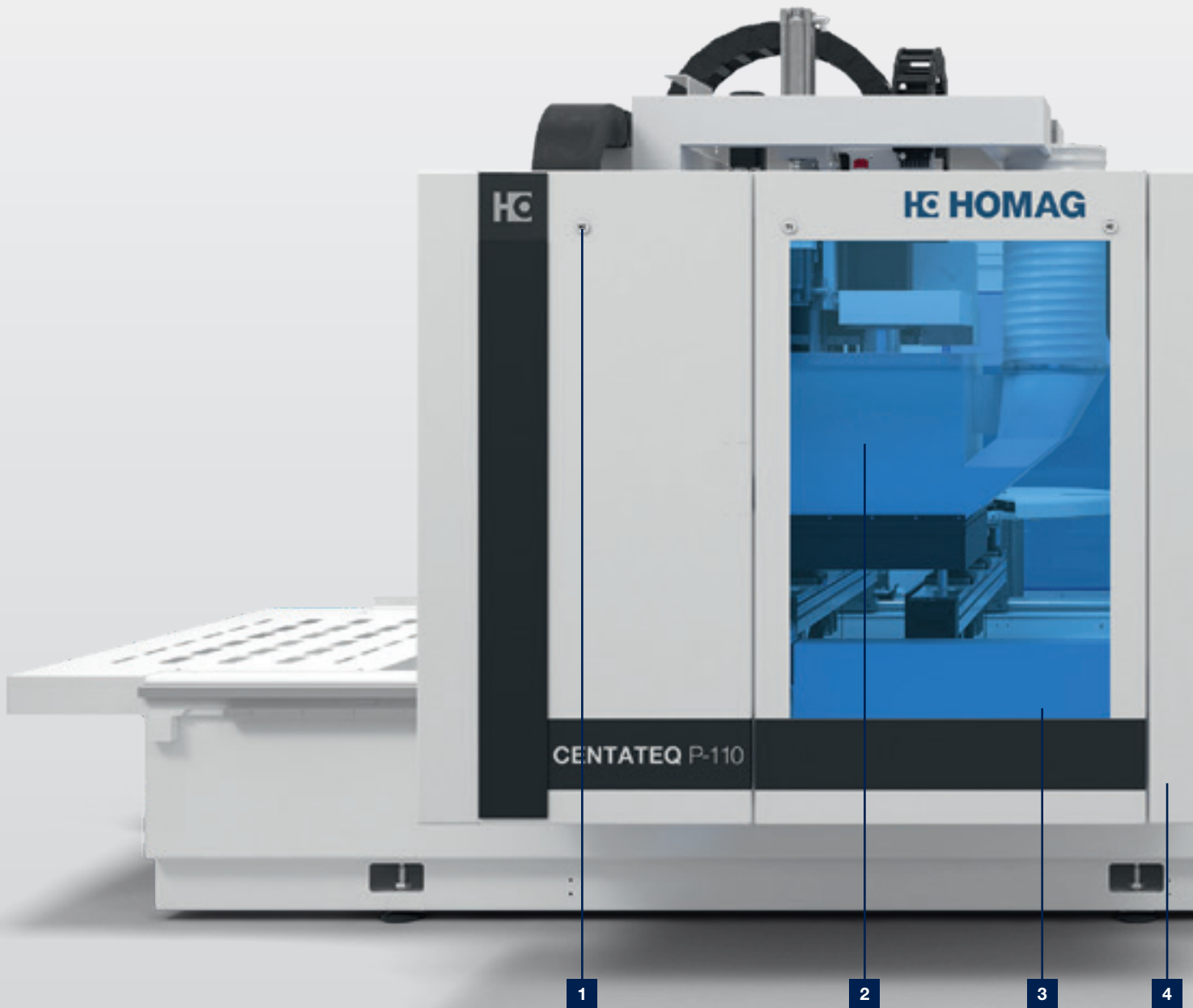

CENTATEQ P-110

- 3-axis technology
- 4-axis technology
- 5-axis technology

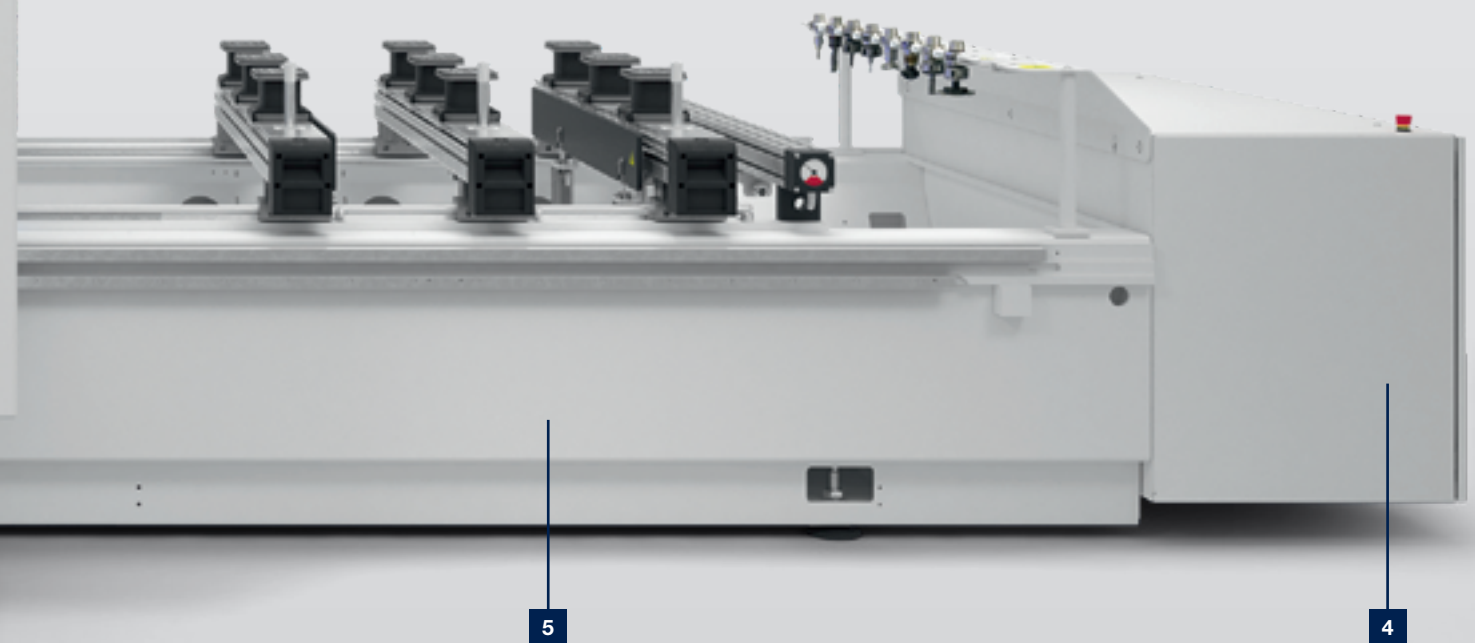

1 Convenience package (optional)
Operating functions can easily be activated via pressing a button directly at the machine. An integrated proximity scanner for intelligent pausing is included.

2 Aggregate technology...
3-, 4- and 5-axis equipments available. An all-rounder for ambitious users.

3 Everything under control...
Maximal insight into the machine and at the same time optimal protection of the operators by large windows.

4 360° more freedom...
Integrated switch cabinet, bumper technology and mobile control terminal provide a reduction of the footprint of up to 15% as well as free access from all sides.

5 Real heavyweight...
Heavy machine frame made of welded steel construction and solid carriage design ensure precise processing.

360° more freedom

Due to the compact design the installation space was reduced by up to 15%.
Additionally, free access to the machine from all sides.



- Switch cabinet integrated into machine
- Bumper safety technology instead of safety protection mats and protection grids
- Free positioning of mobile control terminal



- More efficient utilisation of space
- Variable installation opportunities
- Easy care and cleaning

Option: Convenience Package

Machine-related handling taken literally. Program start, pausing, relieving the working area and lifting the dust extraction hood can be directly effected by buttons at the gantry housing. This is supplemented by the laser scanner: If the operator is within the scanning zone, the machine is stopped without a program interruption caused by a bumper contact. Simple acknowledgement at the machine is sufficient for further operations.

- 1 Bumper safety technology**
Stop on contact with bumper, no disturbing protection mats, no protection mats required
- 2 Switch cabinet**
Integrated into machine
- 3 Laser scanner**
Mounted on the safety enclosure of the machine to monitor the working area. Stops the machine before contact with the bumpers and avoids program abort.

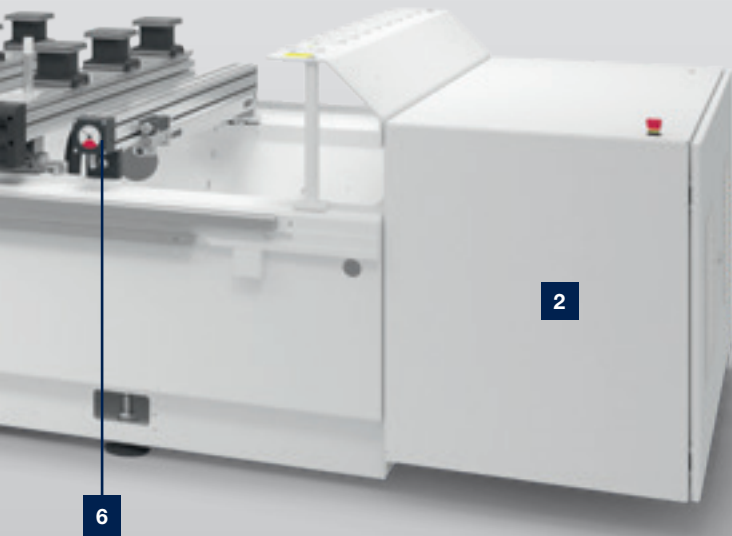

Start programme / relieve / pause programme



Raise/lower hood

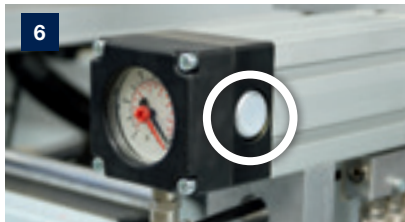

Button for program start Each one button at the left and right hand stop profile act as program start for the processing

Quality: today for tomorrow

HIGH STANDARDS: You require a suitable basis in order to provide highest performance. We rely on high-quality and proven components, so that you are perfectly equipped right from the beginning.



Linear guiding system Long-lasting linear guiding system with cover and plastic sealings. High-quality protection against dust and dirt. Provides sustainable exactness.



Chip transport (optional) Wide chip conveyor integrated in the machine frame for easy disposing of the chips and waste parts

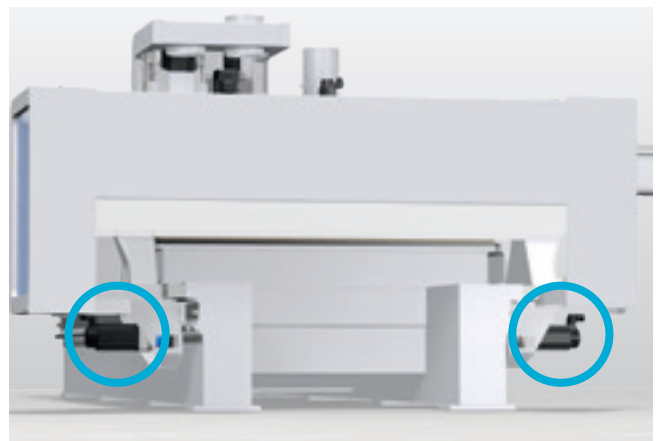

Synchronous drive 2 synchronised digital servo-drives in X-direction guarantee highest precision



UPS (uninterruptible power supply) (optional)

- Protects the computer against damage in case of mains interruption



Air-conditioning (optional)

- Air-conditioned switch cabinet



ecoPlus – energy saving function

- Simple activation of the stand-by mode
- Vacuum pump is switched off (savings of up to 12%)
- Reduction of compressed air (savings of up to 6%)

Whatever you want

Deciding in favour of a HOMAG machine means investing in a highly efficient processing center with the capability to fulfil wide-ranging different manufacturing requirements. Each machine is a complete system guaranteeing maximum output and efficiency every time – no matter how individual your production requirements are.

3- and 4-axis applications

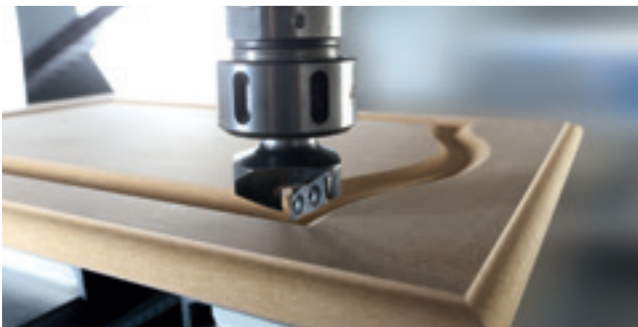

Profiling furniture fronts



Routing lock cases



Cutting mitre cuts



Cutting recesses for connecting fittings

5-axis applications



Mitre cut with high cutting depth for frames

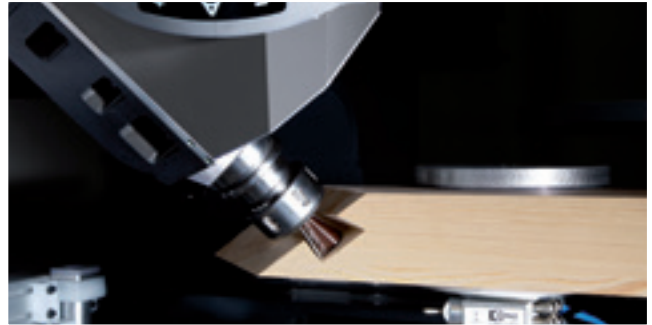

Routing of a dovetail joint for upright / transom constructions



Chamfer trimming on a table top



Square corner routing for a glass rebate

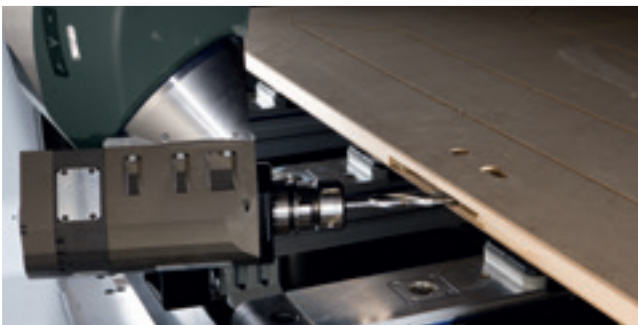

Lock case routing

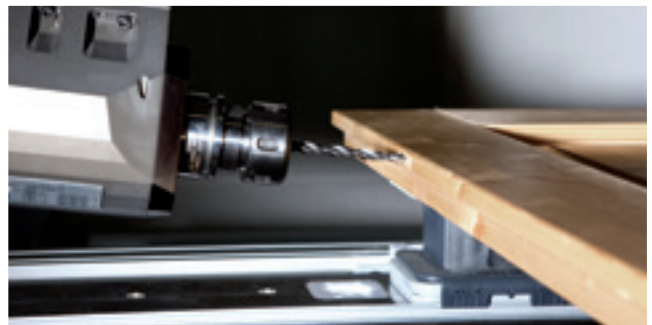

Step drilling for drill-in hinges



Precise, splinter-free miter cuts



Holes for piling at narrow angles

HOMAG drilling technology: The best of the best

High-speed drilling technology, patented clamping of the spindle and quick-change system for tools. Precise drilling, fast cycles, maintenance-free and durable construction.

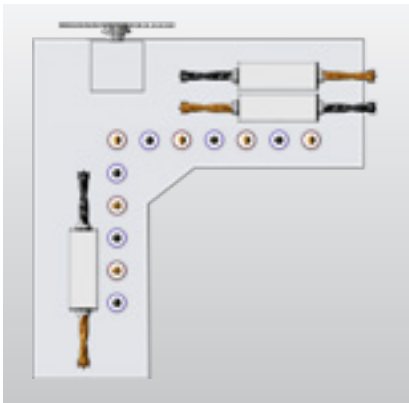

Drilling gear V12/H4X2Y

[3-/4-axis | 1 Z-axis]

- 18 drilling spindles [High-Speed 7500]
- 12 vertical drilling spindles
- 4 horizontal drilling spindles in X
- 2 horizontal drilling spindles in Y
- Grooving saw Ø 100 mm

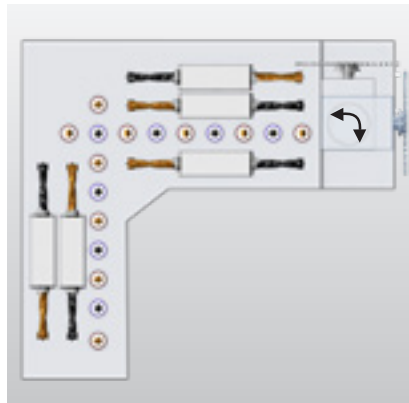

Drilling gear V17/H6X4Y

[3-/4-axis | 1 Z-axis]

- 27 drilling spindles [High-Speed 7500]
- 17 vertical drilling spindles
- 6 horizontal drilling spindles in X
- 4 horizontal drilling spindles in Y
- Grooving saw Ø 125 mm (0° / 90°)

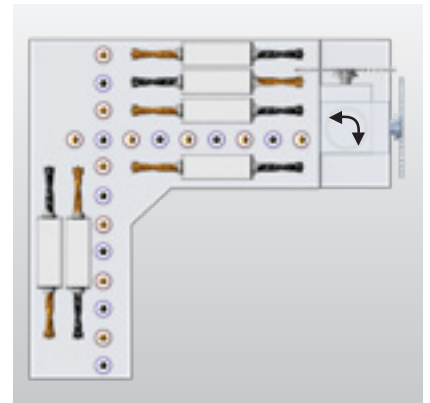

Drilling gear V21/H8X4

[3-/4-axis | 1 Z-axis]

- 33 drilling spindles [High-Speed 7500]
- 21 vertical drilling spindles
- 8 horizontal drilling spindles in X
- 4 horizontal drilling spindles in Y
- Grooving saw Ø 125 mm (0° / 90°)

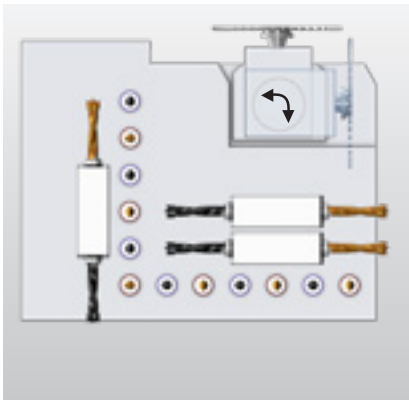

Drilling gear V12/H4X2Y

[3-/4-/5-axis | 2 Z-axes]

- 18 drilling spindles [High-Speed 7500]
- 12 vertical drilling spindles
- 4 horizontal drilling spindles in X
- 2 horizontal drilling spindles in Y
- Grooving saw Ø 125 mm (0° / 90°)

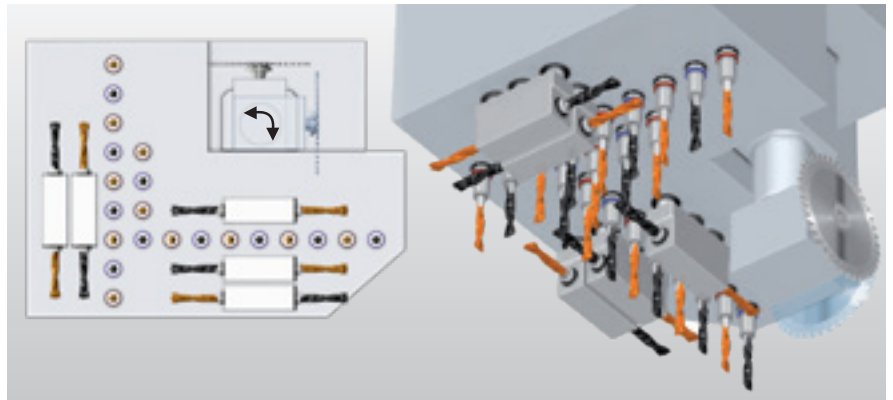

Drilling gear V21/H6X4Y

[3-/4-/5-axis | 2 Z-axes]

- 31 drilling spindles [High-Speed 7500]
- 21 vertical drilling spindles
- 6 horizontal drilling spindles in X
- 4 horizontal drilling spindles in Y
- Grooving saw Ø 125 mm (0° / 90°)

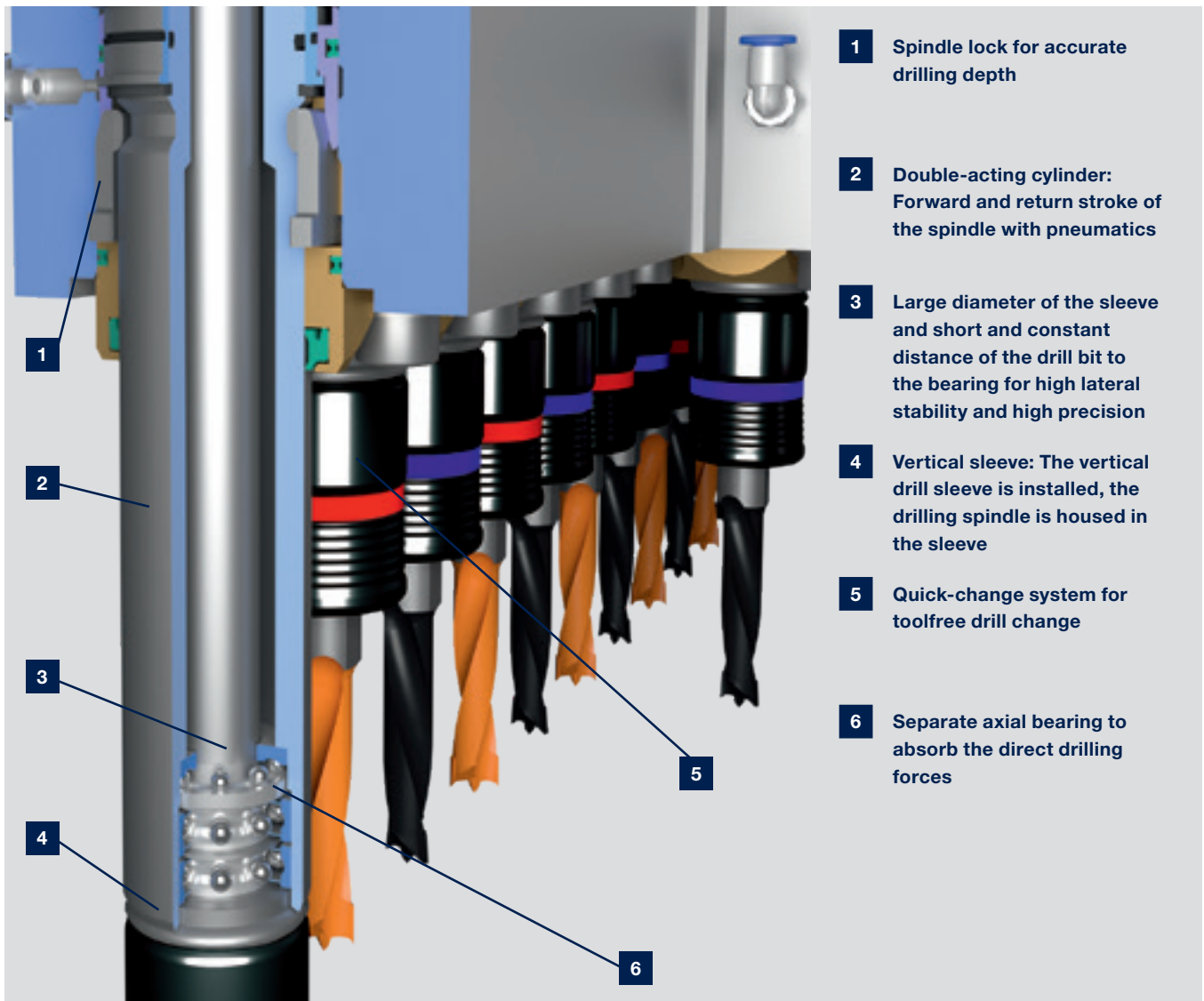

- 1** Spindle lock for accurate drilling depth
- 2** Double-acting cylinder: Forward and return stroke of the spindle with pneumatics
- 3** Large diameter of the sleeve and short and constant distance of the drill bit to the bearing for high lateral stability and high precision
- 4** Vertical sleeve: The vertical drill sleeve is installed, the drilling spindle is housed in the sleeve
- 5** Quick-change system for toolfree drill change
- 6** Separate axial bearing to absorb the direct drilling forces



Patented quick-change system for a drill change without tools to reduce setup times.

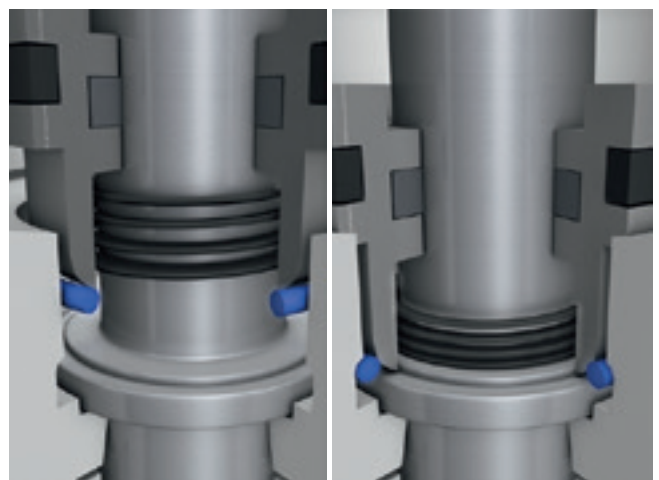

Automatic spindle lock – patented system for a drilling depth that is always accurate for numerous different materials. With speeds from 1500–7500 rpm for high feed speeds or short drill cycles.

Routing spindles: Solutions for all requirements

Connections fit to the future – Our interfaces feature patented technologies which allow to upgrade the operating spectrum of your plant. Unlimited production features are provided. Cutting, drilling, routing or processing with aggregates – it's your choice.

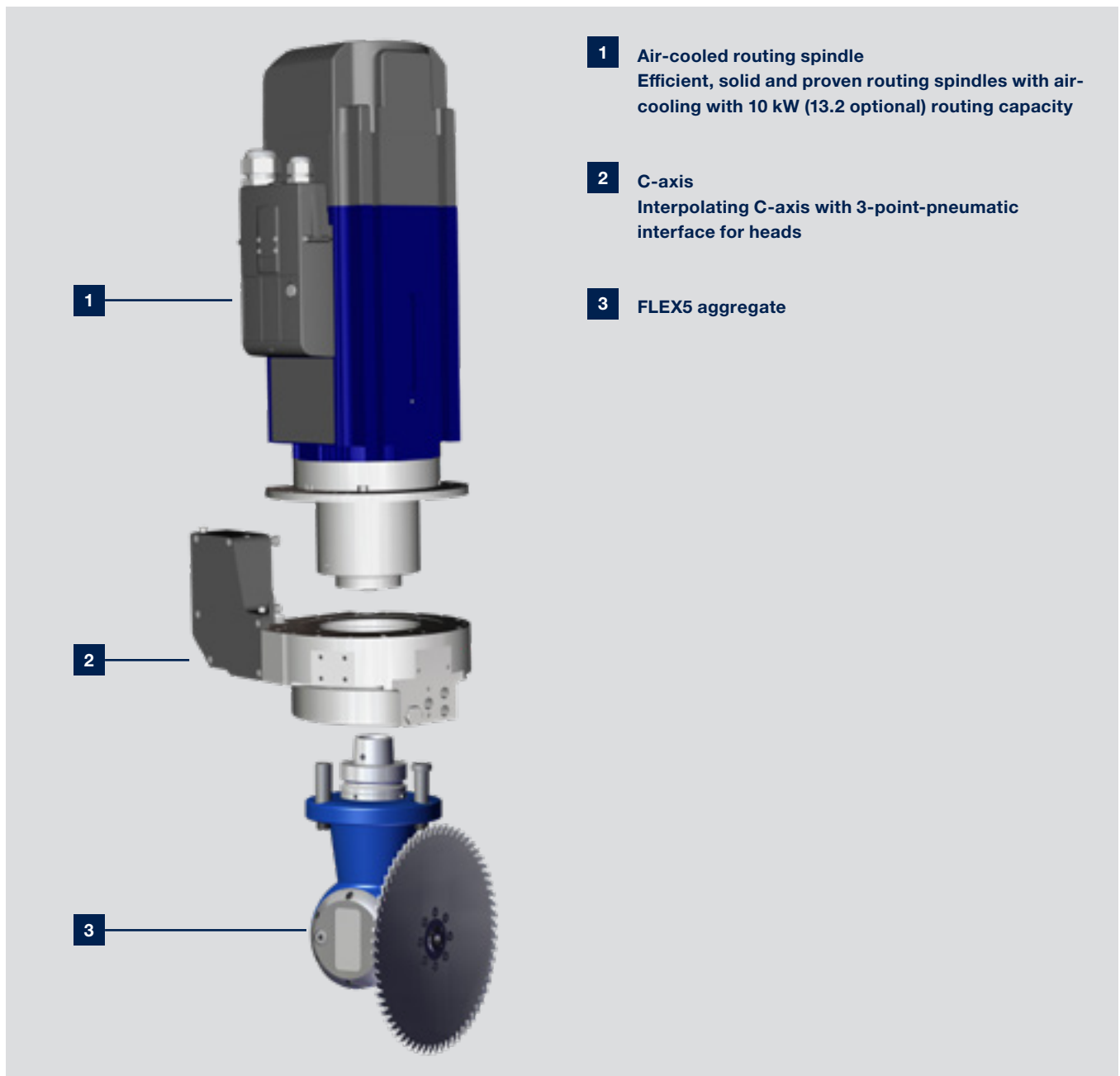

- 1** Air-cooled routing spindle
Efficient, solid and proven routing spindles with air-cooling with 10 kW (13.2 optional) routing capacity
- 2** C-axis
Interpolating C-axis with 3-point-pneumatic interface for heads
- 3** FLEX5 aggregate

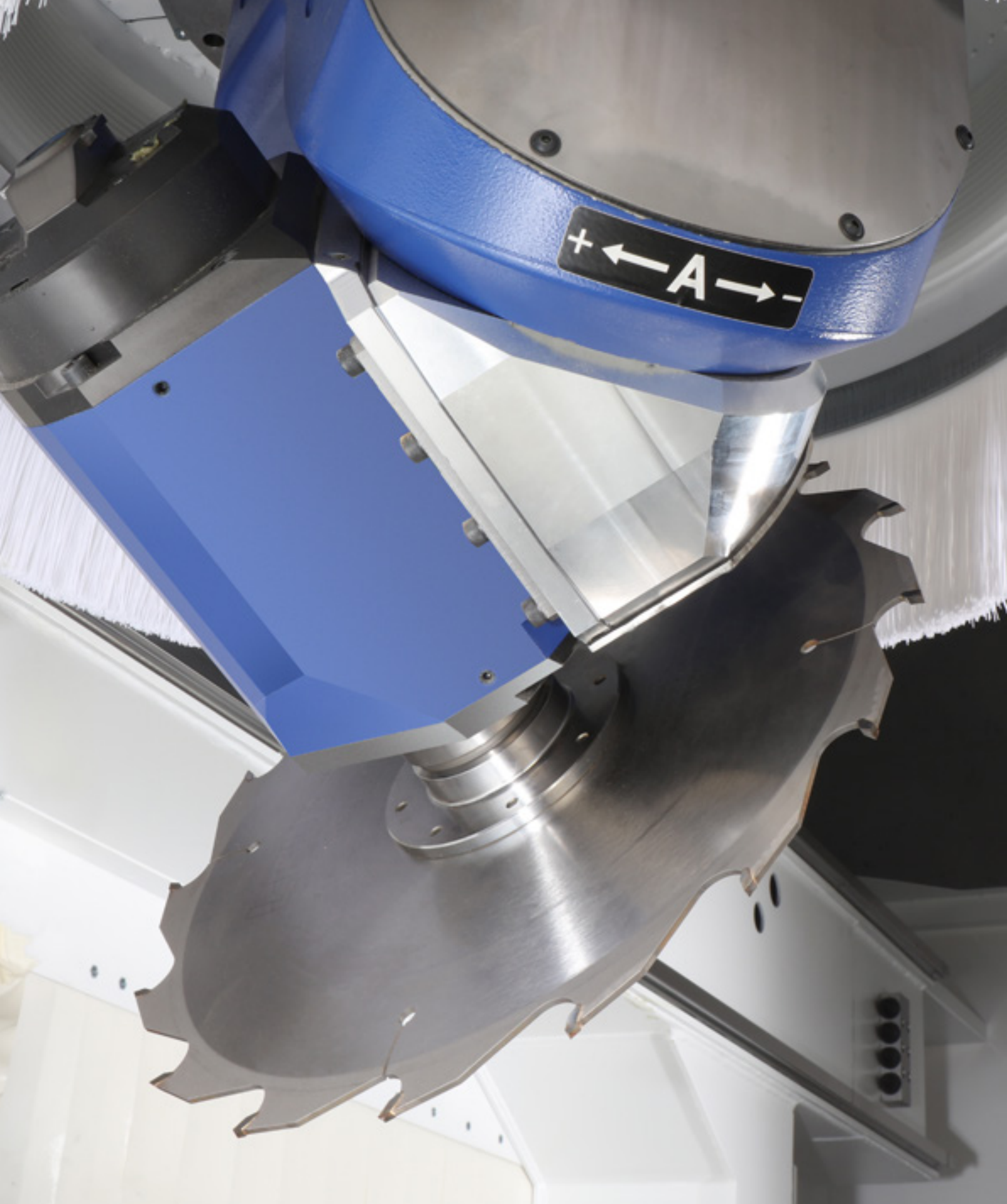

DRIVE5CS
.....

The smart DRIVE5CS 5-axis-head – compact design with short power transmission. Comprehensive technology on small space without limits regarding the processing range. Liquid-cooled spindle with 10 kW (as option 12 kW routing capacity) for efficient operations. The short design provides more space for processing (e.g. with a 350 mm saw blade).

Tool changer systems: Simple flexibility

All neatly stored away for quick access. Tool changers provide the basis for the flexible deployment of tools and units, also for large saw blades or heavy processing tools. Right from the beginning you get up to 24 tool changing places.



14-fold tool changer moving in X-direction

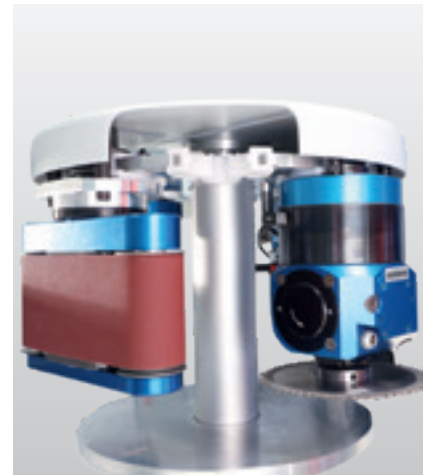

8-fold tool changer moving in X-direction





Linear changer

- Additional tool change magazine, with 10 slots and integrated tool transfer station, laterally mounted.
- One slot is prepared to accommodate a saw with a diameter of 350 mm.



Tool length control (optional)

- Suitable for length measurement of shank tools
- Following the tool change via the tool pick-up station a tool length control is carried out and compared with the integrated tool database



Tool pick-up station

- Safe and quick fitting of the tool change magazine
- High safety by sensor monitoring if the tool pick-up station is free or occupied

Options: Aggregates for 4-axis equipment

Range of modular units for flexible working

The aggregates required for the respective processing steps are fully automatically changed from the tool changing system into the main spindle of the machine. They can be swivelled from 0 to 360° over the C-axis. You get a great deal of flexibility and thus sufficient room to implement your own ideas. Always the optimal solution for your specific tasks.



High Performance
Planing*



Drilling/Sawing, swivelling*,
(0° - 90°)



High Performance
Drilling/Sawing/Routing*, 2 spindles



Drilling/Routing*,
4 spindles



Cam box router*,
2 spindles



Extension to FLEX5 (for 4-axis version)
Consisting of FLEX5 interface and FLEX5 head

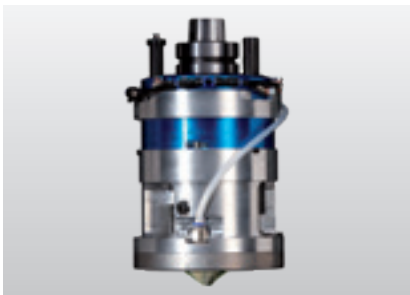

Tracing routing aggregate with tracing ring*

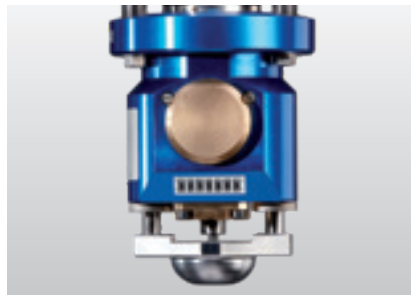

Cutting aggregate*

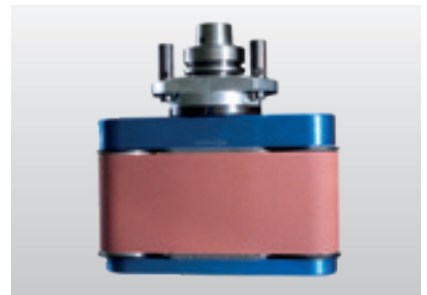

Belt sanding unit

* For maximum tool lengths and diameters see the respective technical data sheet



Many aggregates are optionally available as High Performance versions. This ensures optimum lubrication of gear components for prolonged operations.

Clean and fast: the console table

The classic table with single-circuit vacuum system.

The vacuum clamps are steplessly positioned and offer clearance for the use of tools and for dropping waste pieces.

As standard, the exact positioning is supported by measuring tapes. LED and laser positioning aids are provided for fast and easy positioning of suction cups.

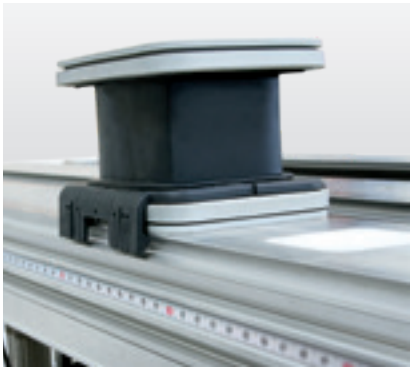

Measuring tape for positioning of suction cups

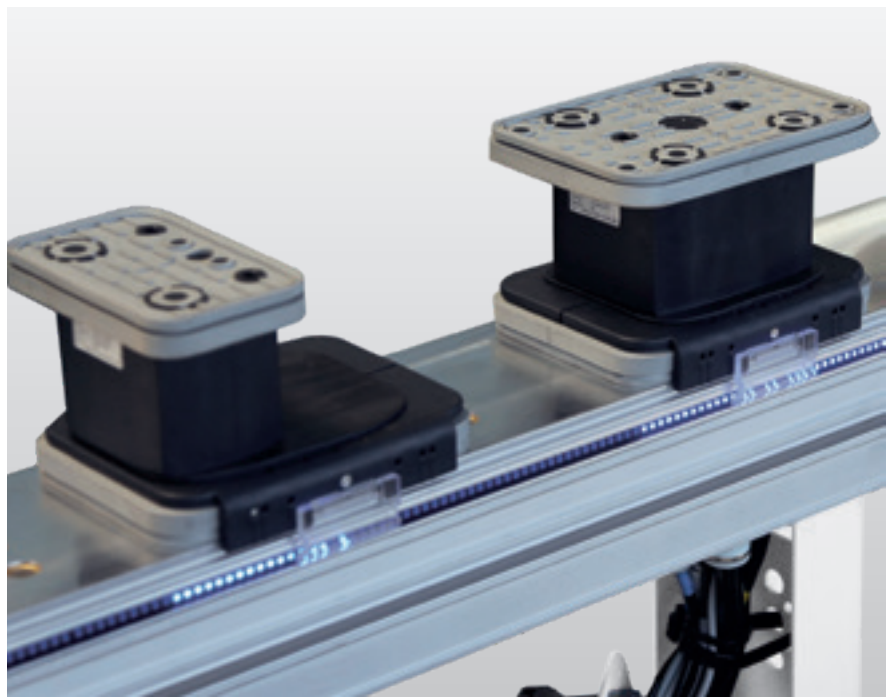

LED positioning system (optional) LED lights show the operator exactly the position, orientation and size of the suction cups as well as the position of the consoles → positioning faster by 70 %



Laser positioning (optional) Simple positioning of the vacuum cups through the pin laser. The workpiece contour can be "moved" as a positioning aid for free-formed workpieces.



Laser projection of the clamping equipment and the workpiece contour for optimal utilization and simple positioning of unprocessed parts that cannot be aligned on the stops.



Suction cup storage area Storage area laterally integrated into the machine for vacuum suction cups for easy and fast access

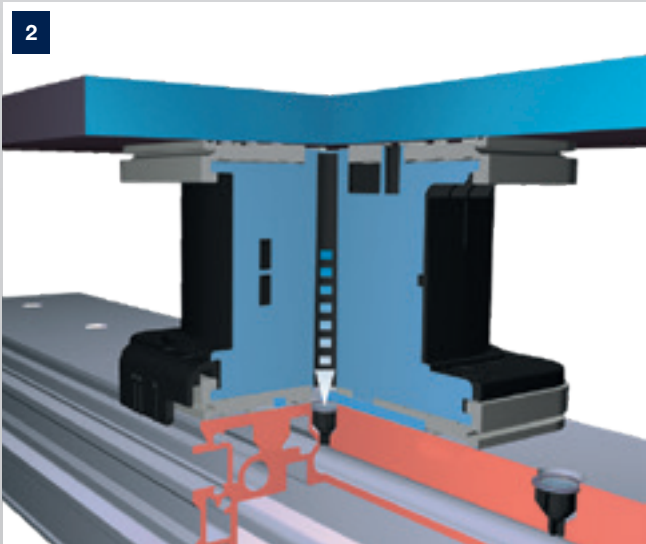

In the single-circuit vacuum system vacuum clamps are used with a height of 100 mm. The vacuum clamps the workpiece and clamp simultaneously. The lip technology of the rubber-coated surfaces on the vacuum clamps guarantees maximum force distribution. The double lip technology on the underside of the vacuum clamp allows stepless positioning on the consoles.

Accurate and safe with the console table

Thanks to the patented system of solenoid valves, vacuum suction units and other clamping equipment can be used in any number and in any location on the consoles. Application-optimized stops and insertion aids ensure precise placement and positioning of the components.

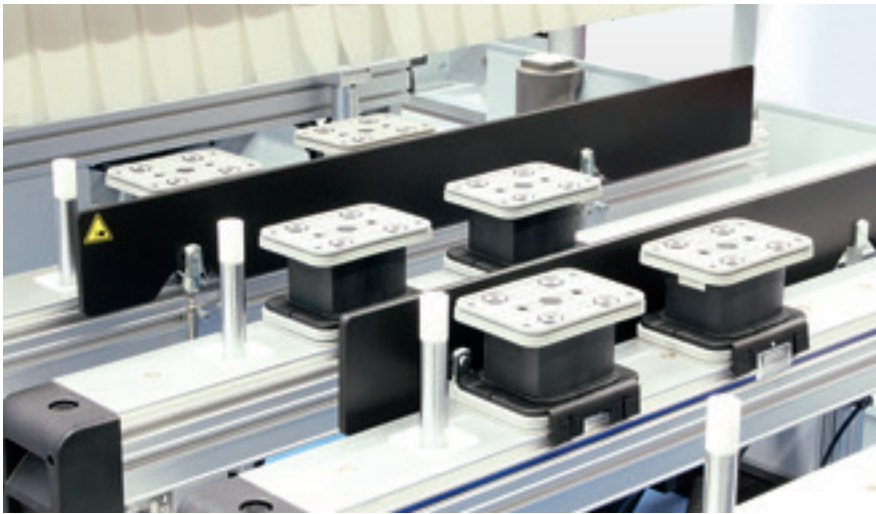

Workpiece feeding rail Solid feeding rails to ease placing of heavy workpieces with 2 pneumatic cylinders. The linear movement of the feeding rails ensures safe positioning of the workpieces, regardless of whether they are processing at the front or rear stops.

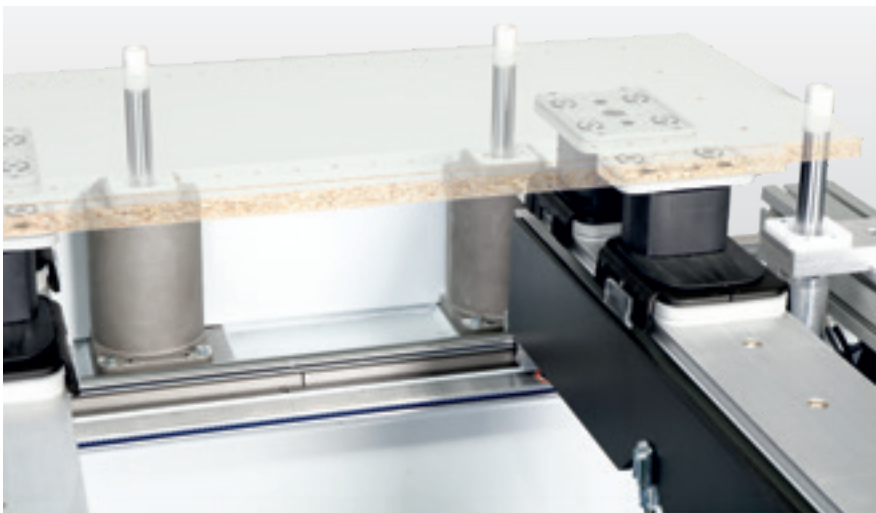

Stop system (rear, front and side) Solid stop bolts pneumatically lowerable and incl. electronic cylinder surveillance



Electronic cylinder surveillance Improved safety by electronic surveillance of all stop cylinders



Stops for coating ply overhang (optional) Ensures easy positioning in the case of coating ply overhang (e.g. veneer)

PowerClamp E.g. for processing of solid wood components on 6 sides (lowerable base plate)



Clamping device Uprights and staves can be securely clamped in no time using this clamping device

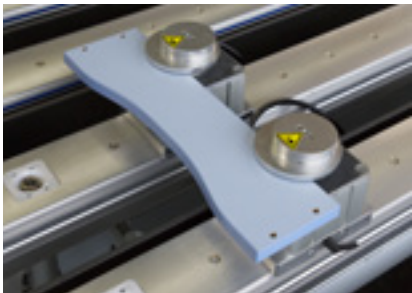
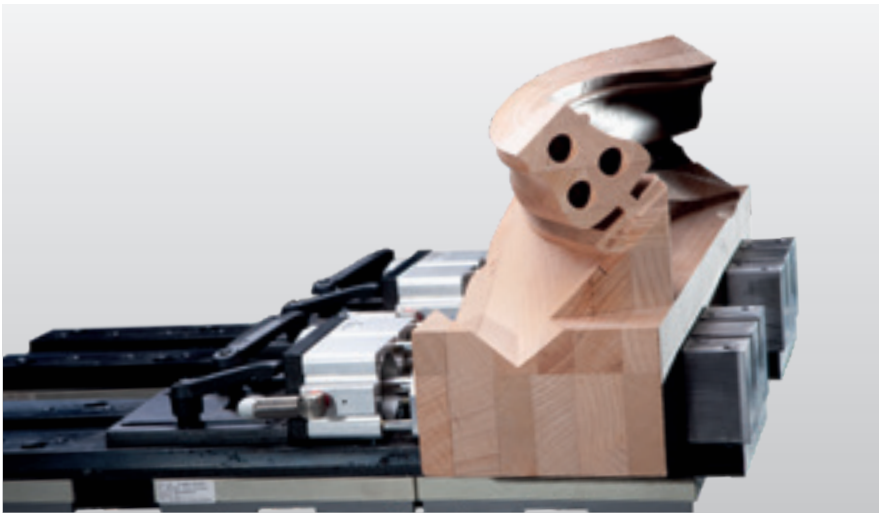

Multi clamping system E. g. for frames and small parts

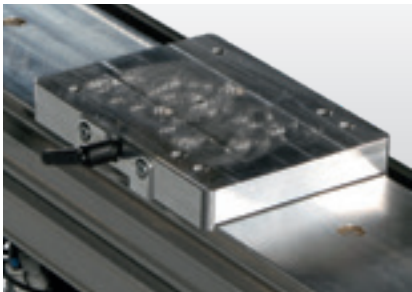
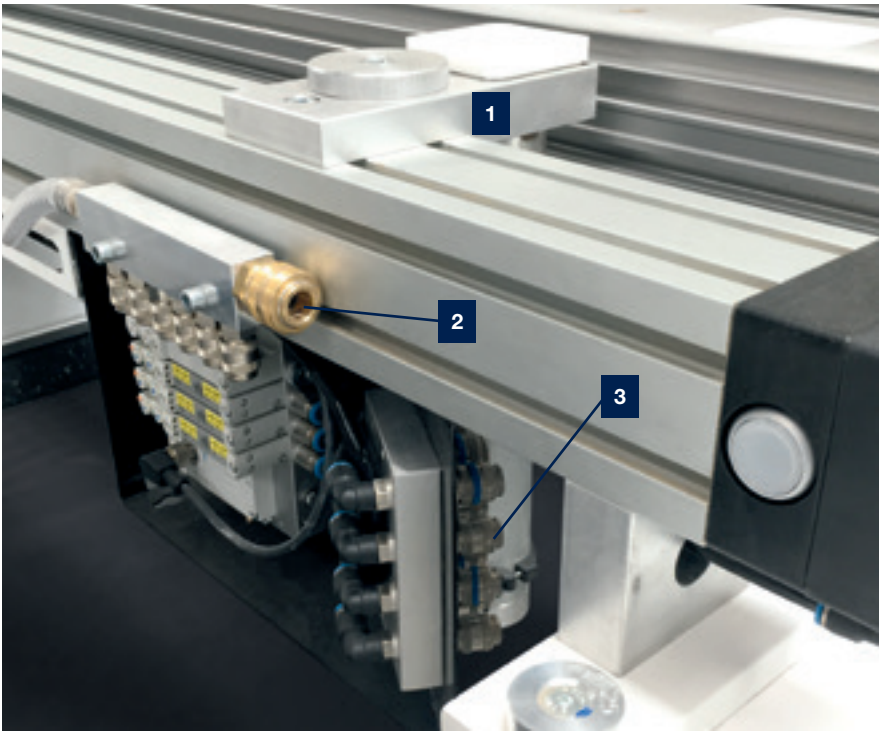

Base plate module for mounting on the consoles as the basis for special clamping fixtures.

- 1** Easy adjustment of the side stops
- 2** Vacuum connection for templates
- 3** Pneumatic connection with 2-pressure control for 2 clamping rows (optional)



1" vacuum connections with quick-open function by means of switch cabinet key, vacuum openings with precision thread for fixing clamps



Slot nuts with thread for positive locking of clamping fixtures in the dovetail guide.

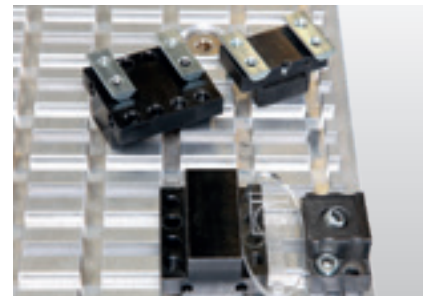

Aluminium matrix table with trapeze shaped grooves for interlocking and flexible fixing of all kinds of clamping aids

Versatile application: the matrix table

The grooved aluminium matrix table permits the positive locking of clamping elements and consequently reliable workpiece fixture even where high hogging forces are involved. The transmission of vacuum through the table construction optimizes distribution of the vacuum, reduces

leaks and transmission losses and does away with the need for complex installations. The matrix table is also suitable for aggregates due to different clamping elements with variable mounting heights.



Laser positioning Routing contours can be processed via the cross-laser

The Matrix table – for Nesting and many other applications

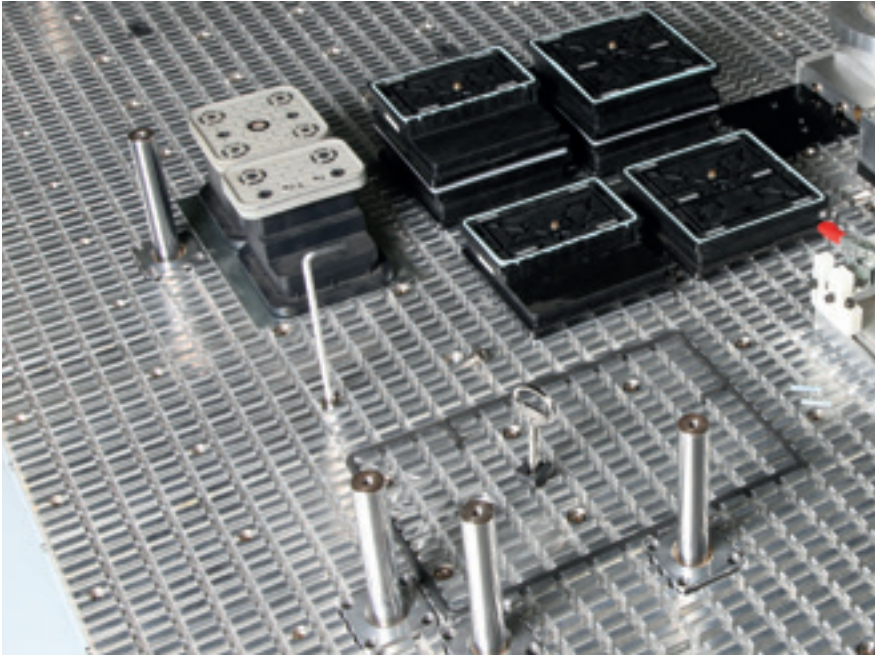

Vacuum clamp Vacuum clamping elements for insertion in the grooves of the Matrix table

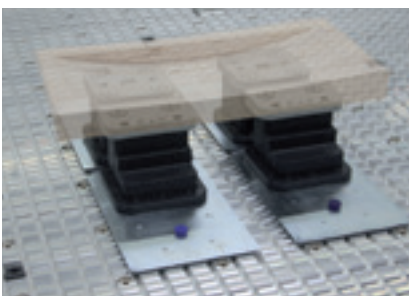
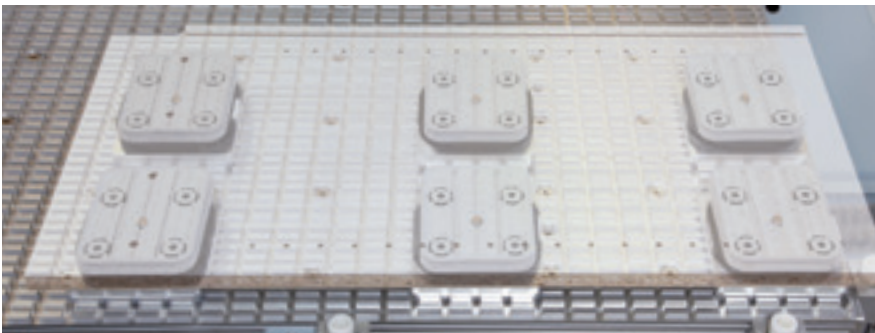
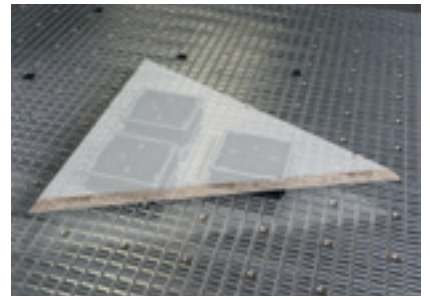

Maxi-Flex system Freely mountable system base plate for vacuum clamp.

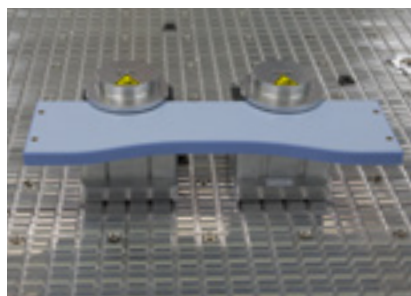

Multi-clamp Vacuum-actuated clamping element for clamping strips and elements.



Fixture using non-standard clamps The aluminium Matrix table with dovetail guides guarantees precise, positive fitting clamping element fixture.

With diverse types of vacuum blocks with different heights it is possible to carry out simple and quick horizontal processing on Matrix tables, e.g. for doors. And when processing technical components and moulded parts, it is also possible to partly dispense with clamping templates.

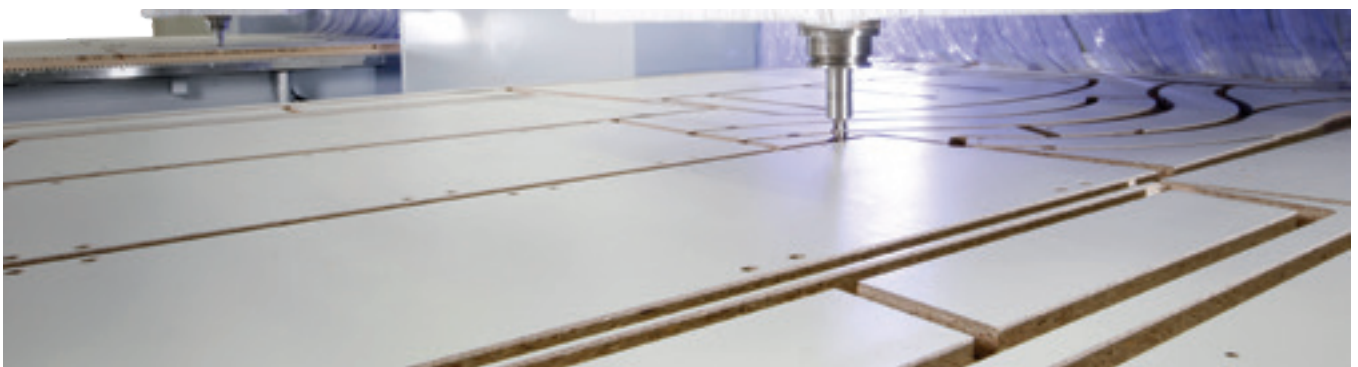
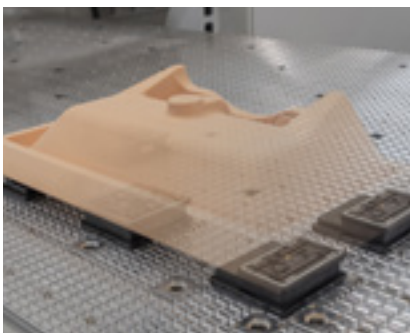
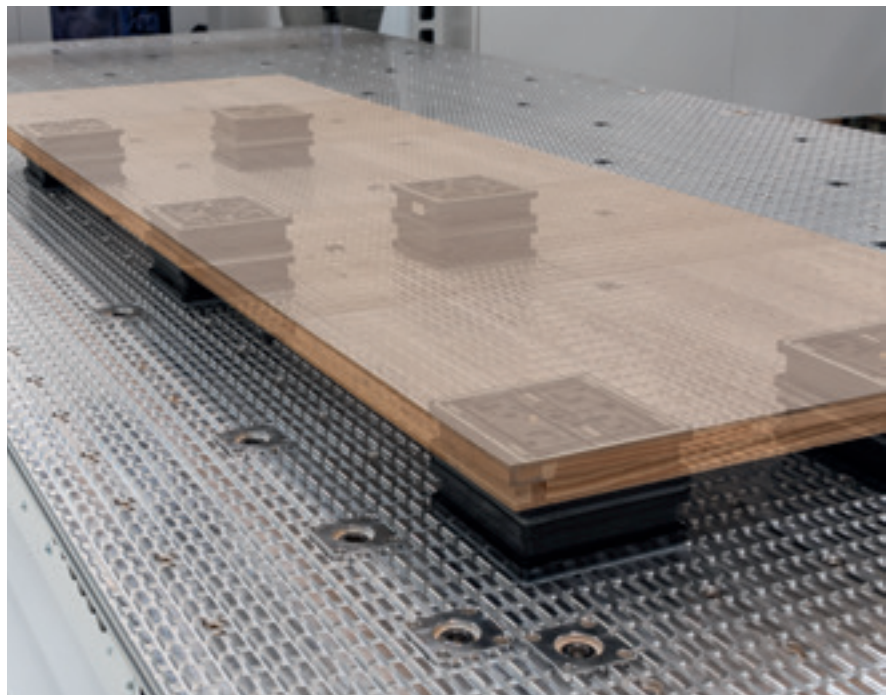
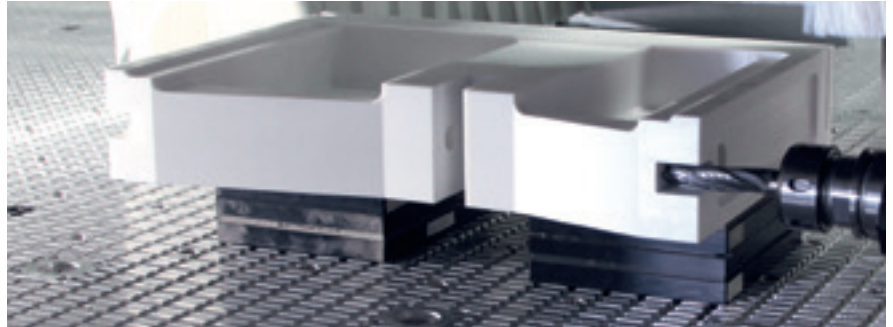

Nesting processing of panel materials: waste-optimized cutting to size and processing in the surface

HOMAG software solutions: The basis for simple and efficient operation

Our processing centers are one thing – the software to operate them conveniently and easily day-to-day is another. HOMAG software and control modules ensure maximum flexibility and operational safety. Naturally with HOMAG:

Interfaces to external programming and construction systems, auxiliary programs for nesting and modules for machine monitoring and performance tracking.

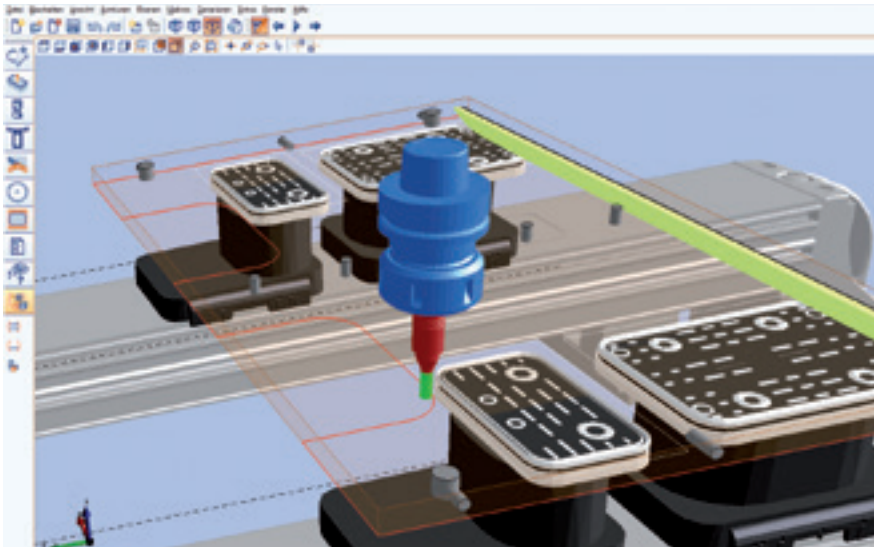

**Please use our website!
Worldwide largest
forum for
woodWOP:
forum.homag.com**

 A white icon on a dark blue background. It depicts a smartphone with a magnifying glass over the screen, symbolizing search or access to information.

woodWOP – efficient thanks to fast programming

- Fast and intuitive operation thanks to simple, direct navigation
- Select from a choice of variables for flexible variable programming
- Quickly create individual subprograms
- Increased programming security through 3D images of workpieces, processing and clamping equipment.

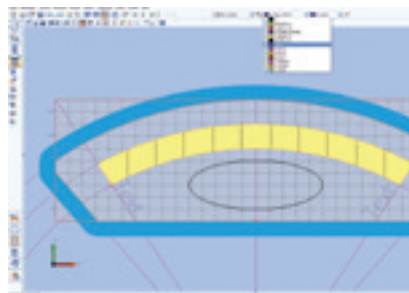

woodWOP CAD-Plugin

- CAD functions integrated directly into woodWOP
- Creation of your own CAD drawings on the machine and the work preparation station
- Import of CAD objects in the formats DXF, IGS, STP, STL

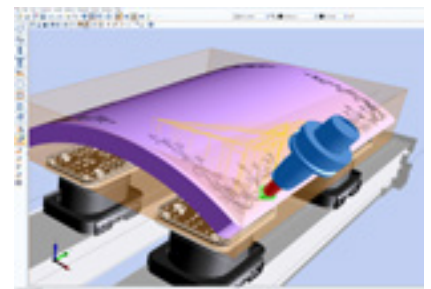

woodWOP CAM-Plugin

- Rapid construction of 3D surfaces in the CAD plugin or by importing 3D models
- Automatic generation of the milling paths for roughing, finishing and formatting 3D objects
- Safe work, because the milling paths and the overrun movements are displayed graphically and simulated in woodWOP



powerControl with powerTouch2

- Full-HD multitouch display with wide screen 16:9
- Provision teleservice capability
- USB frontside bus
- Ethernet connection 10/100 Mbit
- Ergonomic hand terminal
- Position of the switch cabinet »freely selectable« (left/right)



woodScout – help in your language

- Optional powerful diagnostic system
- Graphic display of the malfunction location on the machine
- Clear plain-text error messages in different languages
- Adaptive system through the allocation of causes and measures

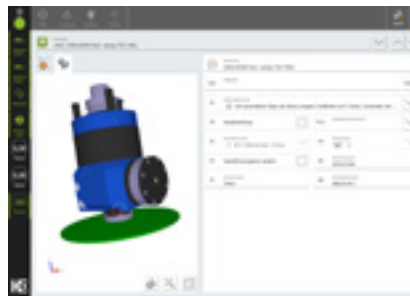

Graphic tool data base

- Record quantities and actual operating times on the machine
- 3D representation of the tools and units
- Graphic setup of the tool changer using drag & drop



Machine data acquisition MMR Basic

- Record quantities and actual operating times on the machine
- Integrated maintenance instructions for optimum time and quantity-based planning, as well as performing maintenance

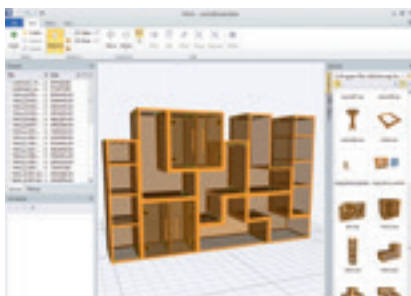

woodAssembler

- To visualize woodWOP-programs (MPR) in 3D
- Enables the construction of individual workpieces to finished objects

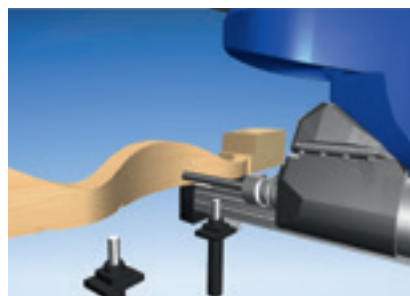

3D CNC-Simulator

- Simulates the processing acc. to the order set in the NC program
- Allows time calculation
- Collision check of the vacuum cups



woodWOP DXF Basic

- Interface for CAD-Data import
- Automatic generation of woodWOP programs on the basis of CAD drawings

The next generation of powerTouch: **powerTouch2**

Faster, more comfortable, clearer: Enjoy the benefits of our further improved powerTouch user interface. We have optimized our standardized operating concept and further adapted it to our customers' requirements.

Controlling your HOMAG machines is now even faster and more intuitive. The new, modern design has a clear structure. The innovative touch operation allows you to achieve the desired result easily and comfortably.



Our successful powerTouch philosophy – **standardized, simple, ergonomic, evolutionary** – consistently further developed



Clearer structure

The structure of the powerTouch2 screen is even clearer. You only see the information that is relevant for you. The important points at a glance – but you still have all the details. All in a fresh, attractive design.



Even faster

With the new powerTouch generation, you can enter information at your machine even more quickly. Compared to the previous version, you can achieve a time saving of up to 30%. This is possible thanks to new features, such as automatic word completion, a pop-up keyboard that can be kept open and Windows-like functions, such as the selection of common actions directly via the start button.

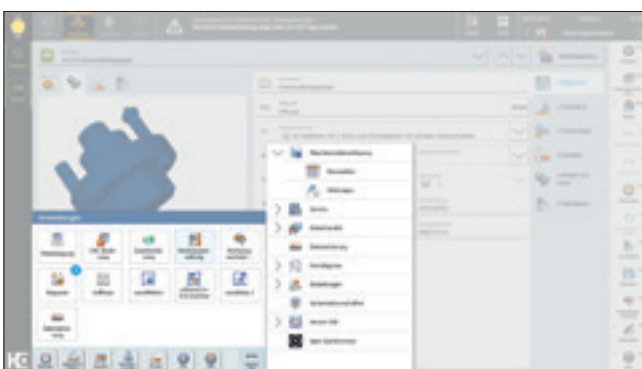

More comfortable

We have also improved the traffic light dialog and the „Start“ menu. When you press and hold the program icon, not only are the possible actions displayed, you can also access and activate them directly. Operation is therefore immediate and you do not lose any time opening applications. What's more, for the applications, illustrations and additional information can be displayed instead of simple program icons. This also provides more transparency and avoids unnecessary navigation into applications.



More intuitive

Operating the machine is child's play. Many of the functions are similar to those of a smartphone or tablet and will therefore be familiar to you. Even beginners will feel immediately at ease and will soon be able to control the machine comfortably.

Easy to get. And easy to use.

tapio is the open wood industry ecosystem

This means that everyone involved in the wood industry can participate.
Because together with our business partners, we develop digital solutions for everyone.



Just have a try:

Free use of the MachineBoard app! Just register under tapio and “connect” the machine www.tapio.one. The complimentary usage is limited in time.

Apps that make working life easier.

tapio

Partner

DataSave

- Protects machine and configuration expertise
- Faster service for machine breakdowns
- Saves time when restarting production
- Saves on maintenance costs
- Automatic backups of several machines

ServiceBoard

- Create service cases quickly and easily and send them to the correct service partner
- Live video diagnostics to solve service cases with image support
- Video reduces the language and distance barriers
- Also works without a machine connection to tapio (and is therefore ideal for older machines)

MachineBoard

- Push notifications
- Machine data and status can be viewed from anywhere in real time
- Lists of errors, warnings, maintenance tasks and actions
- Displays the remaining time until the next intervention by the machine operator



Free demo for all tapio apps, no registration required. Simply download and test.

Currently available in the EU and Switzerland.

(Due to the fast pace of the IT-landscape, the compatibility to the tapio platform is warranted for five years.)

HC LIFE CYCLE SERVICES

Optimal service and individual consultations are included in the purchase of our machines. We support you with service innovations and products which are especially tailored to your requirements. With short response times and fast

customer solutions we guarantee consistently high availability and economical production – over the entire life cycle of your machine.



REMOTE SERVICE

- Hotline support via remote diagnosis by our trained experts regarding control, mechanics and process technology. Thus, more than 90% less on-site service required and consequently a faster solution for you!
- The ServiceBoard App helps to solve tasks in a fast, simple and concrete way. This is achieved by mobile live video diagnosis, automatic sending of service requests or the online spare parts catalog eParts.



SPARE PARTS SERVICE

- High spare parts availability and fast delivery.
- Ensuring quality by predefined spare parts and wear parts kits, comprising original spare parts.
- Identify and inquire for spare parts online under www.eParts.de 24/7, or buy even faster and more comfortably in the new HOMAG Webshop eCommerce.



MODERNIZATION

- Keep your machinery up to date and increase your productivity as well as your product quality, This is how you can meet tomorrow's requirements today!
- We support you with upgrades, modernization as well as individual consultancy and developments.



DIGITAL SERVICES

- ISN (intelliServiceNet) – The new remote service solution of the future! Fast restart of production because the remote service employee has extensive access to relevant physical data.
- intelliAdvice App – provides help for self-help. The preventive solutions proposed in the new App are the combination of our experiences and existing machine data.



SOFTWARE

- Telephone support and consultancy through software support.
- Digitalization of your spare parts via 3D scanning saves time and money compared to new programming.
- Subsequent networking of your machinery with intelligent software solutions ranging from construction to production.



FIELD SERVICE

- Increased machine availability and product quality by certified service staff.
- Regular checks through maintenance / inspection guarantee the highest quality of your products.
- We offer you the highest availability of technicians in order to reduce downtimes in case of unpredictable troubles.



TRAINING

- Thanks to training perfectly suited to your requirements, your machine operators can optimally operate and maintain the HOMAG machines.
- The training also include customer-specific training documents with exercises proven in practice.
- Online training and webinars. Learn without traveling, meet your trainer in the digital classroom.

For you more than...

1,350

service employees worldwide

90 %

less on-site service thanks to
successful remote diagnosis

5,000



customer training sessions per / year

150,000

machines, all electronically documented
in 28 different languages – in eParts



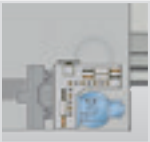



Summary: Configurations

It's your choice. One package available for all current demands. Thus, all requirements are fulfilled.

		Spindle	C-axis	Interface FLEX5	8-fold tool changer Moving in X
3-/4-axis (1 Z-axis) 	Basic	Air-cooled 10 kW / 13,2 kW	<input type="radio"/>	<input type="radio"/>	✓
	Future		<input type="radio"/>	<input type="radio"/>	
	Performance		<input type="radio"/>	<input type="radio"/>	
3-/4-axis (2 Z-axes) 	Basic	Air-cooled 10 kW / 13,2 kW	<input type="radio"/>	<input type="radio"/>	✓
	Future		<input type="radio"/>	<input type="radio"/>	
	Performance		<input type="radio"/>	<input type="radio"/>	
5-axis (2 Z-axes) 	Basic	DRIVE5CS Liquid-cooled 10 kW / 12 kW			✓
	Future				
	Performance				

- Basic** Universal basic configuration for furniture components and structural elements.
- Future** Increased performance in panel processing thanks to more drilling spindles.
- Performance** Fast drilling and universal application with high tool variation.



Tool changer		Drilling gear				
14-fold tool changer	10-fold linear changer	Drilling [7500 High-Speed]			Grooving	
						
Moving in X		vertical	horizontal in X	horizontal in Y	Ø mm	S0/90°
	✓	12	4	2	100	
✓	✓	17	6	4	125	✓
✓	✓	21	8	4	125	✓
	✓	12	4	2	125	✓
✓	✓	12	4	2	125	✓
✓	✓	21	6	4	125	✓
	✓	12	4	2	125	✓
✓	✓	12	4	2	125	✓
✓	✓	21	6	4	125	✓

Standard: ✓

Option: ○

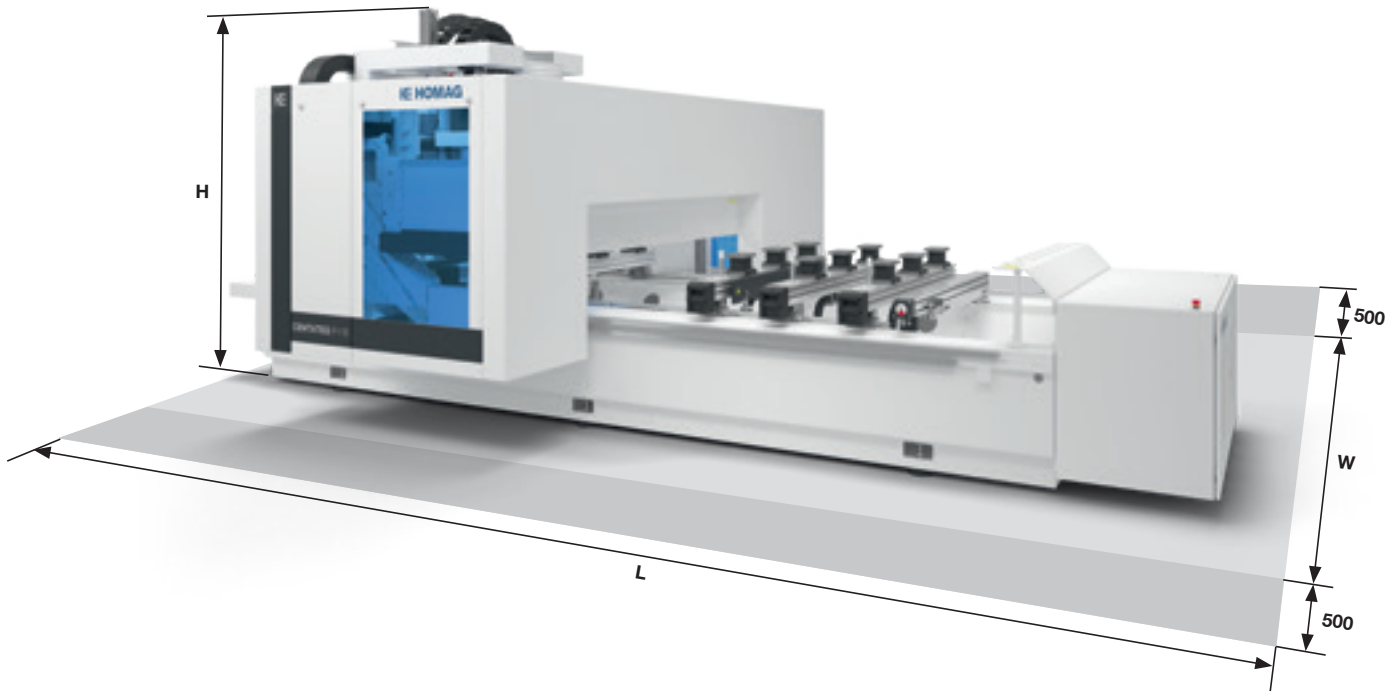

WORKING DIMENSIONS

Y = Workpiece width [mm/inch]	A = 0° with tool diameter 25 mm		A = 90° with tool length 200 mm / with all aggregates	
	Rear stop		Rear stop	
1 Z-axis	1,550 / 61.0		1,440 / 56.7	
2 Z-axes	1,415 / 55.7		1,210 / 47.6	

X = Workpiece length [mm/inch]	A = 90° with tool length 195 mm / with all aggregates		
	Individual processing	Alternating processing	
/31	3,100 / 122.0	1,025 / 40.4	
/42	4,200 / 165.4	1,575 / 62.0	

Z = Workpiece thickness [mm/inch]	from console
	260 / 10,2

INSTALLATION DIMENSIONS

Machine type		Installation length [mm/inch]	Installation depth [mm/inch]		Installation height [mm/inch]
			L	W with 8-fold tool changer	
1 Z-axis	/31	6,850 / 269.7	3,171 / 124.9	3,616 / 142.4	2,400 / 94.5
	/42	7,950 / 313.0	3,171 / 124.9	3,616 / 142.4	2,400 / 94.5
2 Z-axes	/31	6,850 / 269.7	3,616 / 142.4	3,616 / 142.4	2,650 / 104.3
	/42	7,950 / 313.0	3,616 / 142.4	3,616 / 142.4	2,650 / 104.3

1 Z-AXIS | CONSOLE TABLE

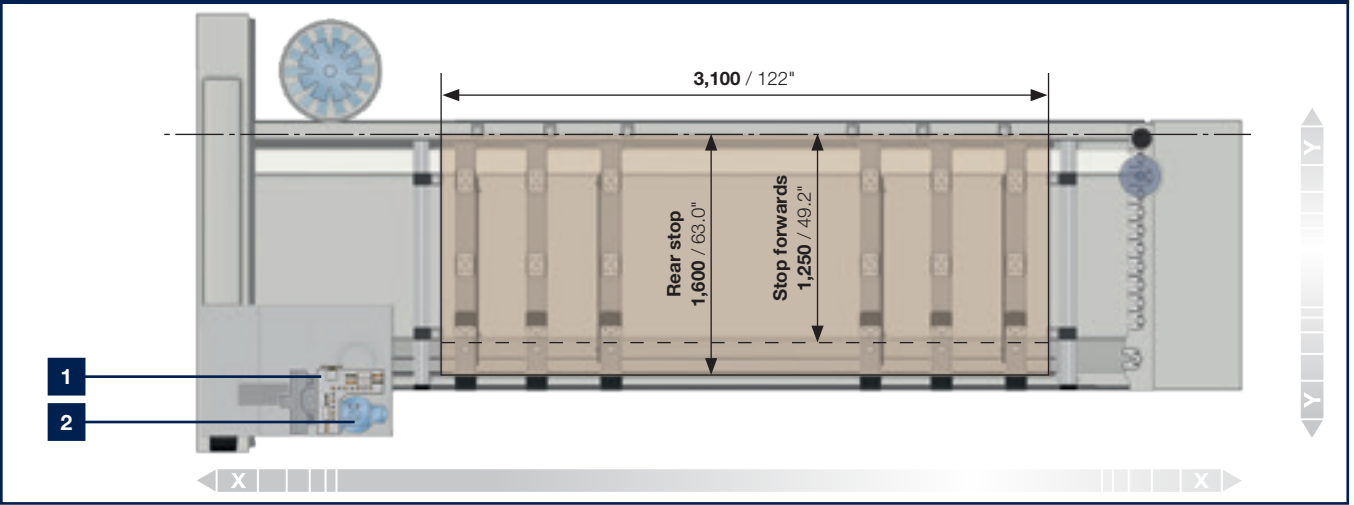

2 Z-AXES | CONSOLE TABLE

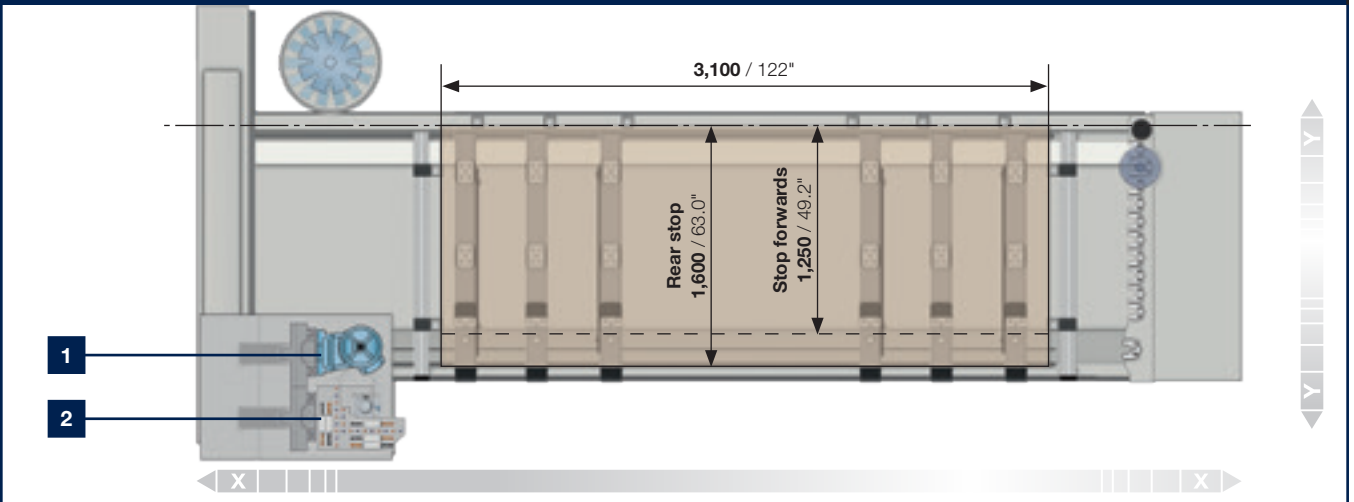

2 Z-AXES | MATRIX TABLE

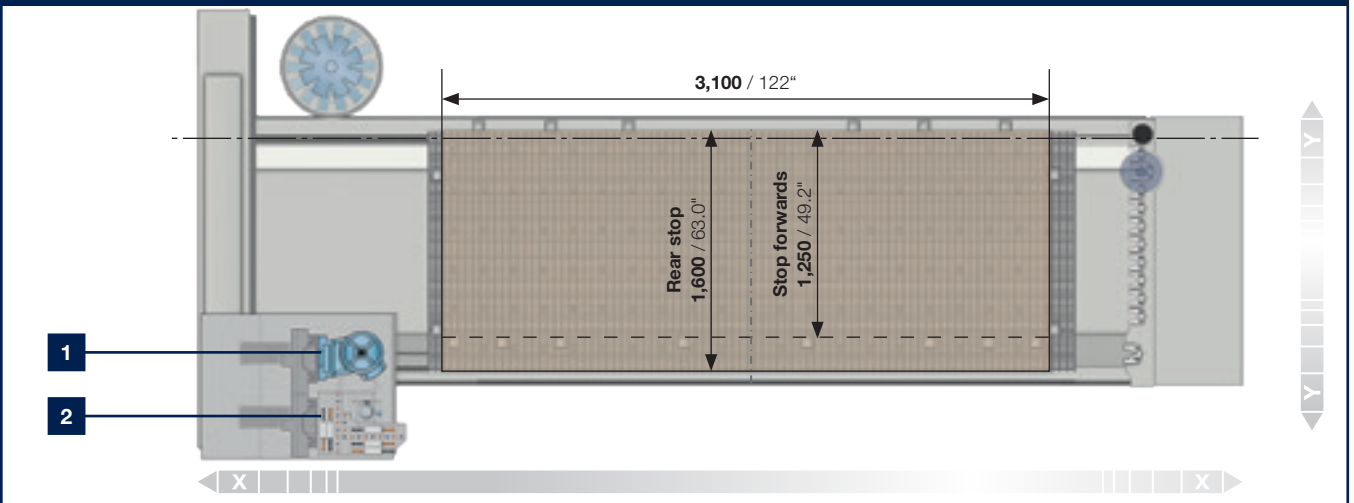

1 Routing spindle

2 Drilling gear

mm / inch

HOMAG Group AG

info@homag.com

www.homag.com



YOUR SOLUTION