

Processing Centers

# Venture 21/23

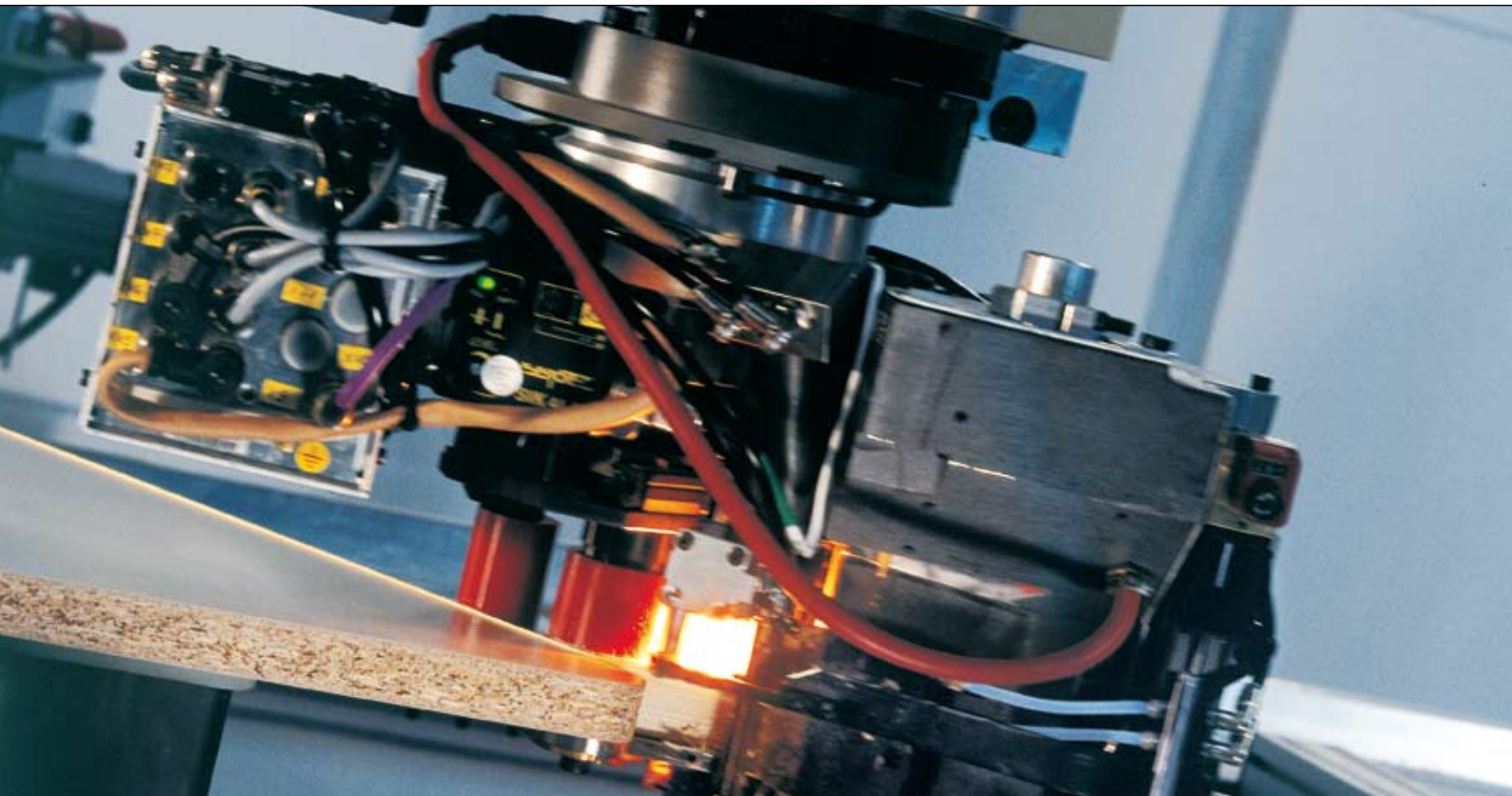



## Venture 21 and Venture 23 –

Alongside versatile routing functions, the compact Venture 21 and Venture 23 processing centers offer a range of unique additional functions:

- Edge banding with exchangeable gluing units (patented)
- FLEX5 unit with automatic angle setting (patented) for trimming and drilling, e.g. for shift cuts.  
As FLEX5+ also with automatic tool change
- Entry into nesting technology (panel dividing) with the matrix adapter plate
- Sanding, traced profiling etc., by exchanging a wide range of available units into the 18,5 kW working spindle
- High-speed drilling, trimming and sawing operations without tool changes with the Multi Processing Unit (MPU)
- Enhanced productivity due to simultaneous tool change during processing with the MPU

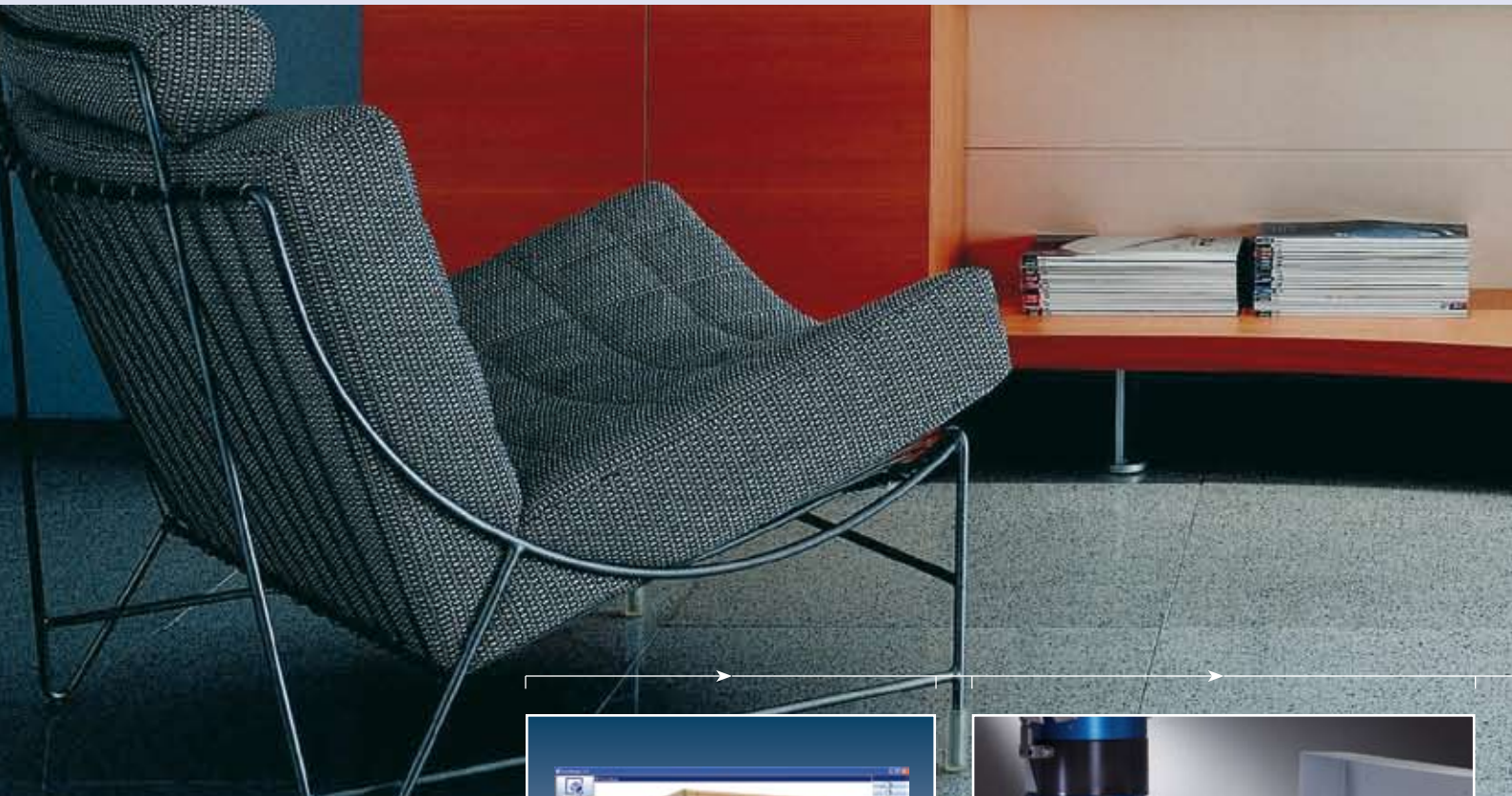

Comprehensive software package:

- Extra woodWOP software licence for office workstation including data transfer to DXF format (CAD)
- woodDesign – the graphic furniture design software for box furniture
- MDE Basic – machine data acquisition for production cost optimization



Highly flexible FLEX5+ sawing and drilling unit for five-axis processing

- Shift cuts fit right from the first go
- Drill holes at "any" angle
- Lamello grooves on "every" level
- Automatic tool change from additional 5-slot changer





# precision down to the last detail

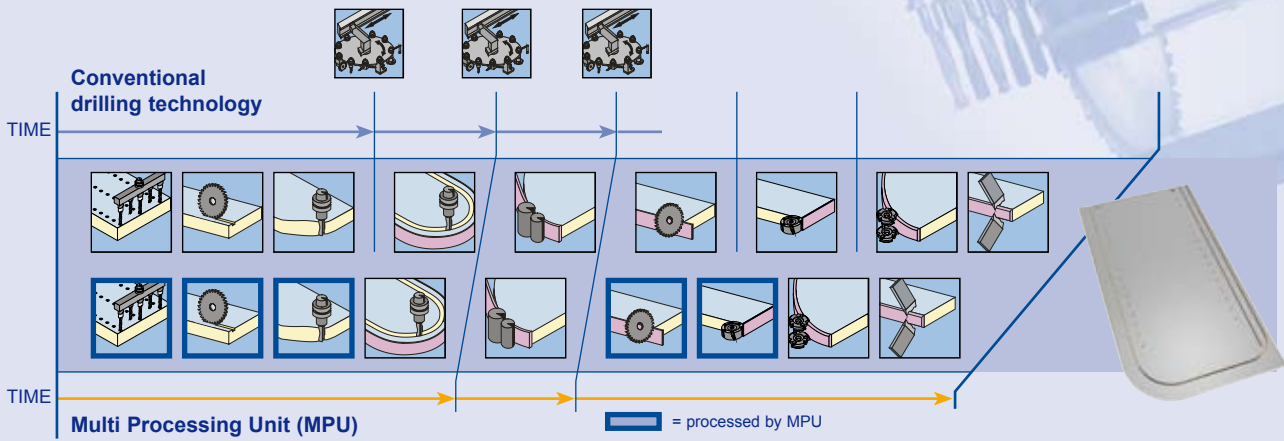

The multifunctional capability of the Multi Processing Unit permits formatting, sawing and drilling without the need for tool changes. As the MPU offers 360° swivel capability, processing operations can actually be performed at "any" angle.

While the MPU is in use, tools can be exchanged into the working spindle, dramatically reducing downtimes to the benefit of improved productivity and lower piece costs.



**powerEdge** glueing unit for efficient edge banding including 360° butt joint glueing even for small batch sizes:

- ABS edges
- PVC edges
- Veneer edges



The Multi Processing Unit (MPU) permits the drilling of rows of holes or drilling using individual drilling tools either horizontally or vertically at any optional angle. In conjunction with the integrated saw and a 6 kW trimming spindle (optional), most workpieces can be executed without time spent changing the tool



The fast, reliable way to achieve your finished furniture product. All in a day's work for Venture machines 21 and 23.

# High-End Features – all inclusive



Highly rigid machine bed with integrated waste piece disposal over entire processing depth of 1,300 (Venture 21) / 1,600 mm (Venture 23). No waste pieces drop in front of the machine (optionally with chip conveyor belt)



Two separate Z axes permit tool changes during processing operations with the MPU in conjunction with the 5-slot plate changer

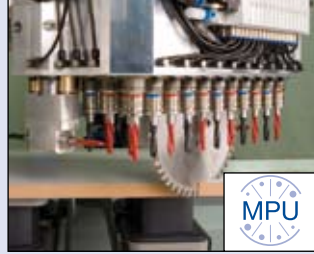

Multi Processing Unit (MPU) with its own 360° swivel axis for drilling and sawing at any angle. 30 drilling spindles and a saw with a 200 mm diameter are ideal for fast complete processing without tool changes. Optionally with 6 kW supplementary spindle to increase the processing depth by 590 mm

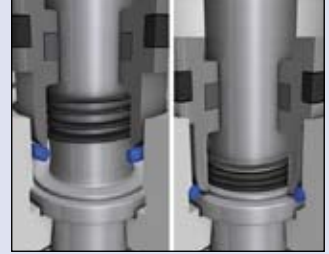

Automatic spindle clamping: patented system for precise drilling depth every time even with different materials

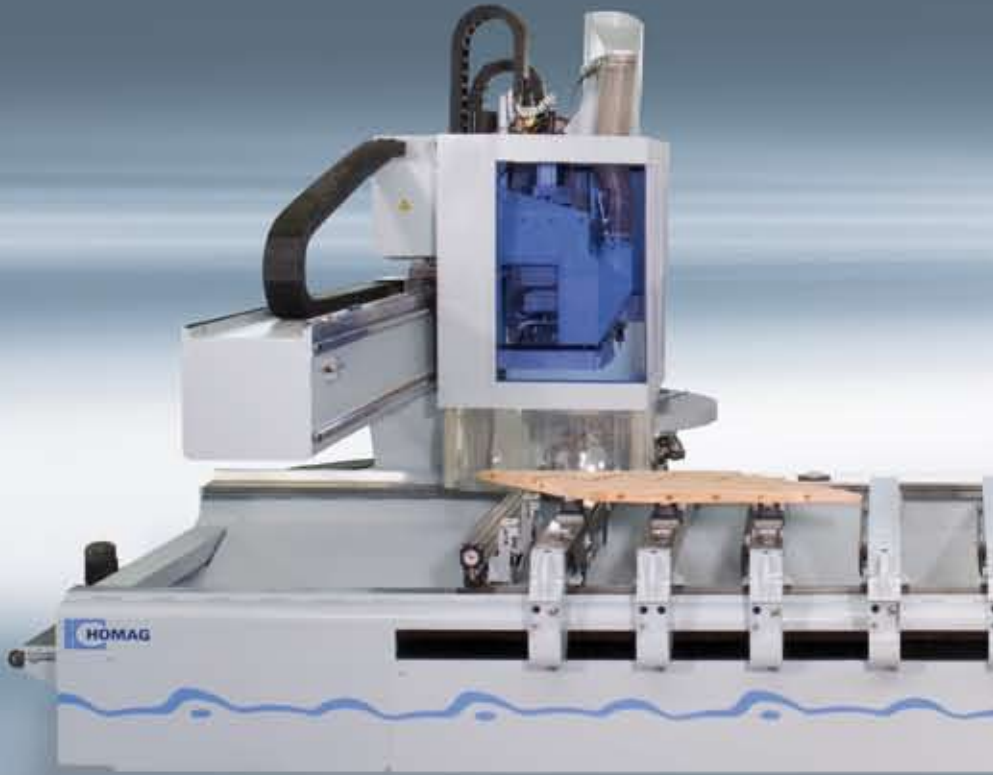

Stop dogs with end position monitoring to prevent damage to tools and units. Automatic central lubrication for maintenance-free reliable operation



Interpolating C axis 360°: to allow units to be rotated at any optional angle, including compressed air transmission to the units (e. g. for cleaning away chip residues by air jet or for traced processing operations)

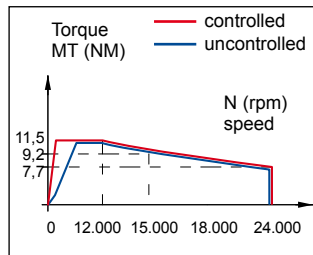

Working spindle (18 kW) with controlled spindle speed 0 - 24,000 rpm for extreme torque even at low speeds, for example when sanding. A spindle sensor takes care of optimum protection of the working spindle, for instance in case of tool unbalance.



Working table with 6, 8 or 10 consoles and precise linear guides ensuring optimum workpiece clamping for heavy-duty hogging operations



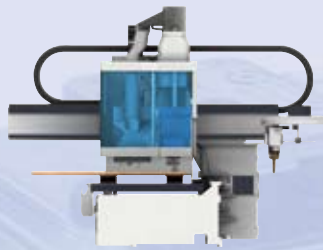

The compact, transparent safety cover allows oversized workpieces to project beyond the machine bed



Fast plate changer with 18 generous slots for tools and units with a diameter of up to 180 mm

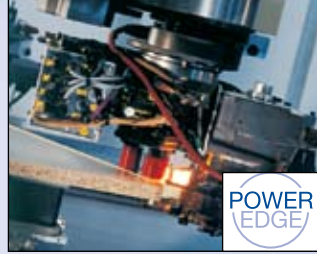

POWER  
EDGE

The patented electronic interface permits the use of exchangeable **easyEdge** and **powerEdge** edge banding units for perfect edge banding onto shaped components. Top class edge finish by means of finish processing units. HOMAG – experience gathered over thousands of successful installations working for your benefit



FLEX5

Unadulterated flexibility – the integrated FLEX5 interface can be retrofitted at any time with automatic angle adjustment: A unique feature for the precise execution of shift cuts or drilling and trimming operations at "any angle" without the need for manual setting work



**woodWOP:** The world's most frequently used programming system with **woodDesign** as a 3D design tool for a "short-track" route from the drawing to the finished machine program

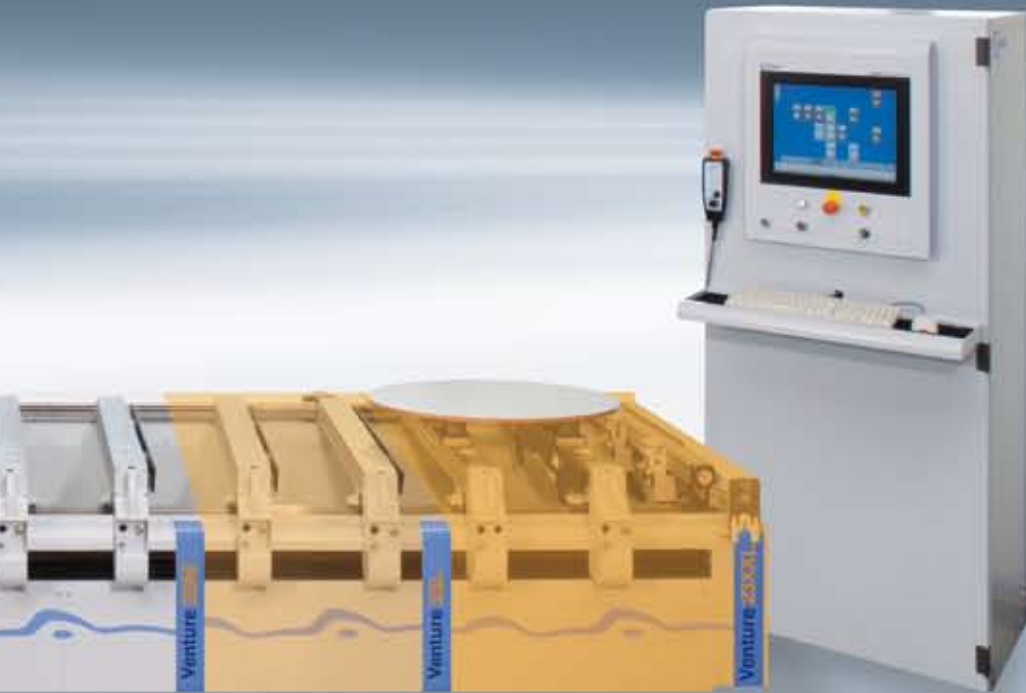

Durable insertion aids for support of heavy workpieces



LED displays for fast, simple positioning of vacuum clamps and consoles



**powerControl** system PC 85: with swivel-mounted control panel for simple machine operation using features such as the graphic tool database and machine data acquisition (MDA)



Uninterruptible power supply (UPS) to prevent data loss in case of power failure and mains voltage fluctuations

# Ingenious extras for unlimited production scope

A wise investment in the future:

The Venture grows flexibly step by step with your requirements. For other applications, please apply for our processing unit and clamping fixture catalogue.

## Durable solutions

Venture machines 21 and 23 stand for maximum future and investment security. Because they grow step by step with your changing requirements, they can be simply upgraded with new processing and adapter units at any time, making them ideally equipped to tackle new challenges. Economy in a minimum of space as a result of:

- Compression of work steps
- Reduced transport times and transport damage
- Reduced delivery periods
- Improved quality due to automatic sequences
- Data transfer from e. g. CAD systems, cutting down on necessary preparatory work prior to production



7471  
Tool transfer station, reliable, fast loading of the tool changer including empty slot interrogation in the tool changer



7519  
2-spindle sawing/drilling unit: for grooving, drilling and sawing (also for mitre cuts). As sawing/snipping unit (7513) with cutting depth up to 110 mm



7523  
4-spindle drilling/trimming unit: for trimming and drilling work with different tool diameters



7529  
Lock case trimming unit: with 2 spindles for horizontal trimming with integrated cleaning air jet for chips



7535  
Vertical trimming unit with tracing ring: e. g. for highly precise work surface joints



7544  
Horizontal trimming unit for heavy-duty trimming work: e. g. for staircase handrail processing



7547  
Corner snipping unit: for precise recesses in doors or work surfaces



7549  
Sanding unit with cleaning air jet: Guaranteed perfect for solid wood coupled with a long service life



7568/7574  
FLEX5 sawing/drilling unit with automatic swivel action: for processing operations at any optional angle, e.g. shift cuts (7568) or as FLEX5+ with automatic tool change and additional 5-slot changer (7574)



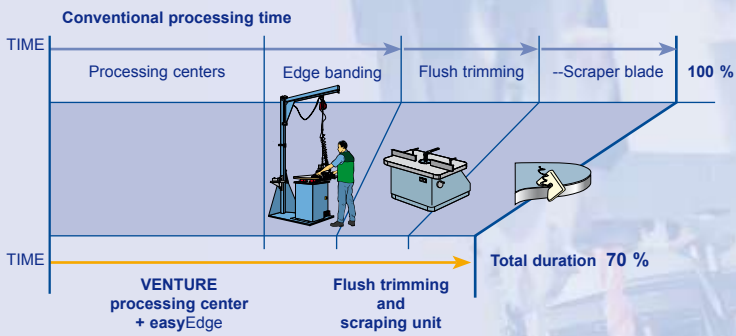

Precisely tailored to the needs of an universal production. With the **easyEdge** gluing unit you will save space and time. Edge by edge, to an exemplary standard of quality.

**powerEdge gluing package 7620 with combi-trimming and scraping unit and single snipping station**



The **powerEdge** gluing unit offers perfect all-round gluing with a feed rate of up to 20 m/min.



Top-quality results – the traced combi-flush trimming scraping unit which makes use of the drive system, the C axis and the pneumatic system produces stunning edge appearance. Once again, technology developed and patented by HOMAG

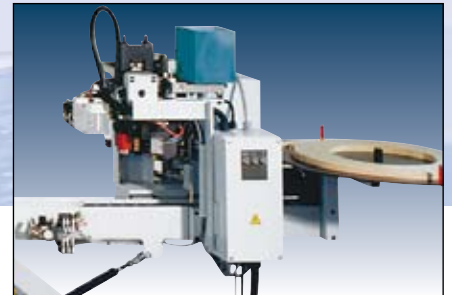

Added convenience is provided by the pick-up station with single rough snipping unit – the best solution for efficient processing of coil material

**easyEdge gluing package 7623**

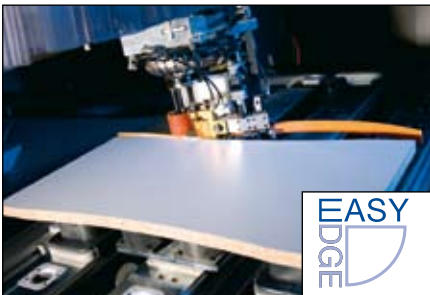

**easyEdge** gluing unit for efficient edge banding on shaped components. Naturally also contained in the combi-flush trimming scraping unit package

**Other options**



7255-7258  
Maxi-Flex clamping system for flexible shaped component clamping



7260/7261  
**powerClamp** clamping system for reliable clamping of window components

**Other options**

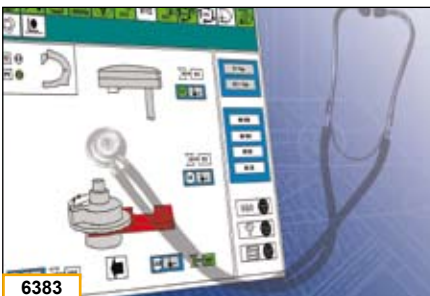

6383  
**woodScout**: The system permits systematic, fast troubleshooting and results in a substantial increase in machine availability

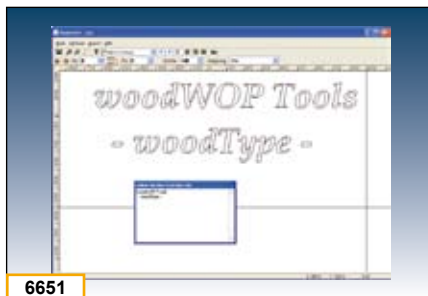

6651  
**woodWOP Tools**: Software tool package for nesting (cutting waste optimization for shaped components), programming of engravings and file management using a browser

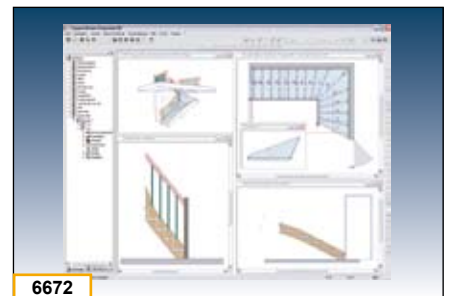

6672  
**woodStairs**: Staircase software for the design of staircases including data transfer to the Venture

**HOMAG software products – everything from a single, reliable source.**

For additional software packages, please request our brochure "Software for processing centers".

# Specifications **Venture 21/23**

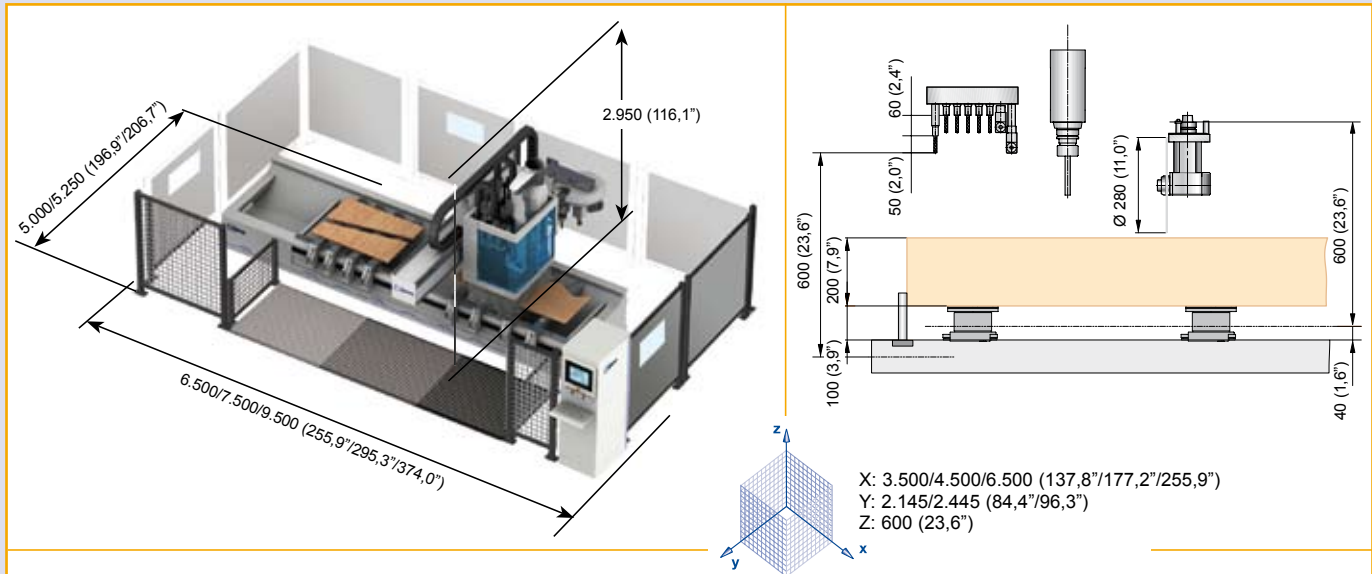

© HOMAG AG nat. 04/2019

X1 = single operation  
X2 = 2-fold operation  
X3 = alternate operation

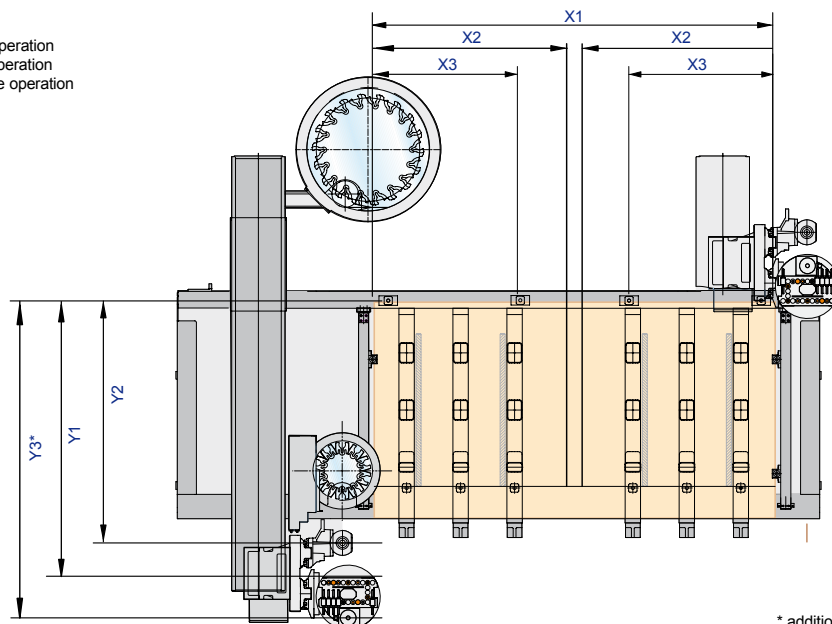

\* additional spindle (optional)

	X1	X2	X3	Y1	Y2	Y3*
<b>Venture 21M</b>	3.225 mm (127,0")	1.475 mm (58,1")	1.075 mm (42,3")	1.850 mm (72,8")	1.550 mm (61,0")	2.140 mm (84,3)
<b>Venture 21L</b>	4.175 mm (164,4")	1.950 mm (76,8")	1.550 mm (61,0")			
<b>Venture 21XXL</b>	6.175 mm (243,1")	2.950 mm (116,1")	2.550 mm (100,4")	2.150 mm (84,6")	1.850 mm (72,8")	2.440 mm (96,1")
<b>Venture 23M</b>	3.225 mm (127,0")	1.475 mm (58,1")	1.075 mm (42,3")			
<b>Venture 23L</b>	4.175 mm (164,4")	1.950 mm (76,8")	1.550 mm (61,0")			
<b>Venture 23XXL</b>	6.175 mm (243,1")	2.950 mm (116,1")	2.550 mm (100,4")			

Specifications and photos are not binding in every detail. We reserve the right to make changes in the interests of further development.

A member of the HOMAG Group



**HOMAG Holzbearbeitungssysteme AG**  
 Homagstraße 3–5  
 72296 SCHOPFLOCH  
 GERMANY  
 Tel. +49 7443 13-0  
 Fax +49 7443 13-2300  
 info@homag.de  
 www.homag.com