

LEDINEK

CROTOLES

System

The other way of planing

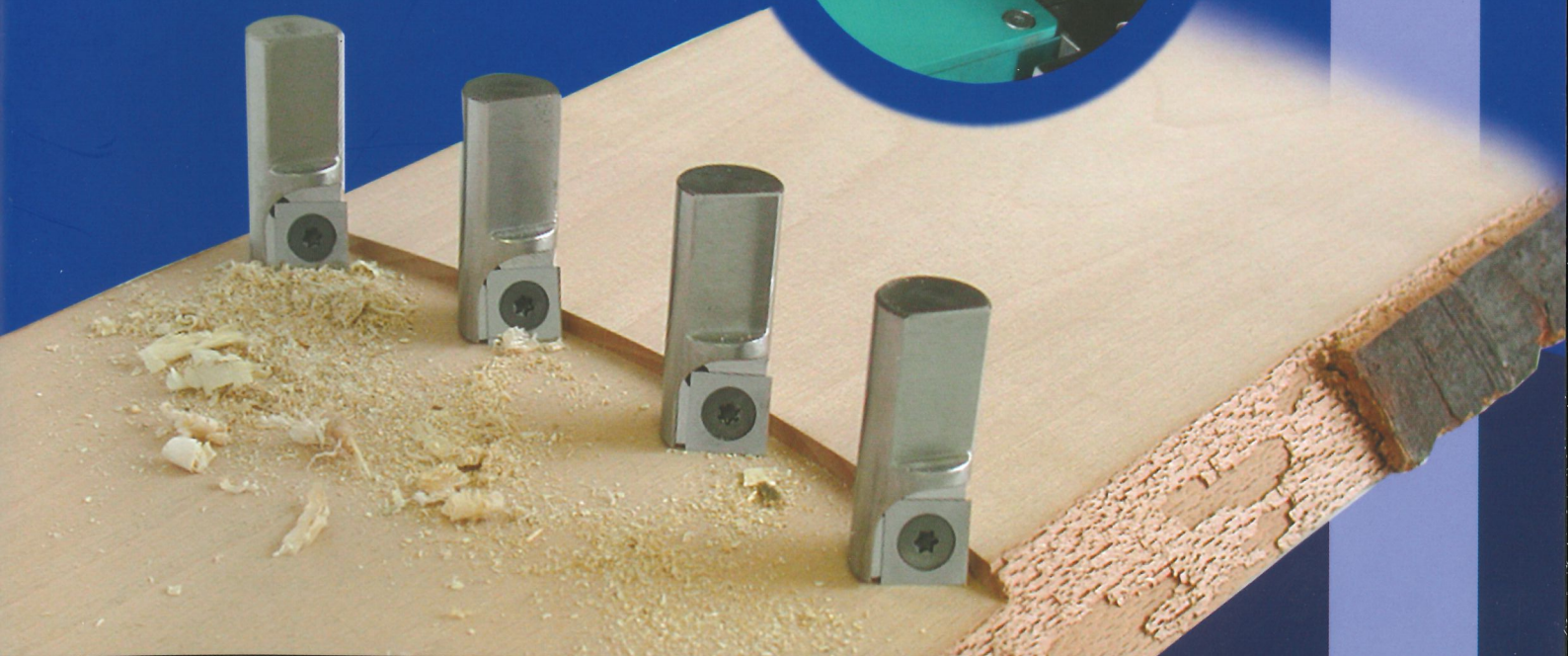

SIEMENS SIMATIC 6ES7 311-1CG03-0AB0

Autopositionierung		MENU
Parameter	Sollwert (mm)	Istwert (mm)
Dicke	000,0	000,0
Breite	000,0	000,0
Abnahme Tisch	000,0	000,0
Abnahme RW	000,0	000,0
Eingangrolle	000,0	000,0
Slip Horizontal	000,0	000,0
Slip Leiste	000,0	000,0
Start	Vorschub: 000 m/min	Stop

TOUCH

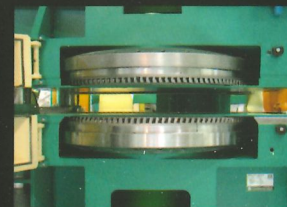

Rotoles System

Rotoles System is a new method in woodworking offering better economic effects

No progress means regression. This rule also applies to technologies, which were believed to be at a peak of their development. An example of that is also the worldwide patented ROTOLES SYSTEM for front milling of wood, wooden products, plastics and light alloys.

United States Patent Number 4,964,446

Europäisches Patent Nr. 0382877

Main Principle of Working with Rotoles System

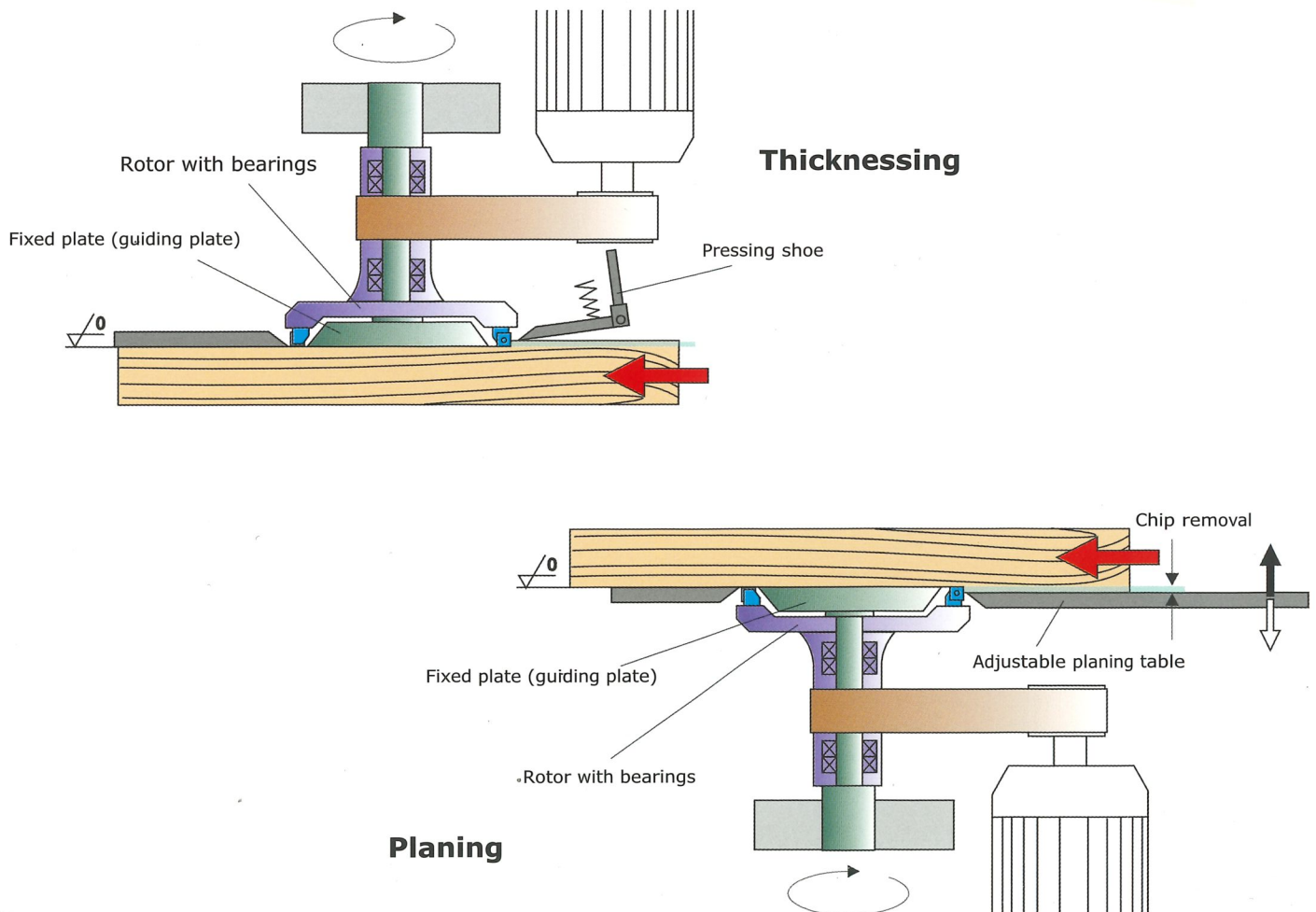

Rotoles Advantages

Working with the Rotoles System has following advantages:

Straightness of Planing Surface

Conventional Planing

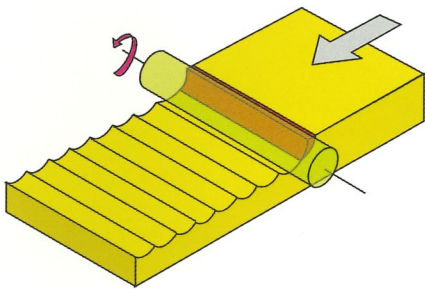

Rotoles System

No shaft marks, perfectly flat surface.

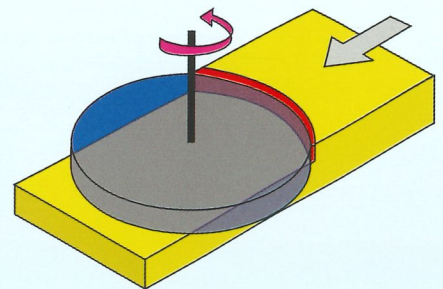

Curved guiding across the tool

No planer marks on both ends of a woodpiece.

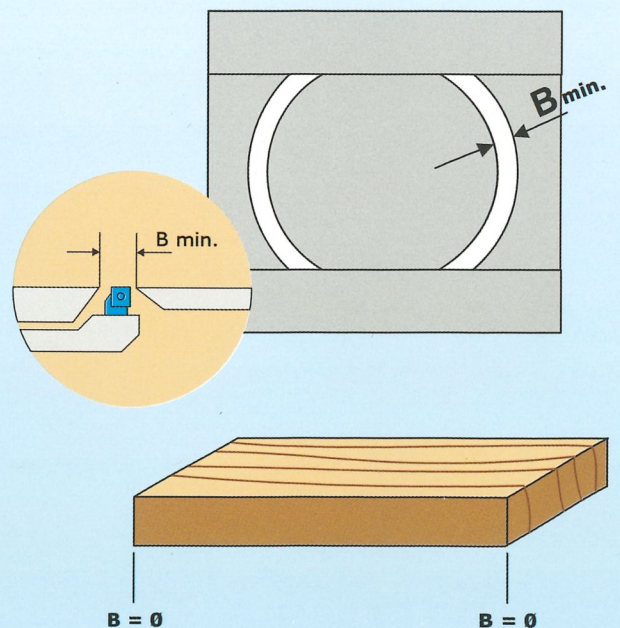
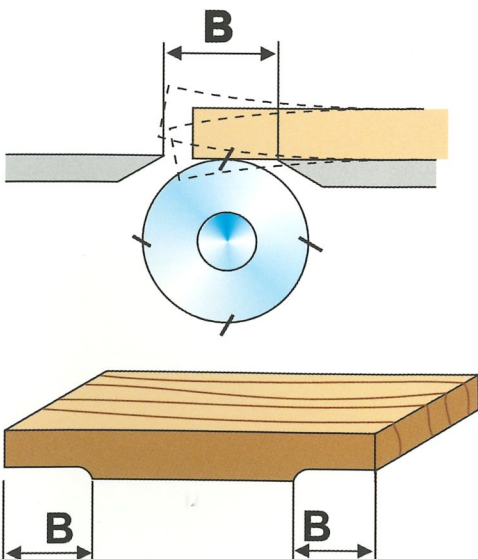

Surface Straightness Independent of Tool Wear Out

Rotoles System

One worn out knife does not affect the surface regularity, because each cut is overlapped in width and length by the following knives.

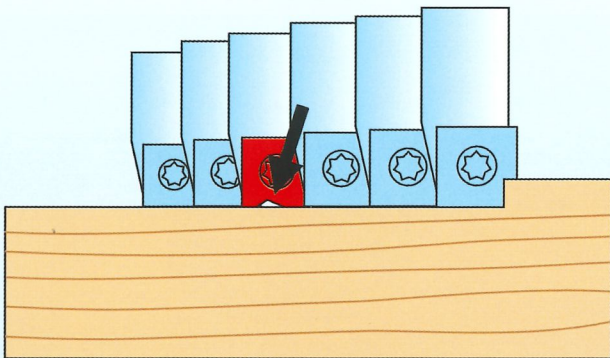

Conventional Planing

Assymetrical knife wear or damage

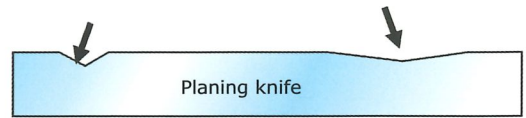

result in uneven surface

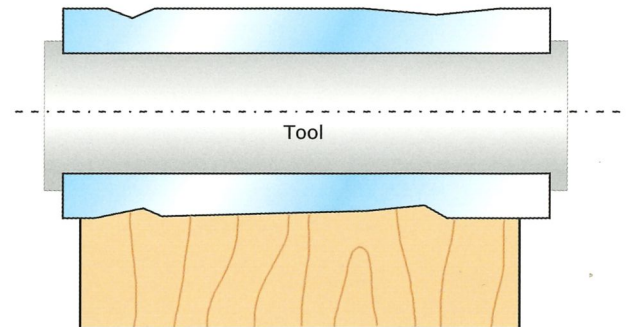

Excellent machining of wood knots and their edges without tear out.

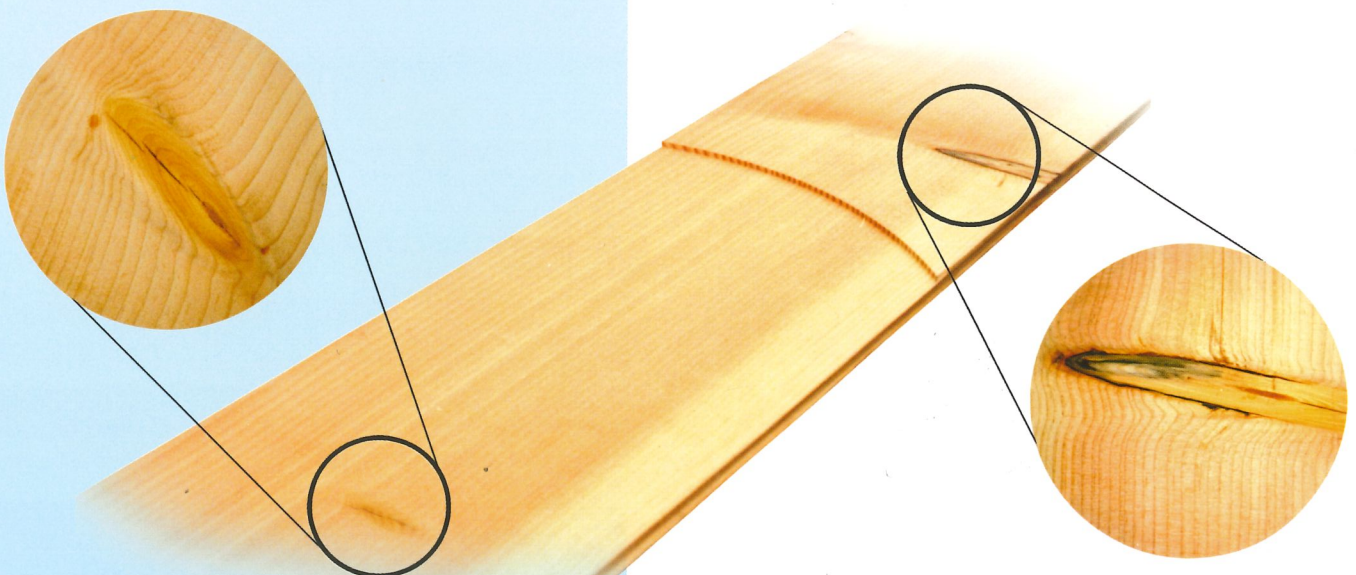

Open Pore Surface

Conventional Planing

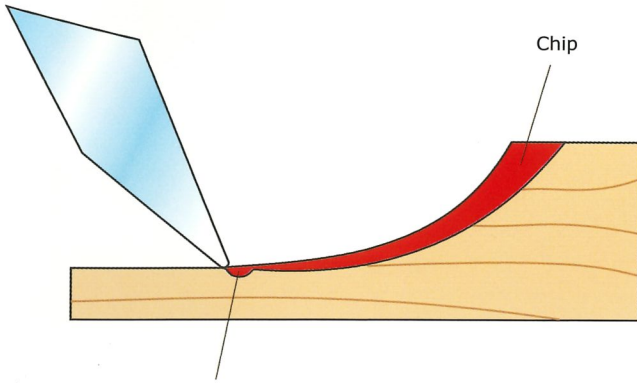

- Deformation of cell structure
- Crystallized resin

Closed cell structure

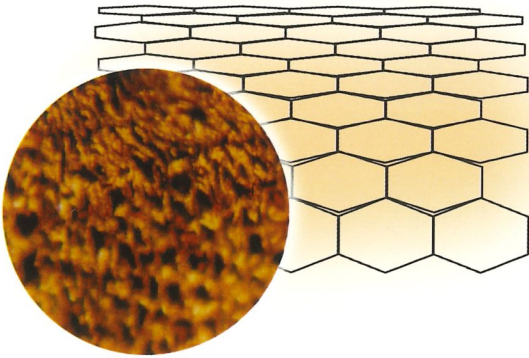

Poor agglutination

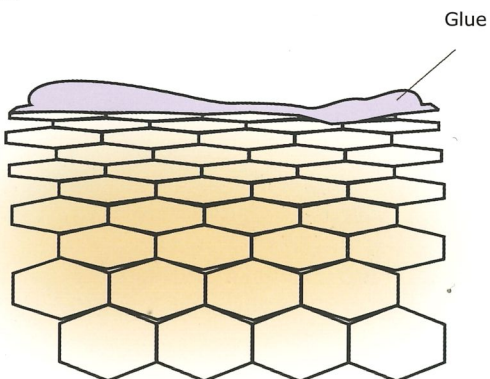

Rotoles System

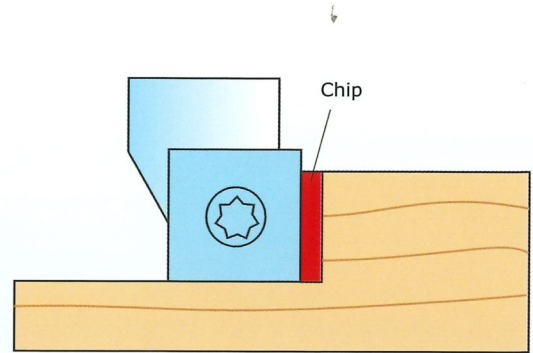

- No deformation of cell structure
- No crystallization of resin

Open cell structure

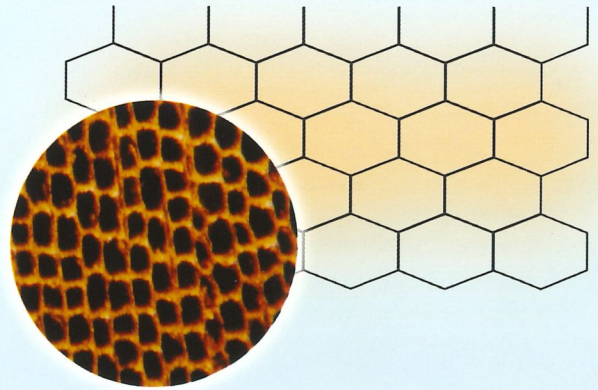

Stronger joint

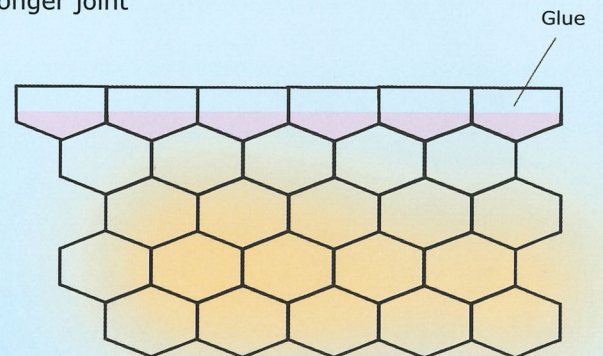

Reduced consumption of glue

Rotoles Tools

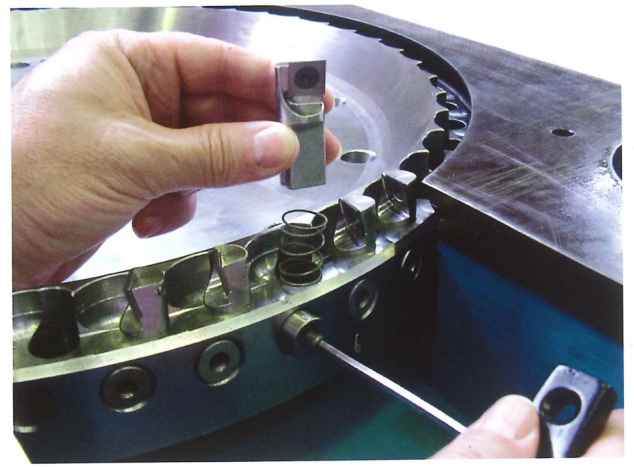

The ROTOLES tools (rotary heads) are mounted parallel to the machining surface. On multi-side machines, rotary heads are positioned directly above each other, resp. directly opposed for vertical machining. A number of single cutting knife plates arranged around the rim of the rotor enable very small chip thickness from 0,1 to 0,5 mm per knife. The machining is steady and smooth due to lower cutting force and pressure from a single knife against the workpiece. The result is a perfectly machined surface of a workpiece.

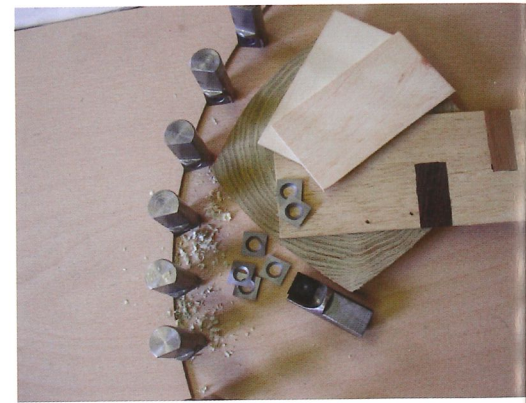
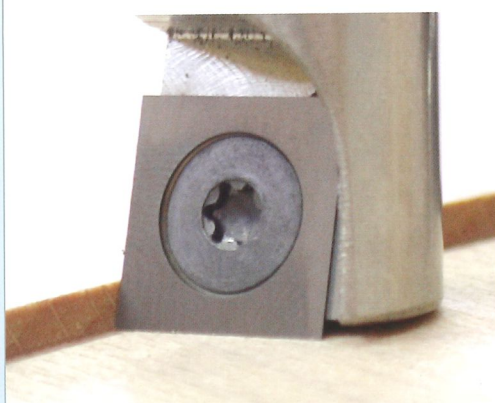

The tool turns in horizontal level from left to right and works like a milling cutter. It is possible to work with very short workpieces without planer marks on both ends. The tool is equipped with carbide inserts. After they are worn off on one side they can be turned. An insert can be turned up to 4 times, after that it must be replaced.

The blade holders are fixed in the rotor by clamping wedges

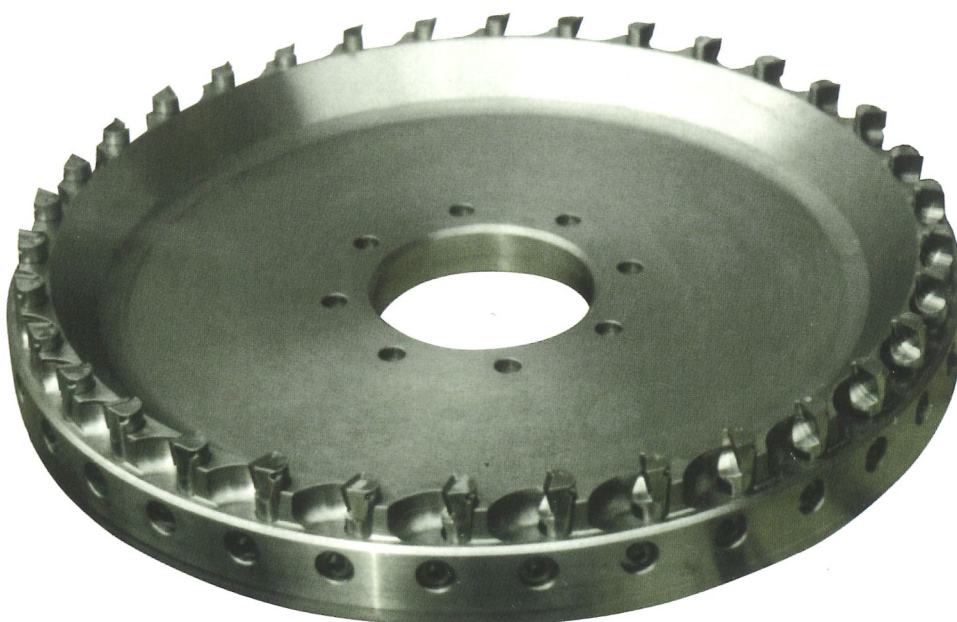

Rotoles Program

Excellent machining of wood knots and their edges. Suitable for extremely dry saw timber; recycled timber as well as large solid panels can be machined precise and with ease.

ROTOLES machines with roll feed

Multi- sided calibrating milling machines - moulders
Working width from 200 up to 600 mm

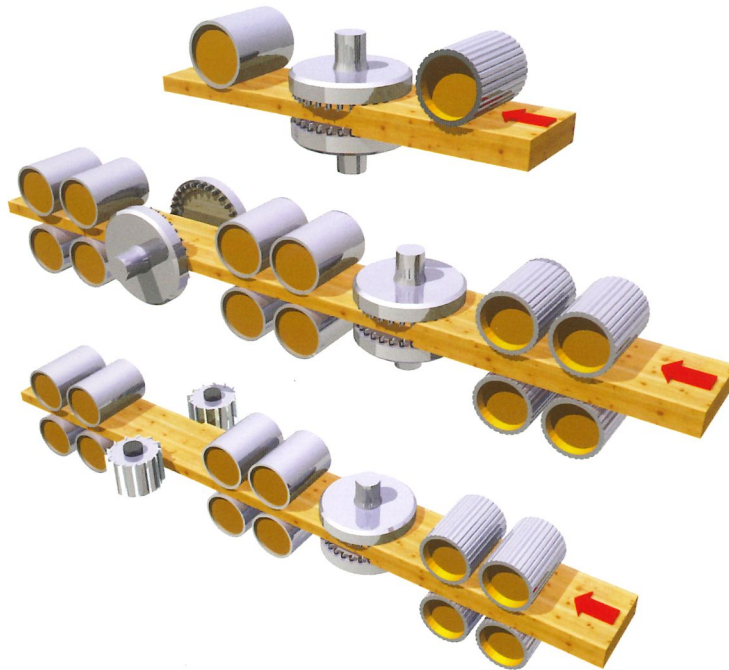

ROTOLES machines with band and/or chain feed



One-side calibrating milling machines
Working width from 300 up tu 2100 mm

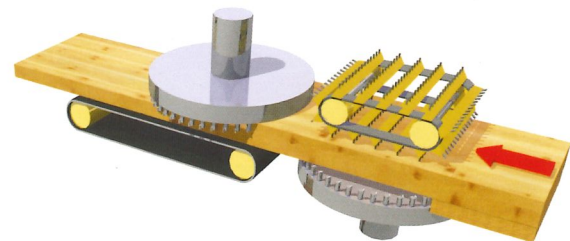

Double-side calibrating milling machines
Working width from 200 up to 1350 mm

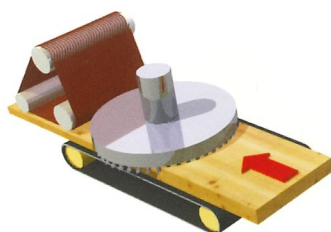

**One-side calibrating milling machines
with sanding aggregate**
Working width from 400 bis 1350 mm

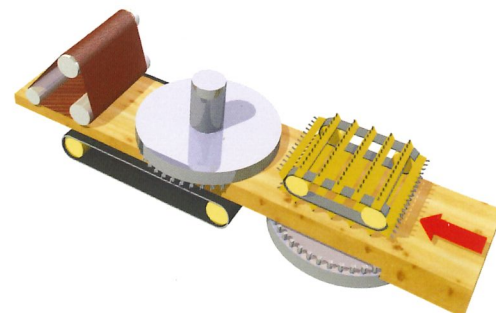

**Double-side calibrating milling machines
with sanding aggregate**
Working width from 400 up to 1350 mm

Rotoles machines with band or chain feed

Pressure segments before the top rotor hold down the workpiece.

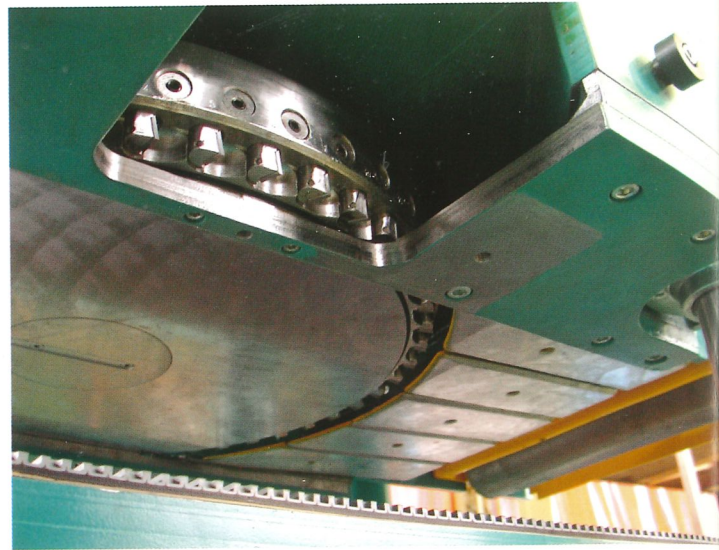

A cleaning brush sweeps the surface before final processing.

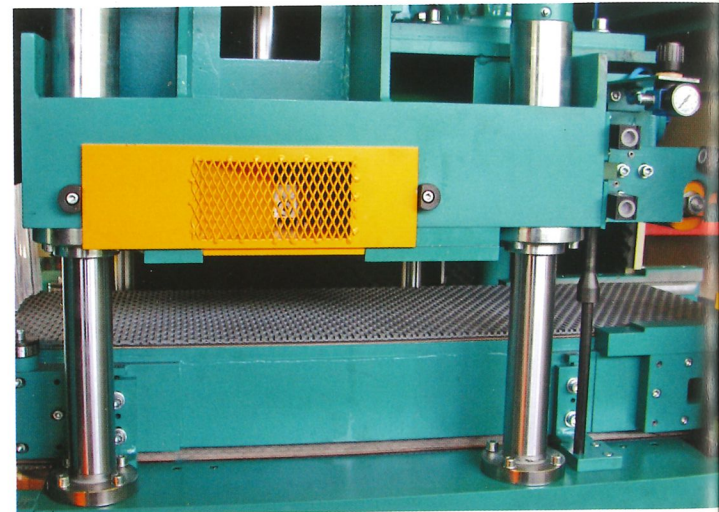

The friction between rubber conveyor and workpiece secures a perfect feed motion.



A feeding chain with spring loaded pins will transport concave or pieces with variable thickness reliably over the bottom rotor.

The combined sanding unit with a contact roller and a sanding shoe is an optimal solution for precise and fast changeover between calibrating and finishing operation.

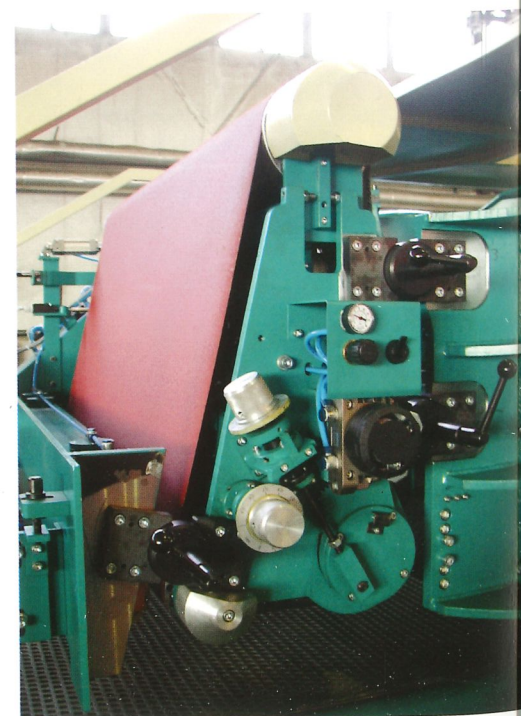

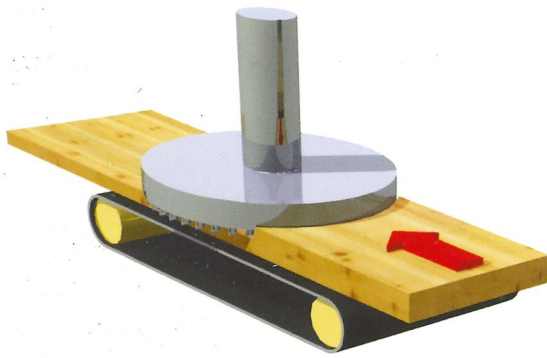

One-side calibrating milling machines Working width 300, 400 mm

For perfect calibration without damage at high speed.
These machines are especially suitable for machining thin woodpieces,
for example saw-cut veneer.



Rotoles 300 D-L

Workpiece width (mm):	30 - 300
Workpiece height (mm):	2 - 150
Workpiece length "min" (mm):	80
Feed speed "up to" (m/min):	25
Weight "approx." (kg):	900

Rotoles 400 D

Workpiece width (mm):	40 - 400
Workpiece height (mm):	2 - 150
Workpiece length "min" (mm):	150
Feed speed "up to" (m/min):	45
Weight "approx." (kg):	1.800

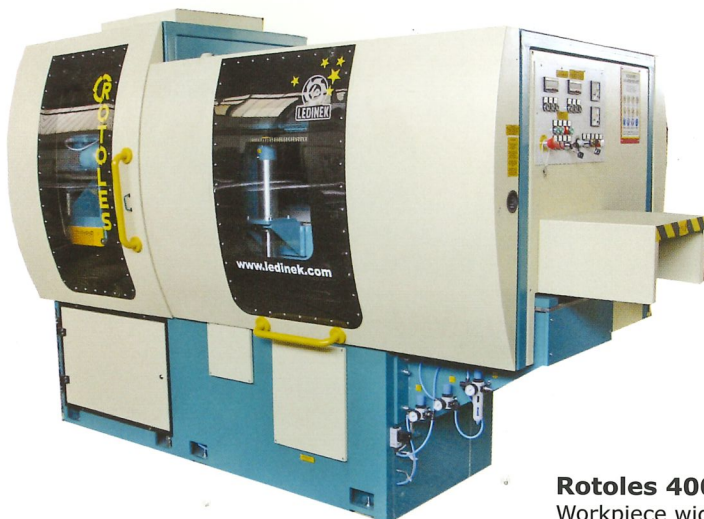

Rotoles 400 PD-SV

Workpiece width (mm):	60 - 400
Workpiece height (mm):	3 - 30
Workpiece length "min" (mm):	350
Feed speed "up to" (m/min):	45
Weight "approx." (kg):	4.500

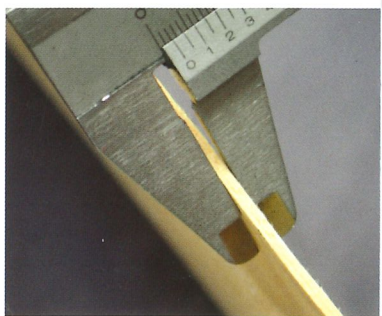
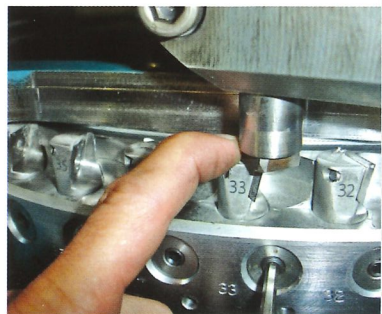
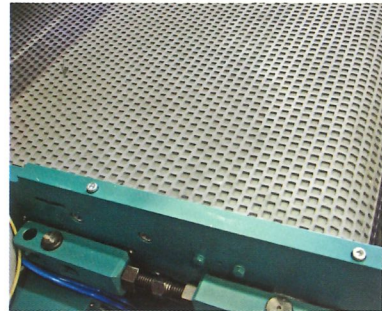
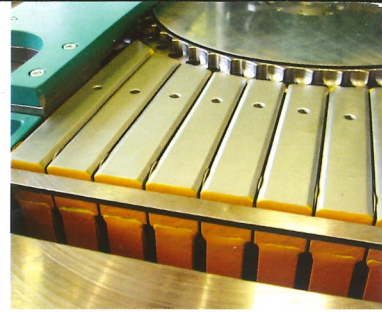

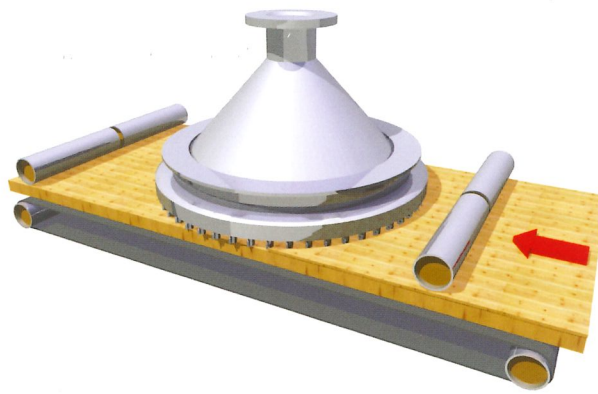

One-side calibrating milling machines Working width 600, 900, 1300, 2100 mm



Rotoles 600 D-L

Workpiece width (mm):	40 - 600
Workpiece height (mm):	2 - 150
Workpiece length "min" (mm):	80
Feed speed "up to" (m/min):	25
Weight "approx." (kg):	2.000



Rotoles 600 D

Workpiece width (mm):	40 - 600
Workpiece height (mm):	2 - 150
Workpiece length "min" (mm):	150
Feed speed "up to" (m/min):	30
Weight "approx." (kg):	5.400

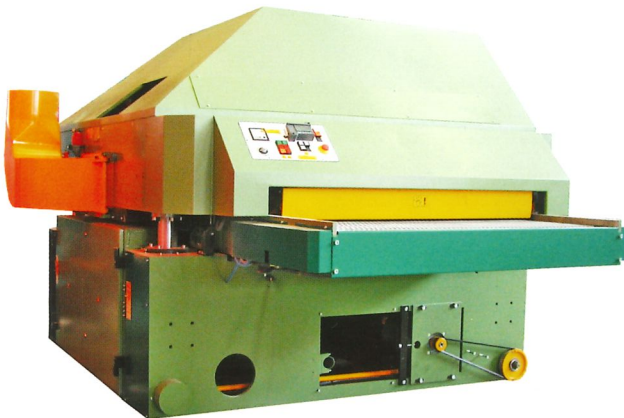

Rotoles 900 D

Workpiece width (mm):	60 - 900
Workpiece height (mm):	2 - 150
Workpiece length "min" (mm):	150
Feed speed "up to" (m/min):	36
Weight "approx." (kg):	8.500

Rotoles 1300 D

Workpiece width (mm):	60 - 1300
Workpiece height (mm):	2 - 150
Workpiece length "min" (mm):	150
Feed speed "up to" (m/min):	36
Weight "approx." (kg):	11.500



Rotoles 2100 D

Workpiece width (mm):	100 - 2100
Workpiece height (mm):	2 - 150
Workpiece length "min" (mm):	150
Feed speed "up to" (m/min):	36
Weight "approx." (kg):	30.000

Rotoles machines with roll feed

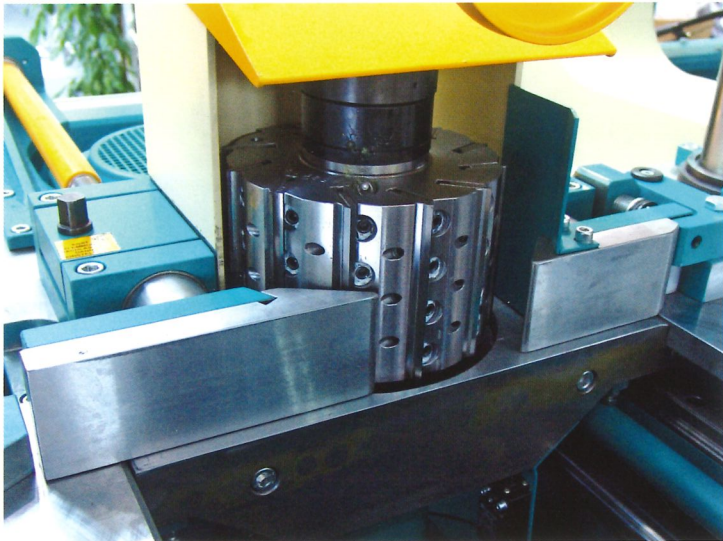

Vertical spindles can also be adapted for moulding.

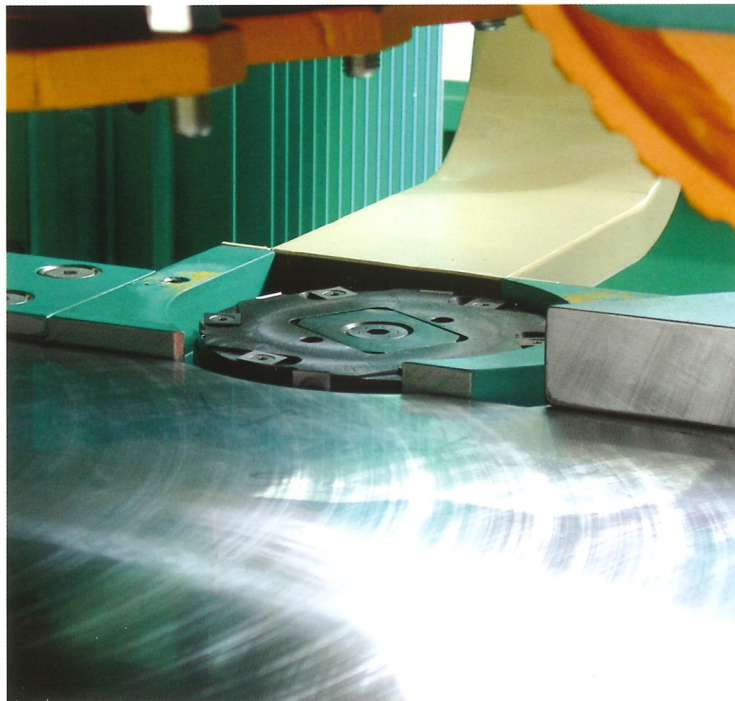

A precutter machines the edge of the workpiece to prevent tear out.

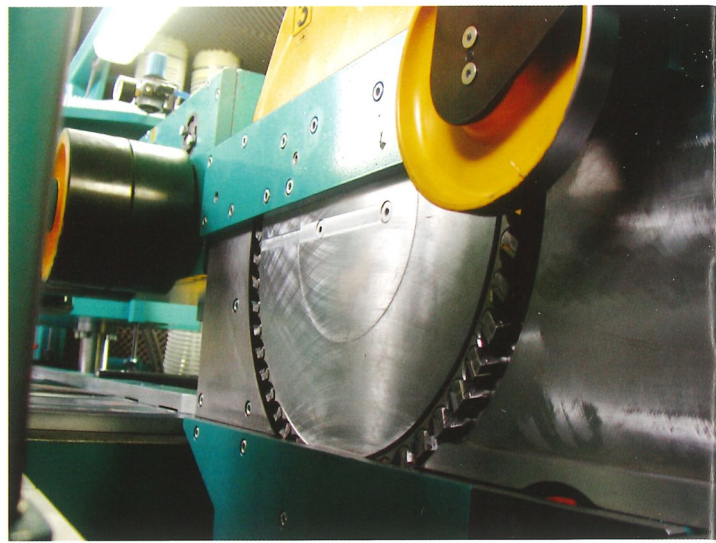

Opposite vertical rotors are the best choice for perfect calibration and excellent gluing performance.



High precision of horizontal planing is achieved by a very short distance between the two rotors.

Rotoles High Speed

Multi-side calibrating milling machines

A heavy-duty four-side combined calibrating milling machine with Rotoles system, vertical spindles, groove saw and a cleaning brush; for demanding calibration of glulam laminations.

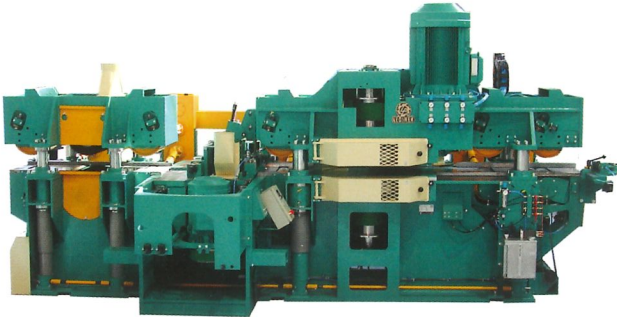

Tempo 230 m/min

Rotoles 300 4V-KS

Workpiece width (mm):	70 - 320
Workpiece height (mm):	19 - 120
Workpiece length "min" (mm):	3.000
Feed speed "up to" (m/min):	230
Weight "approx." (kg):	19.500

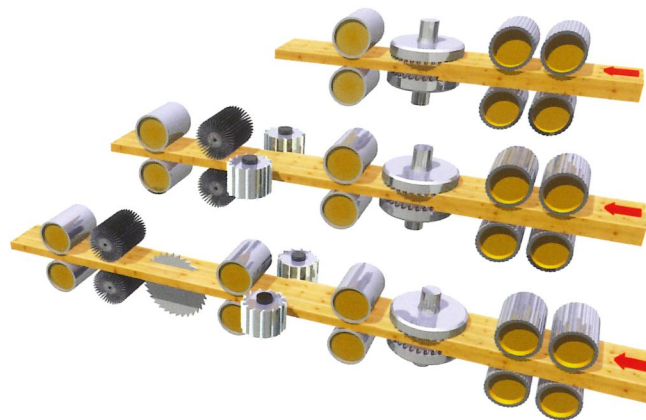

Rotoles 300 2V-KS

Rotoles 300 4V-KS

Rotoles 300 5V-KS

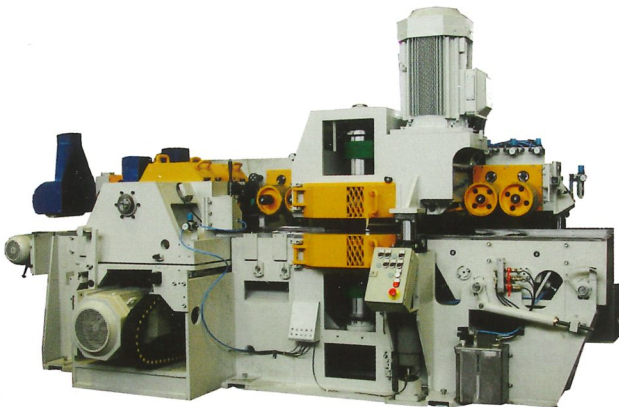

Tempo 80 m/min

Rotoles 300 4V-KS

Workpiece width (mm):	30 - 300
Workpiece height (mm):	14 - 150
Workpiece length "min" (mm):	1.500
Feed speed "up to" (m/min):	80
Weight "approx." (kg):	11.000

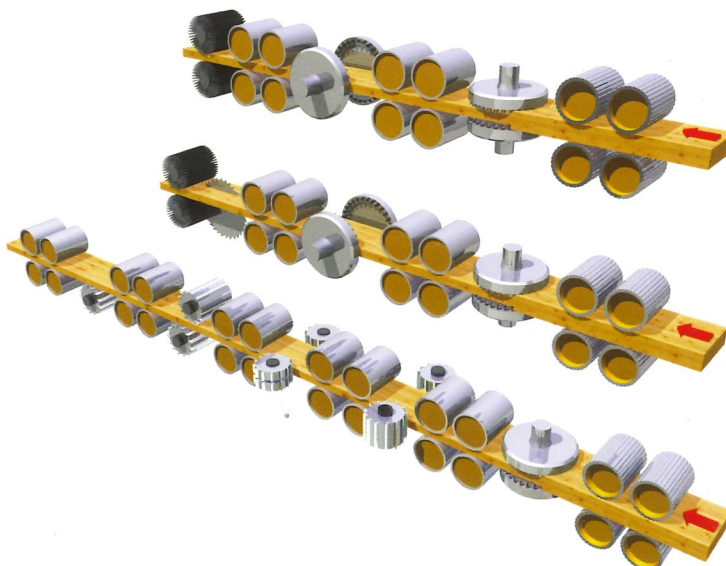

Rotoles 300 4VR

Rotoles 300 5VR

Rotoles 300 9V

Multi-sided milling machines - moulders

Depending on purpose, the wood can be calibrated on two or four sides with the Rotoles system, further processing is made by conventional spindles in various arrangements.

Rotoles 200 4V

Workpiece width (mm):	20 - 200
Workpiece height (mm):	8 - 150
Workpiece length "min" (mm):	800
Feed speed "up to" (m/min):	30
Weight "approx." (kg):	4.000

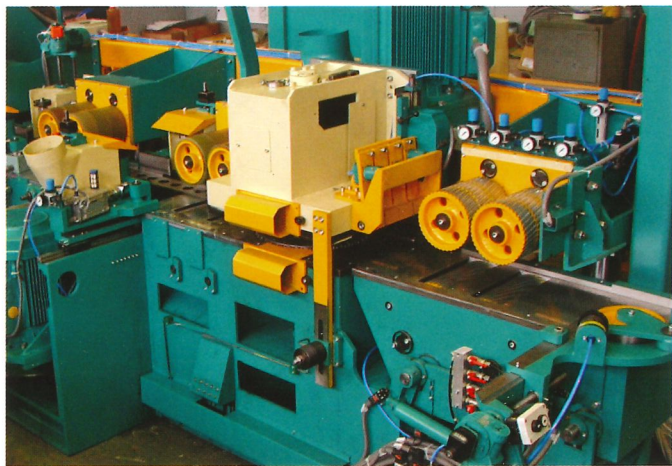
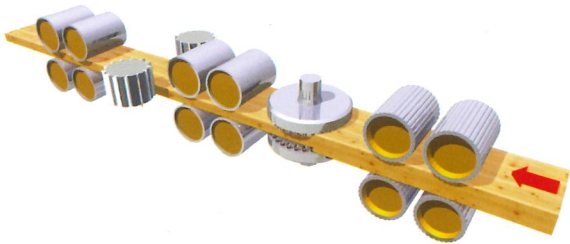

Rotoles 300 5V

Workpiece width (mm):	30 - 300
Workpiece height (mm):	14 - 150
Workpiece length "min" (mm):	1.200
Feed speed "up to" (m/min):	60
Weight "approx." (kg):	7.500

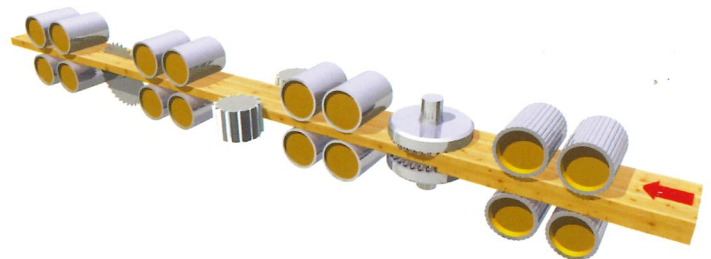

Rotoles 300 10V

Workpiece width (mm):	30 - 300
Workpiece height (mm):	14 - 150
Workpiece length "min" (mm):	1.200
Feed speed "up to" (m/min):	60
Weight "approx." (kg):	16.500

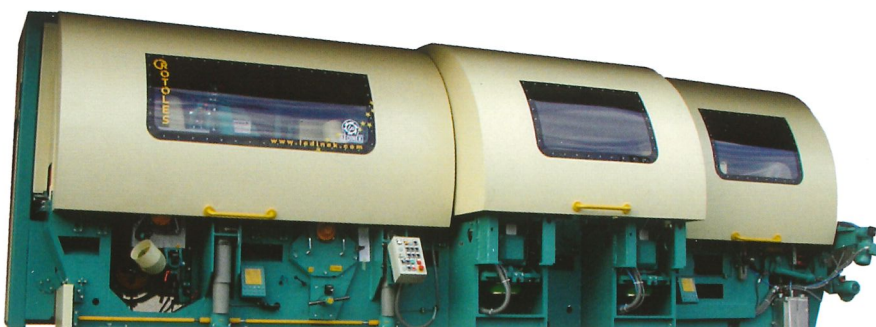
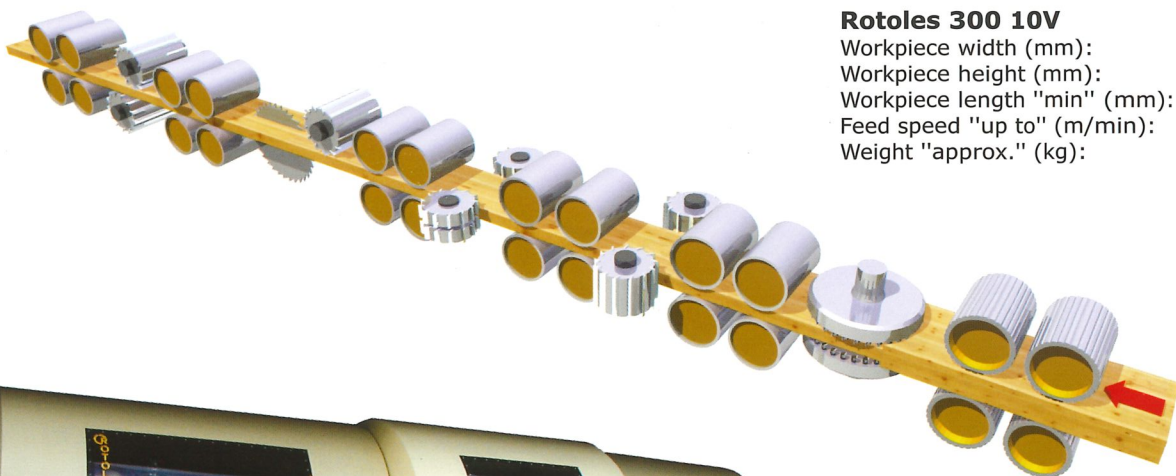

Double- and multi-side calibrating milling machines

Double- or four-side machines with Rotoles system for demanding calibration of single workpieces. The surface is machined evenly, regardless of fibre orientation and growth rings.

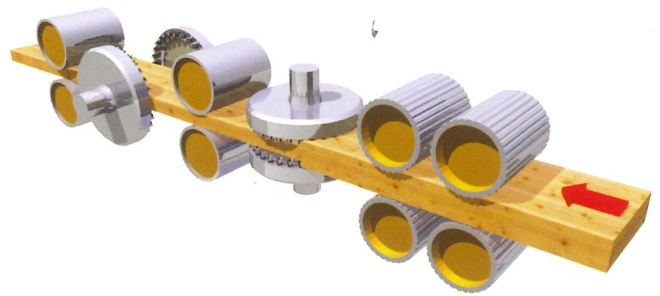
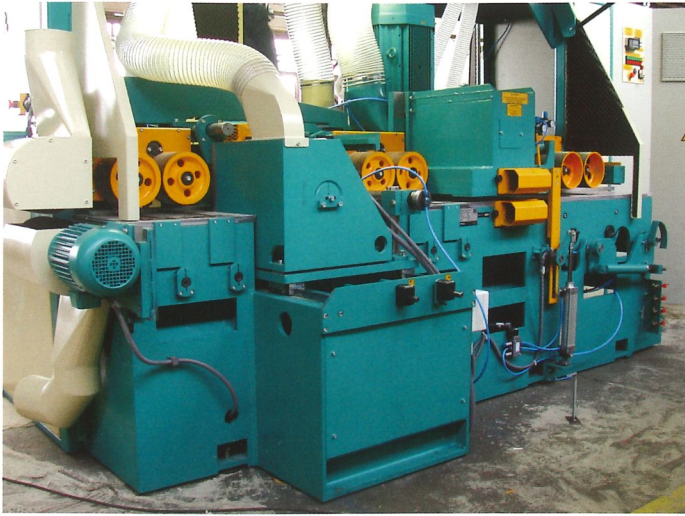

Rotoles 300 4VR

Workpiece width (mm):	30 - 300
Workpiece height (mm):	14 - 150
Workpiece length "min" (mm):	1.200
Feed speed "up to" (m/min):	30
Weight "approx." (kg):	6.500

Rotoles 400 2V

Workpiece width (mm):	40 - 400
Workpiece height (mm):	15 - 150
Workpiece length "min" (mm):	1.200
Feed speed "up to" (m/min):	60
Weight "approx." (kg):	4.800

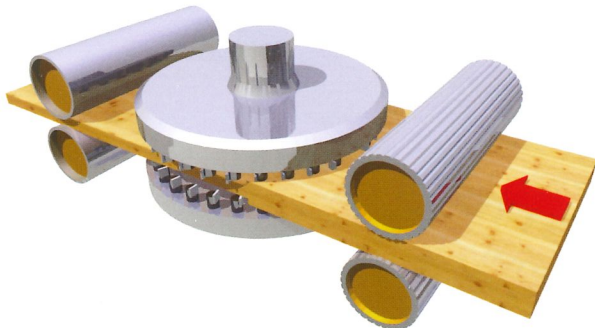
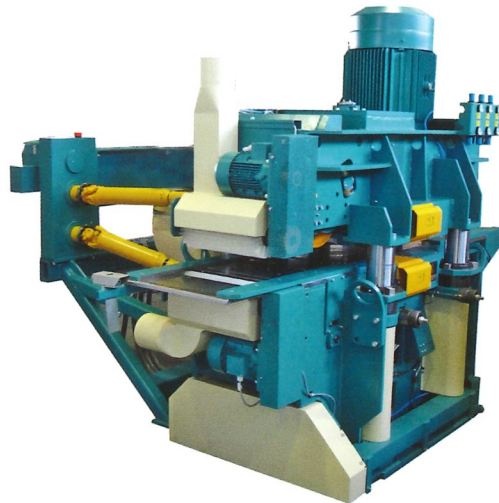

Rotoles 600 2V

Workpiece width (mm):	40 - 600
Workpiece height (mm):	15 - 150
Workpiece length "min" (mm):	1.600
Feed speed "up to" (m/min):	30
Weight "approx." (kg):	7.000

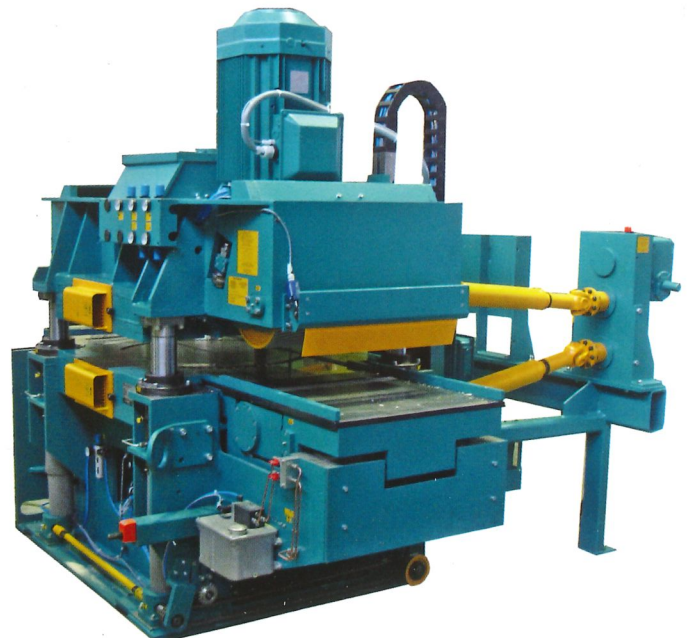

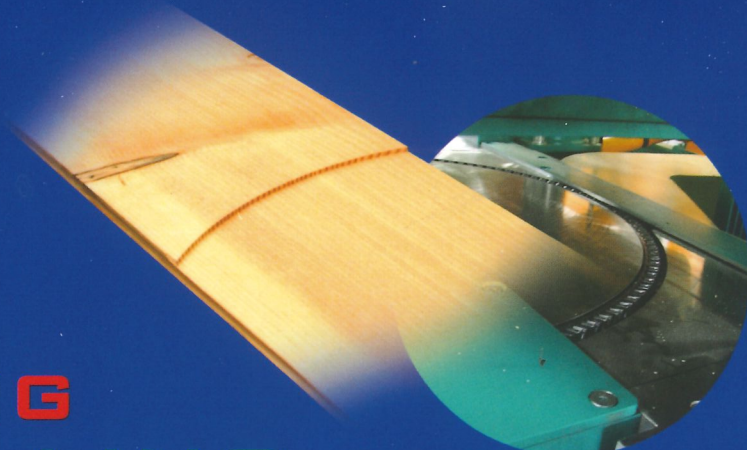

STOP PLANING START MILLING

The ROTOLES face milling method offers improved quality of machining compared to conventional planing: no planer marks, higher calibrating precision, perfect machining of wood knots and their edges, no deformation of structure therefore smooth and open pore surface. These features present significant advantages for certain following processing steps, for instance lower consumption of glue for glulam beams, panels and parquet, or better penetration of wood stain, oil or wax into the wood structure.

INNOVATIVE • POWERFUL • DURABLE

The cutting knives of the ROTOLES machines are industrially manufactured 'cemented carbide turnover knives'. Special PCD diamond tipped exchangeable tools are also available for applications, where extreme durability is required. The disposable tips are fixed on a quickly exchangeable holder, thus allowing very short down time for retooling. Additional time saving method on high speed machines are the tooling segments, which are equipped with preset new knife holders. The holders can be exchanged outside of the machine, only a lower number of segments have to be exchanged on the machine itself.

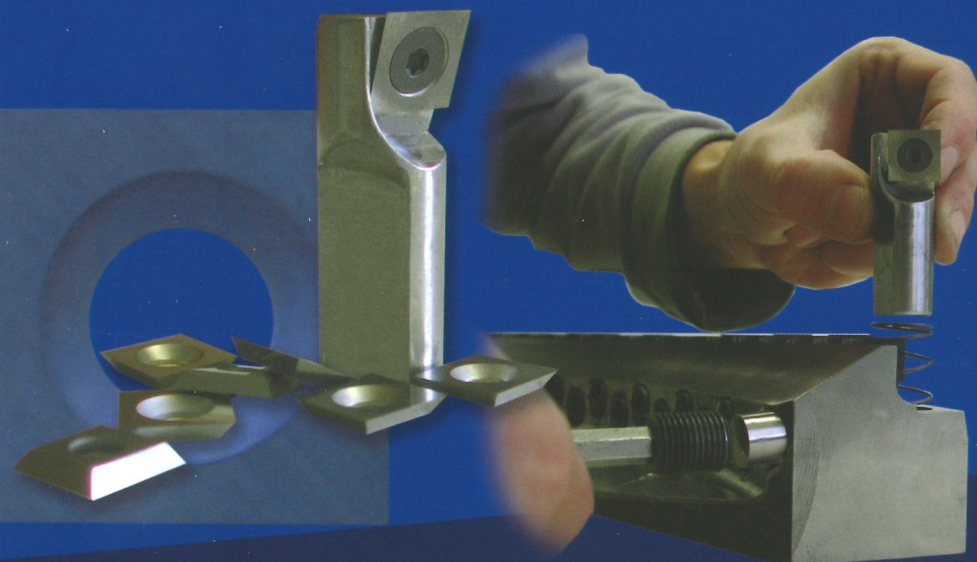

Die Firma Ledinek behält sich das Recht vor, Änderungen und Verbesserungen auf den Maschinen ohne Vorankündigung vorzunehmen.
The company Ledinek reserves the right to make any modifications retained opportune without any prior notice.

LEDINEK



ÖSTERREICH
Ledinek Maschinen und Anlagen G.m.b.H
A-9150 Bleiburg
Völkermarkter Straße 1
Tel.: +43 4235 5104
Fax: +43 4235 5103
E-mail: office@ledinek.at
Web: www.ledinek.com

DEUTSCHLAND
Ledinek - TEC Vertriebs GmbH
D-72818 Trochtelfingen - Mägerkingen
Bei der Mühle 6
Tel.: +49 71 24 93 13 89
Fax: +49 71 24 93 11 83
E-mail: info@ledinek.de
Web: www.ledinek.com



SLOVENIA (Verkaufsbüro / Sales Office)
Ledinek Engineering d.o.o.
Bohavska cesta 019 A
SI-2311 Hoče - Maribor
Tel.: +386 2 6130061
Fax: +386 2 6130060
E-mail: info@ledinek.com
Web: www.ledinek.com

