

■ made  
■ in  
■ Germany

**Paul**  
Maschinenfabrik GmbH & Co. KG

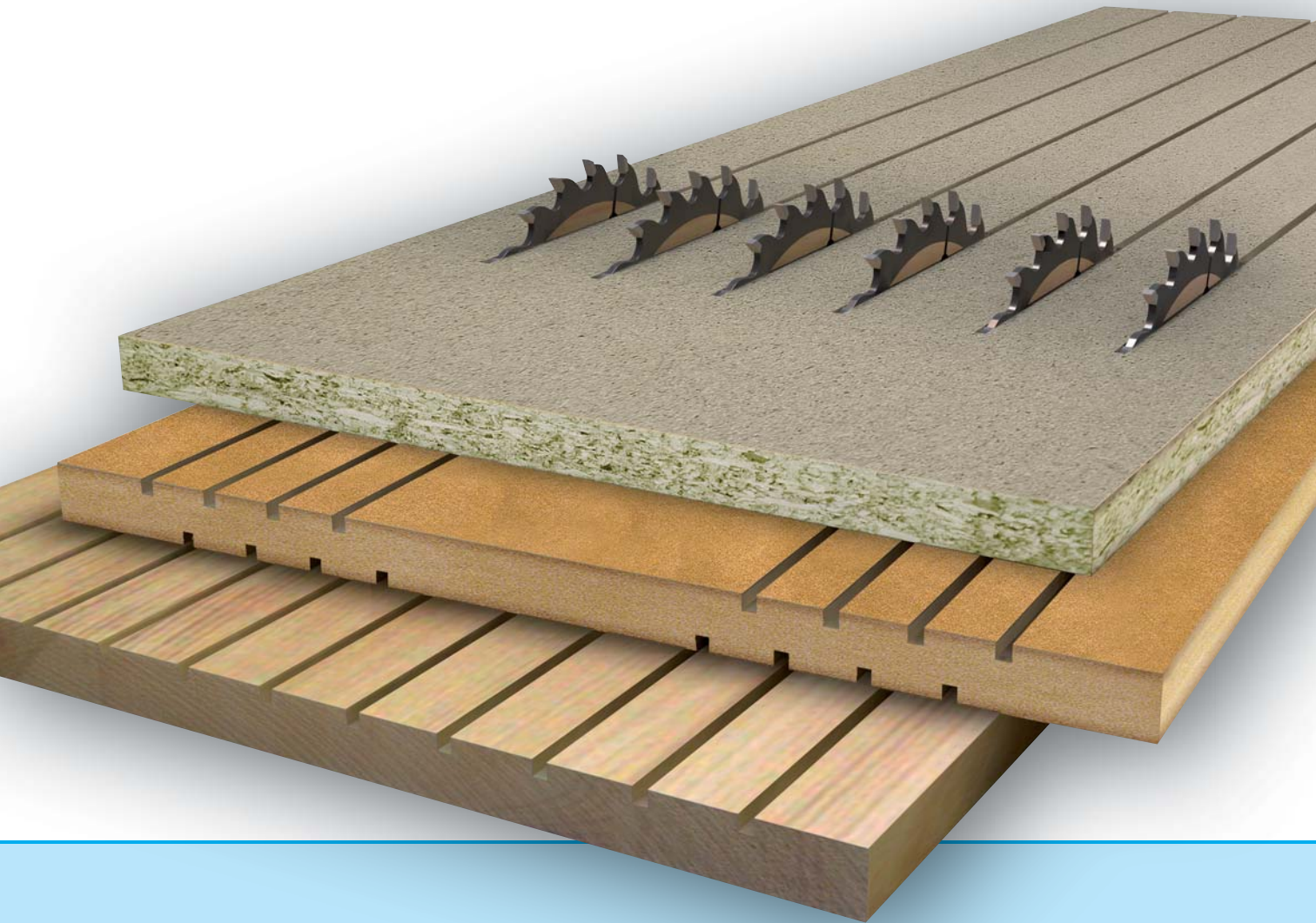

# Multirip Circular Saws Series K34

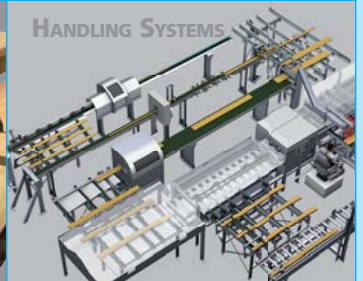
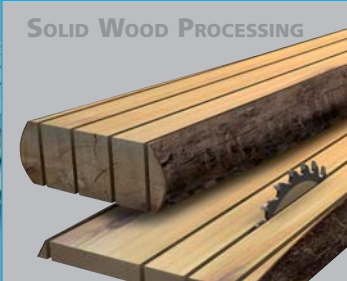
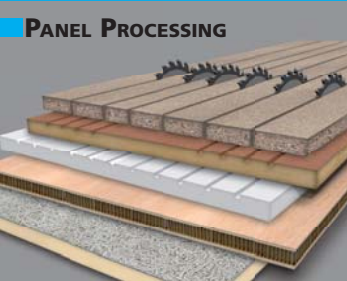

## POSSIBLE APPLICATIONS

### RIPPING OF PANELS

The PAUL Multirip Saws are designed to rip even the widest commercially available panels in a single pass. The machine opening widths range from 800–3000 mm.

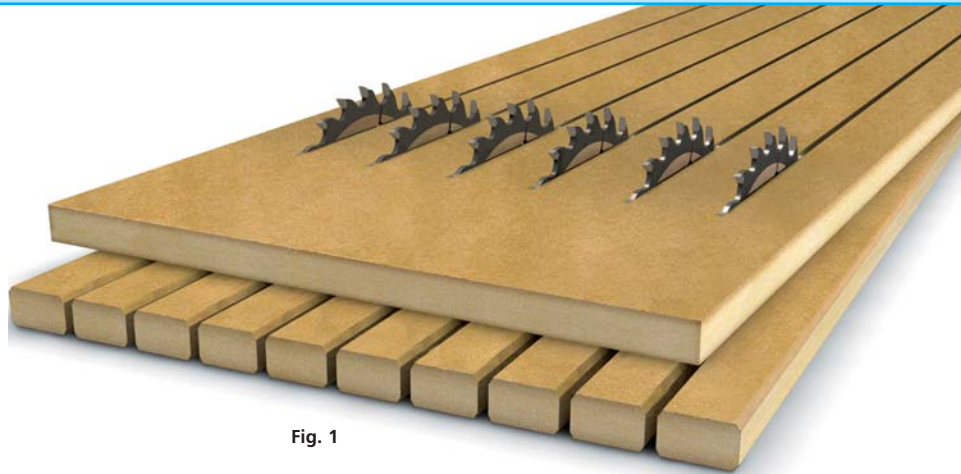

Fig. 1



Fig. 2

They are ideally suited for processing panels of a variety of materials. The spectrum ranges from soft material such as mineral wool to hard CFRP (carbon fibre reinforced plastic) or fibre cement:

- Particle board, paper-coated
- Particle board, veneered
- OSB
- LVL
- MDF
- Glulam
- Wood fiberboard
- Laminate flooring material
- Laminated wood
- Plywood, paper-coated
- Multilayer solid wood
- Multilayer cork
- Lightweight furniture panels
- Corrugated board
- Rigid foam, glass fiber coated
- Rigid foam, aluminium coated
- PVC
- Rigid foam
- Polymer
- Honey-combed plastics
- GFRP
- CFRP
- Fiber cement
- Wood-wool building slabs
- Mineral wool
- etc.



Fig. 3



## GROOVING / PROFILING

PAUL Multirip Saws are also perfectly suitable for grooving and profiling. A great variety of groove shapes are possible.

The panels can be ripped, grooved and/or profiled in one pass.

With a curved arrangement of the feed rollers it is possible for curved panels to be processed into bed slats.

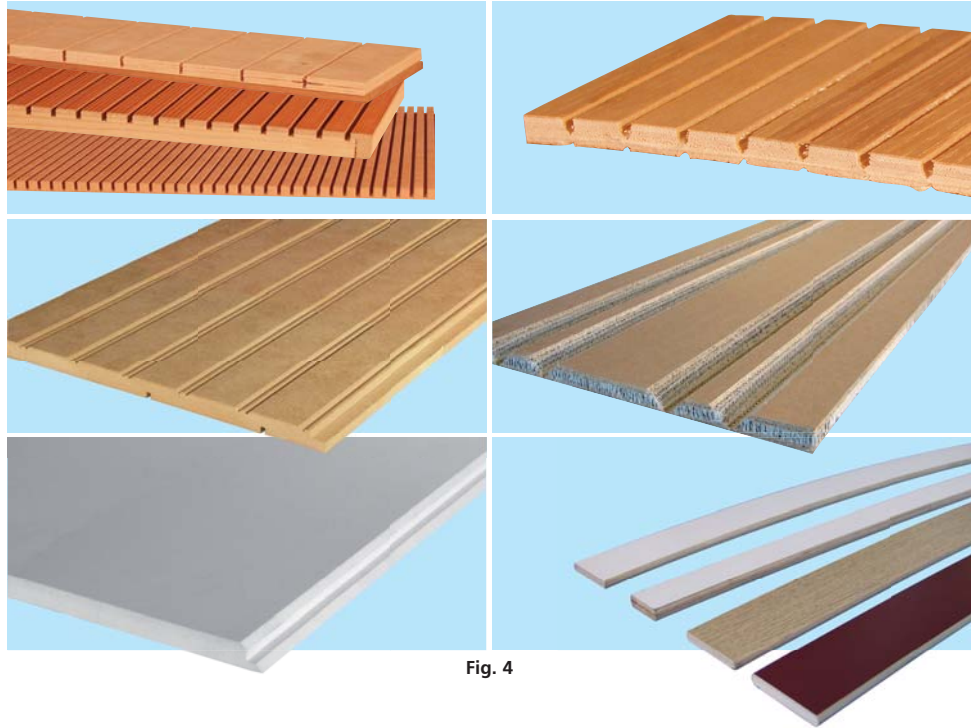

Fig. 4



## EDGING / RIPPING OF SOLID SOFTWOOD AND HARDWOOD



The Multirip Saws from PAUL are also used for the edging and ripping of all kinds of solid-wood boards.

Fig. 5

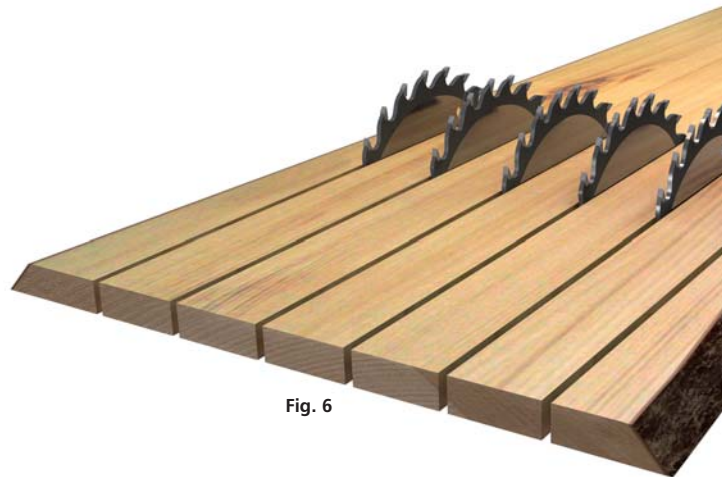

Fig. 6

## MULTIRIP SAWS OF THE K34 SERIES

The unusually large opening widths of the PAUL K34 series of up to 3000 mm meet a wide range of applications.

These machines are meant for use in all fields of the wood-processing industry: in sawmills and in the furniture industry, for the production of parquetry and laminated flooring, pallets, concrete moulds, kitchen front panels, glued up panels, cement-bonded particle boards, profile strips, door skins, in packaging, window, bed and coffin factories and in the plastics industry.

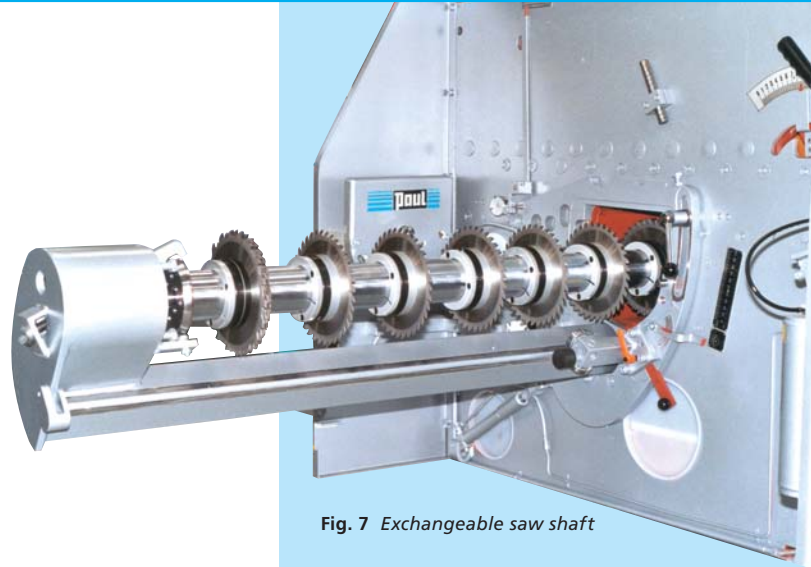

Fig. 7 Exchangeable saw shaft



Fig. 8 Model K34G/800 (opening width 800 mm)

The upward tilting protection hoods with viewing window on the operating side ensure excellent sound and noise emission values. For safety reasons they are interlocked until the saw shaft has come to a standstill.



Fig. 9 Model K34G/3000 (opening width 3000 mm)

# THE SAWING TECHNIQUE

## ▶ INSERT TABLE

All models are equipped with an exchangeable insert table which ensures a positive material support in the area of the saw blades.



**Fig. 10**  
Insert table with  
rip saws and bot-  
tom feed rollers

## ▶ OPERATING PANEL

The clearly arranged operating panel (Fig. 11) incorporates the height adjustment of the top rollers and saw shaft.



**Fig. 11**  
Operating  
panel of a  
K34G

## ▶ HEIGHT ADJUSTMENT OF SAW SHAFT

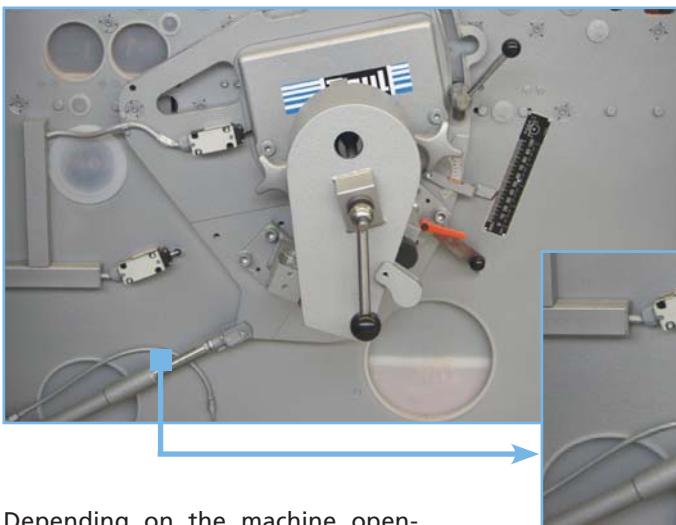

**Fig. 13**  
Height adjustment  
of saw shaft by a  
hydraulic cylinder

Depending on the machine opening width the height adjustment is effected via a hydraulic or electric lifting device (Fig. 12 + 13).

**Fig. 12**  
Height adjustment of saw  
shaft by an electrically  
driven lifting spindle

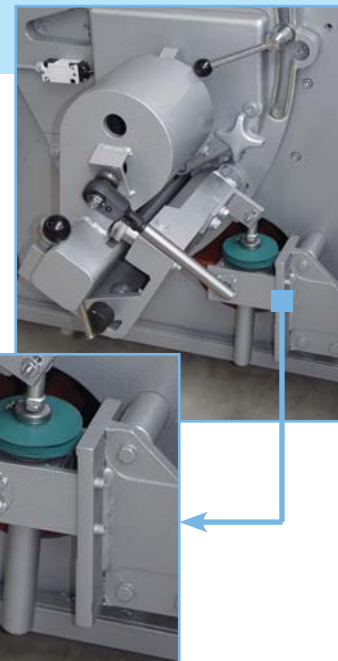

## THE SAW SHAFT TECHNIQUE

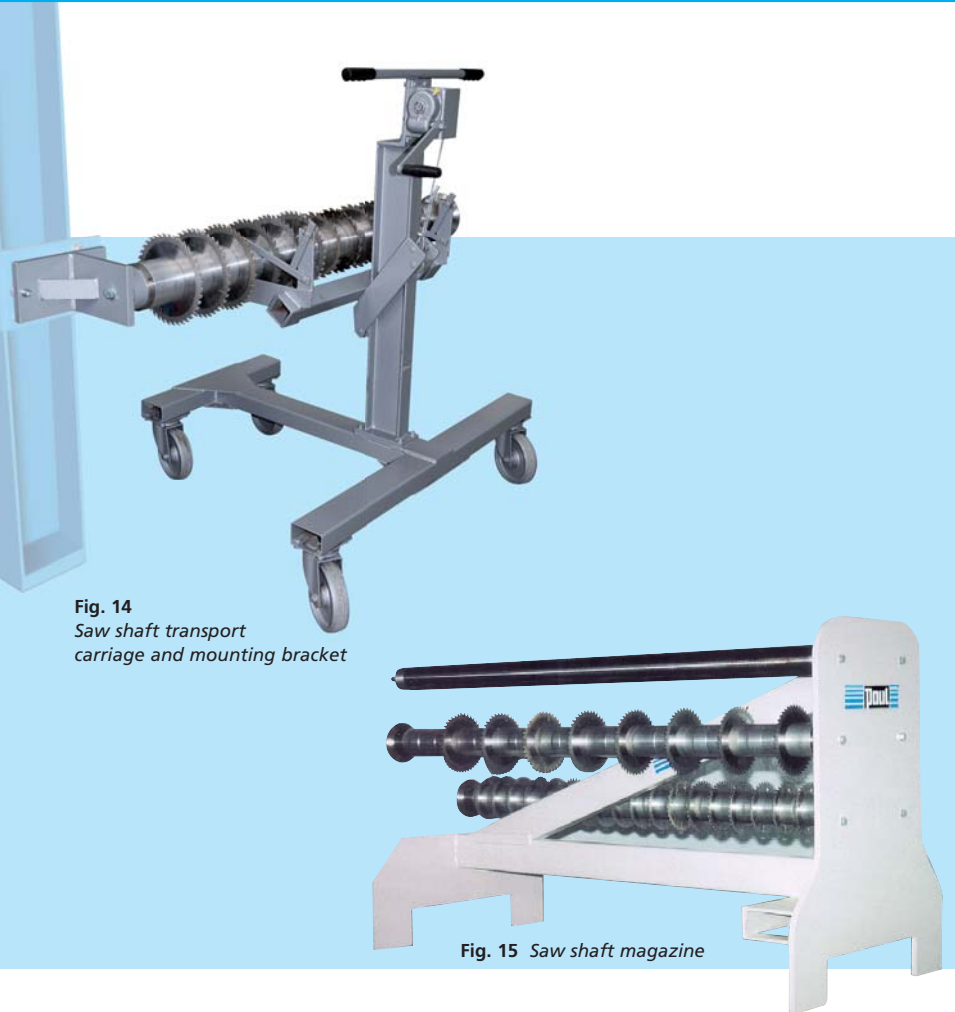

Fig. 14  
Saw shaft transport  
carriage and mounting bracket

Fig. 15 Saw shaft magazine

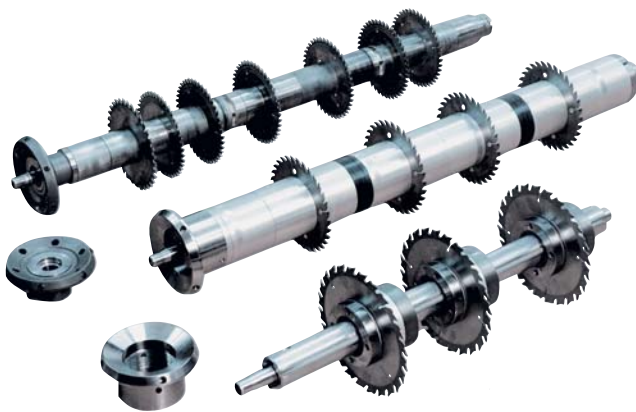

Fig. 16 Saw shaft systems

### The possibilities

- Mechanically tensioned saw shafts of 100 mm in  $\varnothing$  (for all opening widths) or 75 mm in  $\varnothing$  (for opening widths up to 1500 mm) (Fig. 16, middle).
- Hydraulically tensioned shafts of 50 mm in  $\varnothing$  (for opening widths up to 1200 mm) or 60 mm in  $\varnothing$  (for opening widths up to 1500 mm) (Fig. 16, on top) reach the same rigidity by tensioning with a hydraulic nut despite their considerably smaller diameters. Advantage of these shafts: Possibility to handle thicker material.
- Saw shafts of 70 mm in  $\varnothing$  (for opening widths up to 1500 mm) or 100 mm in  $\varnothing$  (opening widths up to 3000 mm) using individually adjustable saw bushes (mechanical or hydraulic design, Fig. 16, bottom) are especially suitable where only a few saw blades are required, i.e. from a strip width of approx. 50 mm upwards. The manually adjustable saw bushes are fitted with one saw blade or hogger each.



Fig. 17 Spacer rings

Tooling of the saw shaft is effected outside the machine. For this purpose the shaft can be demounted and mounted by only one man. The transport carriage (Fig. 14) provides ease of handling so that even

long shafts can be entered into the machine without difficulty.

Single saw shafts can be stored and tooled by using a mounting bracket (Fig. 14). For storing several saw

shafts a shaft magazine (Fig. 15) is recommended.

By combining intermediate spacer rings that are available in thicknesses from 0.1 to 100 mm (Fig. 17), any saw spacing required can be obtained.

# THE FEED SYSTEM



## FEED ROLLERS

One of the reasons for the multitude of applications offered by the K34 series is their feed system that is available with feed rollers in various designs (e.g. knurled, fluted or plastic-coated) to provide a tailor-made solution to any requirement.

Bottom and/or top brush rollers are available as an option.

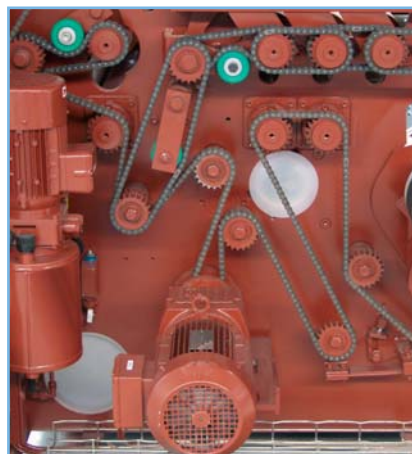

**Fig. 18**  
Feed rollers in various designs



## FEED DRIVE

Drive is provided by an infinitely variable, frequency-controlled gear motor. The feed rollers are driven either via high-strength chains or cardan shafts.



**Fig. 19** Feed drive via chains



**Fig. 20** Drive of feed rollers via cardan shafts

# SINGLE-SHAFT MODELS

## K34 / K34G / K34GX

This multirip saw series is available in three different basic models:

- K34
- K34G
- K34GX

The most important criteria for the selection of the basic model are:

- Maximum workpiece thickness
- Minimum workpiece length

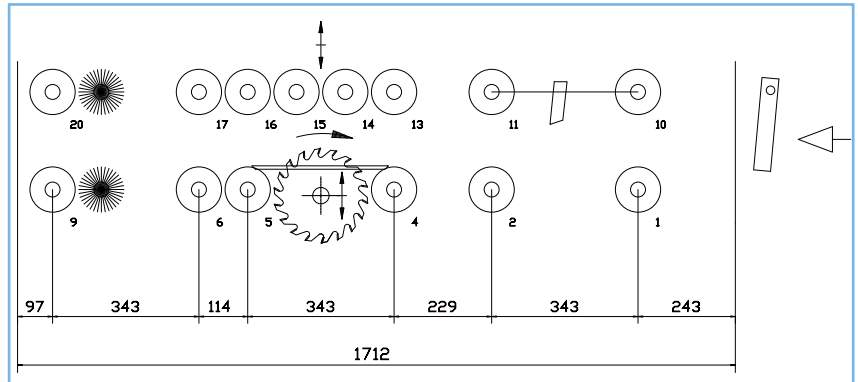

Fig. 21 Schematic view of K34 with special anti-kickback device

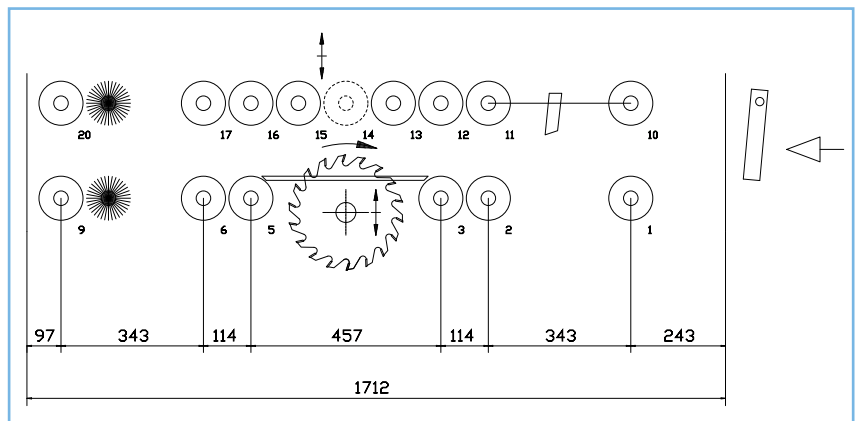

Fig. 22 Schematic view of K34G with special anti-kickback device

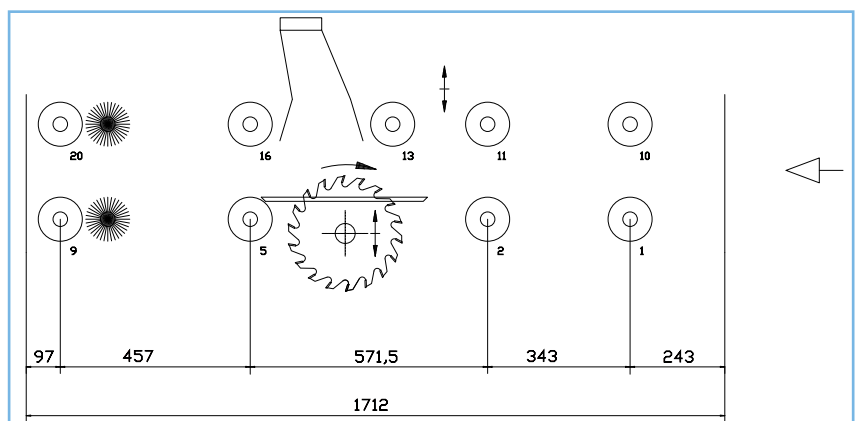

Fig. 23 Schematic view of K34GX without anti-kickback device





## K34 / K34G / K34GX

Model	K34	K34G	K34GX
Minimum workpiece length <sup>1)</sup>	350 mm	460 mm	1050 mm
Maximum workpiece thickness <sup>2)</sup>	75 mm	95 mm	95 mm

- 1) Subject to max. workpiece thickness  
Shorter workpiece lengths possible,  
depending on the application concerned
- 2) Subject to machine width and min. workpiece length



Fig. 24 Model K34G



## K34G-O

This machine is equipped with an overhead saw shaft designed for ripping, grooving and profiling from the top.

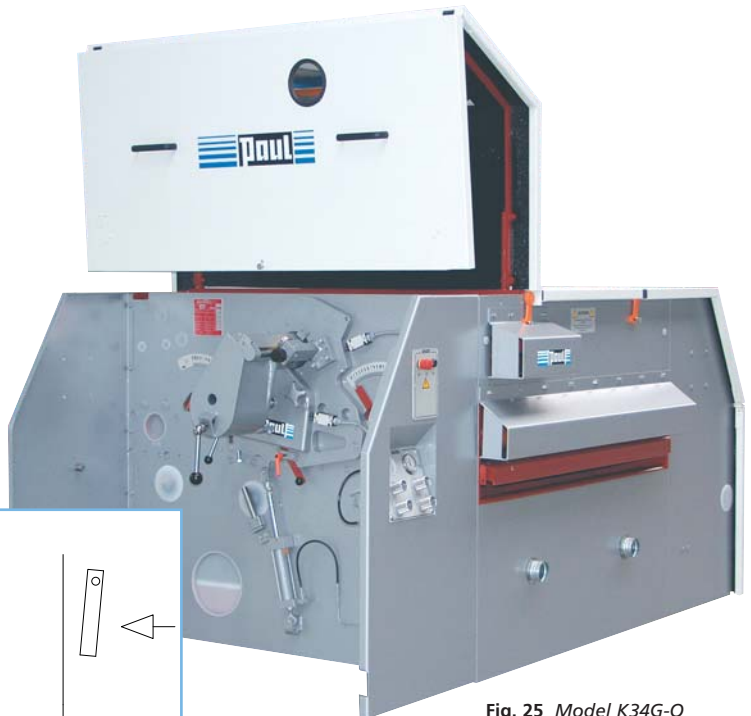

Fig. 25 Model K34G-O

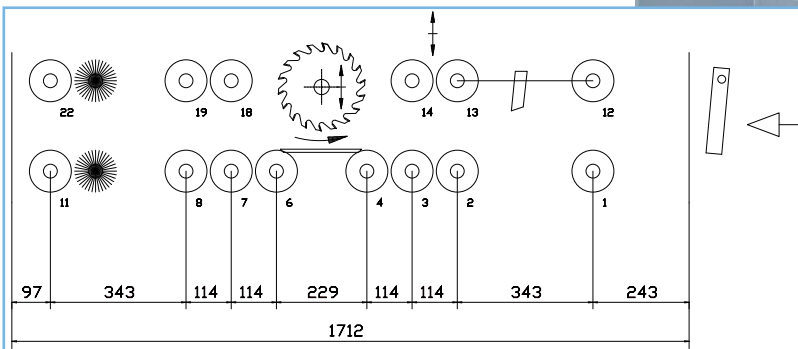

Fig. 26 Schematic view of K34G-O with special anti-kickback device

## DOUBLE-SHAFT MODELS

### K34G-UU

The machines of this series are equipped with two bottom saw shafts arranged one after the other. The two shafts can be used either simultaneously or in rotation.

In cases where a quick change of the cutting program is required, it is possible to change from one shaft to the other within a few seconds.



Fig. 27 Model K34G-UU

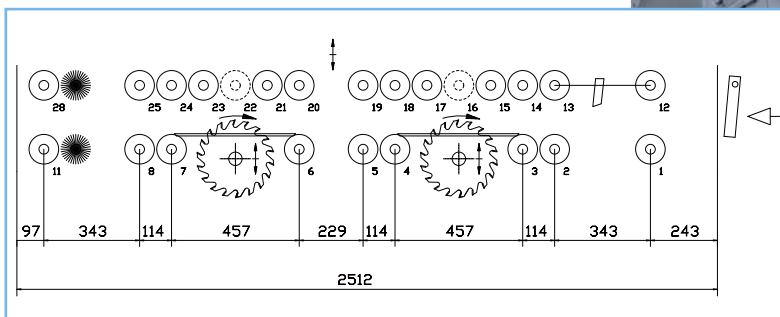

Fig. 28 Schematic view of K34G-UU with special anti-kickback device

### K34G-OU

Model K34G-OU is suitable for ripping, grooving and profiling.

The machine features a top and a bottom saw shaft arranged one after the other and allows processing both the top and bottom face of a panel in a single pass.



Fig. 29 Model K34G-OU

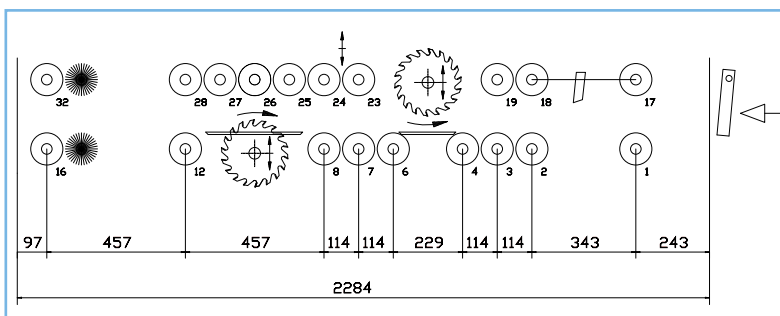

Fig. 30 Schematic view of K34G-OU with special anti-kickback device

## MACHINES WITH MOVING SAWS FOR PANELS

### ▶ K34M / K34MV

These multirip saws are suitable for all common panel formats. By adding any number of saw modules with 1 or 2 CNC-controlled saw heads each, the panels can be ripped into any number of strips of whatever width.

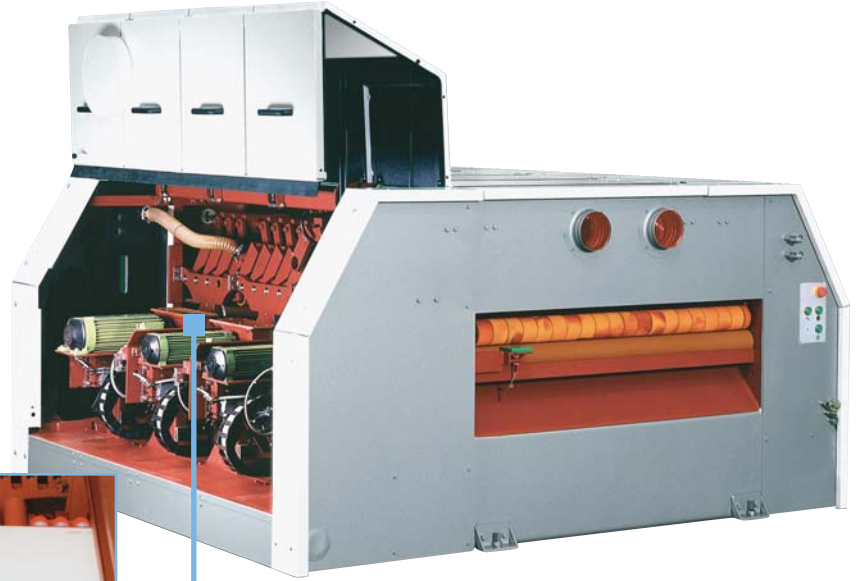

Fig. 31 Model K34M

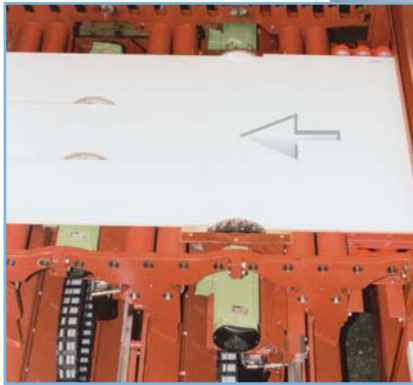

Fig. 32 Model K34M with typical configuration of hogger and rip saw heads in operation (shown without top rollers). Scoring saws available as an option

For more details, see PAUL brochure B 116.40/1

### ▶ K34VARIO

The independent saw heads arranged side by side can be individually positioned via the CNC control with almost no interruption of the material flow. Upstream hogger units, also movable, will hog any remaining strips.

Minimum strip width 185 mm (standard) or 95 mm (optional).



Fig. 33 Model K34VARIO



Fig. 34 Lowerable saw heads

For more details, see PAUL brochure B 116.41/1

## TECHNICAL DATA

	K34	K34G / K34GX	K34G-O
Nominal opening width	800   1200   1500   1800 2200   2600   3000 mm	800   1200   1500   1800 2200   2600   3000 mm	800   1200   1500   1800 2200   2600   3000 mm
Max. workpiece thickness <sup>1)</sup> with insert table	55   50   40   30 mm	85   80   70   60 mm	45 mm
Tool shaft diameter	50   60   75   100 mm	50   60   75   100 mm	50   60   75   100 mm
Max. tool diameter <sup>2)</sup>	210 mm	270 mm	250 mm
Tool clamping width	Opening width minus 110 mm	Opening width minus 110 mm	Opening width minus 110 mm
No. of hydr. vertically adjustable top rollers	8	8 <sup>10)</sup> /5	5 + 1
Powered bottom rollers	5	5 <sup>10)</sup> /4	8
Idle bottom rollers	1	1 <sup>10)</sup> /–	–
Roller drive	Chain/Cardan	Chain/Cardan	Cardan
Length of top rollers	Opening width minus 58 mm	Opening width minus 58 mm	Opening width minus 58 mm
Length of bottom rollers	Opening width minus 16 mm	Opening width minus 16 mm	Opening width minus 16 mm
Feed speed <sup>3)4)</sup> frequency-controlled	15 - 50 m/min	15 - 50 m/min	15 - 50 m/min
Feed motor power <sup>4)</sup>	2.2 kW	2.2 kW	2.2 kW
Max. working speed at max. saw blade dia.	50 m/sec	64 m/sec	64 m/sec
Min. workpiece length <sup>5)</sup>	from 350 mm	from 460 mm <sup>10)</sup> /1050 mm	from 460 mm
Max. driving power	90 kW (4500 rpm)	90 kW (4500 rpm)	90 kW (4500 rpm)
Sound pressure level <sup>6)</sup> at no-load/in operation	75/82 dB(A)	75/82 dB(A)	75/82 dB(A)
Sound power level <sup>7)</sup> at no-load/in operation	91/98 dB(A)	91/98 dB(A)	91/98 dB(A)
<b>Dimensions:</b>			
Working height <sup>1)</sup>	800 mm	800 mm	800 mm
Length/height, appr.	1813 mm / 1430 mm	1813 mm / 1430 mm	1813 mm / 1430 mm
Width, appr.	2040   2440   2740   3040   3440   3840   4240 mm	2040   2440   2740   3040   3440   3840   4240 mm	2240   2640   2940   3240   3640   4040   4440 mm
Width from 55 kW, appr.	2650   3050   3350   3650   4050   4450   4850 mm	2650   3050   3350   3650   4050   4450   4850 mm	2850   3250   3550   3850   4250   4650   5050 mm
Weight, appr. <sup>8)9)</sup>	2750   3200   3800   4300   5000   5700   6300 kg	2750   3200   3800   4300   5000   5700   6300 kg	2750   3200   3800   4300   5000   5700   6300 kg

1) See table "Workpiece thickness" on page 13

2) The maximum tool diameter depends on the design/equipment of the machine and type of tools used.  
Before ordering any tools, please seek our advice on the exact technical specification.

3) With manual workpiece removal max. 35 m/min

4) Other versions on inquiry

5) Shorter workpiece lengths possible, depending on the application concerned

6) At the workplace, depending on tool and cutting parameters

7) Depending on tool and cutting parameters

8) Weight incl. 30 kW motor, excluding special accessories. Where an optional chain or cardan drive is available,  
the weight indicated applies to the chain version (extra weight for cardan: appr. 200 kg)

9) K34GX appr. 10% lower in weight than K34G

10) Applies to K34G

11) Increased sound emission to be expected when using 2 saw shafts simultaneously

12) Applies to K34MV

K34G-UU	K34G-OU	K34M / K34MV	K34VARIO
800   1200   1500   1800 2200   2600   3000 mm	800   1200   1500   1800 2200   2600   3000 mm	800   1200   1500   1800 2200   2600   3000 mm	800   1200   1500   1800 2200   2600   3000 mm
85   80   70   60 mm	85   80   70   60 mm	80 mm	20 <sup>4)</sup> mm
50   60   75   100 mm	50   60   75   100 mm	–	–
270 mm	250 mm	300 mm	270 mm
Opening width minus 110 mm	Opening width minus 110 mm	–	–
13	8 + 1	depending on configuration	depending on configuration
7	8	–	depending on configuration
2	1	depending on configuration	–
Cardan	Cardan	Chain	Cardan
Opening width minus 58 mm	Opening width minus 58 mm	Opening width minus 58 mm	Opening width minus 58 mm
Opening width minus 16 mm	Opening width minus 16 mm	Opening width minus 16 mm	Opening width minus 16 mm
15 - 50 m/min	15 - 50 m/min	15 - 50 m/min	15 - 50 m/min
2.2 kW	2.2 kW	5.5 kW	2.2 kW
64 m/sec	64 m/sec	94 m/sec	84 m/sec
from 460 mm	from 460 mm	from 580 mm/690 mm <sup>12)</sup>	from 460 mm
90 kW (4500 rpm)	90 kW (4500 rpm)	14.5 kW (6000 rpm) per tool head	8.5 kW (4500 rpm) <sup>4)</sup> per tool head
75/82 dB(A) <sup>11)</sup>	75/82 dB(A) <sup>11)</sup>	75/82 dB(A)	75/82 dB(A)
91/98 dB(A) <sup>11)</sup>	91/98 dB(A) <sup>11)</sup>	91/98 dB(A)	91/98 dB(A)
800 mm	800 mm	800 mm	1 100 mm
2612 mm / 1430 mm	2384 mm/1430 mm	dep. on config./1430 mm	1813 mm/2000 mm
2040   2440   2740   3040 3440   3840   4240 mm	2240   2640   2940   3240 3640   4040   4440 mm	2110   2510   2810   3110 3510   3810   4310 mm	depending on configuration
2650   3050   3350   3650 4050   4450   4850 mm	2850   3250   3550   3850 4250   4650   5050 mm	–	–
6700   7100   7400   7700 8100   8500   9200 kg	6600   7000   7300   7600 8000   8400   9100 kg	depending on configuration	depending on configuration

#### Workpiece thickness

Tool shaft Ø (mm)	Feather keys	Saw bush Ø (mm)	Outside Ø of spacer rings (mm)	Max. workpiece thickness in mm with a tool Ø of:			
				with insert table		without insert table	
				K34 Ø 210 mm	K34G / K34GX Ø 270 mm	K34 Ø 230 mm	K34G / K34GX Ø 270 mm
50	–	–	70	55	85	75	95
60	–	–	80	55	80	70	90
70	–	100	–	40	70	60	80
75	2	–	100	40	70	60	80
100	2	–	120	30	60	50	70
100	–	140	–	20	50	40	60

# COMPLETE CUSTOMIZED RIP AND CROSS-CUT SYSTEMS

PAUL not only supply stand alone machines, but also complete, customized high-volume systems for panels and solid wood. The degree of automation is suited to the application concerned, ranging from partial automation to the fully automatic high-end solution.

PAUL multirip saws are ideally suitable for incorporation into through-feed panel sizing lines. They can be used for both longitudinal and transverse ripping operations. The feeding systems available range from the simple solution using an inclined roller conveyor with fence up to the fully automatic, highly efficient alignment station where each workpiece is aligned by means of cameras and image processing.

Automatic panel rip and cross-cut system for furniture components (fig. 35 to 37)



Fig. 35 Vacuum gantry stacker for stacking the strips leaving a K34G/2200 multirip saw with automatic infeed system

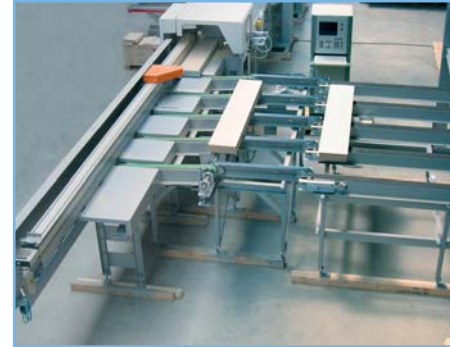

Fig. 36 Length cutting on a CNC cross-cut system



Fig. 37 Length-sorted stacking of cross-cut workpieces on pallets

Stacking system

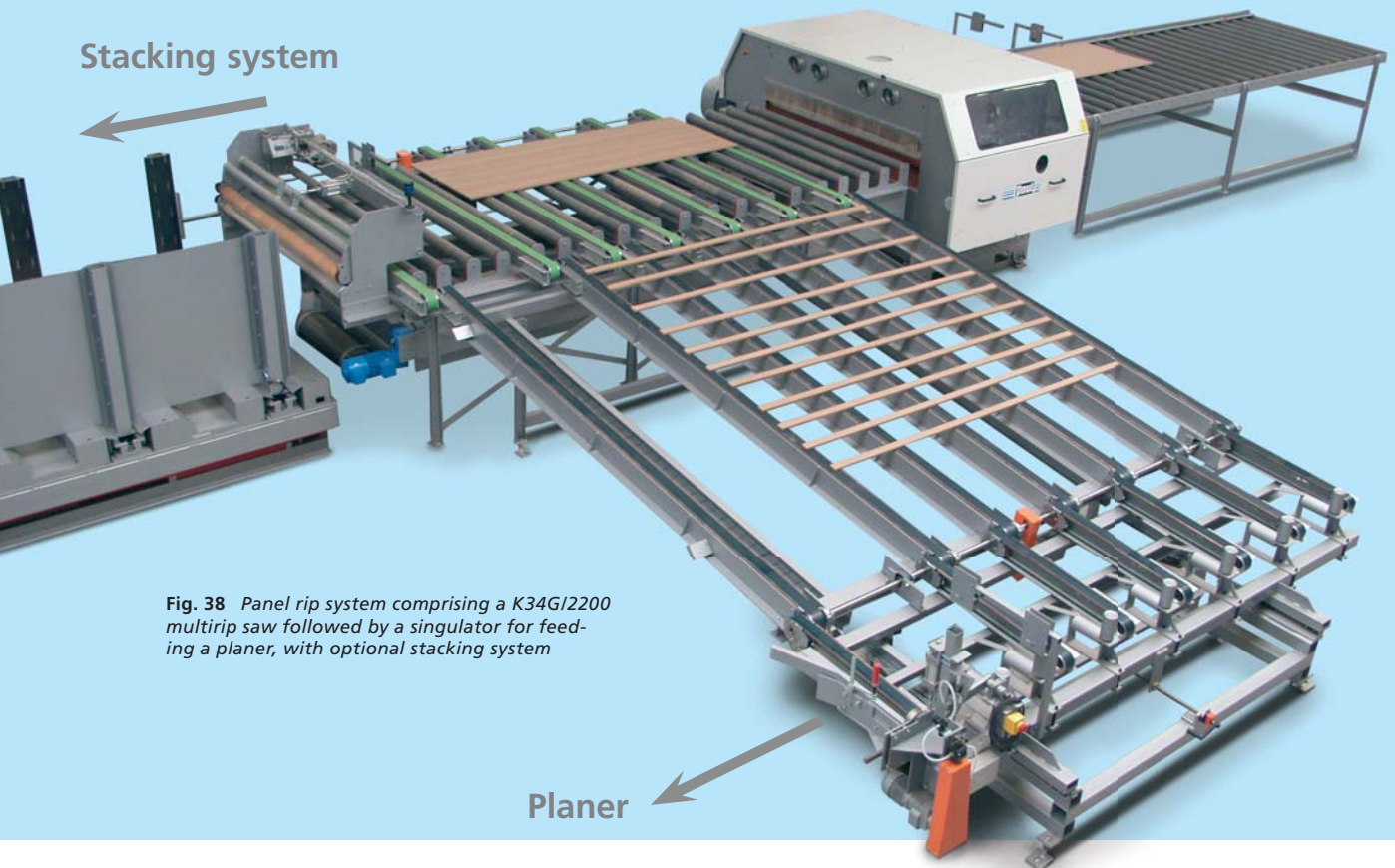
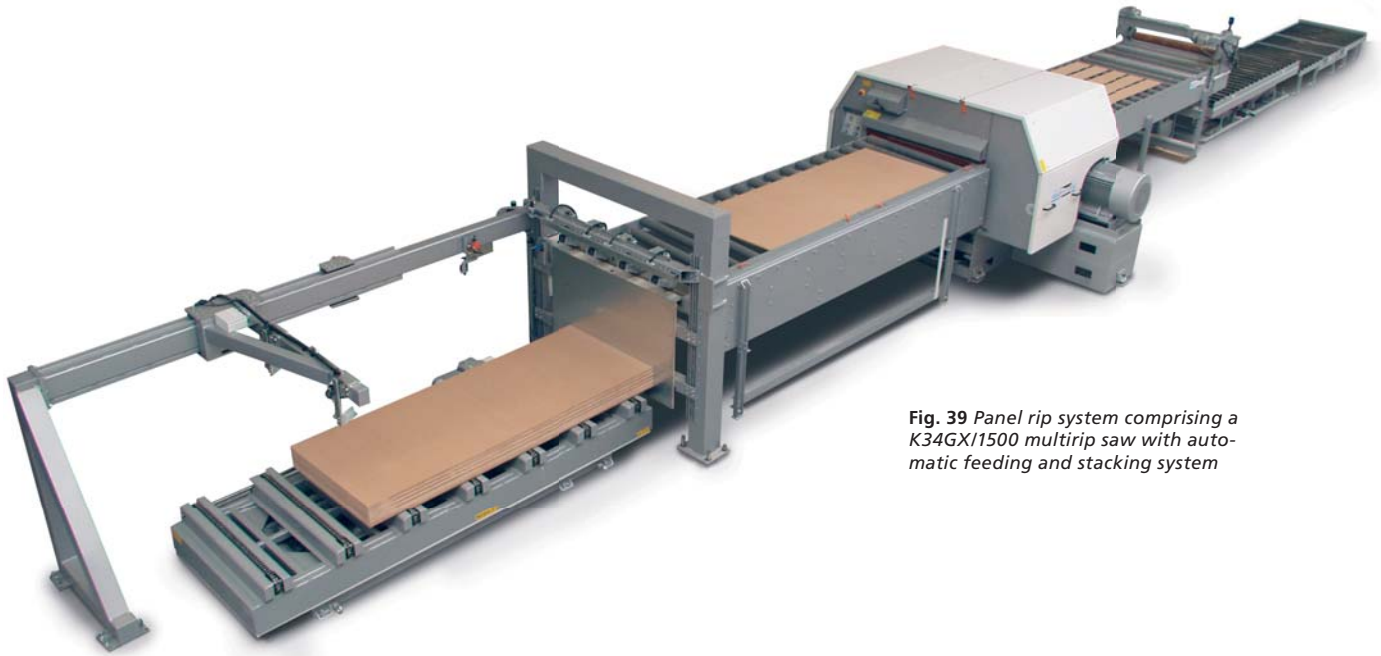

Fig. 38 Panel rip system comprising a K34G/2200 multirip saw followed by a singulator for feeding a planer, with optional stacking system

Planer

## FOR PANELS



*Fig. 39 Panel rip system comprising a K34GX/1500 multirip saw with automatic feeding and stacking system*



*Fig. 40 Panel rip system comprising a K34VARIO/2600 multirip saw, incl. automatic vacuum destacker used in the plastics industry*

# COMPLETE CUSTOMIZED RIP AND CROSS-CUT SYSTEMS FOR SOLID WOOD

In the solid wood sector PAUL multi-rip saws offer a variety of applications, primarily in the secondary wood processing industries. Partial or fully automatic feeding systems ensure that their high capacity is fully utilized. The edging and ripping machines are designed for incorporation into production lines.

Starting from destacking, via pre-cross-cutting (where applicable), to the automatically loaded multirip saw and further to cross-cut systems with crayon-marked or automatic defect recognition and automatic sorting and stacking systems PAUL offer everything as a single-source supplier.



Fig. 41 Rip system used in the production of top layer components of finished parquetry, composed of a K34G/800 multirip saw in special design with moving saw and ...



Fig. 42 ... an automatically linked CNC cross-cut system

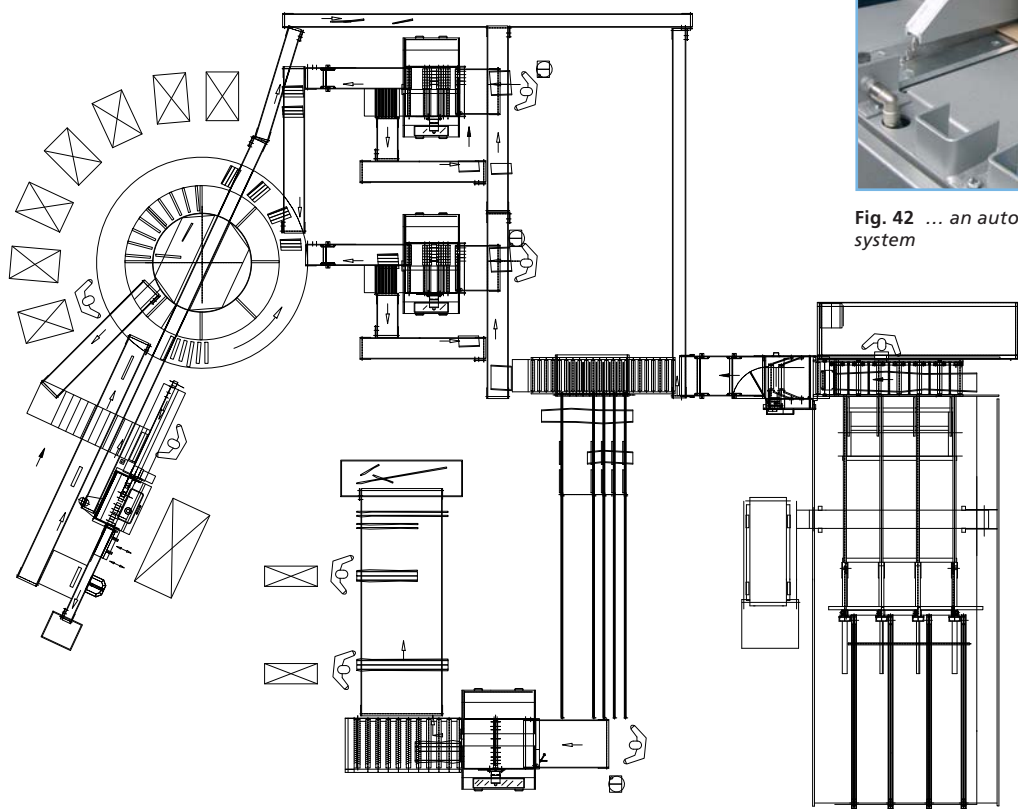

Fig. 43 Rip and cross-cut system for solid parquetry (battens, flooring planks) incl. pre-cross-cutting, ripping, cutting to final length and sorting carousel