

edge banders, sizing edge banders

# stefani top

edge banders and sizing edge banders for the furniture industry



# stefani top

Edge banders – Sizing edge banders



## **UNDISPUTED LEADER**

Decades of SCM know-how in solutions for the squaring-edgebanding of the panel and thousands of machines installed worldwide are summarized in the Stefani TOP range that represents the highest expression and reference in the market for this type of technology.

## **UNLIMITED POSSIBILITIES**

Adapting to the changing reality and production targets is the point of force that characterizes the Stefani TOP range, that in all conditions is able to guarantee the strength of a perfect product.

## **BUSINESS DEVELOPMENT**

History and future meet together in a unique and unmistakable structural design. Reliability and efficiency are absolute and guaranteed. The technical level of the latest generation and the high-end performance without doubt make the Stefani TOP range, the right choice for the development of your production and your business.



Production levels from 1 to thousands of panels per batch.



Continuous production also with lengths and widths that are always different.



Perfect machinability even with the most advanced and modern materials.



Possibility to control design quality and production costs of the joint between panel and edge in the processes with or without glue.

# stefani top

Edge banders – Sizing edge banders







# stefani top

Edge banders – Sizing edge banders

## CREATIVITY WITHOUT LIMITS

It is easy and immediate to produce modern furniture with materials and finishes of the new generation with the Stefani TOP range which helps always and under all conditions to reach the most current design trends.



PAPER/MELAMINE



PVC/ABS  
PP



0.6/0.8 MM STRIPS  
VENEER  
FORMICA/HPL/UNICOLOR



MAX 25 MM  
SOLID WOOD

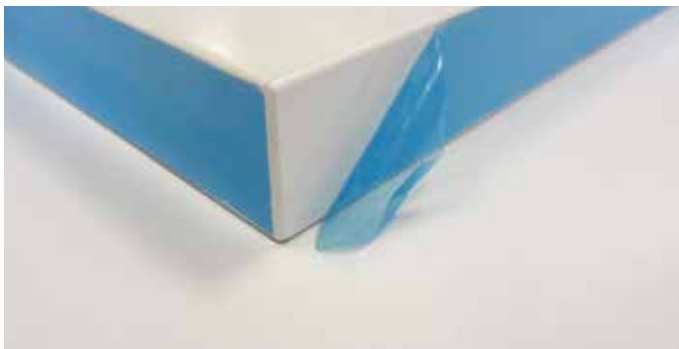

PANELS/EDGES WITH PROTECTIVE FILM



NESTING



DUST-PROOF EDGE



GLOSS EDGES/GLOSS PANELS

## RANGE

### STEFANI ONE - TWO

#### Edge bander

Ideal for the production of medium / high volumes of panels with door/softforming/evolved softforming processes.



	COMPOSITION	1 SIDE 1 PASS PROCESSING	2 SIDES 1 PASS PROCESSING	ARCHITECTURE
<b>stefani one</b>	1 beam	Yes	No	Single side
<b>stefani two</b>	2 beams	No	Yes	Double side

### STEFANI SB ONE

#### Single side sizing edge bander

Ideal for the production of medium/high volumes of batches with mainly heterogeneous sizes.



### STEFANI SSB - SB - 60

#### Double side sizing edge bander

Ideal for the production of high and very high volumes, of batches with predominantly repetitive sizes.



	COMPOSITION	ONLY 1ST PASS PROCESSING VERSION	ONLY 2ND PASS PROCESSING VERSION	1ST+2ND PASS PROCESSING VERSION
<b>stefani ssb</b>	2 beams	Yes	Yes	Yes
<b>stefani sb</b>	2 beams	Yes	Yes	Yes
<b>stefani 60</b>	2 beams in succession	Yes	No	No

# stefani top

Edge banders – Sizing edge banders

## MASS PRODUCTION

The Stefani TOP range is ready for projects where short delivery times and high production volumes meet and are essential for business growth.

In these conditions, one or more machines can be easily integrated with each other and with the appropriate handling equipment to decrease production times.

## HALF LINE

For large production volumes.

It allows the automatic loading of panels, the first longitudinal machining, the automatic unloading, the handling of stacks towards the load zone and the subsequent second transversal machining of the panel always with automatic loading and unloading.

Consisting of:

- Loading cell with two pickup stations
- Sizing edge bander for the first and second pass
- Unloading cell with two unloading stations
- Supervision by "zone" management of the line for time reduction at any size changes

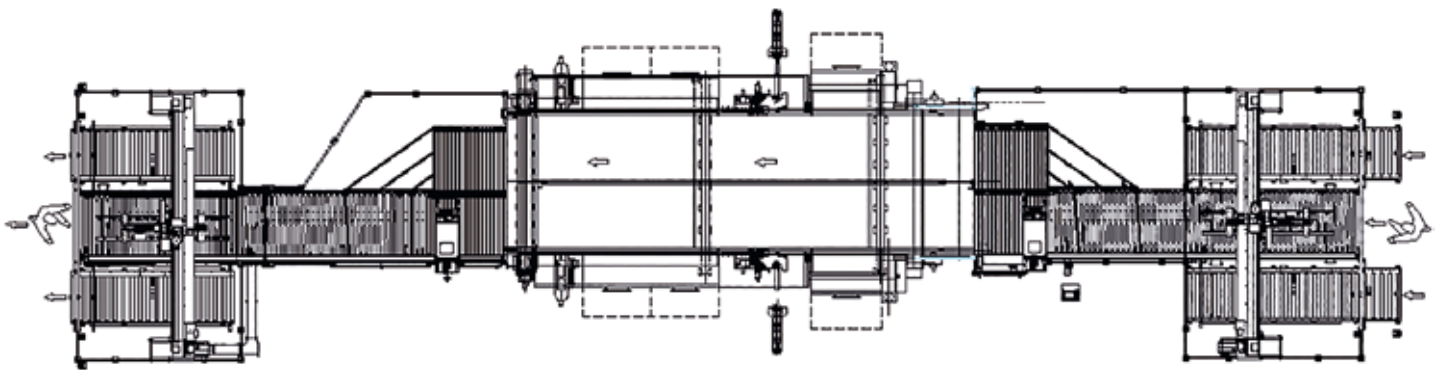

## COMPLETE LINE

For very large production volumes.

It provides for the automatic loading of the panels, the first longitudinal machining, the 90° rotation of the panel in preparation to the second machine, the subsequent second transversal machining, the automatic unloading. Compared to the half line, the complete line avoids wasted time for repositioning of the stacks in the loading zone for the completion of the process.

Consisting of:

- Loading cell with two pickup stations
- Sizing edge bander for the first pass
- Panel rotator
- Sizing edge bander for the second pass
- Unloading cell with two unloading stations
- Supervision by "zone" management of the line for time reduction at any size changes

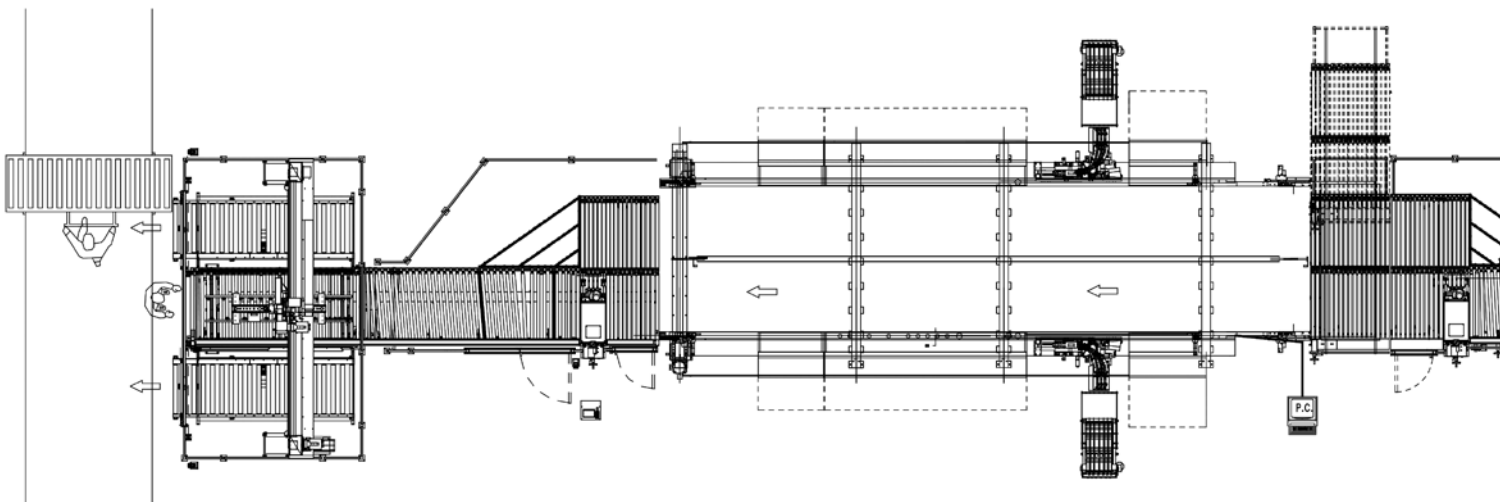



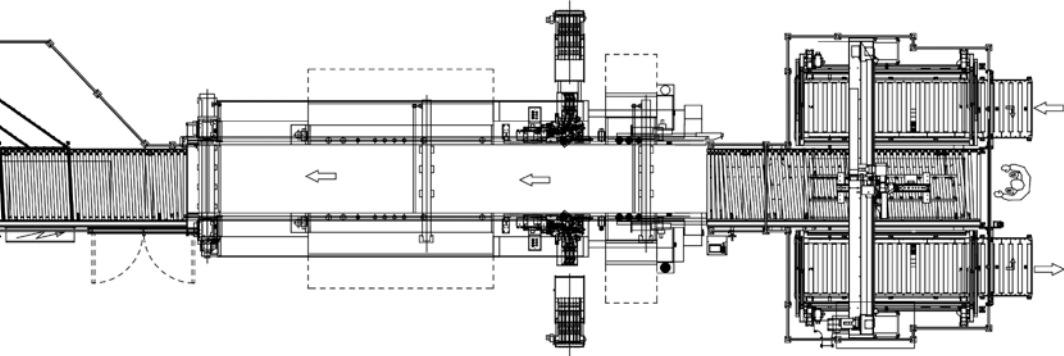

# stefani top

Edge banders – Sizing edge banders

## WEB TO ORDER: PRODUCTION IN SMALL SERIES

To produce with the philosophy “Web to Order” is fast and easy with solutions of Stefani TOP dedicated to the small and discontinuous series. The need to produce in a few hours from the order, even a single piece of furniture, find the right solution thanks to the edge banding cell based on maximum versatility and integration into the production flow.

## MEDIUM SMALL BATCHES

For small and medium batches and always variables panel sizes. Overall dimensions 300/350 m<sup>2</sup>.

It provides for the loading and unloading of the panels with 2 operators, 2 passes within the cell to complete the sizing and edge banding of the panel.

Consisting of:

- Accessories for the loading
- Introduction system for first and second pass
- Single side sizing edge bander **stefani sb one**
- Handling equipment for the return
- Introduction system for first and second pass with a device for the panel sizing
- Second single-side sizing edge bander **stefani sb one**
- Accessories for unloading
- Supervisory system from a single point

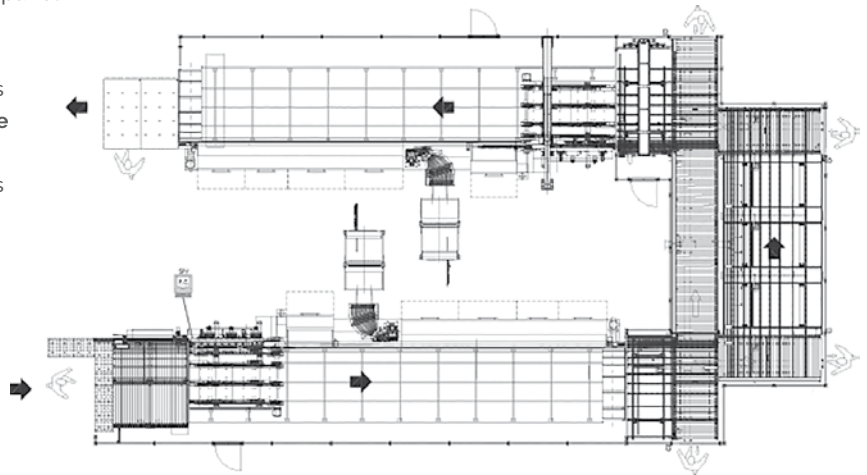

## BATCH 1

For the single panel and up to batches with more panels with dimensions and quantity always variable. Overall dimensions from 80 to 250 m<sup>2</sup>.

It provides for the loading and unloading of the panels with one operator always positioned at the same point, 4 steps within the cell to complete the sizing and edge banding of the panel.

Consisting of:

- Accessories for the loading
- Feeding system and sizing of the panel
- Single-side edge banders **stefani s o stefani one/sb one**
- Handling of panel return to the operator
- Supervisory system from a single point

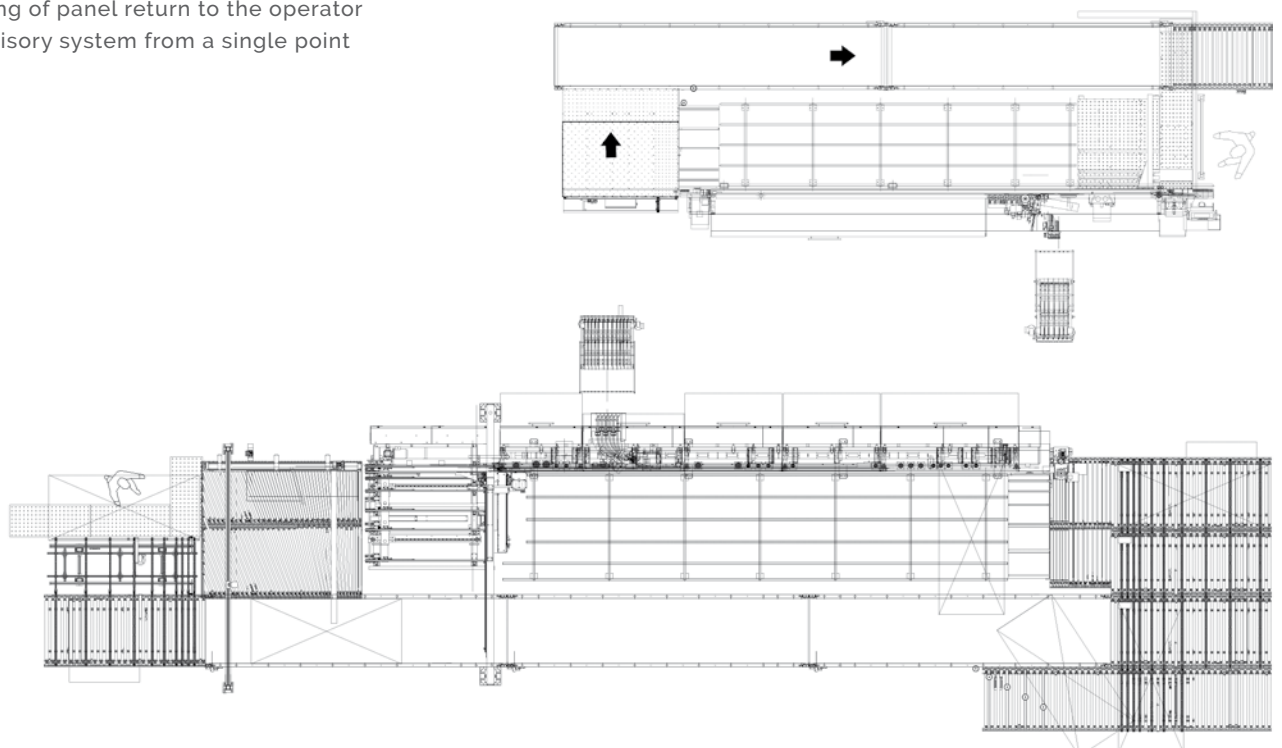



**ORDER BY ORDER**

For the single panel and up to batches with more panels with dimensions and quantity always variable. Overall dimensions 300 m2. It provides for the automatic loading and unloading of panels, 4 passages in the cell to complete the sizing and edgbanding of the panel.

Consisting of:

- Loading cell
- Feeding system and sizing of the panel
- Single-sided sizing and edge bander **stefani sb one**
- Handling of panel return to the operator
- Supervisor system from a single point

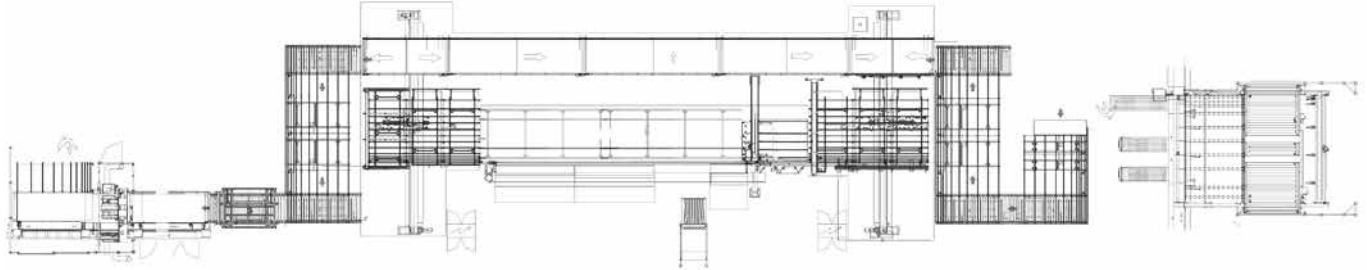



# stefani top

Edge banders – Sizing edge banders

## HOW TO GET A PERFECT PANEL

The goal is to work the components for the furniture with high quality. That is possible with Stefani TOP range thanks to a structural design studied meticulously in every part.



The basements are assembled in a closed box structure with steel elements with very high torsional stiffness.

The columns are made of spheroidal cast iron and have a special and exclusive bracing design to better manage intensive processing.

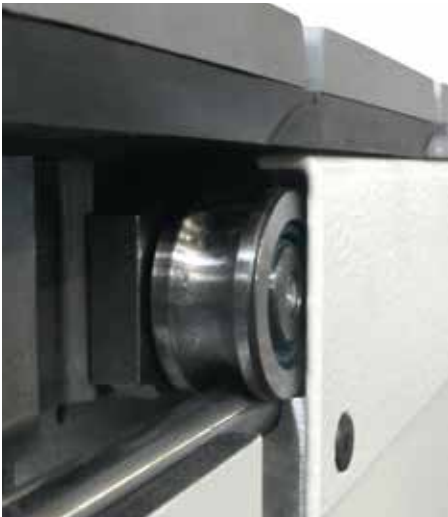

The sliding of the panel, precise and constant over the years is carried out on link chains of sintered isotropic material and on roller bearings at very high precision which move on guides with a non-deformable irremovable coupling. The extreme reliability of this solution, recognized by the market, allows very long maintenance intervals and with very low costs.

The chain link is made with the same technology with which tools are built to guarantee an incredible durability and resistance to stress.



The movement of the chain is carried out with a special pinion which resists vibrations at speeds up to 70 m/min.

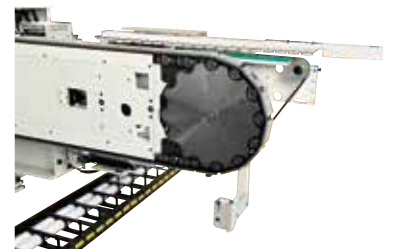

Extremely precise machine set-up with the opening of the beams thanks to perfect combination of rack screws and recirculating ball screws to cancel backlash.





Infinite range of application, with basement designed to process from narrow components for drawers, 60 mm wide, up to the sides for long cabinets, 3,700 mm long.

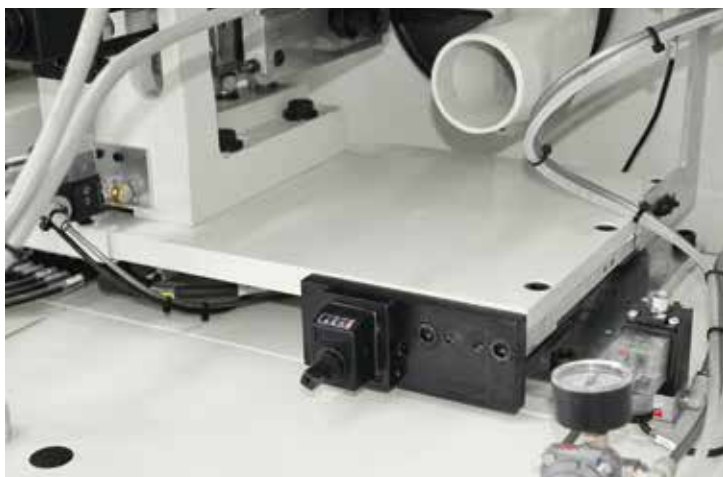

Versatility in the processing of grooves, complex design in soft-forming or post-forming process, are possible with the manual or automatic adjustment of the working line up to 90 mm.



Fluid and precise panel movement thanks to the pressure belt supported by a solid pressure in non-deformable steel.



The upper belt is motorized (**stefani sb**) to ensure the best transport conditions even in the case of large and heavy panels. The vertical movement of the pressure device is automatically managed by the NC according to the panel thickness.

# stefani top

Edge banders – Sizing edge banders

## PANEL INFEED

The correct panel infeed is essential to comply with the shape and final size of the component. The Stefani TOP range includes a large know-how and numerous solutions for the perfect introduction of the panel in any condition.

## SINGLE SIDED MACHINES

Middle high productivity

Automatic infeed device by belts with dynamic movement of dogs for the longitudinal and transversal insertion.



Versions available for:

- panels already sized and squared (coming from beam saw/end tenoners/machining centers)
- panels to be sized and squared with overhead reference guide on right side.

High productivity.

Automatic infeed device by chains with dogs for the longitudinal and transversal insertion.

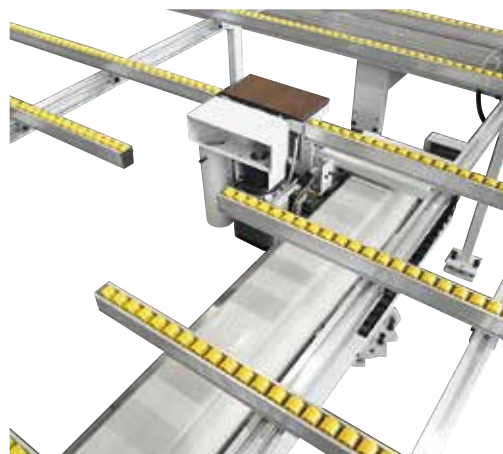

Version for panels already sized and squared (coming from beam saw/end tenoners/machining centers).

External milling unit for panel squaring and sizing.





# stefani top

Edge banders – Sizing edge banders

## DOUBLE SIDED MACHINES

Longitudinal introduction



Approach system to the entry guide for machines in the version for only longitudinal pass machining.



Approach system to the entry guide for machines in the version for longitudinal + transversal pass machining.

Transversal introduction



Lifting and waiting system of dogs with more sectors that allow to maximize productivity with each panel size.



Double dog system for the precise and constant transport of the panel along the entire machine for the transversal processing. To ensure the maximum possible production with each panel size, the dog pitch can be chosen among: 900 mm, 500 mm, 400 mm, 300 mm. Dogs are adjusted automatically in height.

Specific dogs for delicate materials or for high speeds.







# stefani top

Edge banders – Sizing edge banders

## PREPARATION AND SIZING OF PANEL

Sizing, squaring and preparation of the surface finish before the gluing are the objectives of the panel preparation working units, to always create the best conditions for a perfect junction quality.

## PREMILLING UNITS

The vertical arrangement of the tools provides excellent squaring and sizing of the panel with a high degree of finishing / smoothing of the raw panel.

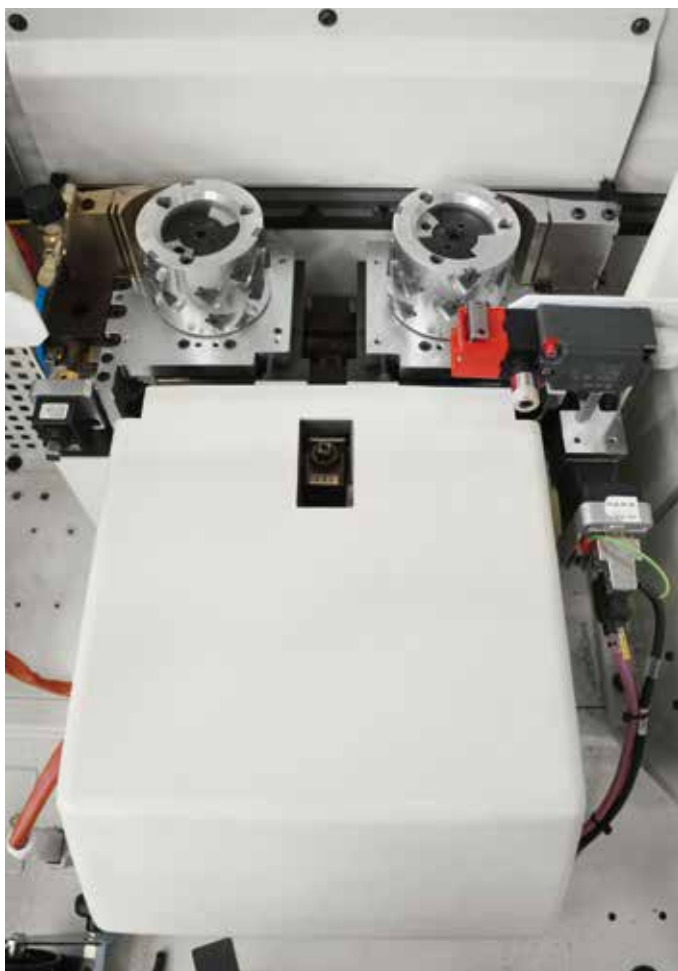

RT-H pre-milling unit.

Ideal for a perfect microfinish of the panel before the edge banding.

- Tool diameter: 100 mm
- Power: up to 4 kW
- Copying/no copying function managed by NC
- Vertical tool position managed by NC



Combi pre-milling unit.

Ideal for bigger removals.

- Tool diameter: 190 mm
- Power: up to 5.5 kW
- Working line adjustable by NC

## MACHINING UNITS FOR THE PANEL SIZING AND SQUARING

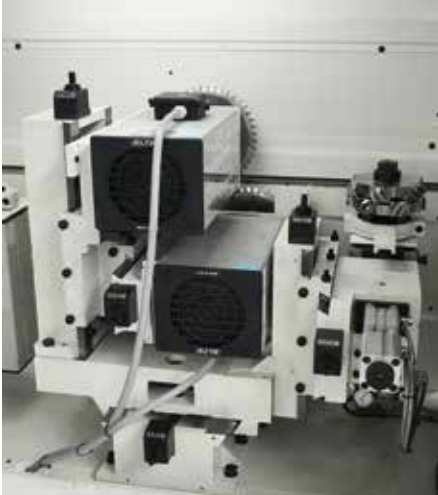

Anti-chipping and double hogging unit.  
Ideal for high levels of chipping.

Tool diameter:

- chipping: 190 mm
- double hogging: 250 mm

Power:

- chipping up to 5.5 kW
- double hogging: up to 11.5 kW

Available also in double hogging  
version only



Hogging + scoring unit.  
Ideal for veneer panels.

Tool diameter:

- scoring: 180 mm
- hogging: 300 mm

Power:

- scoring: up to 5.5 kW
- hogging: up to 11.5 kW

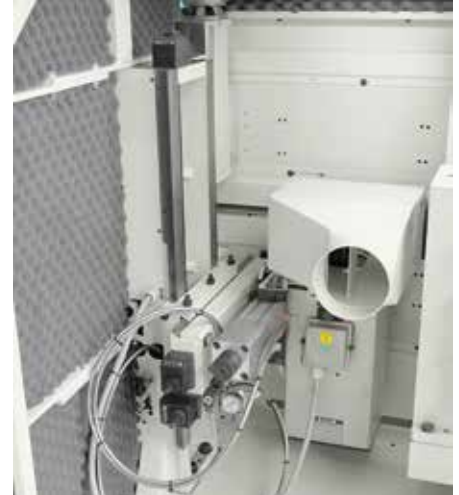

Milling unit.  
Ideal for grooves.

Tool diameter:

- blade: 220 mm
- tools: 125 mm

Power:

- Up to 8.5 kW

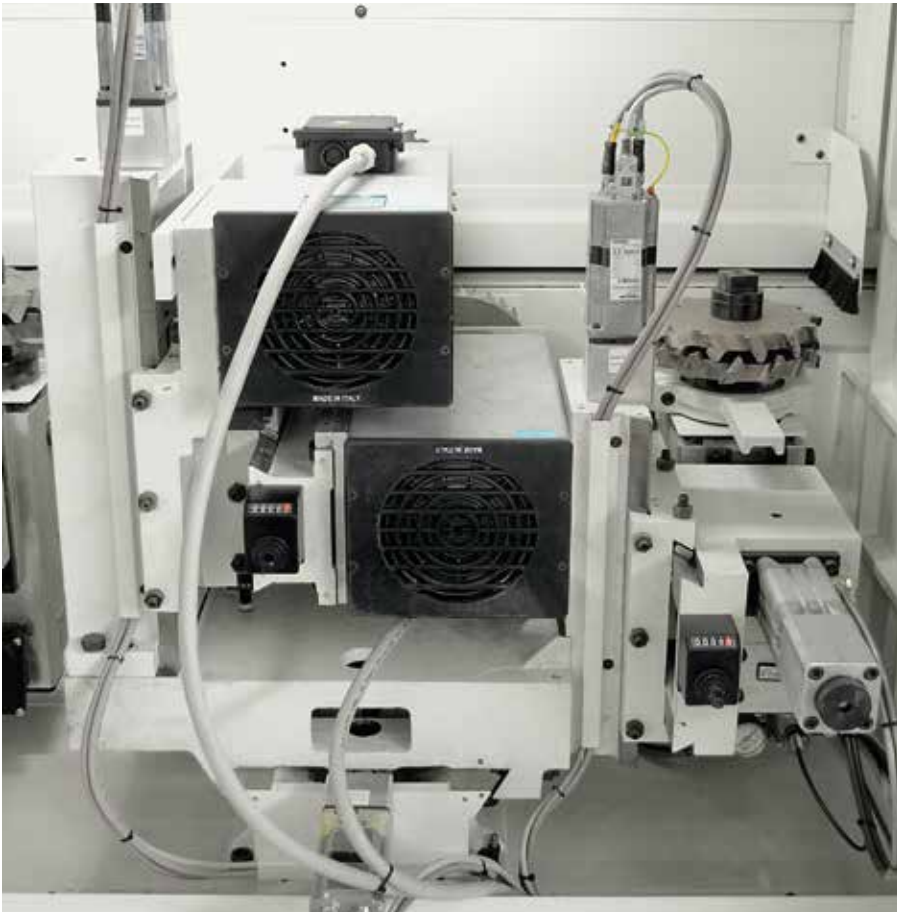

Possibility of:

- NC adjustment in function of the panel thickness
- Working line adjustable by NC



# stefani top

Edge banders – Sizing edge banders

## EDGE APPLICATION

For the production of furniture with high quality edgebanding, an up to task technology of edge application is required. Stefani TOP has a wide and complete range of solutions for the perfect application of the edge, in function of the productivity required, the materials to be applied, and the degree of finishing required.

## GLUING UNITS

For the application of the glue to the panel by means of the glue roller with speed up to 70 m/h.



Possibility of motorized system for edge feeding and cutting, with +/- 2 precision. For cost optimization of waste.



NC dosage of the applied glue quantity depending on glue type or panel. Automatic glue leakage lock when the machine is stopped.

## PREMELTING SYSTEMS

For the melting and continuous feeding of glue



Feeding of glue in granules  
Melt capacity: from 8.5 Kg/h up to 40 Kg/h



Compact premelting device for PU glue in 2 Kg cartridges, integrated in the machine. Melt capacity up to 6 Kg/h. Flexible change between different PU glue color with 2 devices in sequence.



Premelting devices for PU glue in 2 Kg cartridges. Melt capacity up to 16 Kg/h. Possibility of using a SLOTT applicator.

## EDGE MAGAZINES

Device for the automatic and instantaneous changeover of the edge when the roll ends or to change the program.



Versions available: 1 coil, 2 coils, 6 coils, 12 coils, 24 coils.





# stefani top

Edge banders – Sizing edge banders

## ADVANCED TECHNOLOGIES OF THE EDGE APPLICATION

### GLUE LINE OPTIMIZATION

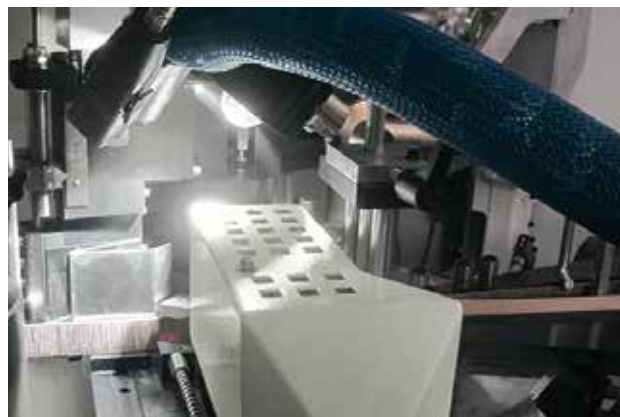

SlimLine  
by 

An incredible glue line with thickness from 0.08 mm can be obtained thanks to the **SlimLine** technology, that allows the glue dosage directly on the edge rather than on the panel. NC management of all process parameters (length, height, thickness of glue line), with the best technical and aesthetic results of the edged panel.

The results of **SlimLine** are certified by 

### ZERO GLUE LINE

Finishing quality and an amazing design can be achieved with the technologies that allow the edging without the use of glue.



AirFusion<sup>+</sup>  
by 

AirFusion<sup>+</sup> allows to make invisible the junction point between edge and panel using the complete range of laser edges or pre-glued edges for application Laser / Hot Air. High-temperature air melts the appropriate layer of adhesive present in the edge, allowing its adhesion to the panel.





# stefani top

Edge banders – Sizing edge banders

WHERE THE QUALITY FURNITURE IS PRODUCED:  
FINISHING UNITS



## END TRIMMING UNIT



Range of horizontal end trimming units for cutting of excess edge after the gluing. They optimize the productivity with speeds up to 30 m/min. Precise and constant cutting thanks to front and side copying devices. Adjustable excess cutting, even by NC.



High productivity end trimming unit sliding by means of linear or power assisted motors to minimize interaction with the panel and guarantee high quality of the edge cutting. Available speed from 35 m/min to 55 m/min

## TRIMMING UNIT



Trimming unit for the removal of the upper and lower excess of the edge.  
Power up to 1.8 Kw  
Standard double vertical position for the rough trimming/finishing of the edge

## FINE TRIMMING UNIT



Fine trimming unit for edge finishing with chamfer / radius. Power up to 1.8 kW.  
Up to 3 radii + 1 chamfer automatically with different equipments.  
TwinFeeler for a precise copying even at high speed  
ZeroLock for precise and quick tool connection



# stefani top

Edge banders – Sizing edge banders

## CORNER ROUNDING UNITS

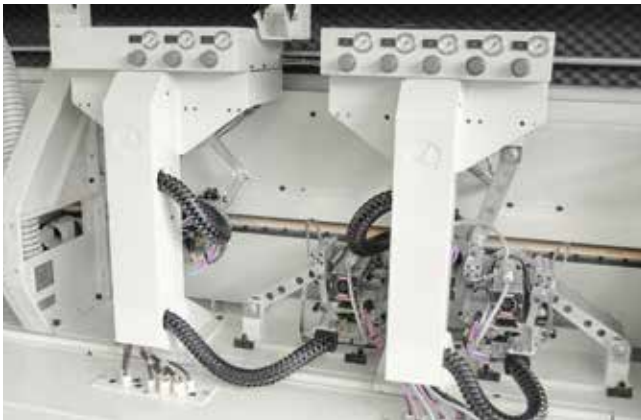

### CORNER ROUNDING UNIT WITH 4 MOTORS

For the complete processing of the straight/shaped panel with the rounding of the corners and the fine trimming of the sides also with wooden/veneer edge.

Speed up to 25 m / min. Speed up to 35 m / min with power assisted movement of motors for an extra finishing quality. 8 mm minimum panel thickness. Equipments for NC automatic processing up to 3 radii + infinite thin edges.



### CORNER ROUNDING UNIT WITH 2 POWER ASSISTED MOTORS

For the complete processing of the straight / shaped panel. Rounding of the corners and fine trimming of sides with power assisted movements that maximize the performance of automatic machining.

Speed up to 35 m/min. Equipments for NC automatic processing up to 3 radii + infinite thin edges or changeover up to 8 single-process tools by NC.



### CORNER ROUNDING UNIT WITH 2 MOTORS

For the complete processing of the straight/shaped panel with the rounding of the corners and the fine trimming of the sides also with wooden/veneer edge. Speed up to 25 m/min for rounding and 30 m/min for longitudinal fine trimming.

2 power assisted motors, from 12000 to 18000 rpm for an extra quality finishing. 8 mm minimum panel thickness, 80 mm maximum thickness on request. Equipments for automatic processing thanks to MULTIEDGE 3P tool holder and NC feeler positioning.



### AN EVOLVED PROCESS, STARTING FROM DETAILS

Processing up to 3 radii + infinite thin edges with NC instant exchange with compact and lightweight MULTIEDGE device. Monoblock tools with 4 cutters, rotation speed up to 18000 rpm.



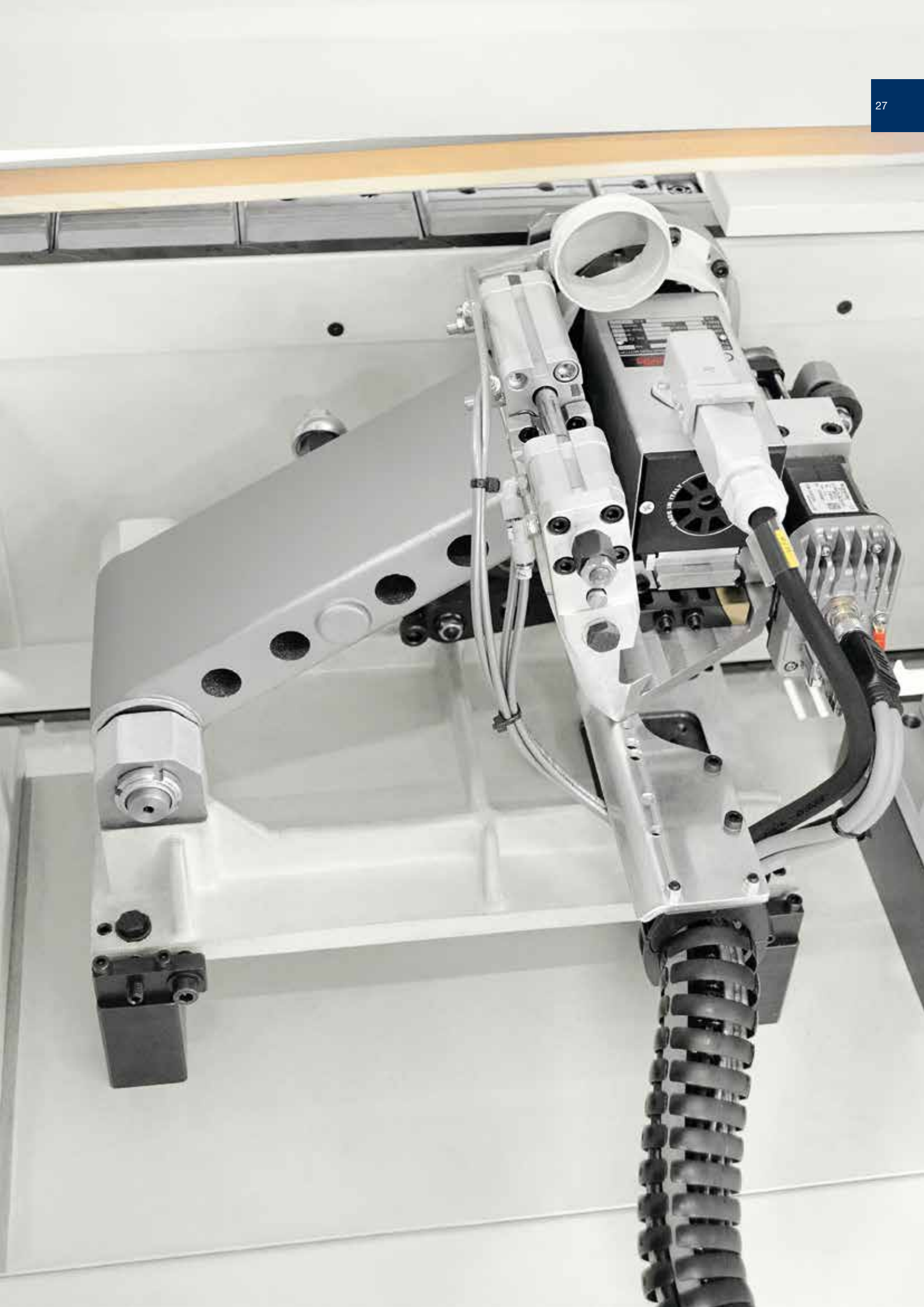

# stefani top

Edge banders – Sizing edge banders



A PANEL PERFECT IN EVERY DETAIL

## GROOVING UNITS

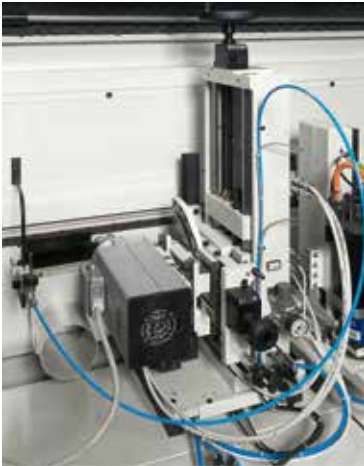

Grooving unit for slots/grooves  
Power up to 5,5 kW  
Possibility of NC horizontal and vertical axes  
Tool: 125 mm diameter x 70 mm



Possibility of motors with HSK release and more tools  
Installed on the shaft.



Flexible grooving unit for slots/grooves with NC flexible exchange up to 8 tools.  
Power up to 8,5 kW  
Possibility of horizontal and vertical NC axes and rotation.  
Tool: 125 mm diameter x 70 mm.

## EDGE SCRAPING UNIT



Versions up to 4 profiles with an NC-exchange.



TwinFeeler for a perfect copying even at high speed.

Unit for the final smoothing of the edges previously machined with tool.

### GLUE SCRAPING UNIT



For the removal of any residual glue from the surface of the panel.



Spray device for the lubrication of the blades and for the brightening of ABS edges.

### BRUSHING UNIT



Rotating brush device for the brightening and the final cleaning of the applied edge.

### INK-JET UNIT



Inkjet printer for the marking of the panel in the upper or lateral surface.

### SANDING UNITS

For the surface finishing of veneer / wooden edges



Sanding unit for chamfers/radii.



Sanding unit for profiled panels.





# M Maestro Digital Systems

SMART SOFTWARE AND DIGITAL SERVICES TO ENHANCE PRODUCTIVITY OF WOODWORKING AND FURNITURE INDUSTRIES.

> programming and data generation

Maestro office

Office

Factory

Maestro active

> edge banding

## SOFTWARE

### Simple, smart and open.

Maestro software are tailored on the machine technology as well as on the entire process. All Maestro software share a common mission:

**easy to use**, so that any operator can easily and confidently learn and use the software

**smart**, with algorithms and computing modules aiming at the best possible result

**open** in order to integrate existing software, and provide customer the coverage of all his process.



SCM accompanies woodworking companies throughout their whole process combining machines with matching software solutions and digital services, with a constant strive to enhance company productivity.

The software solutions powered by SCM are developed to optimize machine usage as well as the entire process, providing integration with the different software existing in the company.

## DIGITAL SERVICES

Transforming the way it delivers services to its customers through digital technologies and particularly, the IoT platform that collects and analyses data coming from the machine, **SCM created a world of services enabled by Maestro connect.**

Meaning that connecting an SCM machine through Maestro connect will let customer subscribe a program of fast-evolving services and access a wide range of benefits that even go beyond the machine experience and will support and assist you through the whole life-cycle of your machine.

### Maestro connect IoT Platform

1  
Machine monitoring,  
KPIs, early warning

2  
Maintenance  
equipment

3  
Predictive  
maintenance

4  
Report and historical  
data export to MES

5  
Warranty  
extension

6  
Augmented  
remote support

7  
Smart learning,  
SELF-HEALING,  
video tutorials

8  
Asset management  
with e-shop SCM  
Spare Parts





# Maestro edge

Before the production, it is possible to program and generate edge banding programs directly from the office.



## SOFTWARE

Office

## Maestro edge

# PROGRAMMING THE EDGE BANDER DIRECTLY FROM THE OFFICE

## FUNCTIONS

- Display of all the information present in Maestro active edge
- Receipt of machine production reports generated by the Maestro active edge
- Remote programming with creation of new edges and tools

With the same interface of Maestro active edge, the office software Maestro edge allows you:

- edit machine programs directly from the office
- recall, view and modify existing programs in the machine



## Maestro active edge

Maestro active is the new operator interface software which has been unified across all SCM technologies. A single operator can easily and confidently run multiple machines due to controller and interface consistency: regardless the machine, Maestro active maintains the same look&feel, with many identical icons and navigation buttons, thus ensuring the same approach to interaction.

### EASE OF USE

The new interface has been specifically designed and optimized for immediate use via touch screen. Graphics have been redesigned for simple and comfortable navigation, with tablet-like icons on touch screen controller.

### “ZERO” ERRORS

Improved productivity thanks to integrated help and recovery procedures that reduce the possibility of error from the operator's side.

## SOFTWARE

## Factory

## Maestro active edge

# A REVOLUTIONARY APPROACH TO INTERACT WITH YOUR SCM MACHINE

### FULL CONTROL OF PRODUCTION PERFORMANCES

The creation of customizable reports by operator, shift, program, forecast period (and much more) allows to monitor, optimize and improve the production performance.

### FULL MACHINE AWARENESS AND KNOWLEDGE MANAGEMENT SYSTEM

Maestro active allows to record the times related to setup, maintenance, training and other events, tracing all the activities in a database. The operator's know-how is also stored and made available to other people inside the organization thanks to the possibility to comment and document all production events or notifications.

### ORGANIZE YOUR PRODUCTION

Maestro active allows to create different users with different roles and authorizations (e.g.: operator, maintainer, administrator, ...). Any user can only execute the functions whose permissions have been assigned to him. It is also possible to define the work shifts on the machine and then detect activities, productivity and events that occurred in each shift.

# A WORLD OF SERVICES FOR GREATER EFFICIENCY

## Maestro connect

### CONNECT YOUR MACHINE AND GAIN ACCESS TO A WORLD OF SERVICES

Connecting your machine through IoT technology, Maestro Connect will let you subscribe a program of fast-evolving services. You will access a wide range of benefits that even go beyond the machine experience and will support and assist you through the whole life-cycle of your machine.

### FASTER SERVICE INTERVENTION AND PROBLEM RESOLUTION

Maestro Connect provides real time data and Health Records of the Machine also to SCM Service drastically reducing its troubleshooting time.

### WORKING ALWAYS IN PERFECT CONDITIONS

Maestro Connect can provide a full kit of sophisticated sensor devices to detect and warn the operator in case of alarming conditions of the machine.

## DIGITAL SERVICES

### SMART MAINTENANCE: DOWN TIME REDUCTION

Maestro Connect reduces maintenance downtime thanks to:

- Automatic maintenance notifications and scheduling, to prevent failures and work in the best conditions of use
- Direct connection to SCM Service thanks to an automatic ticket opening function

### SMART MACHINE: ANYTIME, ANYWHERE AWARENESS

Connecting your SCM machine also means having your machine always at hand.

Immediate instant notifications in case of alarms or downtimes allow customers to immediately take an action thus optimizing his productivity.

### SMART MANAGEMENT: PRODUCTION PERFORMANCE OPTIMIZATION

Reports and KPIs allow further analysis thus increasing Customer Knowledge about his performance and results.

### SMART PARTS: FAST PARTS REPLENISHMENT

MRepairs are scheduled proactively since the system provides Spare Parts suggestions and a direct Integration with Smart Parts e-shop.

### SMART LEARNING: EXECUTE WORK AND RECEIVE PROBLEM SOLVING SUPPORT

Maestro connect provides an intuitive Problem Solving Management System to help the operator to self solve any issue..

### SMARTECH: FASTER AUGMENTED SUPPORT

Maestro connect allows augmented reality support by means of Smartech: the head-wearable computers with wireless connectivity that will bring the interaction between customer and SCM service to a higher level.

### SMART WARRANTY: YOUR MACHINE ALWAYS IN PERFECT CONDITIONS

Together with scheduled maintenance contracts, you can take care of your asset by doubling the warranty from 1 year to 2 years\* for complete peace of mind!

\* Please read the complete contract to understand terms and conditions.





# stefani top

Edge banders – Sizing edge banders

## LAYOUT

### STEFANI ONE - TWO

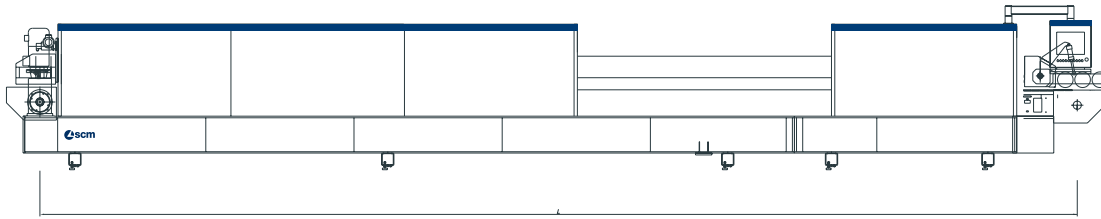

### STEFANI SSB - SB

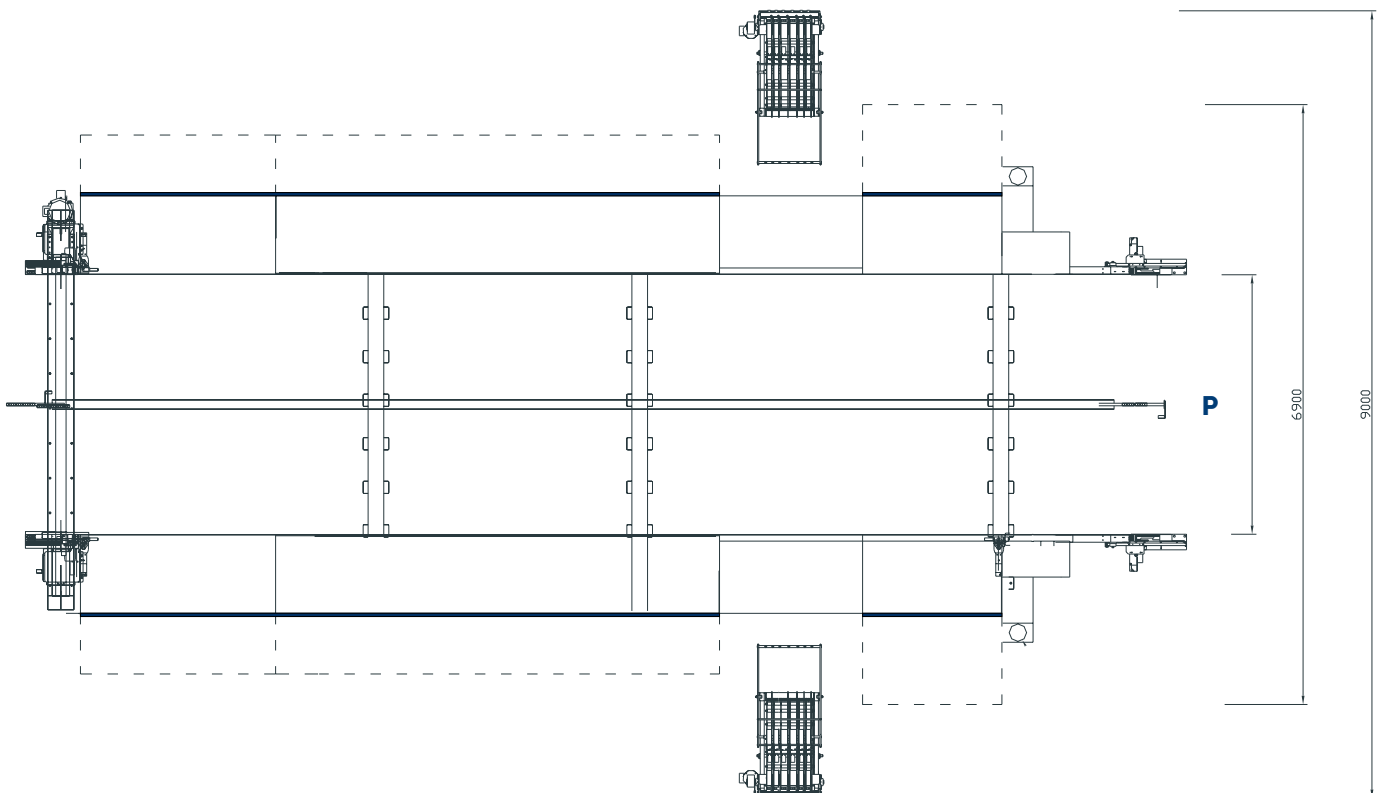
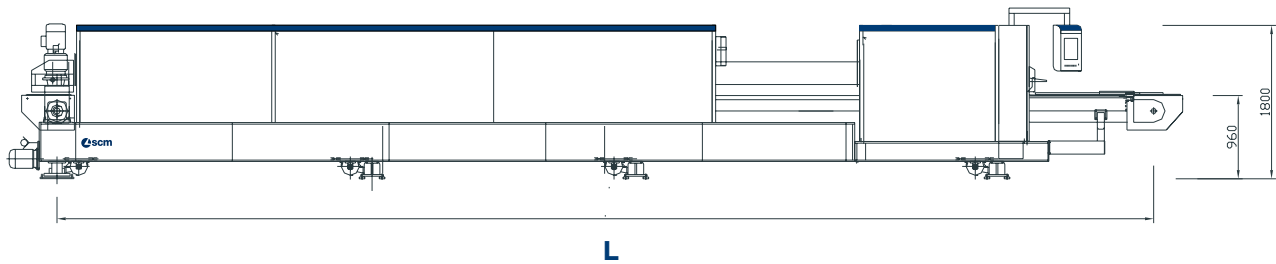

# TECHNICAL DATA

## STEFANI ONE - TWO

	Speed	Interaxis max. L	Panel width (min/max) P	Panel thickness (min/max)	Working line (min/max)
stefani one	40 m/min	15.300 mm	90 mm (min)	8/80 mm	35/90 mm
stefani two	40 m/min	15.300 mm	225/3.700 mm	8/80 mm	35/90 mm

## STEFANI SSB - SB

	Speed	Max opening speed of beams	Interaxis max. L	Panel width (min/max) P	Dog distance	Automatic height of dogs	Panel thickness (min/max)	Working line (min/max)
stefani sb one	40 m/min		15.300 mm	90 mm (min)			8 / 80 mm	35/90 mm
stefani ssb	40 m/min	10 m/min	12.600 mm	225/3.700 mm	900 mm (opt 500 - 400 mm)	12/18/25	8 / 80 mm	35/90 mm
stefani sb	40 m/min (opt 70 m/min)	10 m/min	18.200 mm	225/3.700 mm	500 mm (opt 300 - 400 mm)	12/18/25	8 / 80 mm	35/90 mm
stefani 60	40 m/min (opt 70 m/min)	10 m/min	18.200 mm	60/1600			8 / 80 mm	35/90 mm

## PROCESSABLE MATERIALS

### EDGES

TYPE OF EDGE	EXAMPLE OF APPLICATION	MAX THICKNESS
Paper	Raw / prepainted	0,6 mm
Plastic in coil	ABS, PVC, PP (with/without film) PMMA (polished or rough to polish / smooth)	3 mm
Aluminum	Shine/ Satin	3 mm
Precut strips	Veneer, PC, Unicolor	1 mm
Solid wood	Raw / polished / drawn	25 mm

### PANELS

TYPE OF PANELS	EXAMPLE OF APPLICATION
Chipboard	
MDF	Only profiled/edged
Light panels	With frame/without frame
Solid wood	Profiled/smooth
Other materials	Aluminium/Cardboard PC/Tri Wall Polycarbonate Sheet/plasterboard

### ZERO JOINT

PRE-GLUED EDGES		COEXTRUED EDGES	
AirFusion* Application	Yes	AirFusion* Application	Yes
LaserLine Application	Yes	LaserLine Application	Yes

### GLUES

HOT-MELT GLUE	
EVA glue	Yes
PU glue	Yes
SLIM LINE	Yes

**COMPANY WITH  
QUALITY SYSTEM  
CERTIFIED BY DNV GL  
= ISO 9001 =**

## CONSUMPTION/POWER

Supply voltage: **400 V/50 Hz EU** (customizable depending on the country)  
 Installed power (kW): depending on the machine equipment  
 Compressed air pressure for connection: **6 Bar**  
 Compressed air consumption (NL / min): depending on the machine equipment  
 Suction: air speed **30 m/sec**  
 Suction: air consumption (m<sup>3</sup>/sec): depending on the machine equipment  
 Suction: exhaust outlet diameter from **80 mm to 140 mm**

## CONNECTIVITY

ETHERNET (std)  
 USB (std)  
 WI-FI (opt.)

# PROMPT AND EXPERT TECHNICAL SUPPORT THROUGH A NETWORK OF 1000 TECHNICIANS AND AN INVENTORY OF 36,000 SPARE PARTS.

HIGHLY SPECIALISED TECHNICIANS, EFFICIENT MANAGEMENT AND 6 SPARE PARTS BRANCHES AROUND THE WORLD GUARANTEE A CLOSE, SAFE AND EFFECTIVE TECHNICAL SUPPORT.

## SERVICE

SCM provides a service that goes beyond the purchase, to guarantee the long term performance of your technological production system and peace of mind for your business.

### A COMPLETE RANGE OF AFTER-SALES SERVICES

- installation and start-up of machines, cells, lines and systems
- tailored training programs
- telephone support to reduce times and costs when machines are not working
- preventive maintenance programs to guarantee long term performance
- complete renovation of machines and plants to renew the added value of the investments
- custom upgrading to update machines and plants and meet new production requirements

## SPARE PARTS

SCM Group can count on 140 spare parts professionals worldwide to meet any request with real time shipments.



### 36,000 SPARE PARTS

Our spare parts inventory, with a value of 12 million euros, covers every single machine



### SPARE PARTS GUARANTEED

We guarantee also hard to find parts, with 3,5 million euros invested in "critical" spare parts.



### IMMEDIATE AVAILABILITY

Over 90% of orders received are carried out the same day thanks to the huge inventory available.



### 6 BRANCHES AROUND THE WORLD

The spare parts service can count on worldwide support (Rimini, Singapore, Shenzhen, Moscow, Atlanta, São Bento do Sul)



### 500 SHIPMENTS A DAY





# THE STRONGEST WOOD TECHNOLOGIES ARE IN OUR DNA

## SCM. A HERITAGE OF SKILLS IN A UNIQUE BRAND

Over 65 years of success gives SCM the centre stage in woodworking technology. This heritage results from bringing together the best know-how in machining and systems for wood-based manufacturing. SCM is present all over the world, brought to you by the widest distribution network in the industry.

**65** years history

**3** main production sites in Italy

**300.000** square metres of production space

**20.000** machines manufactured per year

**90%** export

**20** foreign branches

**400** agents and dealers

**500** support technicians

**500** registered patents

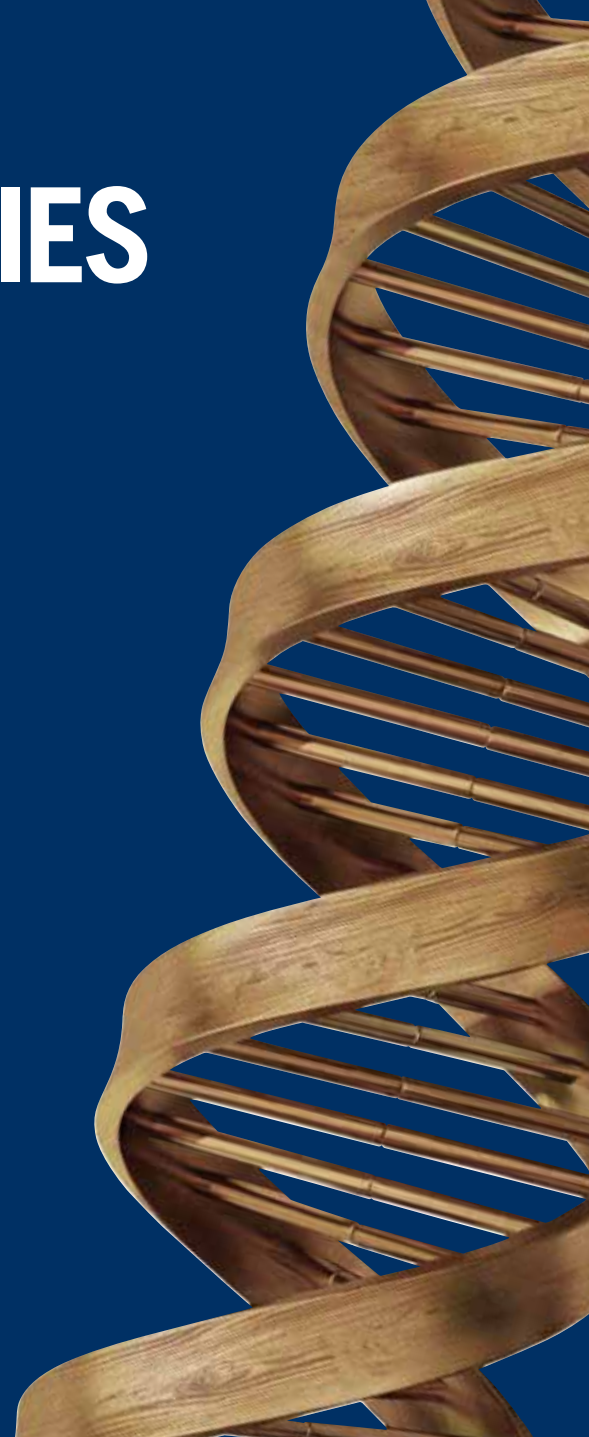

In SCM's DNA also strength and solidity of a great Group. The SCM Group is a world leader, manufacturing industrial equipment and components for machining the widest range of materials.

## SCM GROUP, A HIGHLY SKILLED TEAM EXPERT IN INDUSTRIAL MACHINES AND COMPONENTS

### INDUSTRIAL MACHINERY

Stand-alone machines, integrated systems and services dedicated to processing a wide range of materials.



WOODWORKING TECHNOLOGIES



TECHNOLOGIES FOR PROCESSING  
COMPOSITE MATERIALS, ALUMINIUM,  
PLASTIC, GLASS, STONE, METAL

### INDUSTRIAL COMPONENTS

Technological components for the Group's machines and systems, for those of third-parties and the machinery industry.



SPINDLES AND  
TECHNOLOGICAL  
COMPONENTS



ELECTRIC PANELS



METALWORK



CAST IRON



*is more*



**SCM GROUP SPA**

Via del Lavoro, 1/3 - 36016 Thiene (VI) - Italy  
tel. +39 0445 359511 - fax +39 0445 359599  
stefani@scmgroup.com  
www.scmwood.com



00L0366212C