

Conveyor Technology

Venjakob

-Quality. For your success!

Conveyor Technology

Venjakob. A renowned worldwide producer of spray equipment and conveyor technology, recognised for high quality and innovative designs.

The name is synonymous with close collaboration with the customer to produce a design which is economical and suitable for the environment.

Contents

Contents	1
Conveyor technology	2
Linear transports	3-4
Transport on curves	5-6
Transfers	7
Angle transfer	7
Collection/Separation	8
Rotation/Turning	9
Stacking	10
Installations	11-13
Installations	11-12
Special installations	13
Control	13
Service	14
Service	14
How to get there	14

Conveyor technology

Conveyor technology serves as a connecting link and transport element between existing and newly installed machines.

In addition to the products described here, we endeavour to fulfill our customer's special requests, whenever possible.

Our product programme includes every kind of transport element, such as:

- belt conveyors
- roller conveyors
- cross bar conveyors
- pile and disc conveyors
- curve installations 90° and 180° in form of belt, roller, cross bar curves
- angle transfers 90° and 180°
- rotating and turning devices
- floor conveyors as drag chains and push rod conveyors
- feeding and stacking devices

The following are included amongst our partners:

- automotive
- wood
- furniture
- audio
- plastic
- glass
- buildings
- leather
- moulding
- rubber
- metal

They place special demands on conveyor technology. Accordingly, it is common that standard elements can be used for more purposes than is, in general, expected.

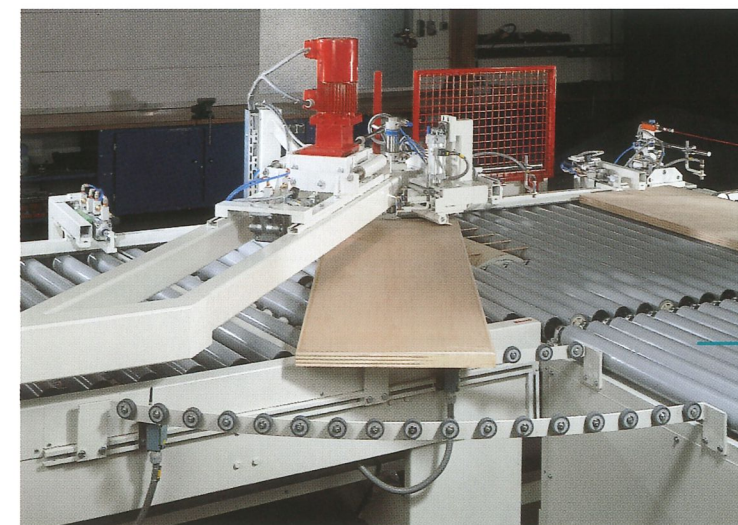

Rotary device combined with cam rocker arm and tapered cone

Linear transports

The following are available as linear conveyor systems, in diverse and well-proven designs:

- belt conveyors
- roller conveyors
- cross bar conveyors
- pile and disc conveyors

Special designs are also available!

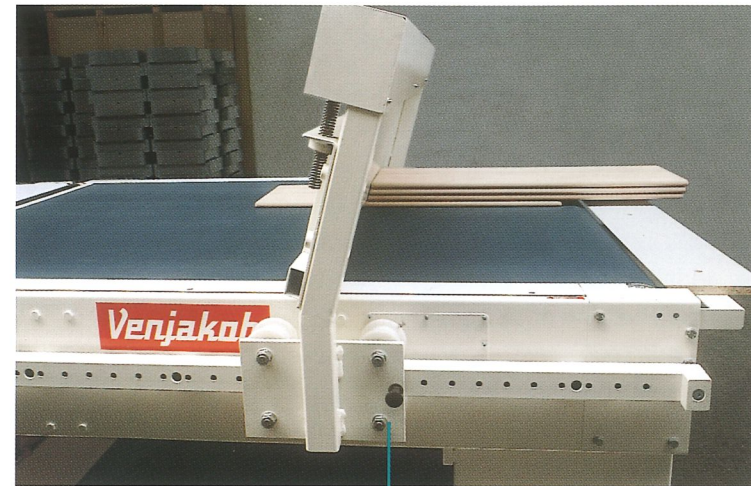

Stack stop on a conveyor belt

Turning station with infeed roller conveyor

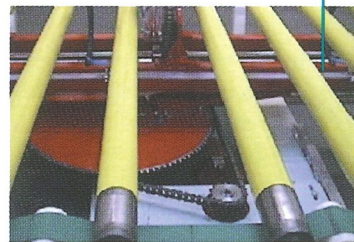

Grid conveyor belt



Roller conveyor with workpiece transfer station, from single to double track

Belt conveyor linked into a finishing line

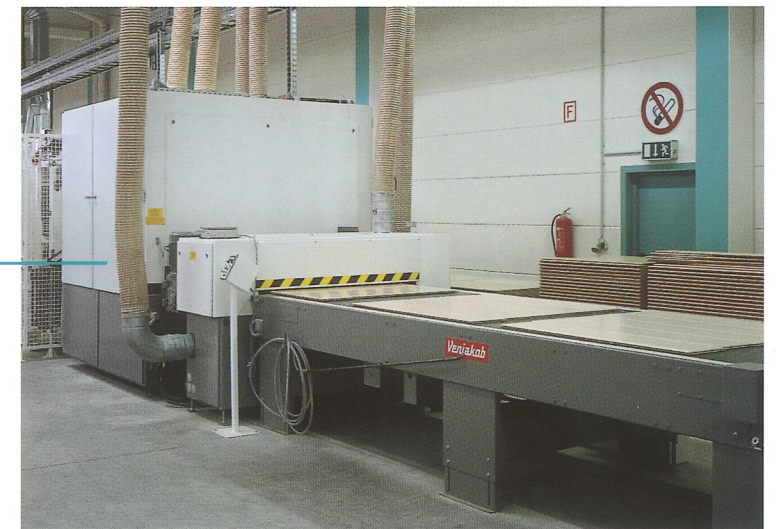

Transport on curves

Conveyor belt curve

The **patented**, Venjakob module conveyor belt curve conveys small parts, as well as large workpieces, without problem, carefully and quietly.

In addition, trapezoid sheet metal roller curves, cross bar and belt curves in 90° and 180° designs are available.



Partial view: workpieces can project in the inner radius



Partial view: workpieces can project over the outer radius



Returning parts by means of a 180° conveyor belt curve

The construction allows workpieces to project beyond the curve dimensions. They convey small parts and large workpieces without problems, carefully and quietly.

Transfers

Angle transfer

Different to curve conveyors, the angle conveyors operate in cycles.

Depending on requirements, they can be used as collecting or separating devices.

Designs with 90° or 180° are possible as **belt, chain or transverse grid conveyors**. Workpiece transfer from lengthwise to crosswise, or from crosswise to lengthwise, can be implemented by grid, cam or electro-pneumatic devices.



Grid-angle transfer 180°, used as a workpiece return device



Belt angle transfer 90°, from lengthwise to crosswise conveyance

Collection/Separation

Production processes may require the collection, separation or bringing together of workpieces.

These components are designed specifically for the task required.



Workpiece separation by means of eccentric-operated cams, from crosswise transportation to lengthwise

Transfers

Rotation/Turning

The processing of workpieces frequently requires a rotation from lengthwise to crosswise or from crosswise to lengthwise.

A simple and safe solution is **rotation**, making use of a tapered roller or cam-operated rocker.

Turning is used when processing the surface of workpieces on both sides is required. Depending on the production requirements, there are a number of solutions which our company has developed.



Turning station for processing the surface of workpieces on both sides

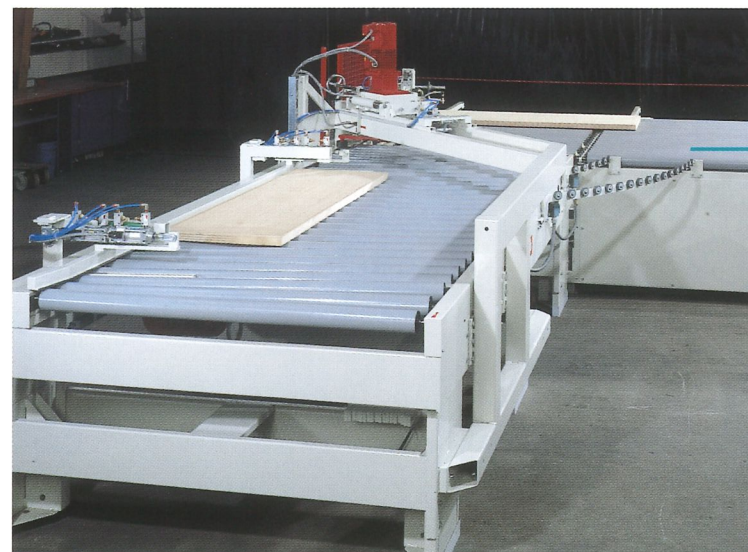

Rotary station for processing of edges on all sides (e.g. with DET)

Stacking

Stacking equipment frequently forms the beginning or the end of a production line. Feeding or removal of parts takes place precisely and automatically.

Our feeding and stacking devices are equipped with transverse vacuum suction in pit or pitless designs, with different performance levels.

Double-sided, high-performance automatic stacking machine with workpiece alignment



Installations

As a supplier of complete systems, we incorporate standard or special components in planning the equipment and apply these individually according to the project criteria.

We employ the most modern control technology programmes and switch cabinets, which have been developed and produced at our company.

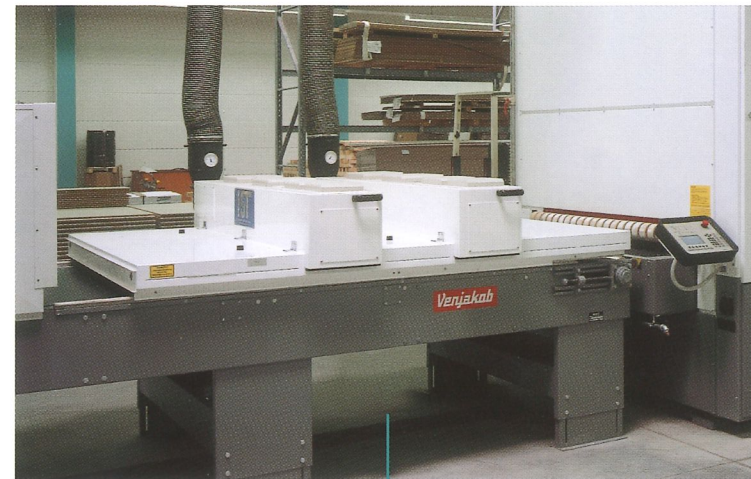

Curing after a spraying process, with following direct sanding operation



View of the complete finishing plant with grid transfer

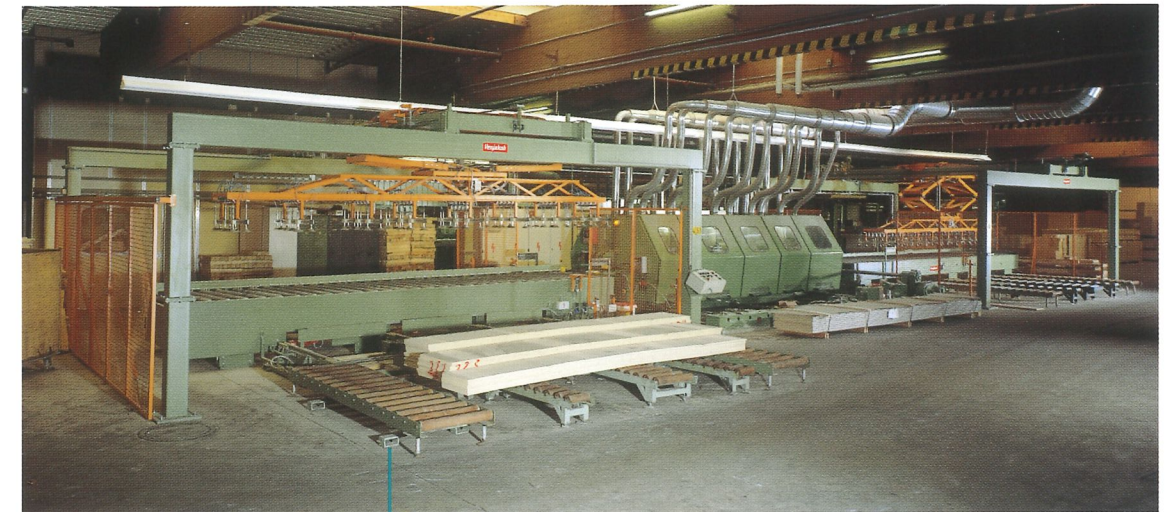

Loading and off loading by stacking device for large workpieces, before and after edge treatment

Partial view of conveyor equipment with stacking device, transfer station and finishing section

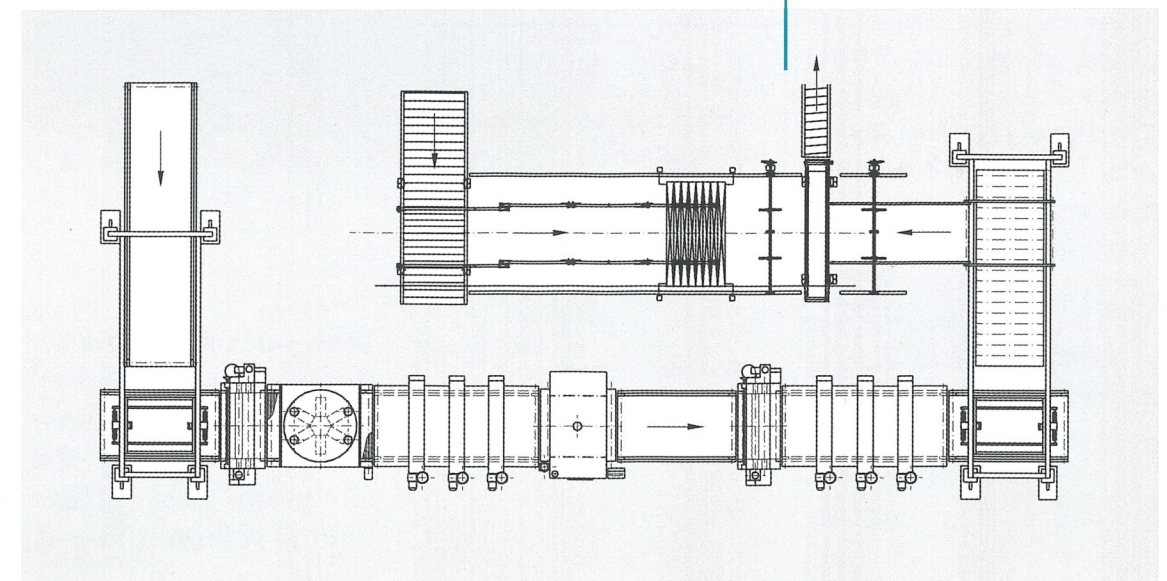

Installations

Special installations

Exceptional customer requirements have always given the impetus for the production of special machines and equipment. They have never been produced before in this form.

The solutions for these problems are individually developed. This is a culmination of our knowledge of equipment, ideas, inventiveness and creativity, as well as close collaboration on the basis of a partnership with our customers. Together, we have already solved many difficult tasks.

Control

As a supplier of installations, we use the most modern electronic, control and drive elements available on the market.

We prepare the programmes ourselves and test them before delivery to customers.



The result of a cooperation partnership between manufacturer and the customer

Part of the feed equipment with automatic, double-sided stacking machine, as well as a workpiece turning section

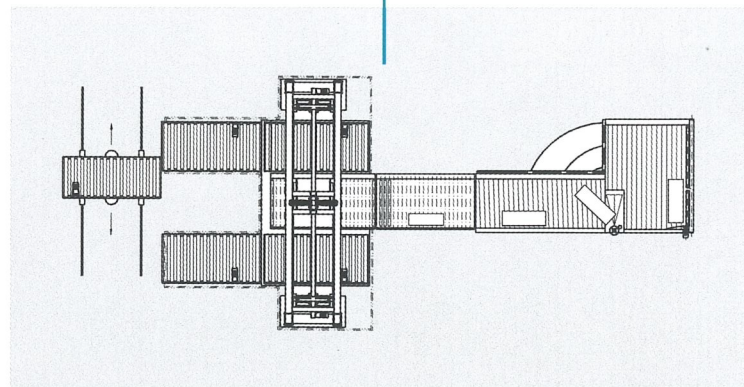

With all Venjakob products, the individual wishes of the customer represents for us the challenge to create unique solutions to problems.

Service

Service

All products conform to internationally valid technical standards.

We enclose comprehensive documentation with our equipment which, in conjunction with other items enables a rapid diagnosis in the event of a fault arising.

Long-distance maintenance by modem is also an option.

Our extensive store of replacement parts guarantees a fast spare part service. This is supported by our customer service and installation department, with specialists in mechanics and electronics.



How to get there

You leave the **A 2** at exit **Nr. 23** Rheda-Wiedenbrück. Follow the **B 64** for 4 km in the direction of Münster, as far as the exit Harsewinkel/**Industriegebiet Pixeler Strasse** and then here you turn right. At the stop sign, turn right again and after 2 km you arrive at the entry to the town of **Rheda**. The second street on the right (Augsburger Strasse) will lead you directly to us.

Conveyor technology

Linear conveyors
Conveyor curves
Transfers
Complete installations

Spraying equipment for surfaces and moulded parts

Spraying machines
Air technology, dryers
Complete installations
Special machines

Spraying equipment for mouldings and profiles

Spraying machines
Air technology, dryers
Complete installations
Special machines

Company profile

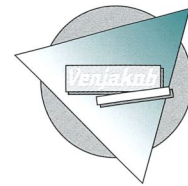
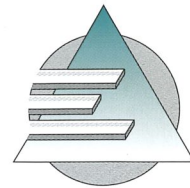
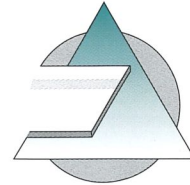

Venjakob Maschinenbau GmbH & Co. KG

Augsburger Strasse 4-6 · 33378 Rheda-Wiedenbrück
P.O. Box 2509 · D-33353 Rheda-Wiedenbrück
Telephone (+49) 5242/9603-0 · Fax (+49) 5242/960340
E-Mail info@venjakob.de
Internet www.venjakob.de · www.venjakob.com

Venjakob

-Quality. For your success!

Version dated May 1999.

We reserve the right to make changes in construction.
We accept no liability for mistakes and errors in printing.