

B'AUERLE

***Querprofil-Fräasersätze
für***

B'AUERLE

***Profilfräsmaschinen
PM 200, PM 250, PM 510***

Profil Nr. 1

W1/W2 = 1. bzw. 2. Werkzeugaufspannung

HSS-bestückt

Z = 3

mech. Vorschub

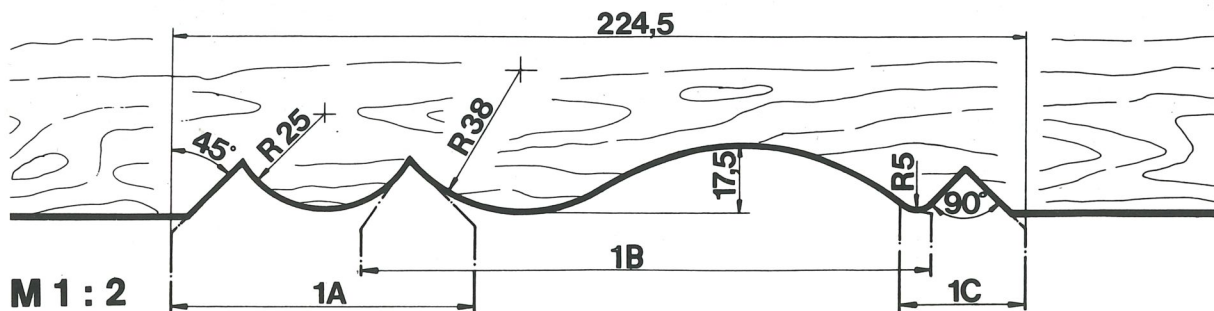
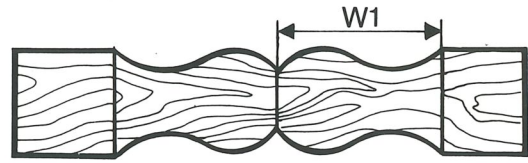
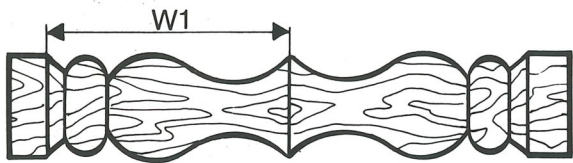
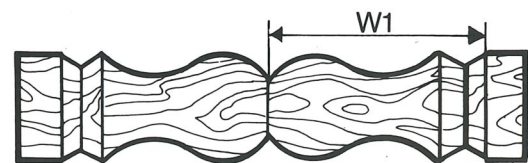
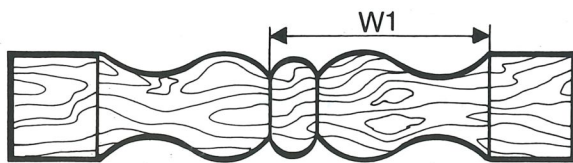
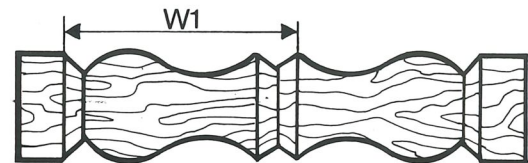
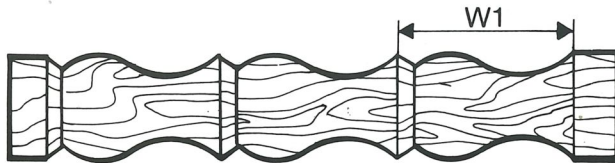
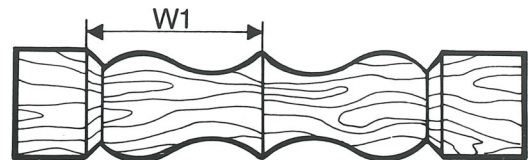
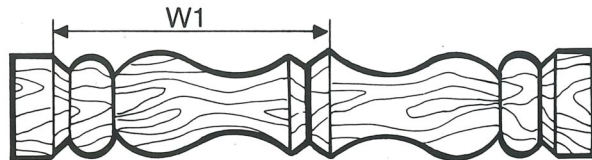
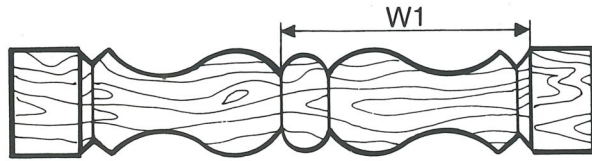
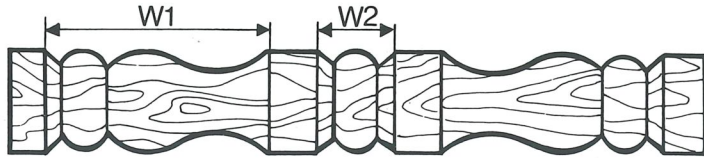

DM 2725,-

Profil Nr. 2

W1=1 Werkzeugaufspannung

HSS-bestückt

Z = 3

mech. Vorschub

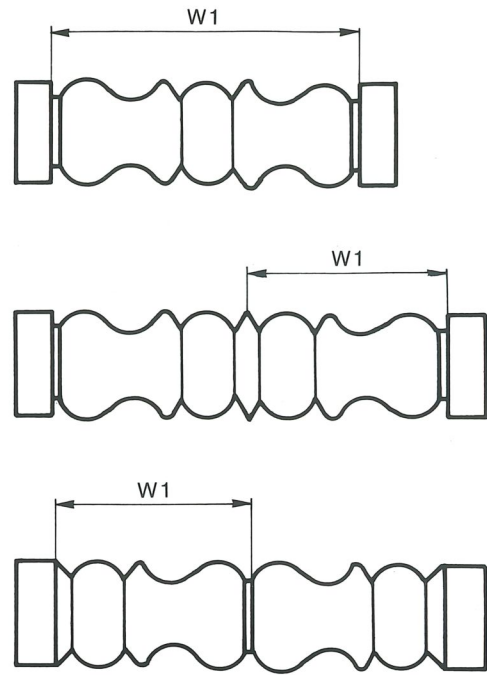
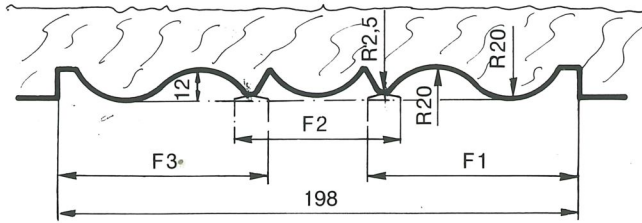

DM 2 480,-

Profil Nr. 3

W1/W2=1. bzw. 2. Werkzeugaufspannung

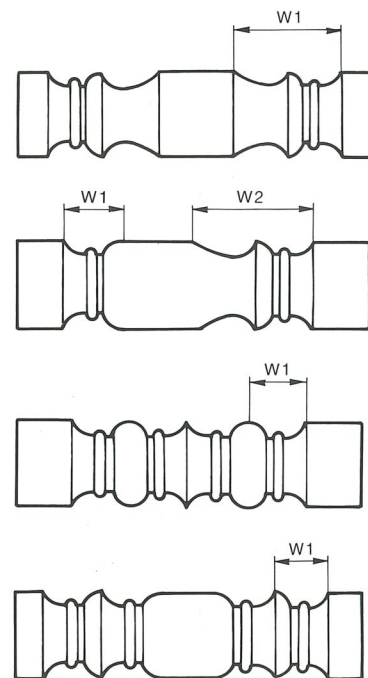
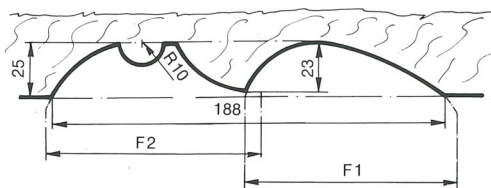

DM 2 140,-

Profil Nr. 4

W1=1 Werkzeugaufspannung

HSS-bestückt

Z = 3

mech. Vorschub

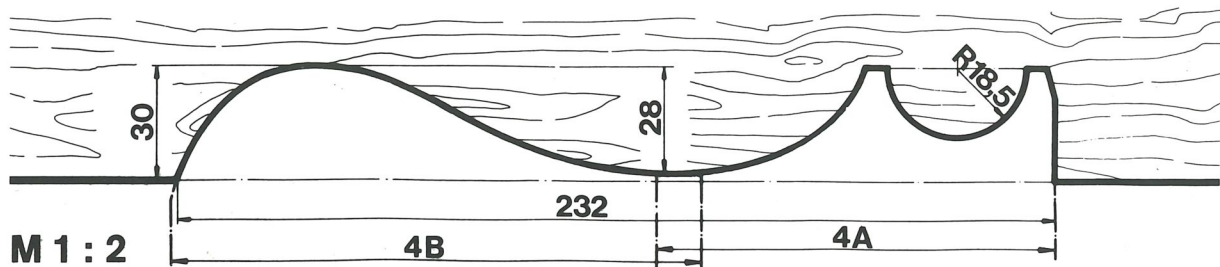
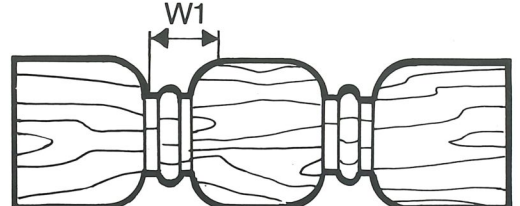
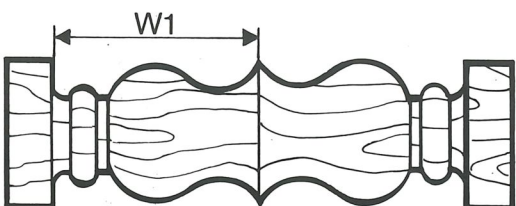
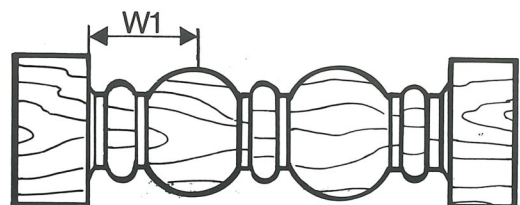
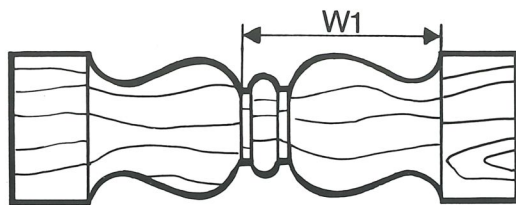

DM 2 690,-

Profil Nr. 5

HSS-bestückt

Z = 3

mech. Vorschub

W1/W2 = 1. bzw. 2. Werkzeugaufspannung

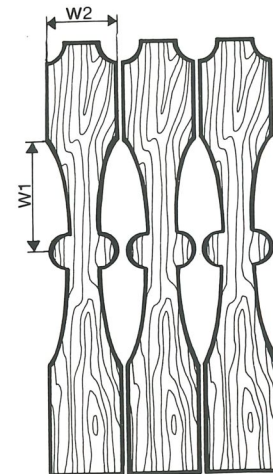
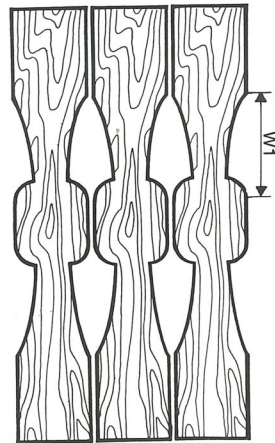
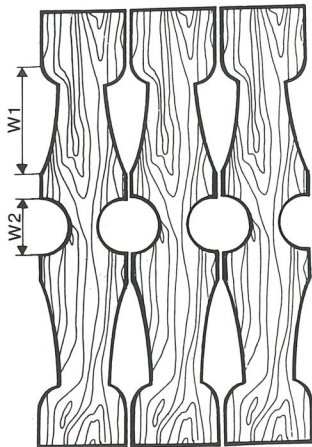
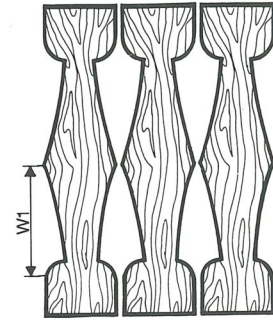
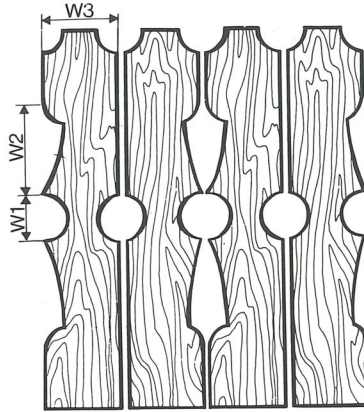
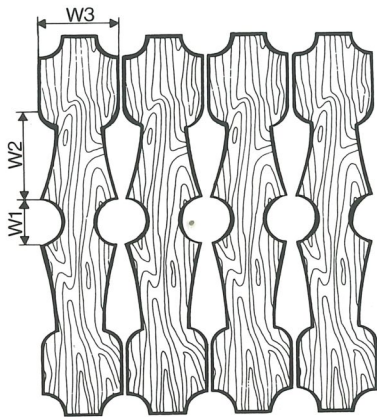

M 1:2

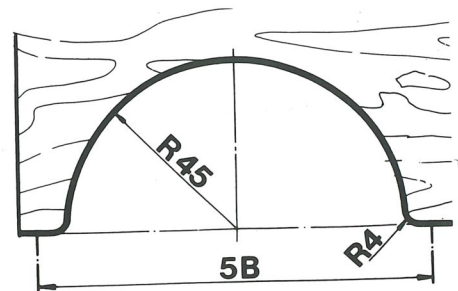
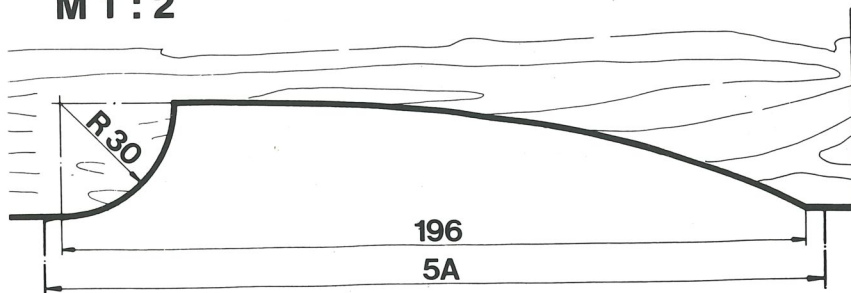

DM 3210,-

Profil Nr. 6

W1/W2=1. bzw. 2. Werkzeugaufspannung

HSS-bestückt

Z = 3

mech. Vorschub

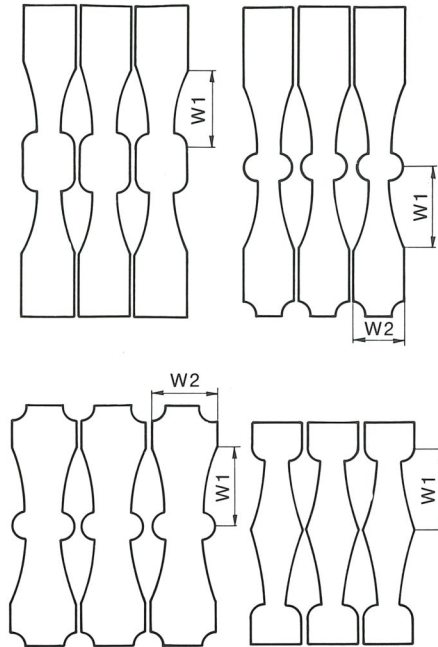
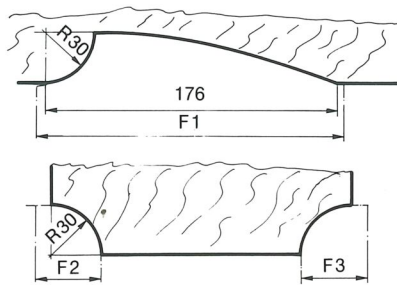

DM 3060,-

Profil Nr. 7

W1/W2/W3=1., 2. bzw. 3. Werkzeugaufspannung

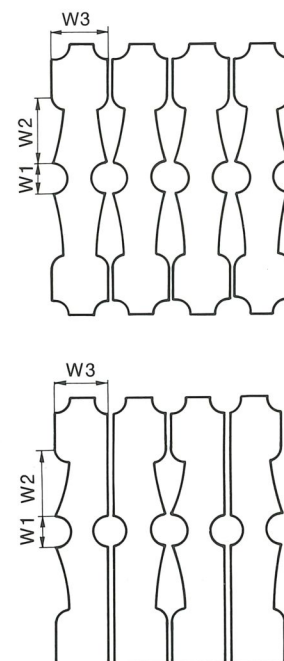
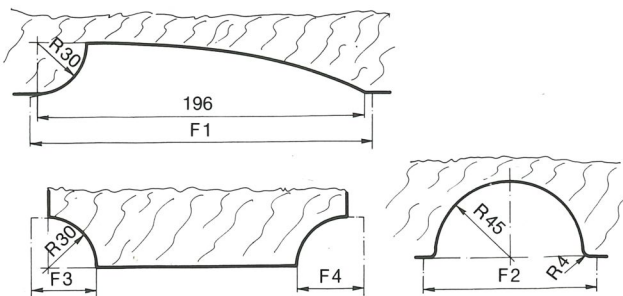

DM 4440,-

Profil Nr. 8

W1/W2/W3=1., 2. bzw. 3. Werkzeugaufspannung

HSS-bestückt

Z = 3

mech. Vorschub

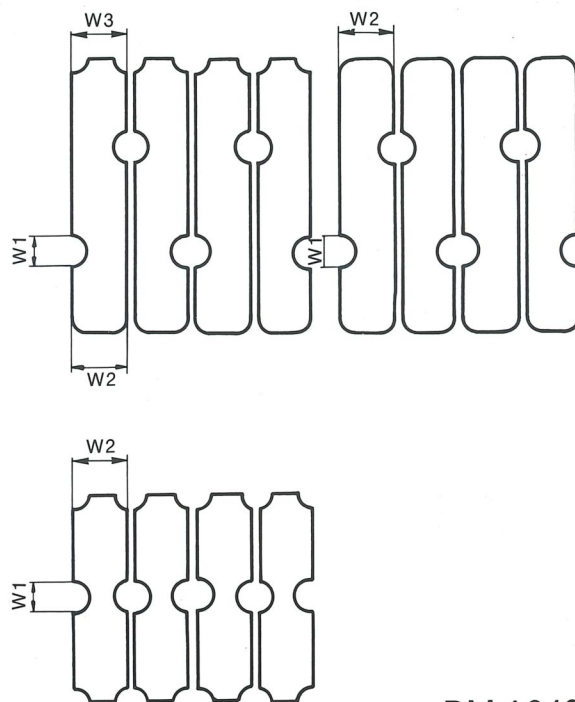
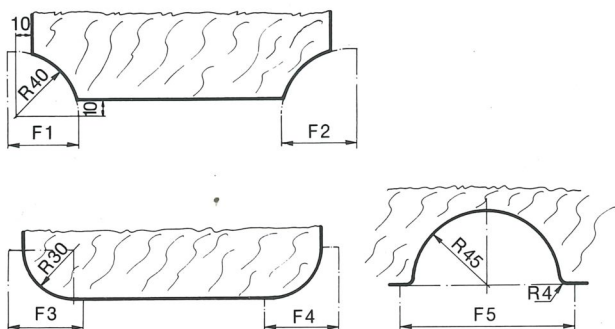

DM 4 040,-

Profil Nr. 9

W1/W2=1. bzw. 2. Werkzeugaufspannung

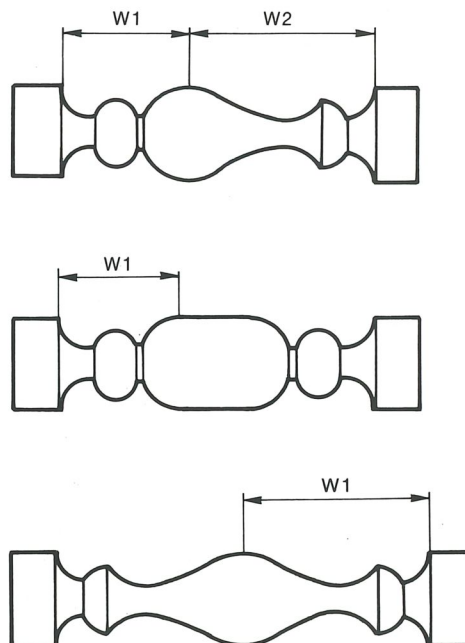
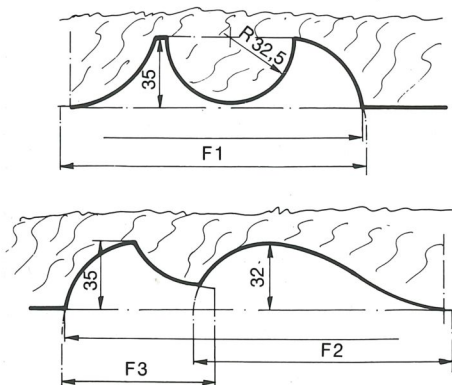

DM 4 290,-

Profil Nr. 10

W1/W2 = 1. bzw. 2. Werkzeugaufspannung

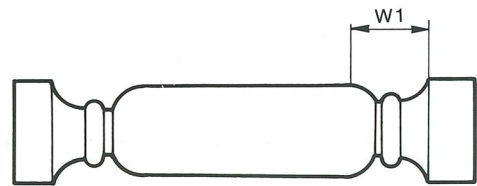
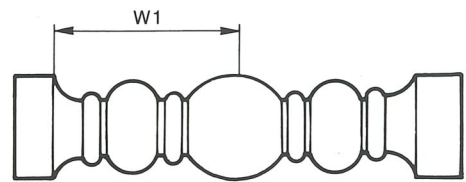
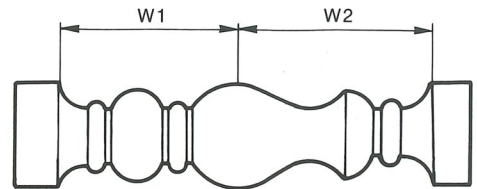
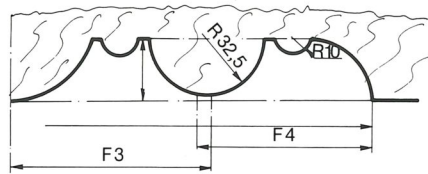
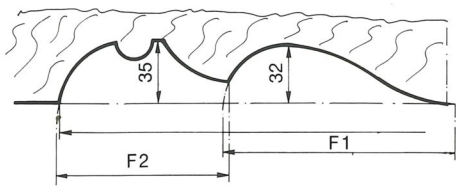

DM 5 120,-

Sonderprofile

Preise auf Anfrage

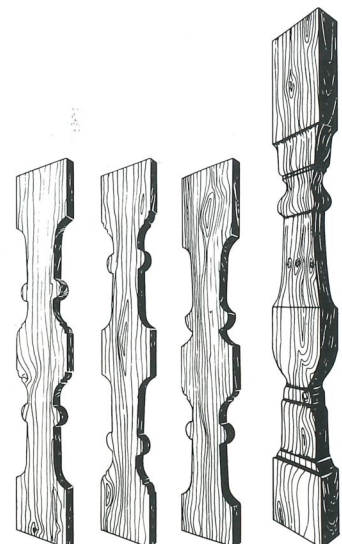
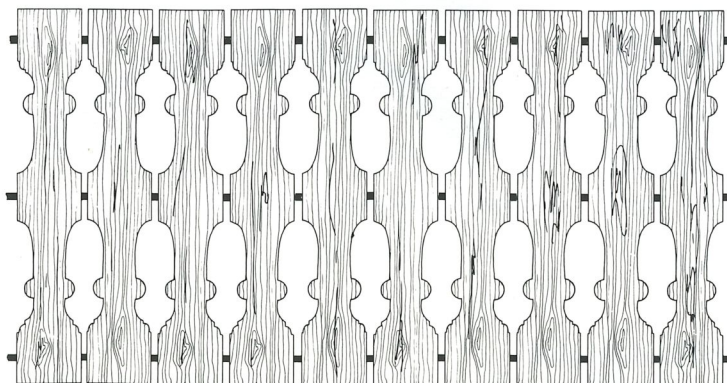

Pr

W1/W

Fräsbeispiele

Vielseitige Fräsbeispiele für Möbelherstellung, Zimmereibetriebe, Holzbauer, Balkon-, Balustraden- und Zaunhersteller und ähnliche Betriebe.

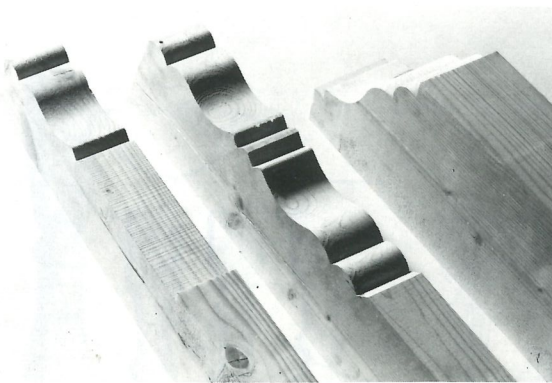
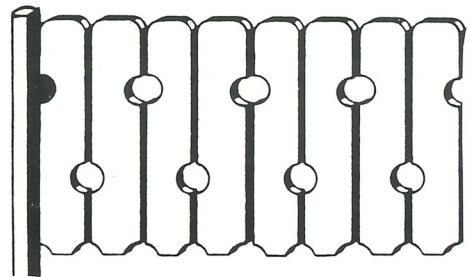
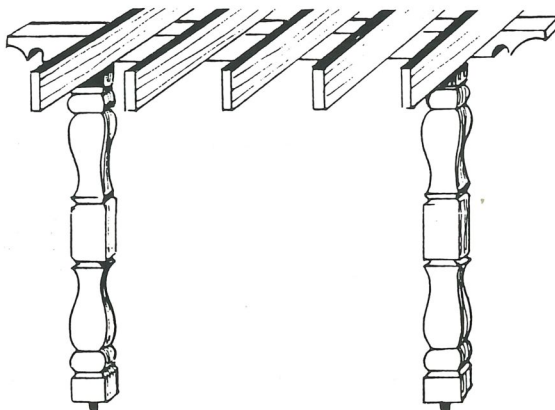
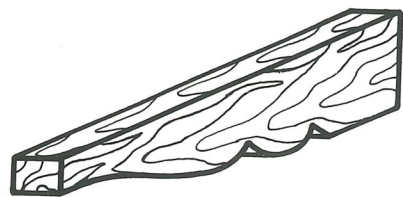
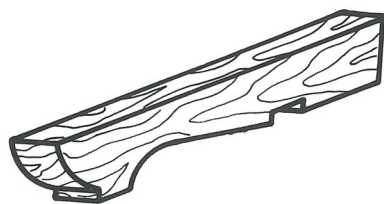
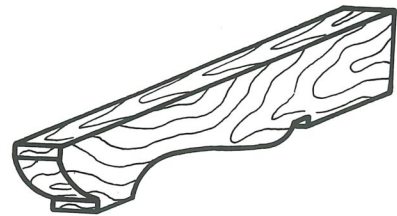
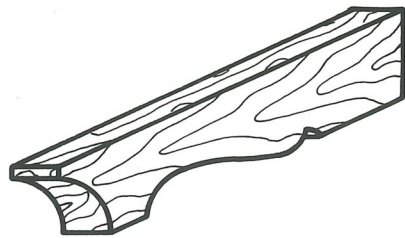

Stirnseitige Bearbeitung von Werkstücken für Dachkonstruktionen (Pergolen). Durch den festen Tisch lassen sich Werkstücke jeder Länge bearbeiten.

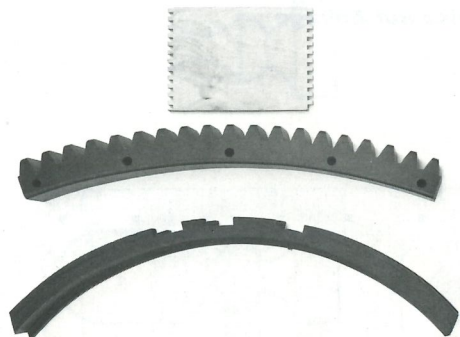

Zahnprofil für Kunststoffteile

**Bitte nennen Sie uns Ihre Profilwünsche.
Wir erarbeiten Ihnen unser ausführliches Angebot.**

BÄUERLE

Profilfräsmaschinen PM 200, PM 250, PM 510

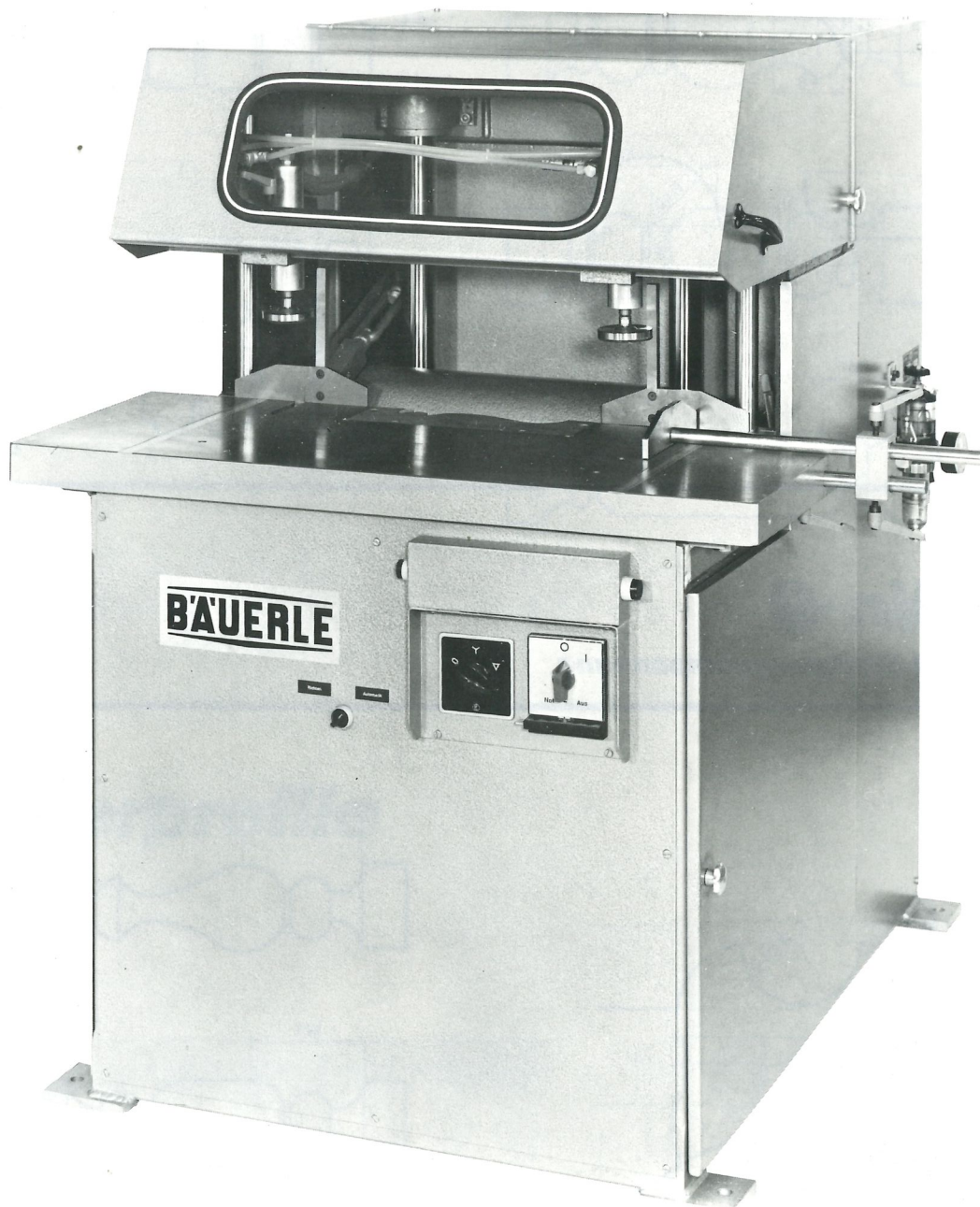

BÄUERLE

BÄUERLE Maschinenfabrik GmbH & Co.
D-7079 Böbingen/Rems · Bahnhofstraße 25 · Postfach 40 · Telefon (071 73) 187-0 · Telex 7248875
Fax (071 73) 187-12 Zentrale · (071 73) 187-11 Einkauf + Ersatzteile