



# TC 3-4

TOP RELIABILITY AND VERSATILITY



NUOVA  
**BULLERI  
BREVETTI**

INDUSTRIAL ART FOR CNC MACHINES  
ITALIAN MADE



NUOVA  
**BULLERI  
BREVETTI**

INDUSTRIAL ART FOR CNC MACHINES  
ITALIAN MADE

# TC 3-4

## TOP RELIABILITY AND VERSATILITY

La serie TC è una linea completamente nuova, curata nel design e tecnologicamente avanzata.

Il ponte chiuso mobile, il piano di lavoro fisso o con barre a ventosa, il sistema gantry e la struttura pesante e affidabilissima: questa macchina risponde perfettamente alle più svariate esigenze e personalizzazioni della clientela per dare forma ad ogni progetto sia nel settore del legno, plastica, alluminio e materiali composti con l'ausilio di teste operatrici a 3 e 4 assi continui.

Il nostro catalogo riporta alcune realizzazioni di macchine con misure e caratteristiche standard, ma non trascuriamo assolutamente ciò che ha caratterizzato in questi anni l'azienda: le macchine speciali realizzate per risolvere i problemi specifici degli utilizzatori.

La serie TC es una línea totalmente nueva. El puente cerrado móvil, la mesa de trabajo fija o con barras de ventosa, el sistema gantry y la estructura pesada y muy fiable: esta máquina es la respuesta perfecta a muchas y diferentes necesidades y personalizaciones de los clientes para realizar cualquier proyecto tan en el sector de la madera, plásticos, como en el del aluminio y materiales compuestos con la ayuda de cabezales operadores de 3 y 4 ejes continuos.

Nuestro catálogo presenta algunas realizaciones de máquinas con medidas y características estándares, pero no deja en absoluto lo que ha caracterizado la empresa en los últimos años: máquinas especiales realizadas para resolver los problemas específicos de los utilizadores.

The TC series is a brand new line.

The movable closed bridge, the fixed or with suction cup rods working top, the gantry system, the heavy and highly reliable structure: this machine is the perfect answer to the most different needs and personalizations of the customers to develop any project in wood, plastic, aluminium and composite materials sectors, with the help of 3 and 4 continuous axes operating heads.

Our catalogue shows some machines produced with standard dimensions and features, but it does not leave out what has been representing the company in the last years: special machines built to solve specific issues of the users.

## BFPM 3013 / 3316 / 3514

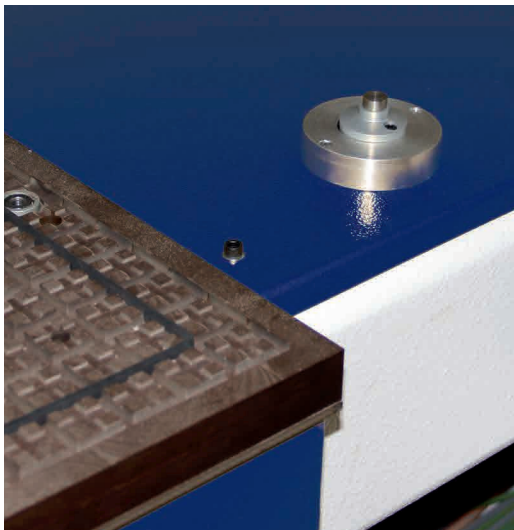
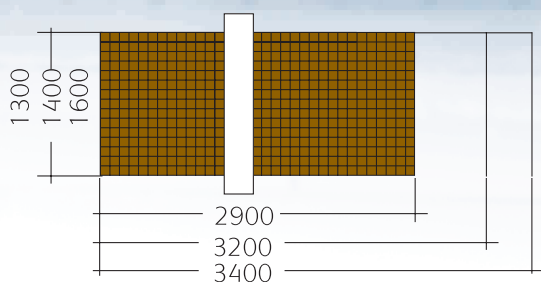
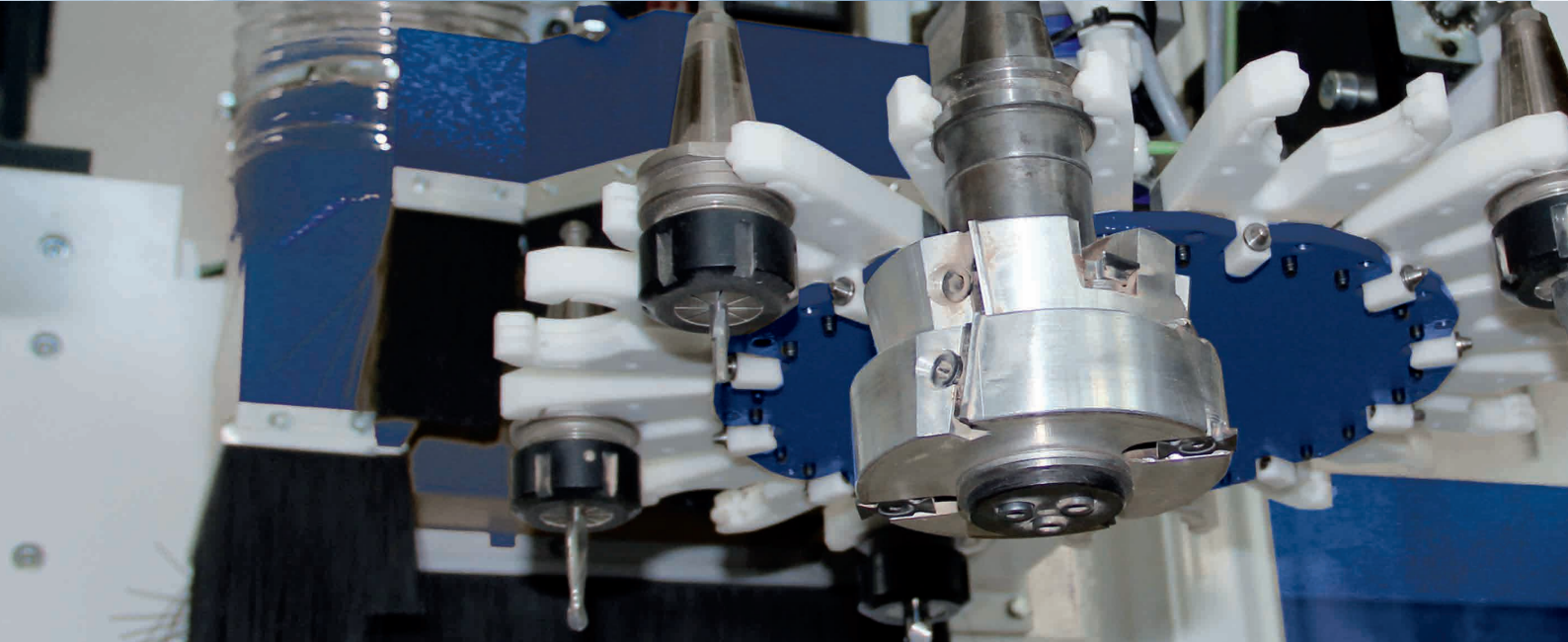

I centri di lavoro TC 3316 sono adatti alla lavorazione del pannello e del massiccio con piano di lavoro a depressione per il bloccaggio del pezzo, movimentazione e scorrimenti per mezzo di guide e pattini di alta precisione e cremagliera a denti doppi inclinati per raggiungere la massima resa e velocità. Una console mobile di ergonomico design aiuta l'operatore nell'impostazione e controllo della macchina per tutto il periodo di lavorazione. Possibilità di montare gruppi separati e continui su attrezzature particolari per lavorazioni nesting di pannelli.

The TC 3316 is a machine which is right for panel and solid wood working with 3200 x 1600 mm working top dipping to lock the piece, it is equipped with gantry movement and related slidings through high precision tracks and blocks and a inclined double-teeth rack to reach the highest output and speed. A movable console with ergonomic design helps the operator in setting out and controlling the machine for the whole working time. Possibility of building divided and continuous groups on special equipments for nesting working of panels.

La TC 3316 es una máquina adecuada para el trabajo de paneles y de duramen con mesa de trabajo de mm 3200 x 1600 a depresión para el bloqueo de la pieza, está equipada con movimentación gantry y relativas circulaciones por medio de guías y patines de elevada precisión y cremallera con dobles dientes inclinados para alcanzar máximos rendimiento y velocidad. Una consola móvil de diseño ergonómico ayuda al operador en la impostación y control de la máquina para todo el tiempo de trabajo. Posibilidad de montar grupos separados y continuos en aparatos especiales para trabajos nesting de paneles.

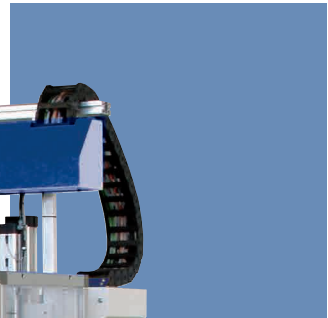
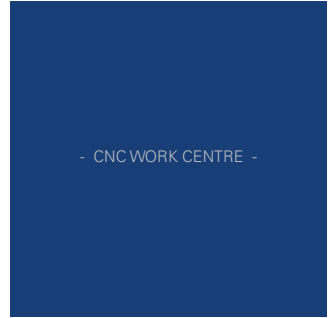

## BFPM GANTRY 3316/ 4316 / 4322 / 5122

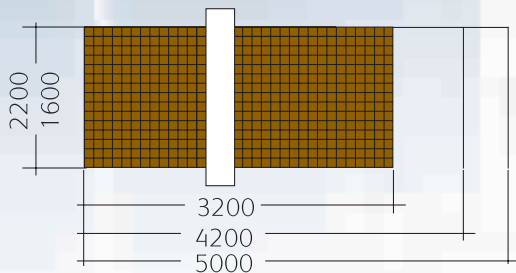
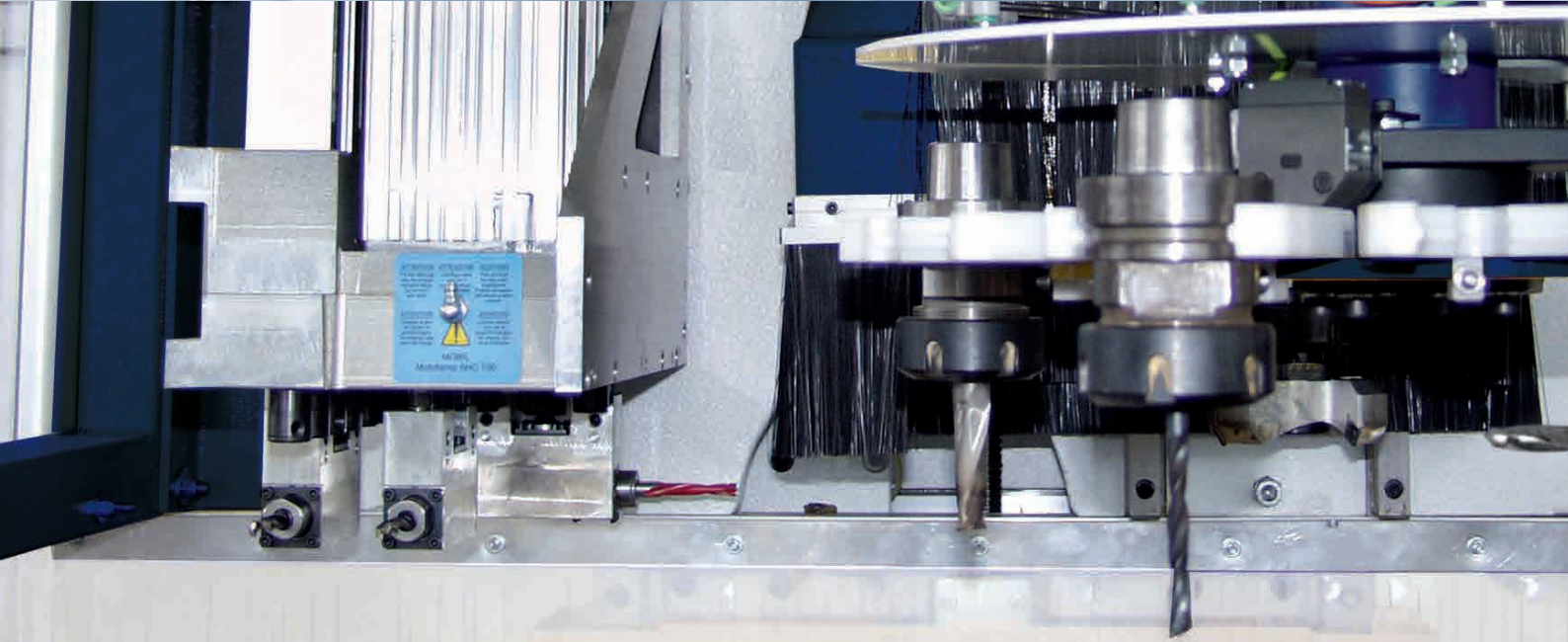

TC 3316 è una macchina adatta alla lavorazione del pannello e del massiccio con piano di lavoro di mm 3200 x 1600 a depressione per il bloccaggio del pezzo, è dotata di movimentazione gantry e relativi scorrimenti per mezzo di guide e pattini di alta precisione e cremagliera a denti doppi inclinati per raggiungere la massima resa e velocità. Una console mobile di ergonomico design aiuta l'operatore nell'impostazione e controllo della macchina per tutto il periodo di lavorazione. Possibilità di montare gruppi separati e continui su attrezzature particolari per lavorazioni nesting di pannelli.

TC 3316 is a machine which is right for panel and solid wood working with 3200 x 1600 mm working top dipping to lock the piece, it is equipped with gantry movement and related slidings through high precision tracks and blocks and a inclined double-teeth rack to reach the highest output and speed. A movable console with ergonomic design helps the operator in setting out and controlling the machine for the whole working time. Possibility of building divided and continuous groups on special equipments for nesting working of panels.

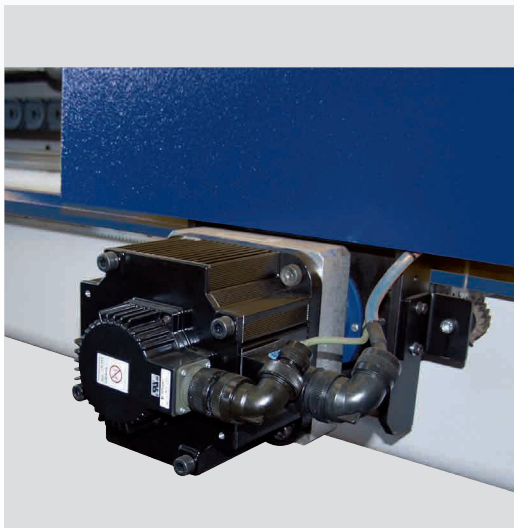

TC3316 es una máquina adecuada para el trabajo de paneles y de duramen con mesa de trabajo de mm 3200 x 1600 a depresión para el bloqueo de la pieza, está equipada con movimentación gantry y relativas circulaciones por medio de guías y patines de elevada precisión y cremallera con dobles dientes inclinados para alcanzar máximos rendimiento y velocidad. Una consola móvil de diseño ergonómico ayuda al operador en la impostación y control de la máquina para todo el tiempo de trabajo. Posibilidad de montar grupos separados y continuos en aparatos especiales para trabajos nesting de paneles.

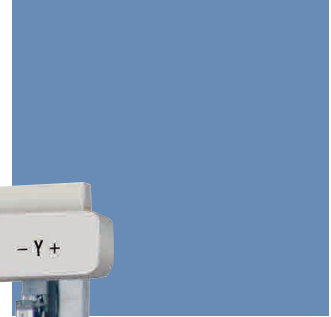
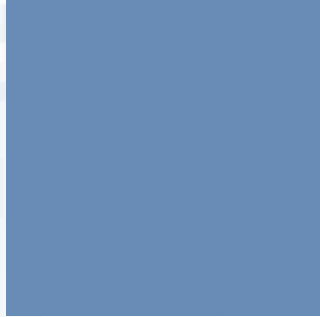
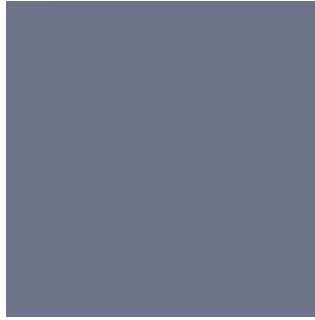
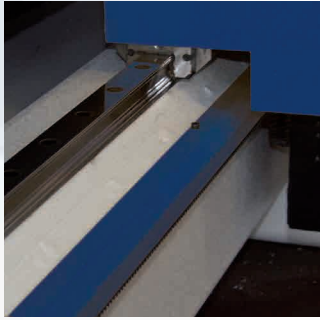
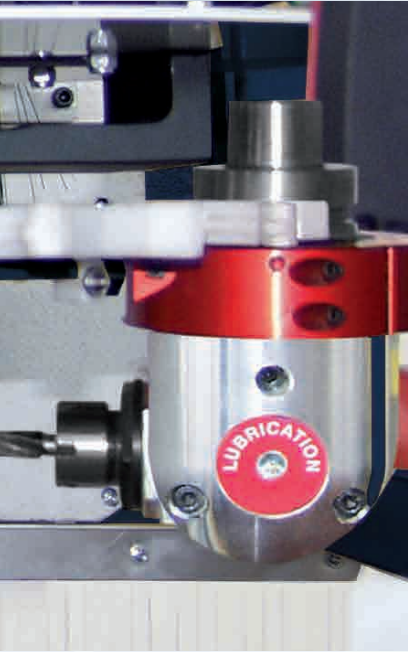

## BFPM NESTING

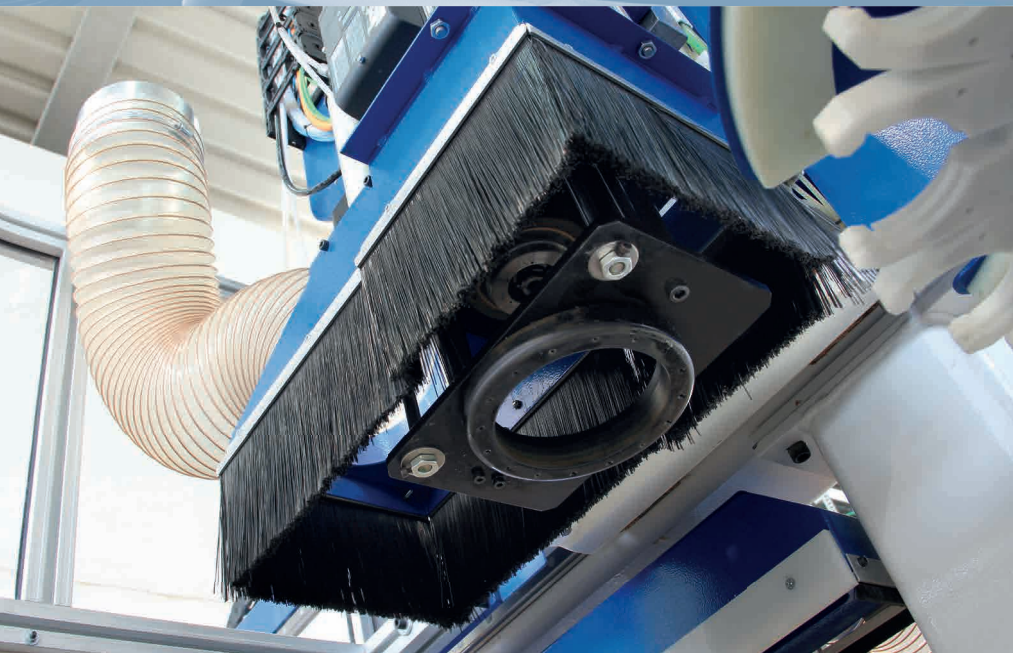

Particolare del pressore per pannelli nesting.

Detail of clamp for nesting panels.

Detalle del prensor para tableros nesting.



Particolare del sistema di aspirazione per pulizia piano.

Detail of aspiration system for cleaning worktable.

Detalle de sistema de aspiracion por limpieza mesa de trabajo.





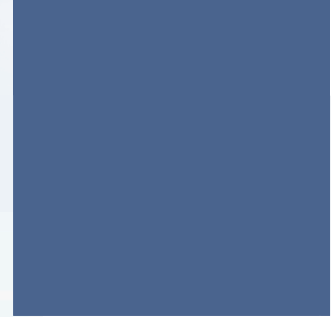
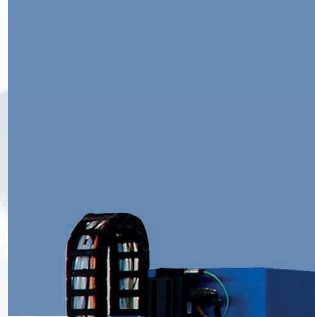
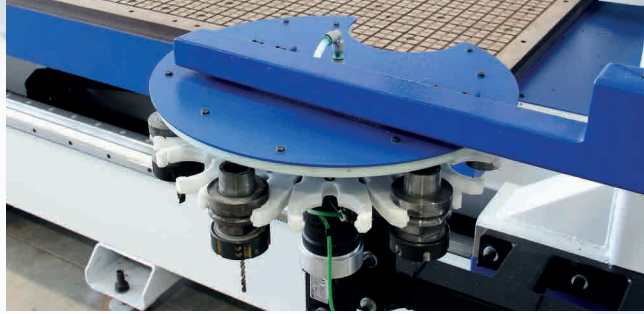
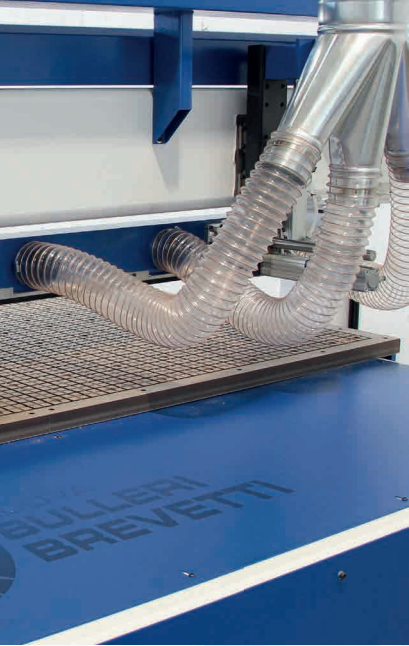

## BFPM 3616



Centro di lavoro per lavorazioni nesting , espressamente studiata per l'ottimizzazione del pannello con tre elettromandrini con interasse variabile, controllato da CNC. La macchina dispone di scaricatore automatico del pannello dopo la lavorazione e sistema di aspirazione posizionato sul retro del ponte mobile per la pulizia del piano di lavoro. I rulli pressori ad interasse regolabile e movimentati per mezzo del ponte mobile bloccano uno o più pannelli sul piano per la lavorazione.

Working center for nesting machining, expressly designed for the optimization of the panel with three electro-spindles with variable center distance, controlled by CNC. The machine has an automatic panel unloader after processing and a suction system positioned on the back of the mobile bridge to clean the worktop. The pressure rollers with adjustable interaxis and moved by the movable bridge, block one or more panels on the work surface.



Centro de trabajo para el mecanizado por nesting, expresamente diseñado para la optimización del tablero con tres mandriles con distancia central variable, controlado por CNC. La máquina tiene un descargador de paneles automático después del procesamiento y un sistema de succión ubicado en la parte trasera del puente móvil para limpiar la superficie de la mesa de trabajo. Los rodillos de presión con interaxis ajustable y movidos por el puente móvil, bloquean uno o más paneles para ser trabajados.

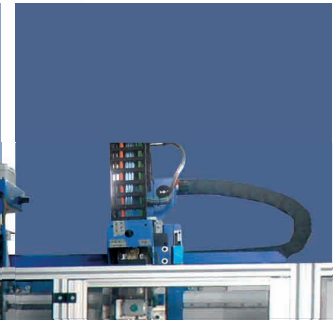
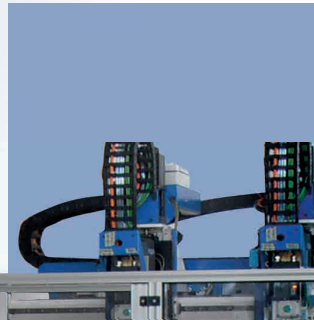
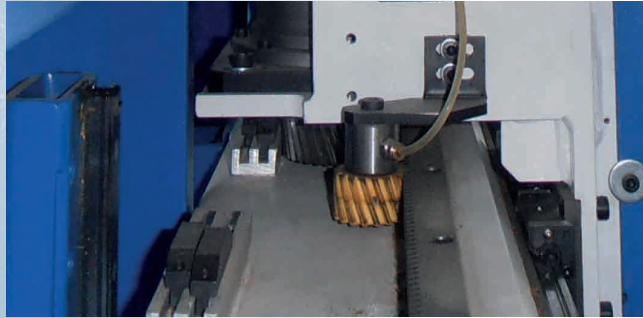

## BFPM 6025

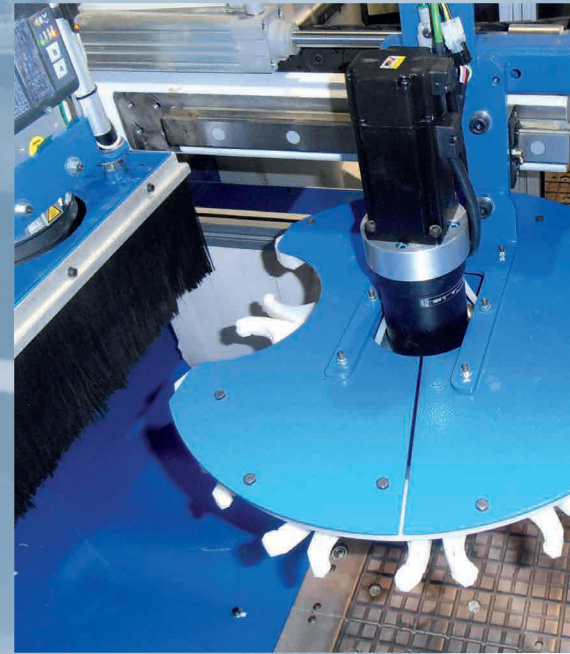
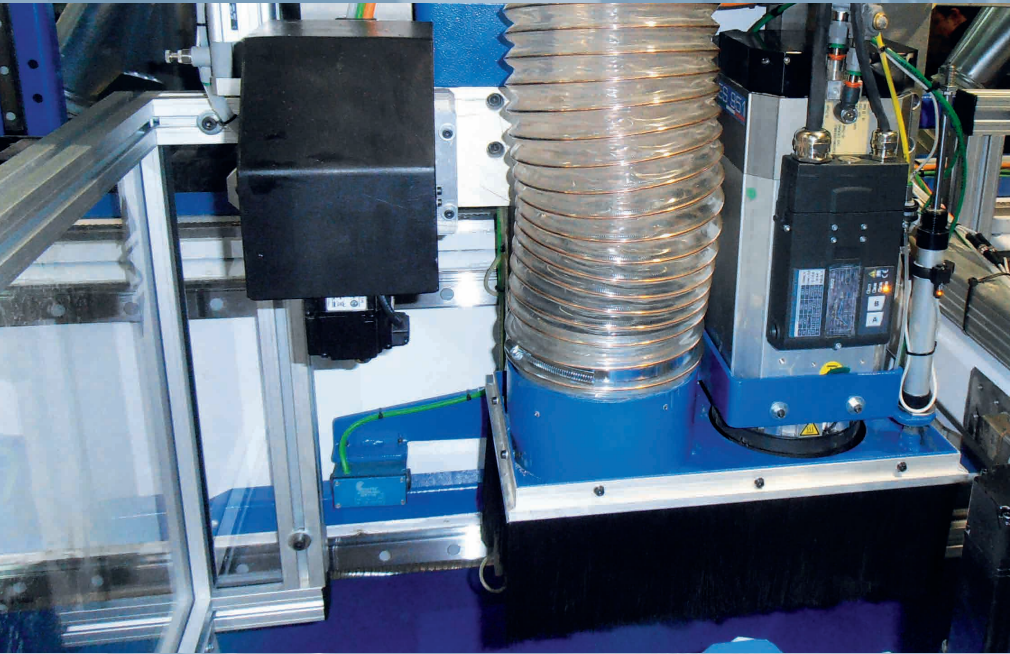

Centro di lavoro in esecuzione speciale con piano da mm 6000 x 2500, progettato per la lavorazione di materiali compositi. La macchina dispone di elettromandrino con cambio utensile automatico trasportato e di gruppo coltellino oscillante per il taglio anche sagomato di pannelli di polistirolo. Dispone di sistema di pulizia automatico del piano, posizionato nella parte posteriore del ponte mobile.

Working center in special execution with a 6000 x 2500 mm worktable, designed for the processing of composite materials. The machine has an electro-spindle with an automatic tool changer and an oscillating knife unit for cutting of polystyrene panels. It has an automatic floor cleaning system, positioned at the back of the mobile bridge.



Centro de trabajo en ejecución especial con una mesa de trabajo de 6000 x 2500 mm, diseñada para el procesamiento de materiales compuestos. La máquina tiene un electromandrill con un cambio automático de herramientas y una unidad de cuchilla oscilante para cortar con cualquier dibujos paneles de poliestireno. Tiene tambien un sistema automático de limpieza de la mesa de trabajo, puesto en la parte trasera del puente móvil.

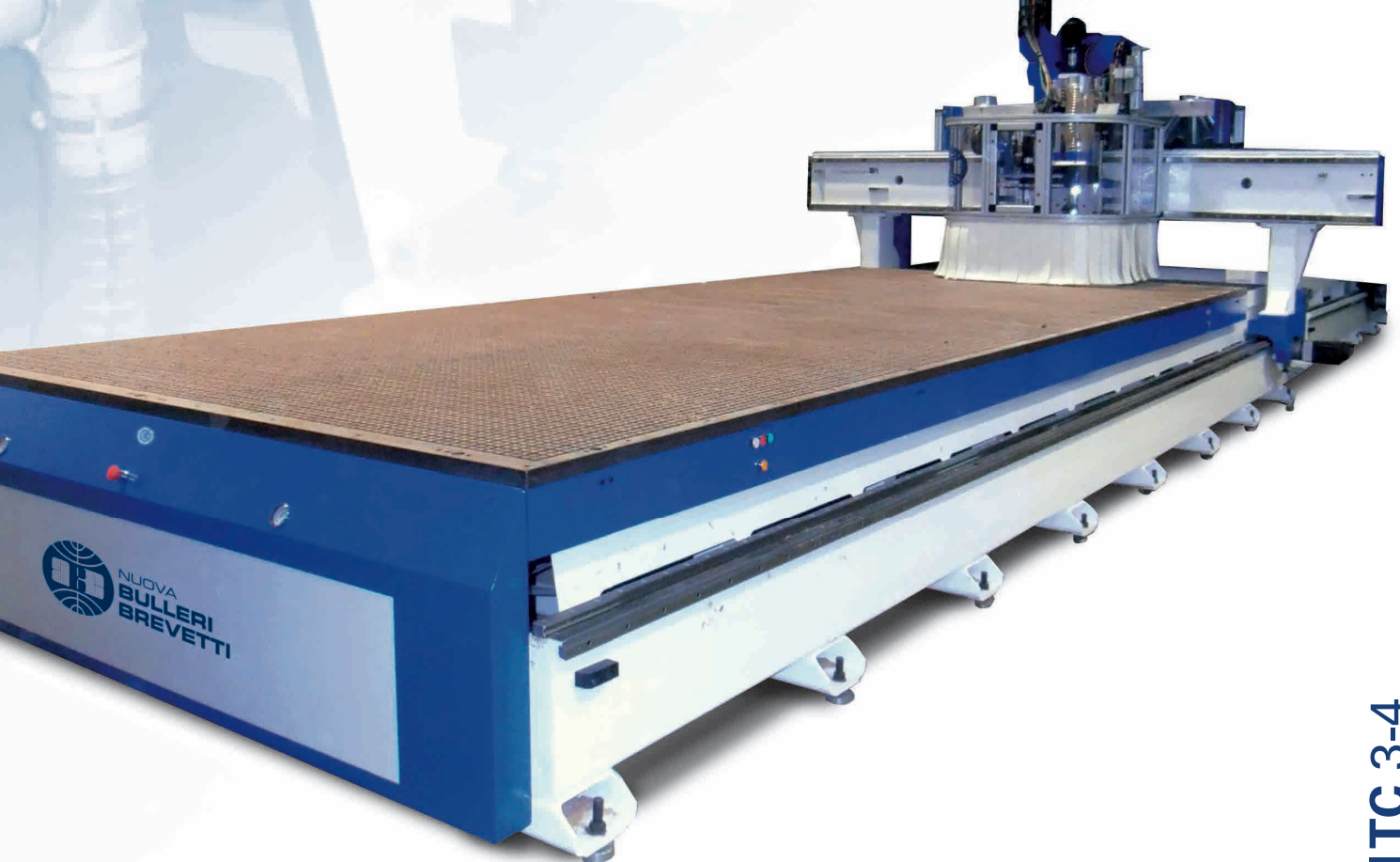
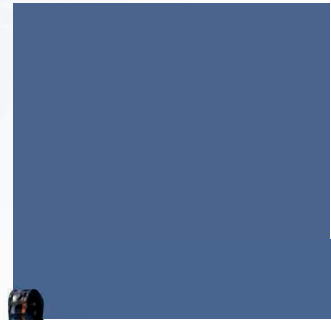
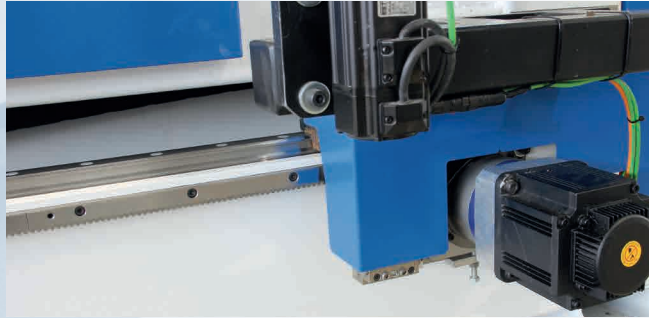

## BFPM 8026

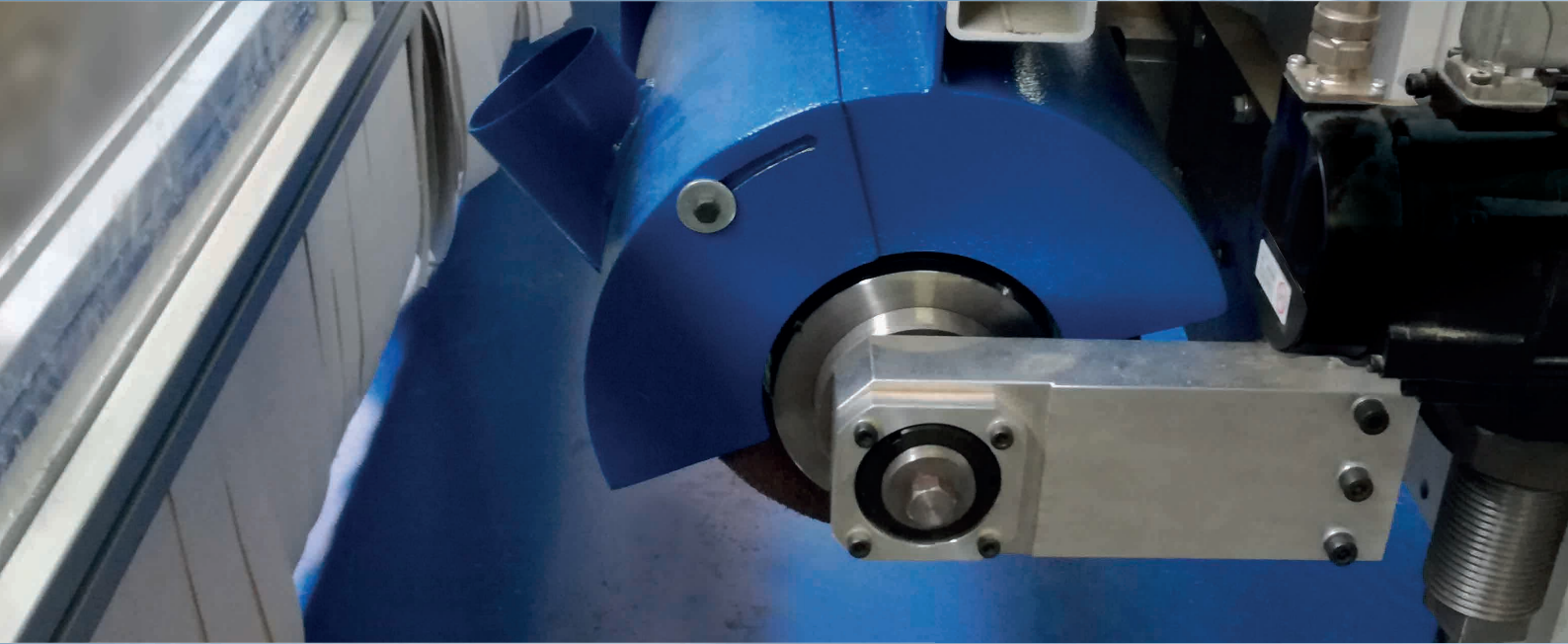

Grande centro di lavoro con piano da mm 8000 x 2600 progettato per lavorazioni di materiali diversi e pannelli di grandi dimensioni. La macchina dispone di elettromandrino con cambio utensile automatico trasportato, N° 3 motori a forare ad alta velocità a richiamo indipendente per micro forature di pareti sottili. Gruppo a rusticare superfici di alluminio e aggregato coltellino oscillante per taglio sagomato di pannelli di polistirolo. Dispone anche di rulli pressori per lavorazioni nesting.

Large working center with 8000x2600 mm worktable designed for processing different materials and large panels. The machine has an electrospindle with automatic tool changer and transported, N° 3 high-speed drilling motors with independent return for micro-holes in thin walls. Group to rusticize aluminum surfaces and aggregate swinging knife for shaped cutting of polystyrene panels. It also has press rollers for nesting.

Centro de grandes dimensiones con mesa de trabajo de mm 8000 x 2600 diseñada para procesar diferentes materiales y grandes paneles. La máquina tiene un electromandril con cambio automático de herramientas transportado, grupo de taladro con tres motores de alta velocidad independiente para microagujeros en paredes delgadas. Un grupo para rusticar (embejecer) las superficies de aluminio el agregado con cuchillo oscilante para cortes en forma de paneles de poliestireno. También tiene rodillos de presores para trabajos nesting.



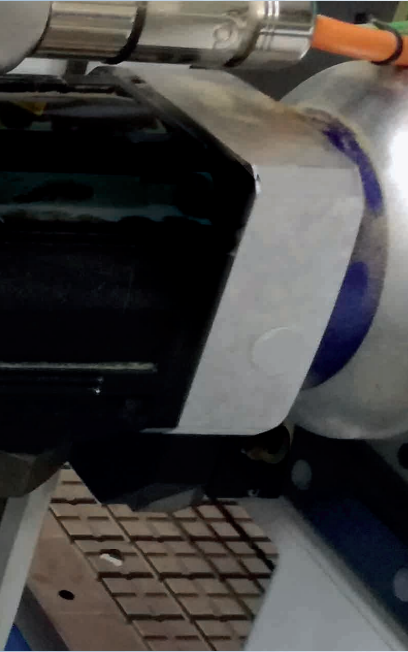

## BFPM 4016 VS

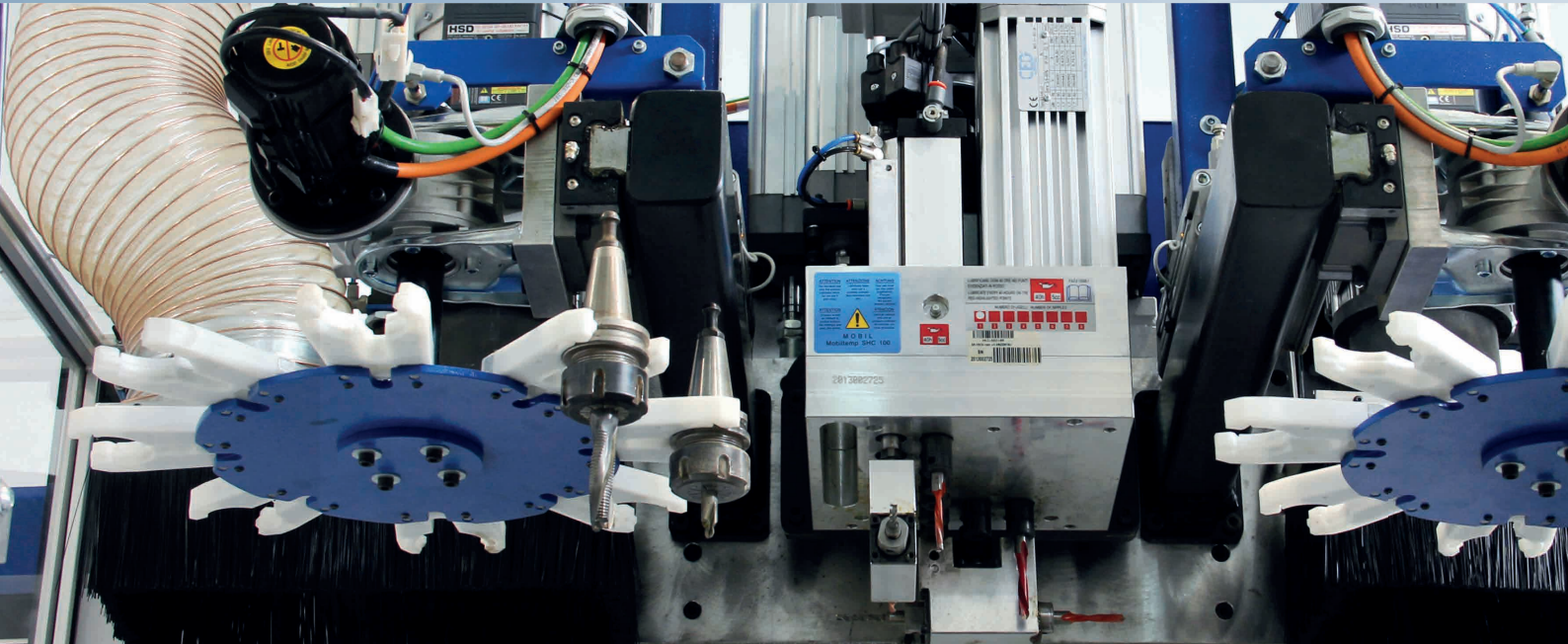

Centro di lavoro BFPM 4016 VS, nasce per l'esigenza del cliente di dover lavorare porta e finestra ancora da assemblare, con relativi archi ed infissi in generale. La macchina è realizzata con ponte chiuso mobile, sistema di movimentazione gantry e barre mobili con ventose. È presente sulla testa operatrice il motore orizzontale a doppie uscite contrapposte, elettromandrino e cambio utensile automatico; mentre, applicate sulle barre vi sono le relative morse per il bloccaggio dei serramenti.

BFPM 4016 VS working centre, born for the client's need of working doors and windows yet to assemble, with arches and shutters.

The machine is built with movable closed bridge, gantry movement system and movable rods with suction cups. On the operating head, the horizontal motor with double opposing exits, electrospindle and automatic toolchanger; applied on the rods you can find the related grips for locking doors and windows.

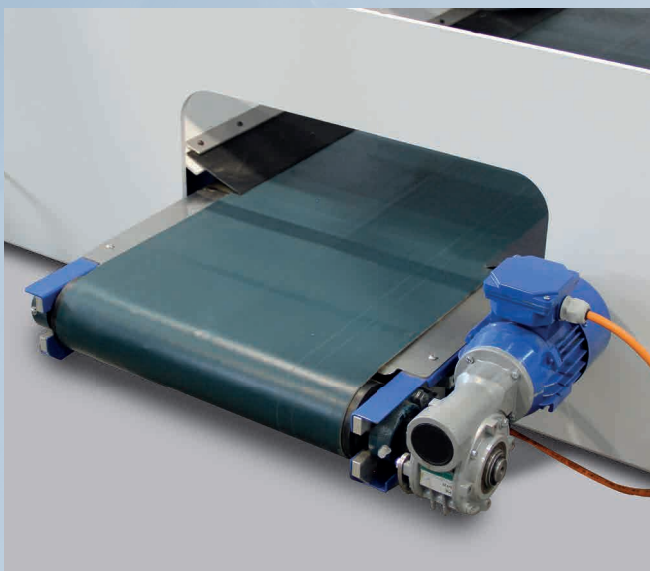

Centro de trabajo BFPM 4016 VS, que nace por la necesidad del cliente de trabajar puertas y ventanas aún por montar, con relativos arcos y contraventanas en general.

La máquina se realiza con puente cerrado móvil, sistema de movimentación gantry y barras móviles con ventosas. Sobre el cabezal operador se encuentra el motor horizontal con dobles salidas opuestas, electromandrill y cambio utensil automático; mientras, aplicadas en las barras, están las relativas morsas para el bloqueo de las ventanas.



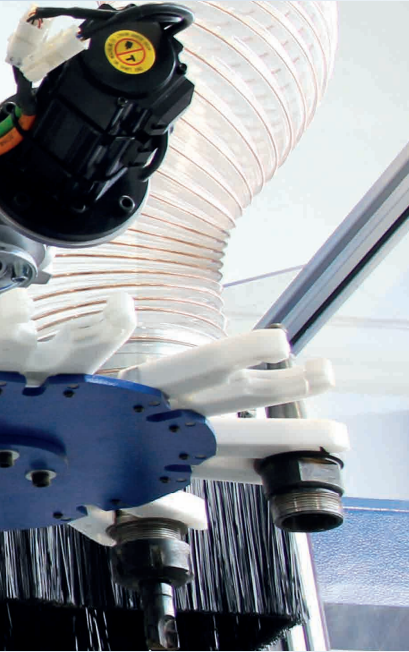

## BFPM PORTE 6613

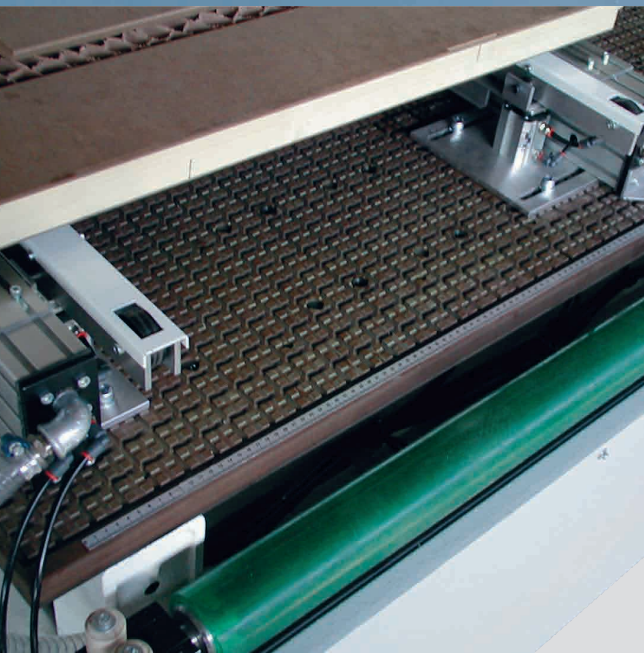

Piano di lavoro attrezzato per la lavorazione di porte con ventose lunghe regolabili in larghezza e nastro trasportatore manuale o motorizzato.

Worktable equipped for doors with long suction cups adjustable in width and manual or motorised conveyor belt.

Mesa de trabajo equipada para trabajar puertas, con ventosas largas regulables en altura y correa transportadora manual o motorizada.

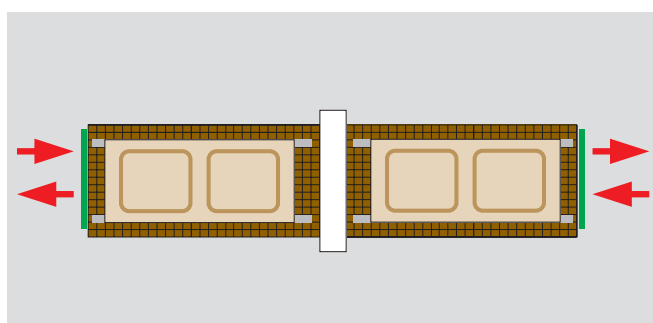

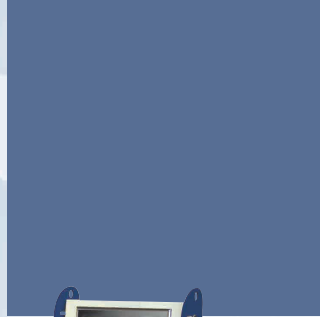

Elettromandrino con movimentazione 0°/90° da CN

Electrospindle with 0°/90° CN movement

Electromandril con movimentación 0°/90° de CN

Gruppo girevole da CN con lama e punta per lavorazione telai di porte

Rotating group with blade and milling cutter for working doors chassis

Grupo giratorio de CN con sierra y punta para trabajo de marcos de puertas

Gruppo anubatrice per anuba singola e doppia con pinza universale

Anuba group for single and double anuba with universal grab

Grupo anubadora para anuba individual y doble con pinza universal

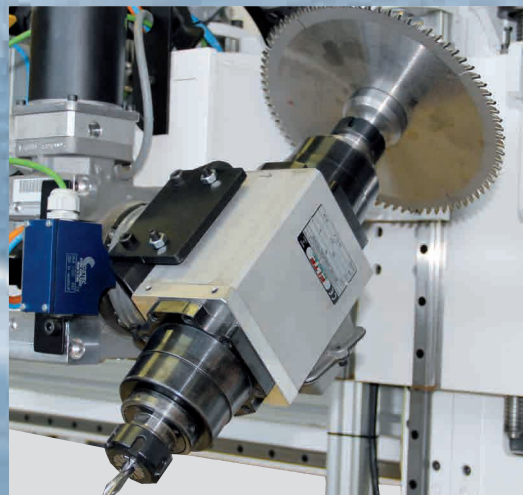

## BFPM Porte Concept



Visione d'insieme dei gruppi operatori  
Group of operating units  
Conjunto de grupos operadores

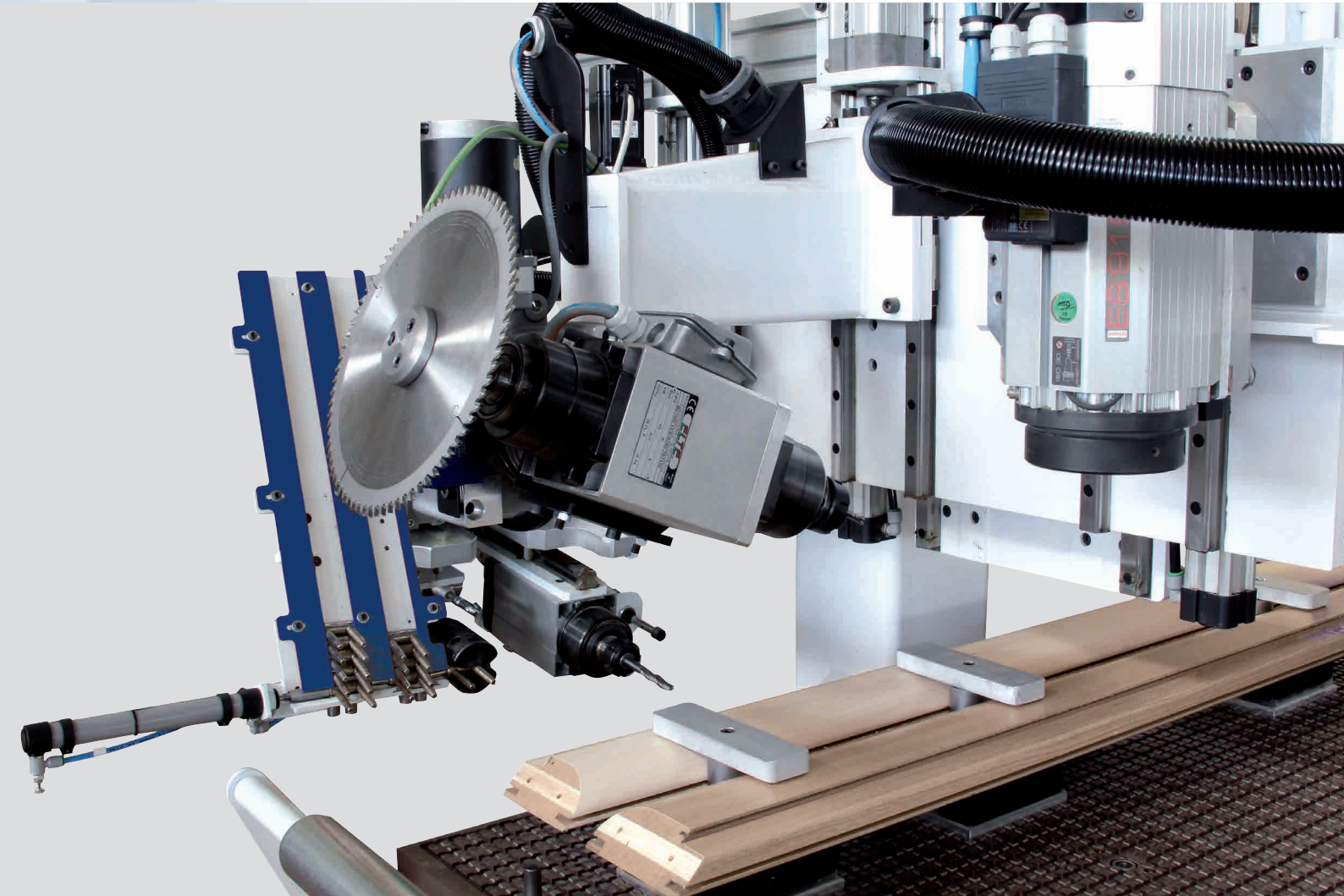

Piano attrezzato con morse pneumatiche per bloccaggio telai di porte e affini (particolare)

Mesa con morsa neumáticas para bloqueo de marcos de puertas y similares (particular)

Top equipped with pneumatic clamps for locking doors chassis and suchlike (detail)



## BFPM 3013 Linea Porte

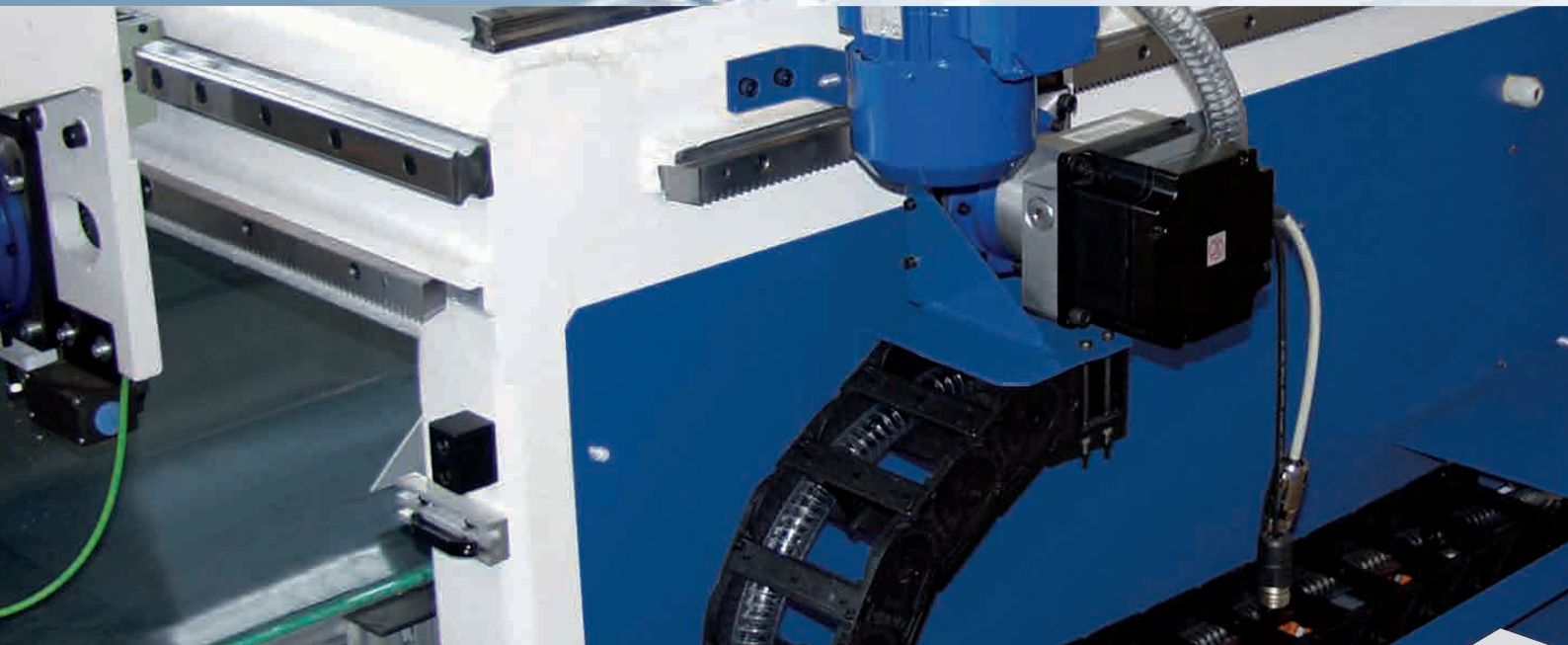

Fresatrice a CN progettata per la realizzazione di porte interne, può lavorare singolarmente oppure inserita in una linea di produzione perché il ciclo è completamente automatico. La macchina è dotata di nastri trasportatori per la movimentazione della porta e di un tappeto per l'evacuazione degli sfridi di lavorazione e di ventose scorrevoli. Sulla testa operatrice sono presenti un elettromandrino ad alta potenza e velocità ed un magazzino cambio utensile per poter così diminuire ulteriormente i tempi di lavorazione.

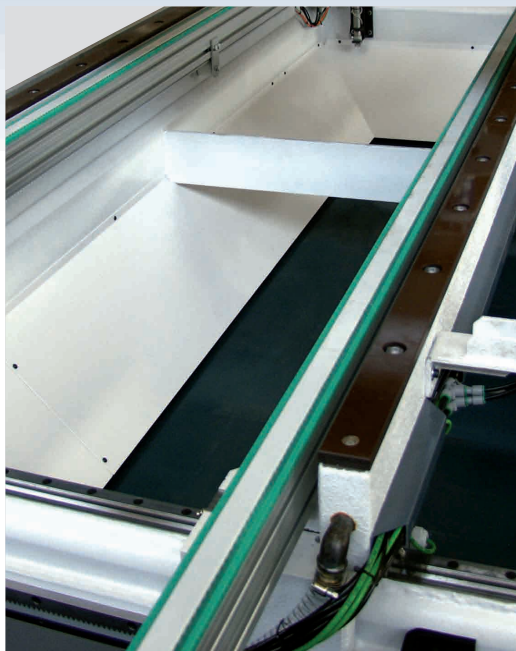

CN milling machine projected for the creation of interior doors, it can work separately or included in a production line because the cycle is totally automatic. The machine is equipped with conveyer belts for the door movement, with a carpet for the evacuation of the scraps during the working and with sliding suction cups. On the operating head there are a high power electrospindle and a toolchanger necessary to further reduce the working times.

Fresadora de CN proyectada para la realización de puertas interiores, puede trabajar singolarmente o incluida en una línea de producción porque el ciclo es completamente automático. La máquina está equipada con cintas transportadoras, para la movimentación de la puerta, y con un alfombra, para la evacuación de virutas de elaboración, y de ventosas corredizas. En el cabezal operador están un electromandrino con elevada potencia y velocidad y un almacén cambio utensil para poder así reducir ulteriormente los tiempos de trabajo.



- CNC WORK CENTRE -

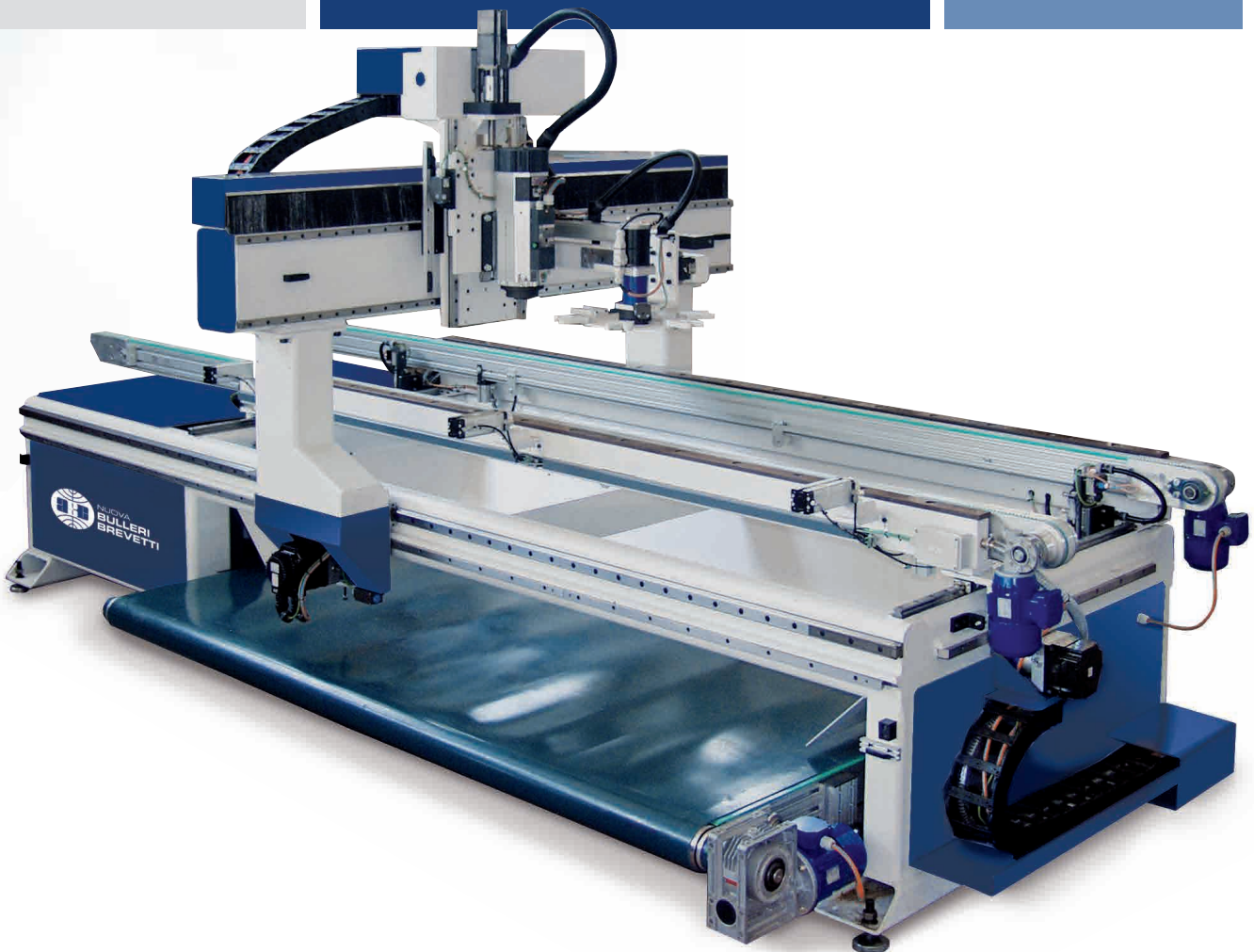
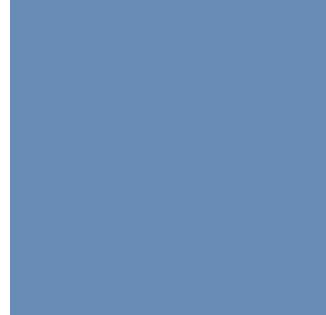

## BFPM INFISSI



Particolare delle barre mobili ad alta prevalenza di vuoto con ventose montate.

Detail of mobile bars with high vacuum prevalence with mounted vacuum cups.

Detalle de barras móviles con alta prevalencia de vacío con ventosas montadas.





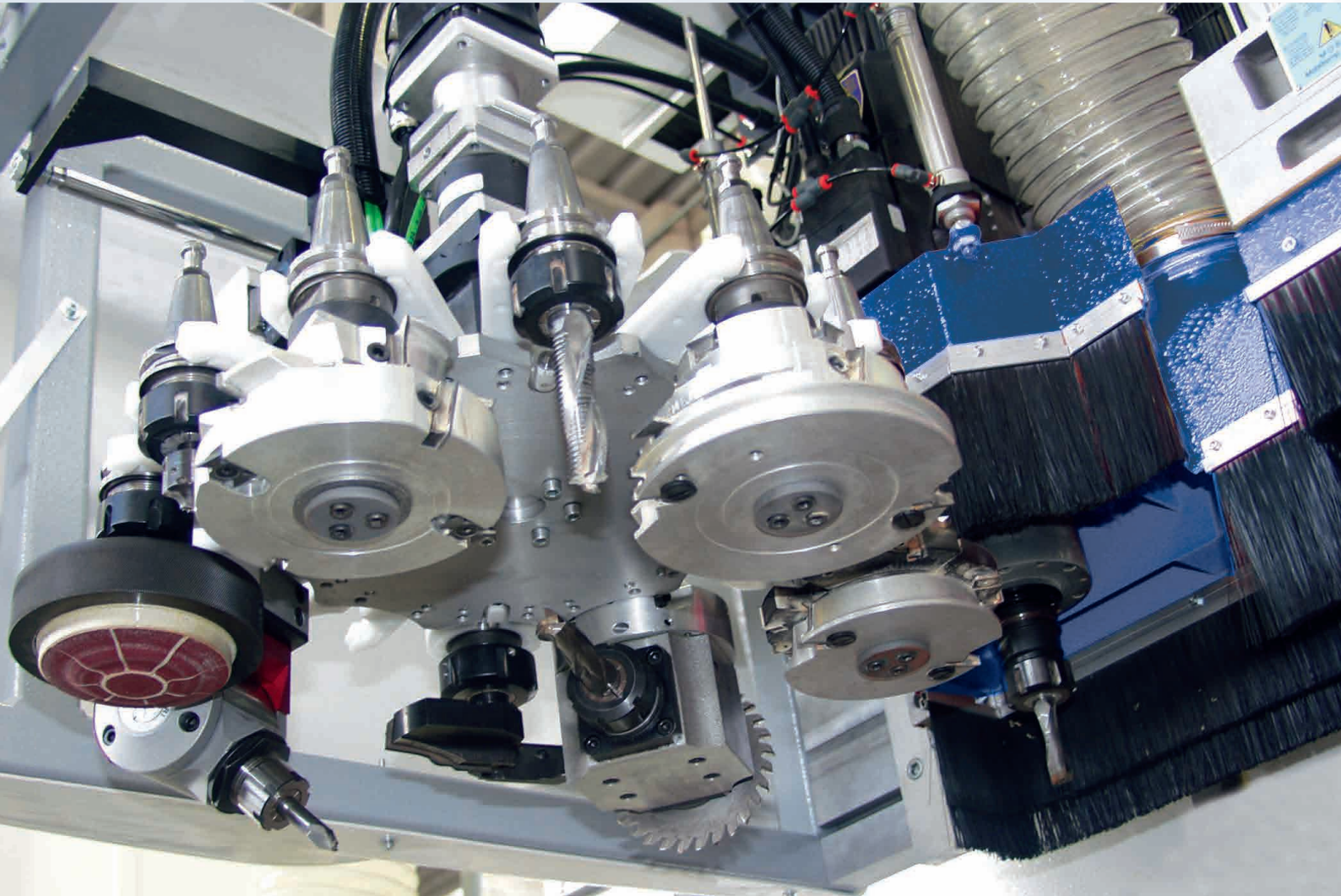

Cambio utensile attrezzato per la lavorazione di infissi in legno.  
Tool change equipped for working wood frames.  
Cambio de herramientas equipado para trabajar bastidores de madera.





Gruppo orizzontale per fresare e forare a 2 uscite con movimento 0°/90°/180° oppure 360° in continuo da CNC.

Horizontal unit for routing and drilling with 2 exits with 0°/90°/180° or 360° continuous movement from CNC.

Grupo horizontal para fresar y taladrar de 2 salidas con movimiento 0°/90°/180° o bien 360° en continuo desde CNC.

Le nostre teste a forare con mandrini a richiamo indipendente da 7 mandrini verticali e 4 orizzontali fino a 18 mandrini verticali e 6 orizzontali con oppure senza lama circolare fissa o indexata.

Our drilling heads with independently operating spindles, from 7 vertical and 4 horizontal spindles up to 18 vertical and 6 horizontal spindles, with or without fixed or indexed circular blade.

Cabezales de taladro con mandriles de llamada independientes, posibilidad de tener desde 7 mandriles verticales y 4 horizontales hasta 18 mandriles verticales y 6 horizontales, con o sin sierra circular fija o indexada.

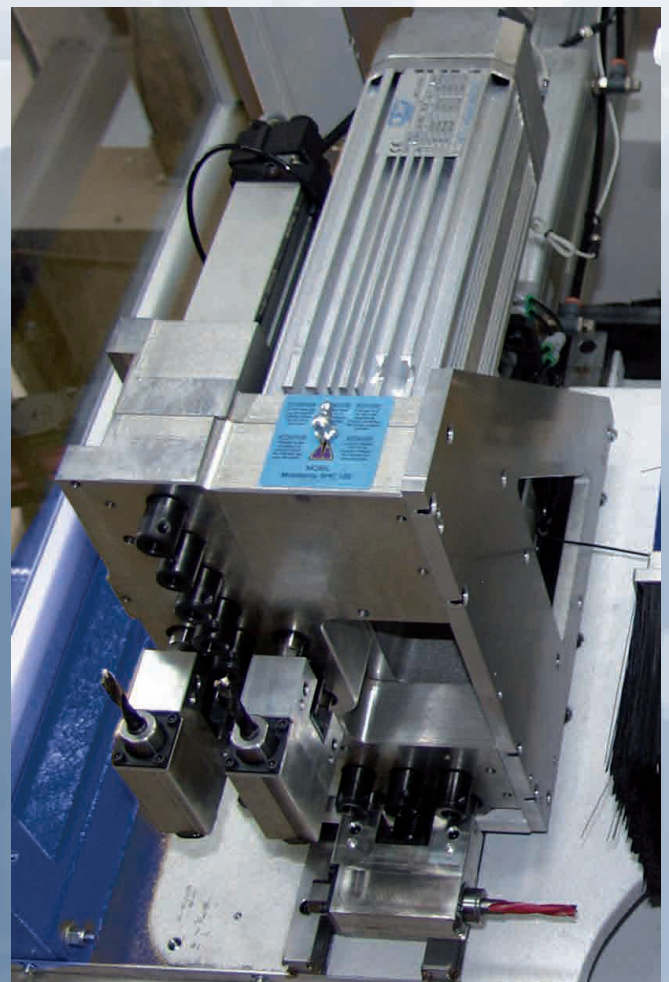

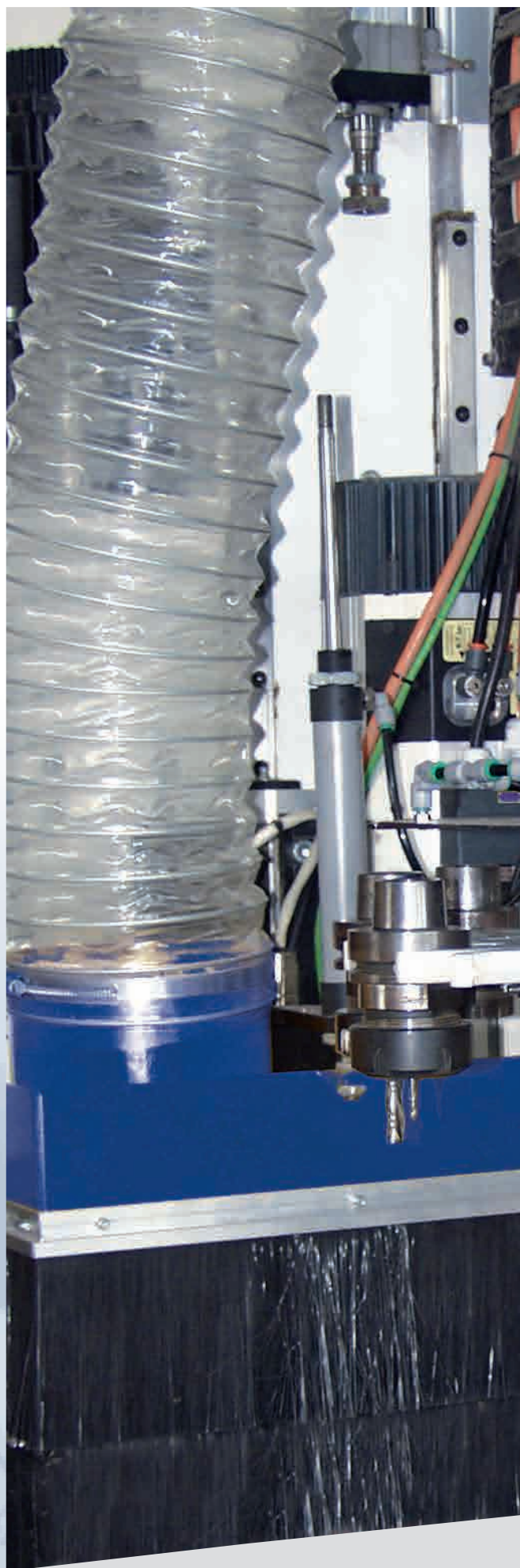

Motore dotato di asse C (Rotor) 360° in continuo con cambio utensile automatico attacco HSK F63.

Motor featuring continuous axis C (Rotor) 360° with automatic tool change. HSK F tool holder.

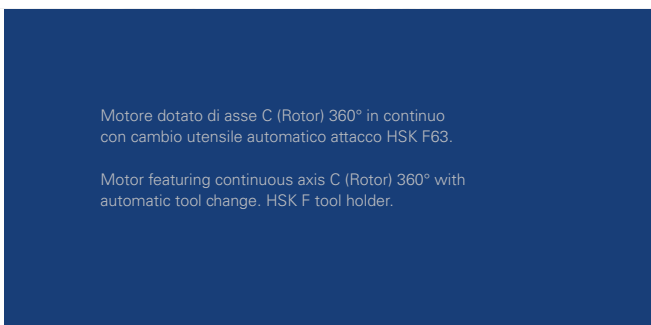



Cambio utensile automatico girevole con attacchi utensili HSKF63 o ISO30 montato su elettromandrino.

Automatic swivel tool change with tool chucks HSKF63 or ISO30 mounted on electric spindle.

Cambio de herramienta automático giratorio con empalmes para herramientas HSKF63 o ISO30 montado en electro-mandril.



Cambio utensile automatico girevole con attacchi utensili HSKF63 o ISO30 montato su colonna scorrevole.

Automatic swivel tool change with tool chucks HSKF63 or ISO30 mounted on sliding column.

Cambio de herramienta automático giratorio con empalmes para herramientas HSKF63 o ISO30 montado en columna corredera.

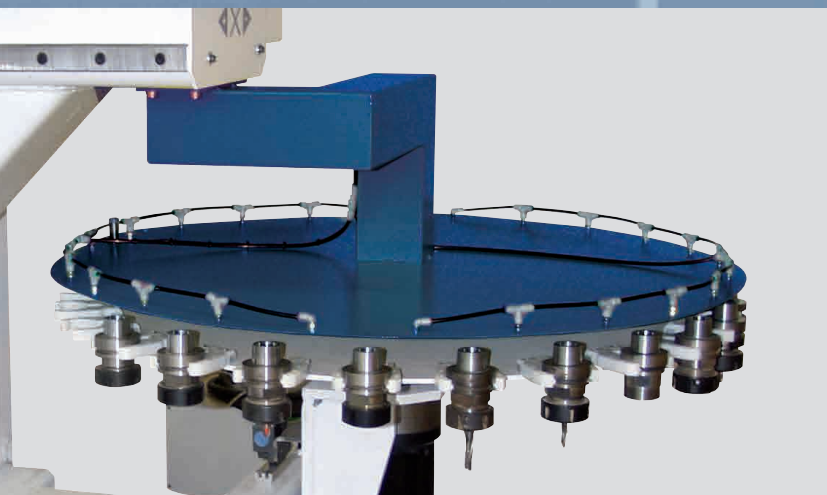

Cambio utensile automatico girevole con attacchi utensili a 24 posizioni.

Automatic swivel tool change with 24-position tool chucks.

Cambio de herramienta automático giratorio con empalmes para herramientas de 24 posiciones.

- POSSIBILI EQUIPAGGIAMENTI
- FURTHER EQUIPMENTS

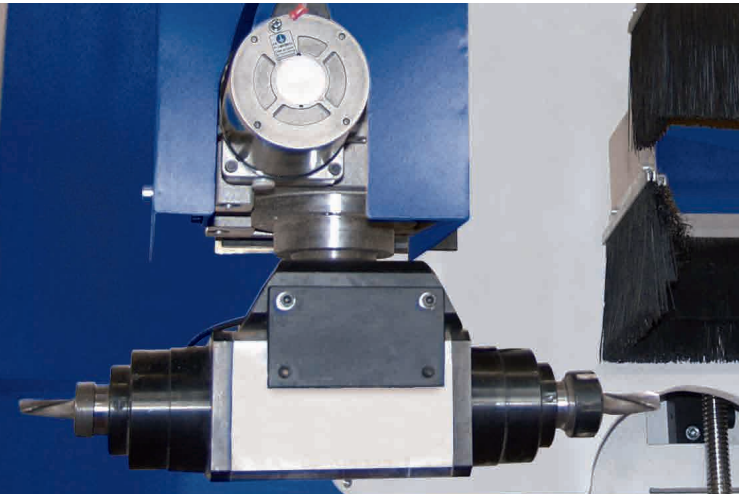

Gruppo orizzontale a 2 uscite con posizionamento da CNC  $0^{\circ}/90^{\circ}/180^{\circ}$  per lavorazioni di serrature, piastrine e lavorazioni varie di telai.

2-outfeed horizontal unit with  $0^{\circ}/90^{\circ}/180^{\circ}$  positioning from CNC for working locks, plates and miscellaneous frame operations.

Grupo horizontal de 2 salidas con posicionamiento por CNC  $0^{\circ}/90^{\circ}/180^{\circ}$  para realizar cerraduras, placas y diferentes trabajos en bastidores.

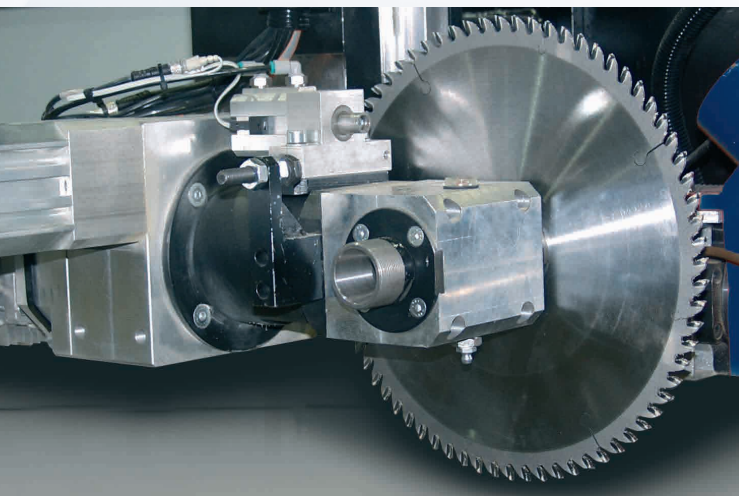

Gruppo lama inclinabile con movimento pneumatico da CNC con  $0^{\circ}\pm 45^{\circ}$  per lavorazione telai.

Tilting blade unit with  $0^{\circ}\pm 45^{\circ}$  pneumatic movement from CNC for machining frames.

Grupo hoja inclinable con movimiento neumático por CNC con  $0^{\circ}\pm 45^{\circ}$  para trabajar bastidores.

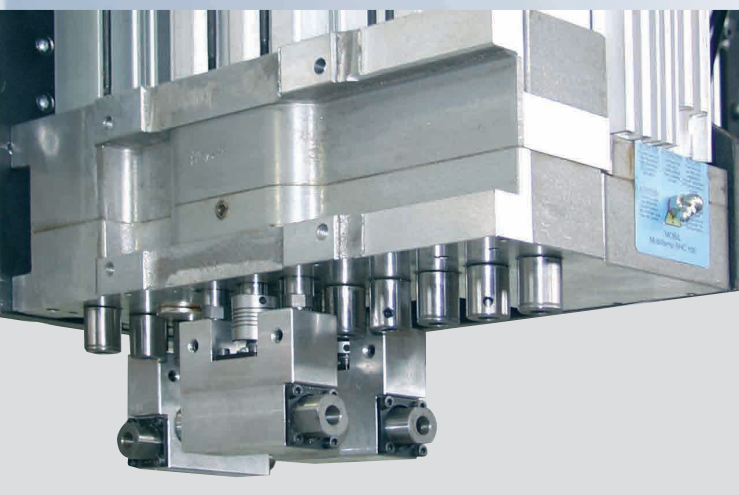

Teste a forare punto punto con mandrini indipendenti.

Point point drilling heads with independent spindles.

Cabezales de taladrado punto a punto con mandriles independientes.



NUOVA  
BULLERI  
BREVETTI

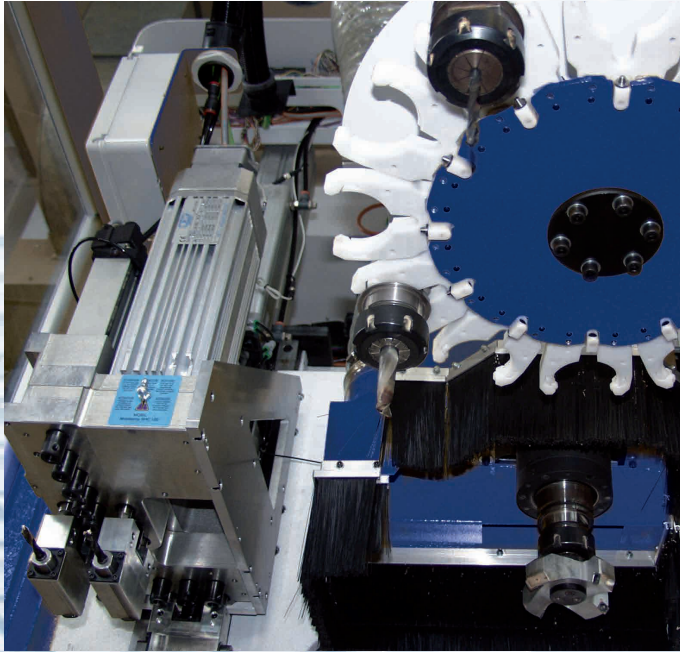

Composizione testa per arredamento.  
Head composition for furnishings.  
Composición de cabezal para mobiliario.

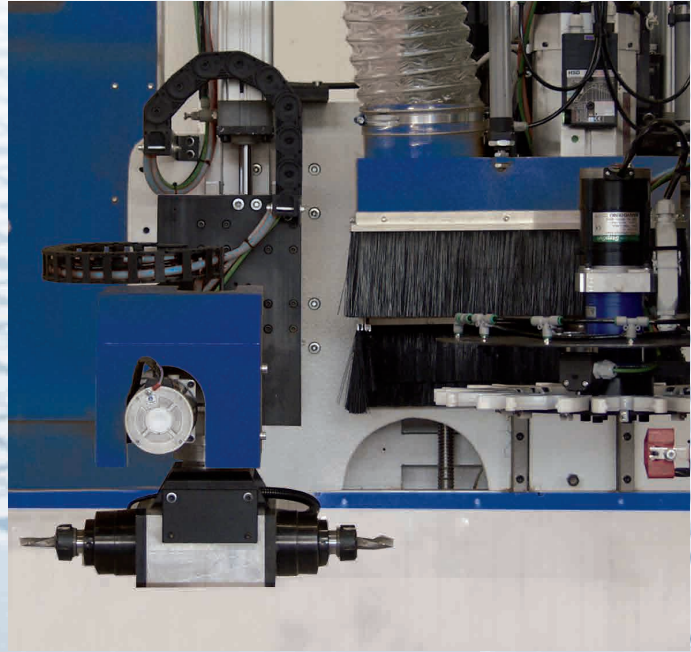

Composizione testa per porte.  
Head composition for doors.  
Composición de cabezal para puertas.

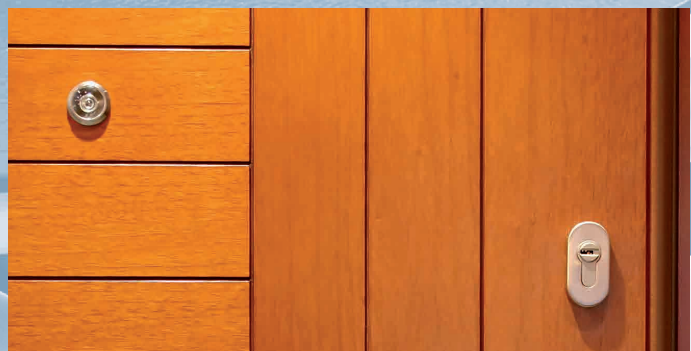

- COMPOSIZIONI SPECIFICHE GRUPPI

- SPECIFIC GROUPS COMPOSITIONS

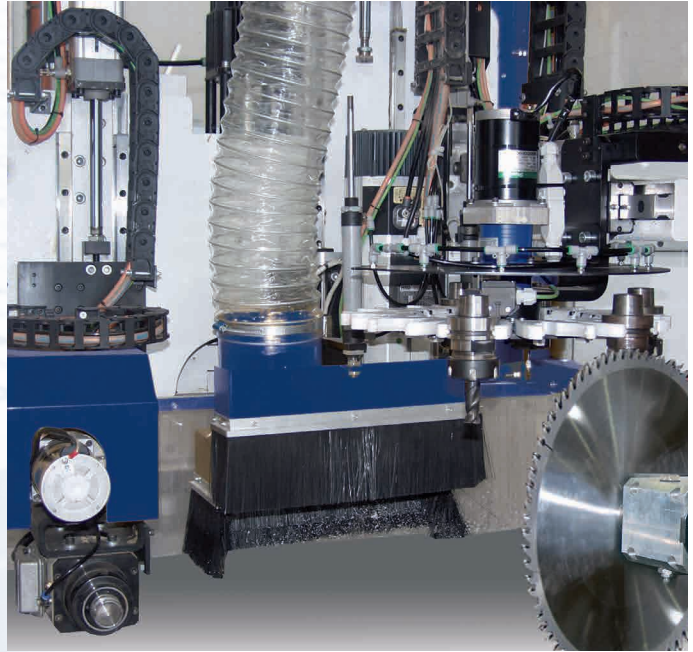
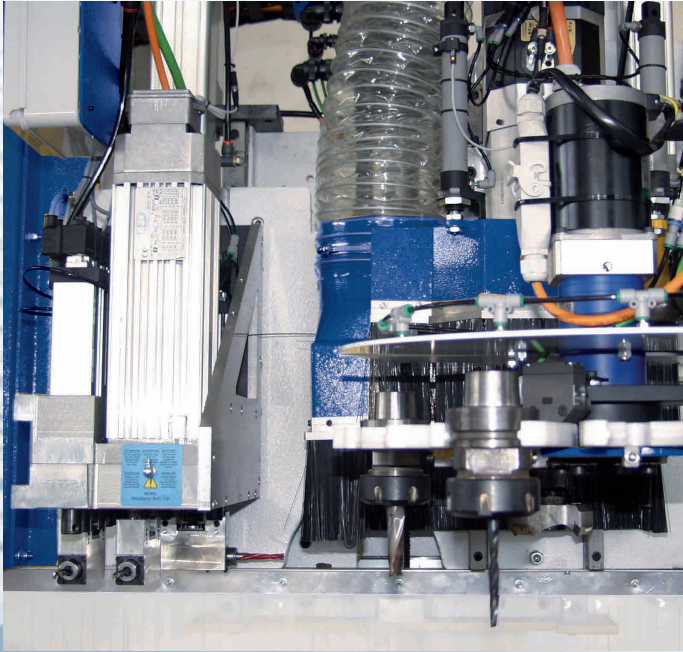

Composizione testa per porte e arredamento.  
Head composition for doors and furnishings.  
Composición de cabezal para puertas y mobiliario.

Composizione testa per porte, telai e finestre ad arco.  
Head composition for doors, frames and arch windows.  
Composición de cabezal para puertas, bastidores y ventanas de arco.

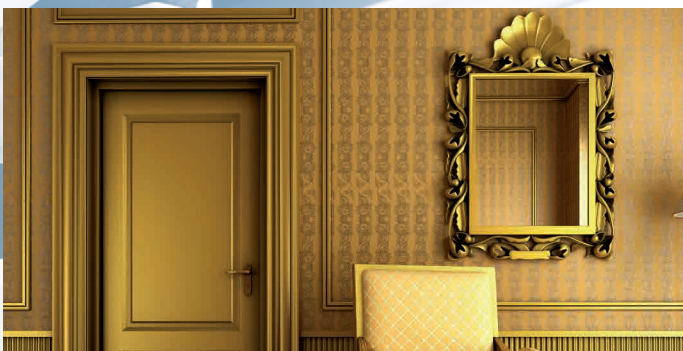



NUOVA  
BULLERI  
BREVETTI



Potenti applicazioni software CAD/CAM sono collegati a tutti i nostri controlli numerici. Potenti CAD facili da usare per gestire 3-4 e 5 assi in continuo. Software speciali sono realizzati per esigenze particolari.

Powerful CAD/CAM software applications are connected to all our numeric controls. Powerful CAD, easy to use for controlling 3-4 and 5 axes in a continuous manner. Special software designed for specific purposes.

Todos nuestros ordenadores están dotados de potentes aplicaciones software CAD/CAM. Potentes CAD fáciles de usar para controlar 3-4 y 5 ejes en continuo. Se realizan software especiales sobre exigencias clientes.





- CONTROLLI NUMERICI  
- NUMERICAL CONTROLS



Controllo numerico TECNOCOM con personal computer integrato sistema Windows.

Numeric control TECNOCOM with integrated PC, Windows system.

Control numérico TECNOCOM con ordenador personal con sistema Windows.

**Altri tipi a richiesta / Other types on the request**





NUOVA  
**BULLERI**  
**BREVETTI**



Ciascuna di queste macchine può essere offerta con dimensioni piani ed equipaggiamenti diversi a seconda delle esigenze produttive del cliente.

Each machine can be offered in different working top and equipment dimensions according to customer's needs.

Cada una de estas máquinas se ofrece también con dimensiones de mesas y equipajes diferentes según las necesidades productivas del cliente.

TC  
- LA GAMMA  
- THE RANGE



**BFPM**



**BFPM GANTRY**



**BFPM 6025**



**BFPM NESTING**



**BFPM 3616**



**FPM 3013 Door Line**



**BFPM 8026**



**BFPM PORTE**



**BFPM B**



**BFPM PORTE CONCEPT**



NUOVA  
**BULLERI  
BREVETTI**

INDUSTRIAL ART FOR CNC MACHINES  
ITALIAN MADE

**TECNOCOM** srl  
Via Calabria, 8 - Z.I. Gello  
56025 Pontedera (PI)  
Tel. (+39)0587.970190  
Fax (+39)0587.970191  
email: [info@tecnocomsrl.net](mailto:info@tecnocomsrl.net)

[www.nuovabulleri.com](http://www.nuovabulleri.com)

I dati contenuti nel presente catalogo non sono impegnativi e potranno subire variazioni senza preavviso.

Details specified in this catalogue are not binding and may be changed without notice.

Los datos contenidos en el presente catálogo son a título meramente ilustrativo y pueden sufrir variaciones sin comunicación previa.