



Glossy 650

Small size and high processing speeds



Easy Gloss

MACHINE DIMENSIONS (LxPxH) mm 3850x2350x1750

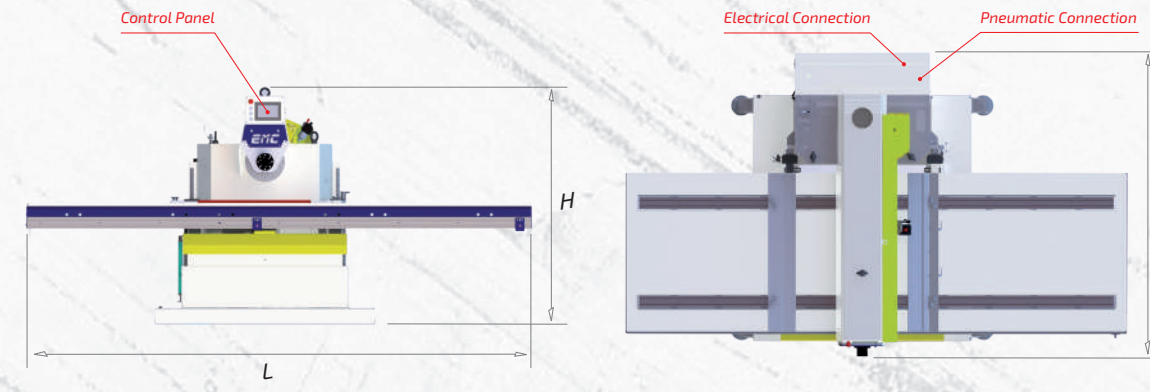

Glossy

MACHINE DIMENSIONS (LxPxH) mm 3000x1450x1600

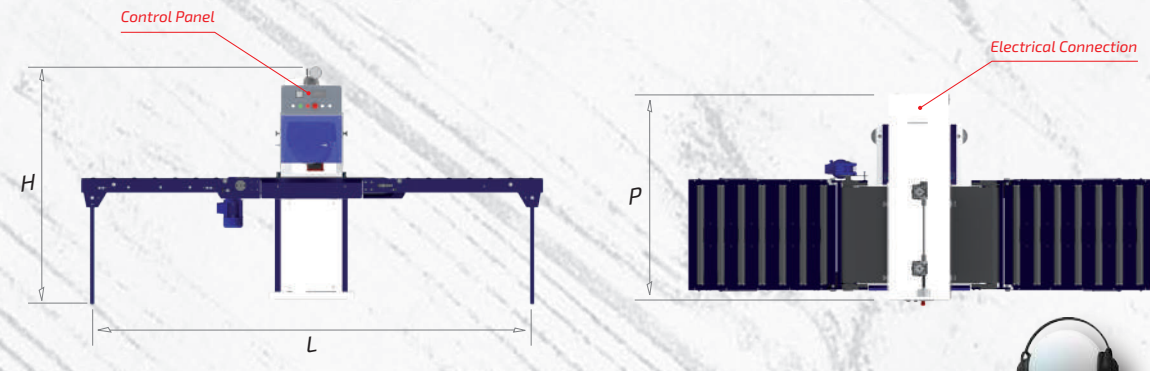

Need Help?

No problem. Just connect the electronic cable we gave you to the machine. EMC technician will do the rest of the job.

"Sanding is an Art, which comes from the Heart".
And we have a big Heart.



Via Brodolini, 23 - 40026 Imola (Bo) Italy
Tel. +39 0542 688034 - Fax +39 0542 643959
E-mail: info@emc-italia.it

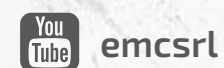
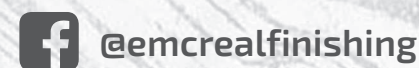

www.emc-italia.it



Easy Gloss 1250

When the pieces gets difficult
EMC give the solutions



Easy Gloss 1250

The highest quality finishing

- ▶ Flat
- ▶ Curved & Flat



Sistema di fissaggio di pannelli piani
Flat panel fixing system
Système de fixation de panneau plat



Sistema di fissaggio di pannelli curvi
Curved panel fixing system
Système de fixation de panneau incurvé

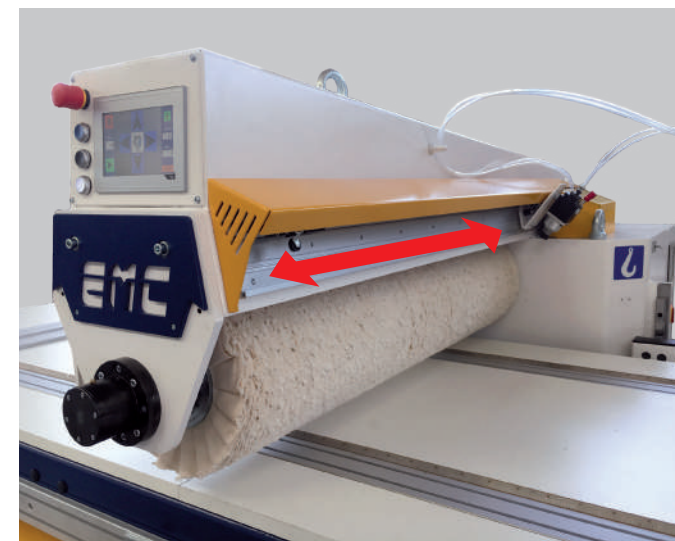

Sistema automatico di spruzzo della pasta
Automatic system for abrasive wax application
Système automatique pour application de la pâte abrasive



Sistema a depressione tramite pompa a vuoto
Vacuum system by vacuum pump
Système de vide par pompe à vide

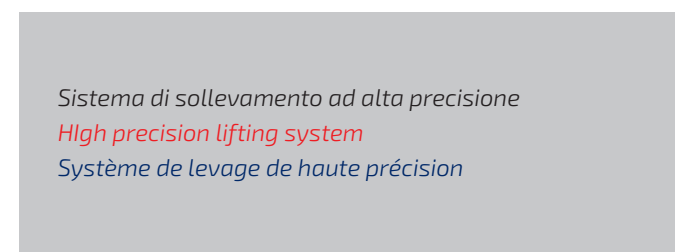

Sistema di sollevamento ad alta precisione
High precision lifting system
Système de levage de haute précision

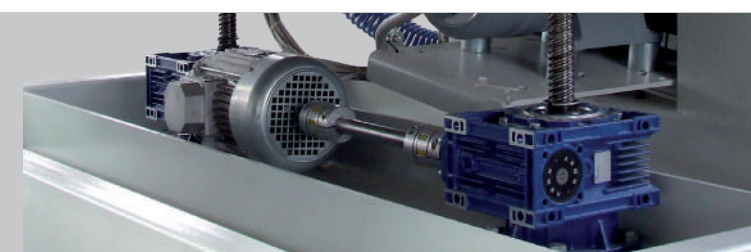

Glossy 650

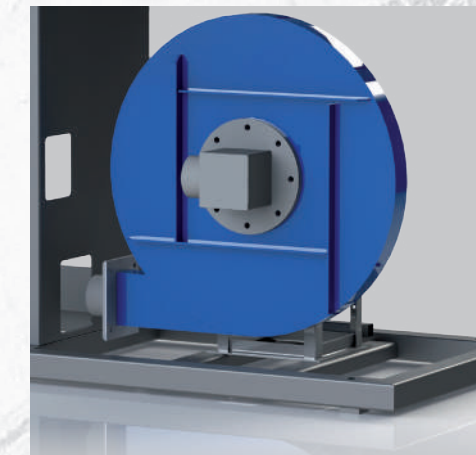

Depressore interno (taratura variabile, inverter)
Internal vacuum fan (setting variable, inverter)
Ventilateur dépression à l'intérieur (réglage variable, inverter)

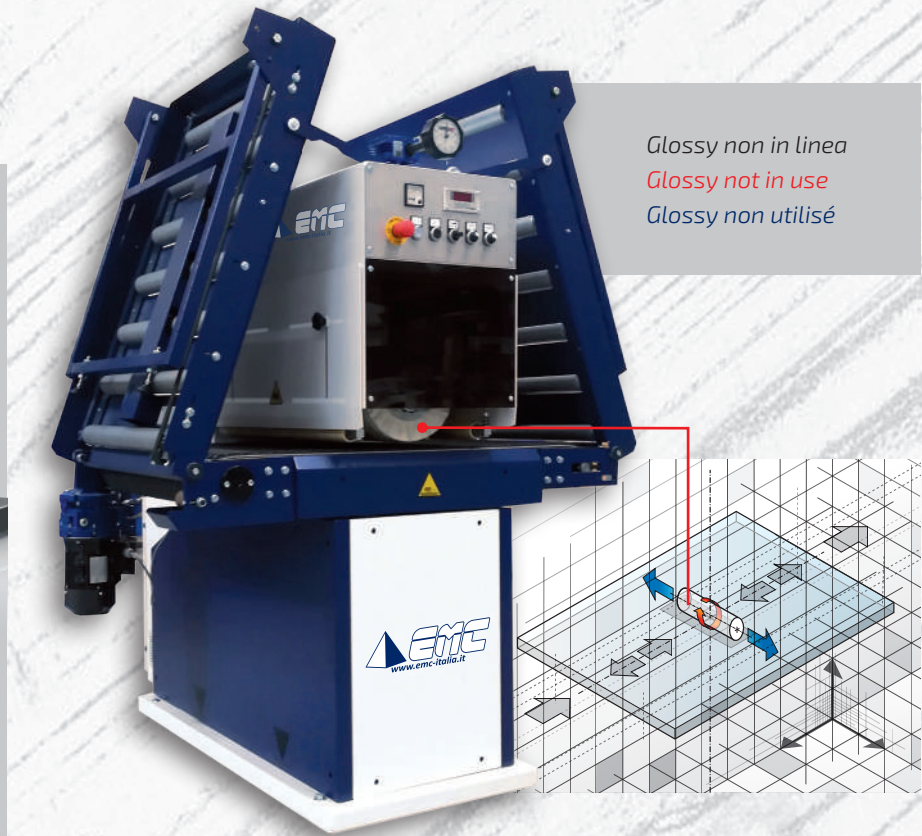

Glossy non in linea
Glossy not in use
Glossy non utilisé

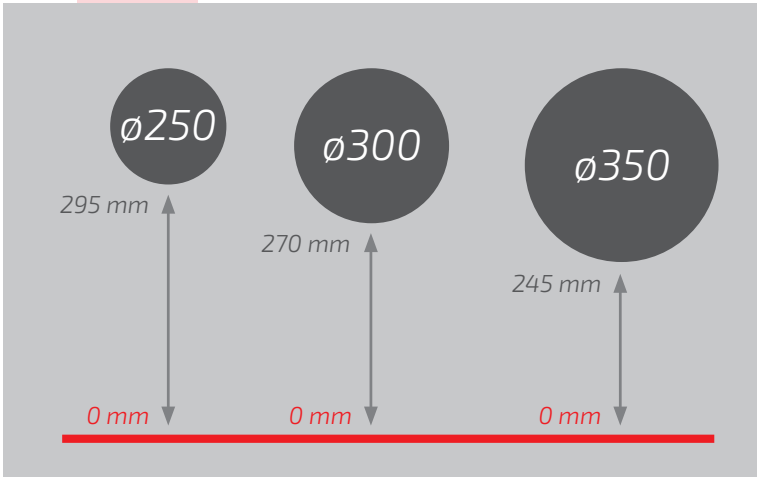

Spessore motorizzato regolabile
Automatic thickness adjustable
Épaisseur automatique réglable

Oscillazione spazzola integrata 30mm (15mm+15mm)
Integrated brush oscillation 30mm (15mm+15mm)
Oscillation de brosse intégrée 30mm (15mm + 15mm)

High gloss finishing up to 99%



Pannello di controllo con contatore programmabile di passate
Control panel with programmable passes counter
Panneau de contrôle avec compteur de passes programmable

