

**EXCITECH**<sup>®</sup>  
CNC TECHNOLOGY

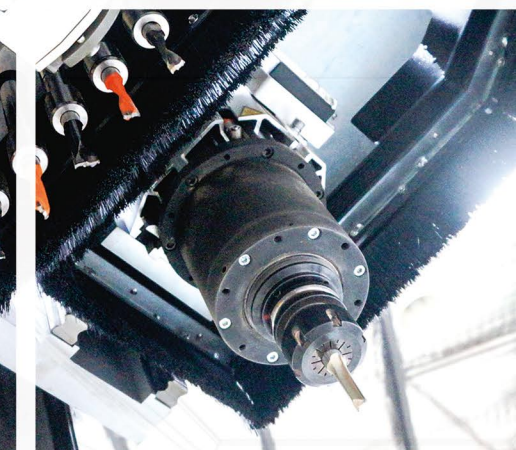

SMART FACTORY  
NESTING  
DRILLING  
PANEL SIZING  
EDGEBANDING  
5-AXIS  
CNC TECHNOLOGY  
and more...

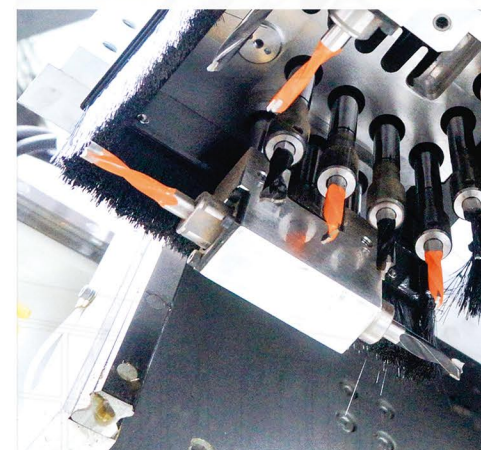
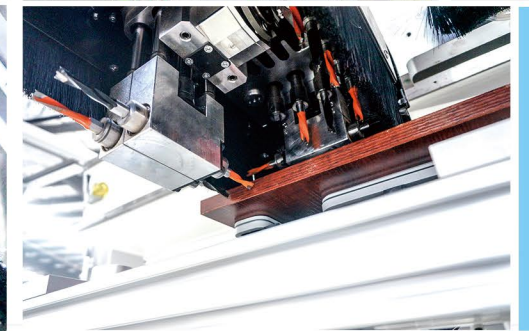

Scan QR-Code  
Follow Our Wechat Subscription

Authorized Agent

**Global Business Development**

Address: No.1832 GangYuanQi Road, Hi-Tech Industry Area  
Jinan, Shandong Province, P.R.China

Tel: +86-531-86569898 / +86-531-69983788

Fax: +86-531-86985868 / +86-531-69983188

Website: [www.excitechcnc.com](http://www.excitechcnc.com)

E-mail: [export@sh-cnc.com](mailto:export@sh-cnc.com) / [global@sh-cnc.com](mailto:global@sh-cnc.com)

VER9.8-08.2019 EN



# We Are **EXCITECH**®

## Quality Defines Us

### A Commitment to Excellence

Excitech, a professional machinery manufacturing company, was established with the most discriminating customers in mind. With manufacturing facilities in Shandong and Guangdong, China but strictly adhering with the highest quality standards, our products are guaranteed to perform with high precision at the longest period of time for your most demanding industrial requirements.

### State-of-the-Art Products and Facilities

Our wide variety of readily available high quality portfolio includes Fully Automatic Smart Factory, Panel Furniture Production Solutions, Multi-Sized 5-axis Machining Centers, Panel Saws, Point-to-Point Work Centers and other machineries dedicated to woodworking and other key applications.

Quality is never outsourced—that is why we have invested heavily in our own machining facility. All our products, from the most economical models to the most complicated ones are precision engineered to ensure the high standard expected from a company like Excitech. The whole manufacturing process is meticulously and systematically controlled to achieve the guaranteed precision and quality.

### Your Needs , Our Driving Force !

We also customize solutions according to your needs. Whether it is start-up businesses or small scale operations with cost efficient production in mind or established large scale operations looking for highly automated projects – Excitech always has solutions for your manufacturing needs. Our cutting edge technologies in machineries, softwares and central manufacturing control systems lead the markets in automating panel furniture production.

We are committed to making your business a success by providing customized solutions necessary in achieving your goals. The seamless integration of our machineries with industrial automation software and system enhances our partners' competitive advantages by helping them achieve:

- ◆ High quality products with the high production efficiency
- ◆ Lower costs thus measurable savings
- ◆ Shortened production time
- ◆ Maximized capacity for better profits
- ◆ Dramatically reduced cycle times

### Global Presence, Local Reach

Excitech has proven itself quality-wise by its successful presence in over 100 countries worldwide. Supported by a strong and resourceful sales and marketing network as well as technical support teams who are well trained and committed in providing our partners the best possible service , Excitech has gained a global reputation as one of the most reliable and trusted CNC machinery solution providers. Excitech provides 24hr factory support with a team of highly experienced engineers that serve customers and partners around the world, around the clock.

### Dedicated to Serve You

In Excitech, we are not just a manufacturing company. We are business consultants and business partners. Our technical expertise, our quality products, our state of the art manufacturing facilities, our strength in customer service, our competent sales consultancy, and our dedication to research and business development – all of these are presented to our business partners around the world in the hope of helping them to achieve success.

Quality,Service and Customer Centric while Creating Unending Value

—These are the Fundamentals of EXCITECH





# EXCITECH SMART FACTORY

We strive to make your production smarter,  
faster and more cost-efficient with minimum human labor required

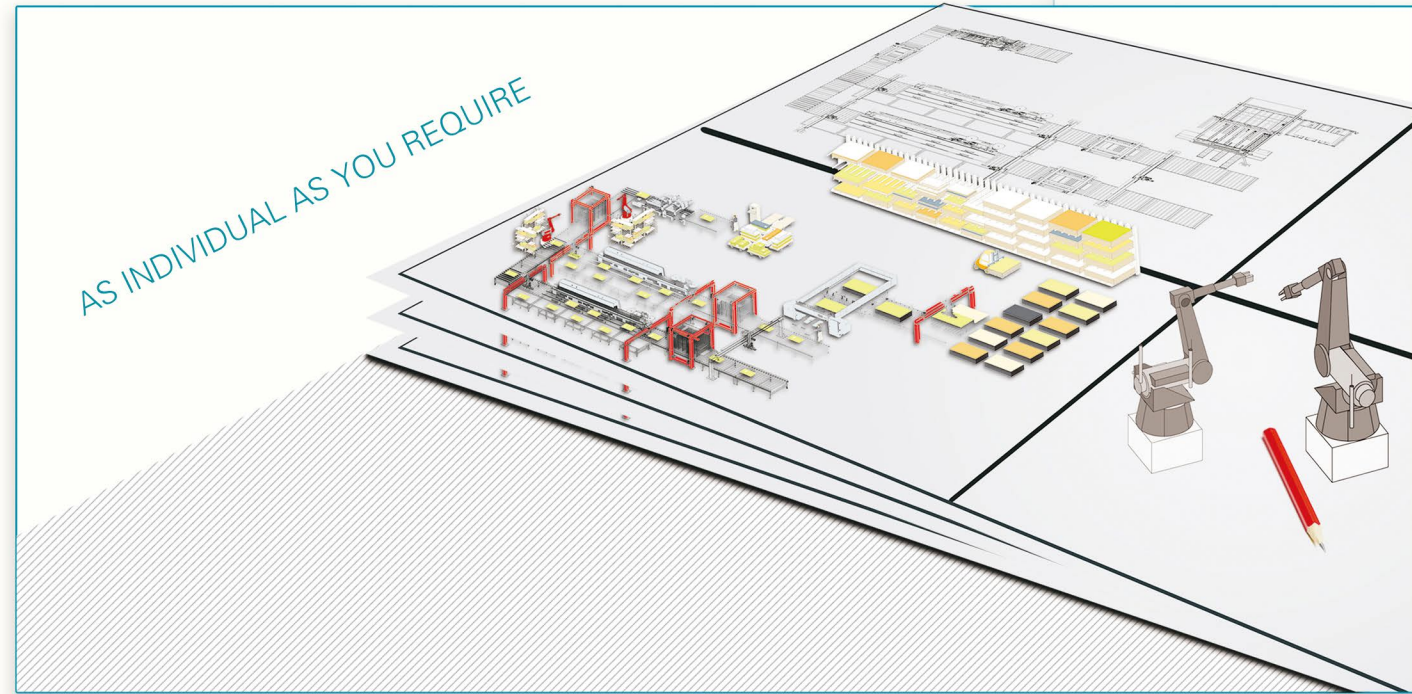

## Integration of Robotic Technologies



We understand different applications require different manufacturing equipments.  
Thus we personalize the projects so each investors can produce with the right technologies  
that match their exact needs.

### Contents

#### SMART FACTORY

Layouts.....	3
Cases .....	5
MES Production Management Software.....	9

#### SOLUTION FOR PANEL FURNITURE

Nesting .....	13
Panel Saw .....	21
Edgebanding .....	25
Drilling .....	31

#### AUTOMATIC CABINET DOOR SOLUTION

Precision Ball Screw Driven Machine...	39
Cabinet Door Production Line .....	40

#### FIVE-AXIS MACHINE CENTER

E10 Vantage Five-Axis Machining Center .....	41
E9 Venture Five-Axis Machining Center .....	43
E8 Mini Five-Axis Machining Center .....	45

#### WORK CENTER AND CNC ROUTER

Moveable Table Work Center .....	47
Heavy-Duty Work Center .....	49
Venture Work Center .....	50
MTC/ATC Product Range .....	51



# EXCITECH SMART FACTORY

## Automated Panel Furniture Production Line

We strive to make your production smarter,  
faster and more cost-efficient with minimum human labor required.

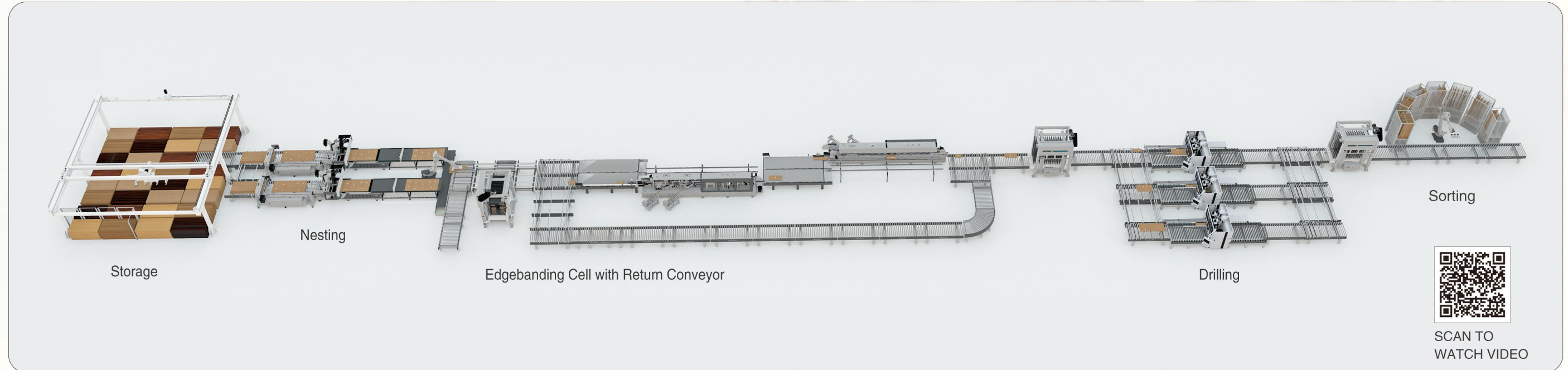

Nesting Cell and Buffer Unit



Edgebanding

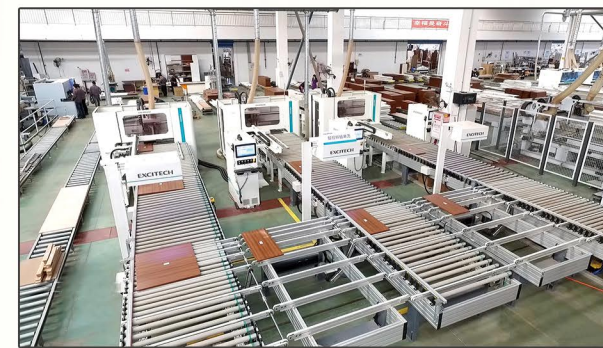

Drilling



Sorting

### ADVANTAGE

- ◆ The first project successfully implemented by Chinese machinery manufacturer.
- ◆ No operator required for production procedures. Labor costs and managing overheads are therefore greatly reduced, so is production error.
- ◆ Uninterrupted production with automatic machines enables furniture makers to add extra shifts with minimum extra costs and concerns. The efficiency is also increased by at least 25% compared to manual operation.
- ◆ Smarter, more cost-efficient production, quicker delivery and better quality allow furniture makers to further expand production and sales, achieving higher return on capital and property.
- ◆ More individualized products for end-users.





# EXCITECH SMART FACTORY

We strive to make your production smarter,  
faster and more cost-efficient with minimum human labor required.

## Application Examples:

A. One nested-based CNC, one drilling machine, with one edgebander

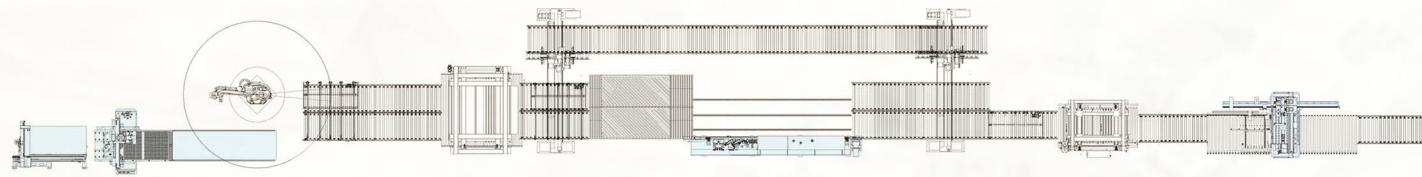

B. Two nested-based CNCs, three drilling machines, with two edgebanders

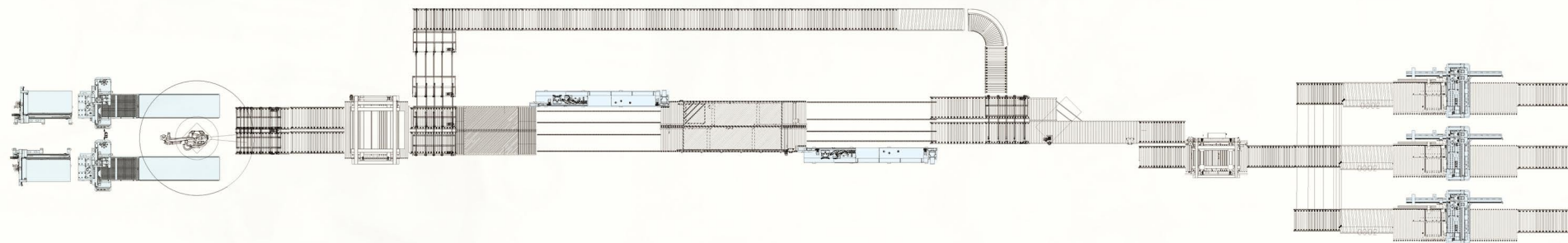

C. Fully automated production line with four edgebanders

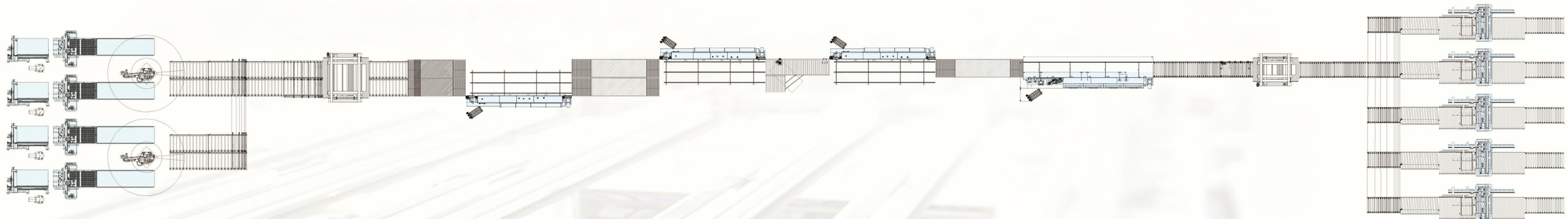

## Material Handling Devices:

(To be applied according to the factory layout and customer requirements)



Robot

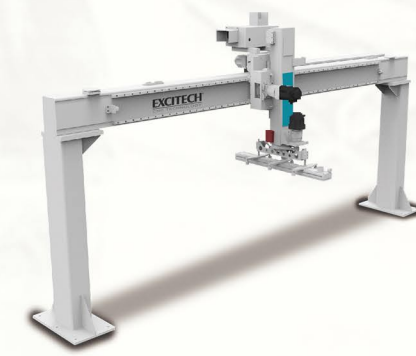

Gantry Structure Panel Transporter



Buffer Unit



Return Conveyor

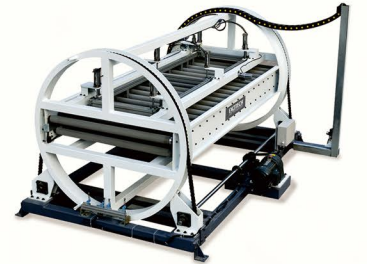

Barrel Turner





# EXCITECH SMART FACTORY

We strive to make your production smarter,  
faster and more cost-efficient with minimum human labor required.

Smart factory project can be sold as a whole  
or as separate production cells.

## Nesting Cell Scenarios

Barcode-Labeling, Panel-Nesting, Robot Unloading

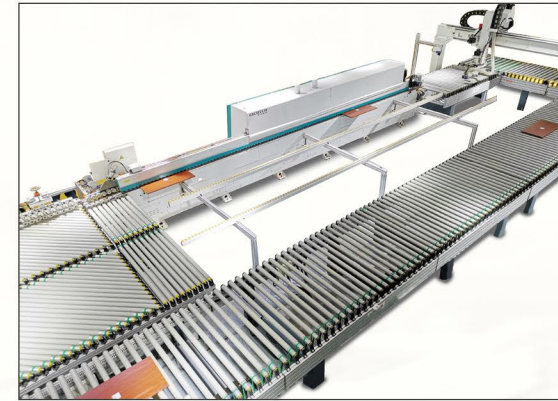
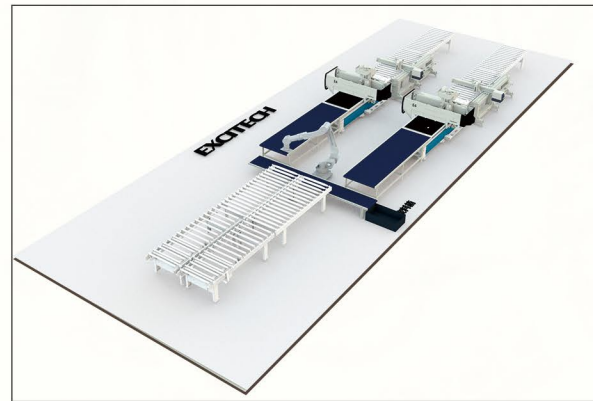
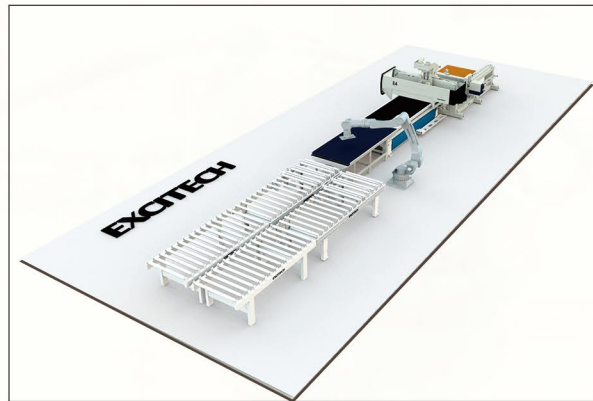

## Edgebanding Cell Scenarios

Edgebanding Cycle with Return System

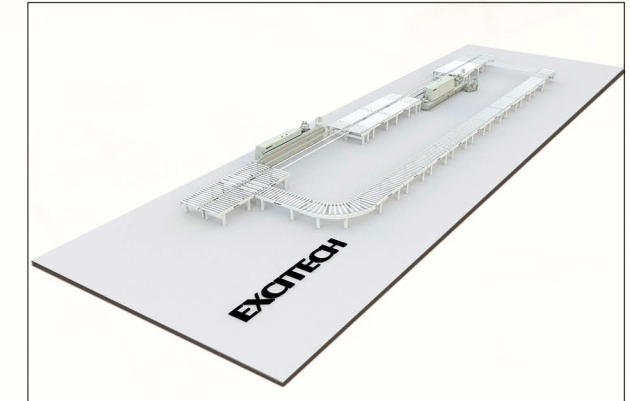
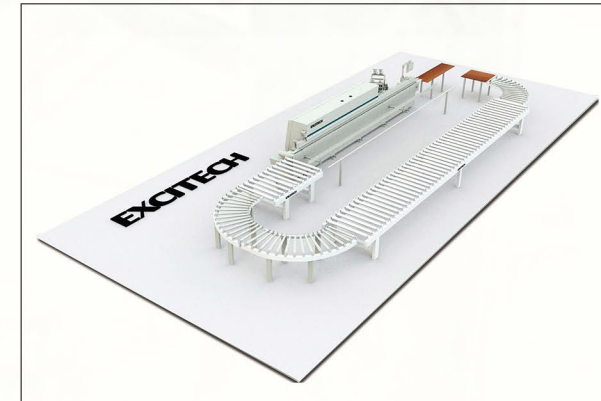

## Drilling Cell Scenarios

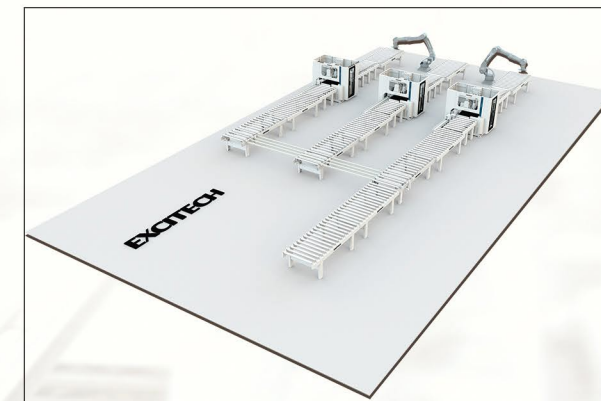
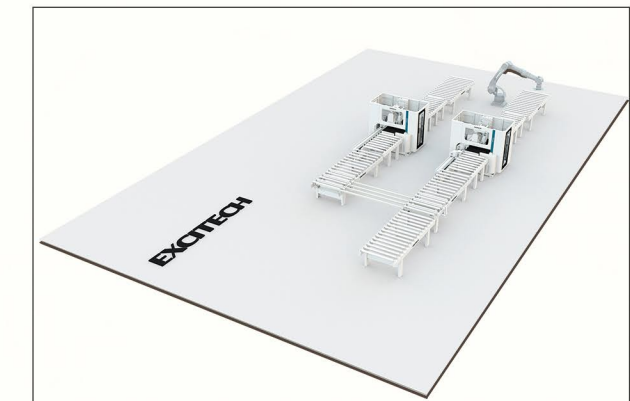



## EXCITECH E-SYSTEM — A Complete Solution from Design to Production

Our suite of softwares supports various businesses in individualized, intelligent and internet-based production.

### Design / Production / Data Management

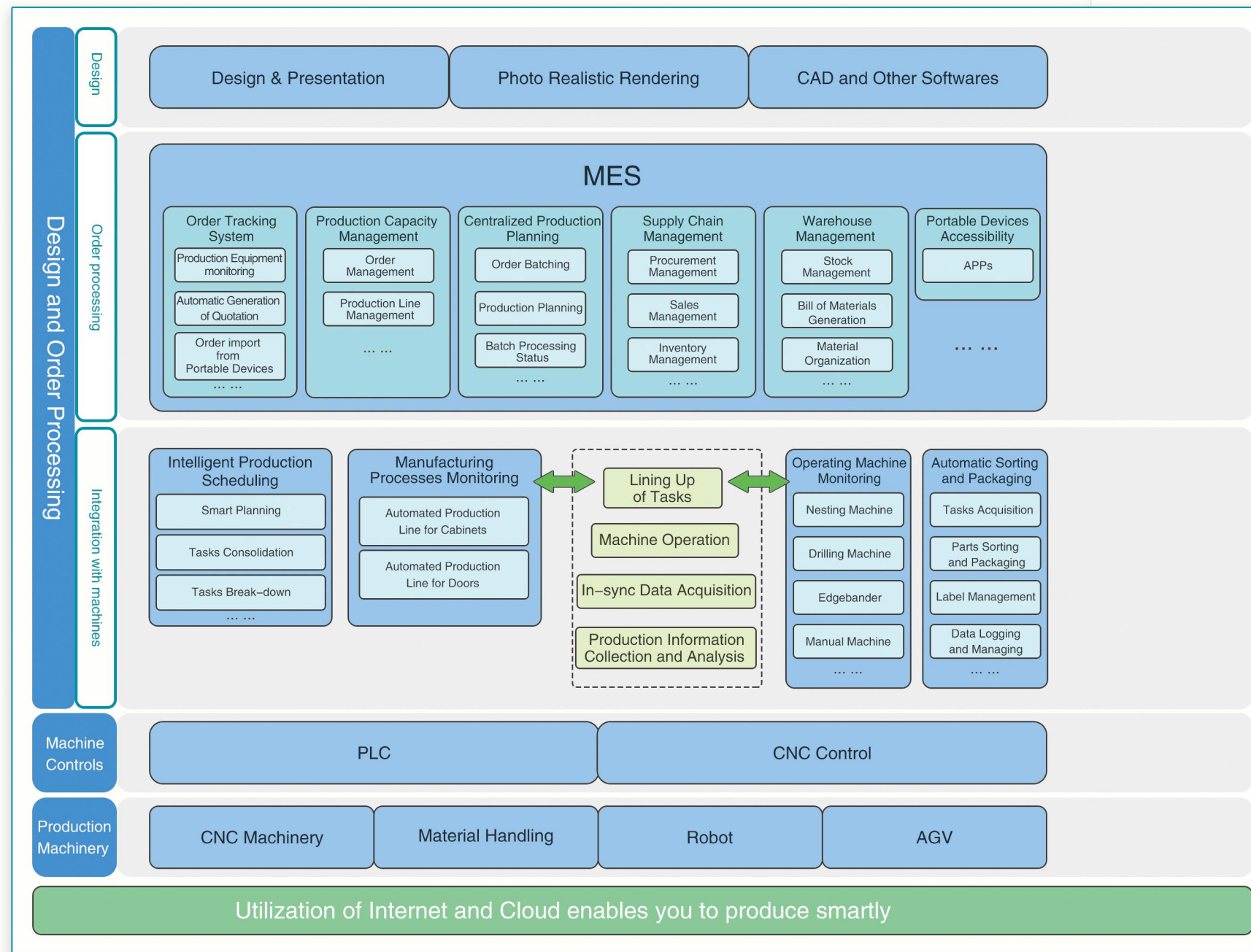

- Our softwares give your business a brain so it can produce and profit in a smart, efficient and cost-effective way
- Design to production in a few mouse clicks
- Softwares and the machines are perfectly integrated. The whole production processes are transparent and easily accessible.

2025  
Made in China

4.0  
INDUSTRY



# PANEL & WOODWORKING INTELLIGENT CNC MACHINERIES

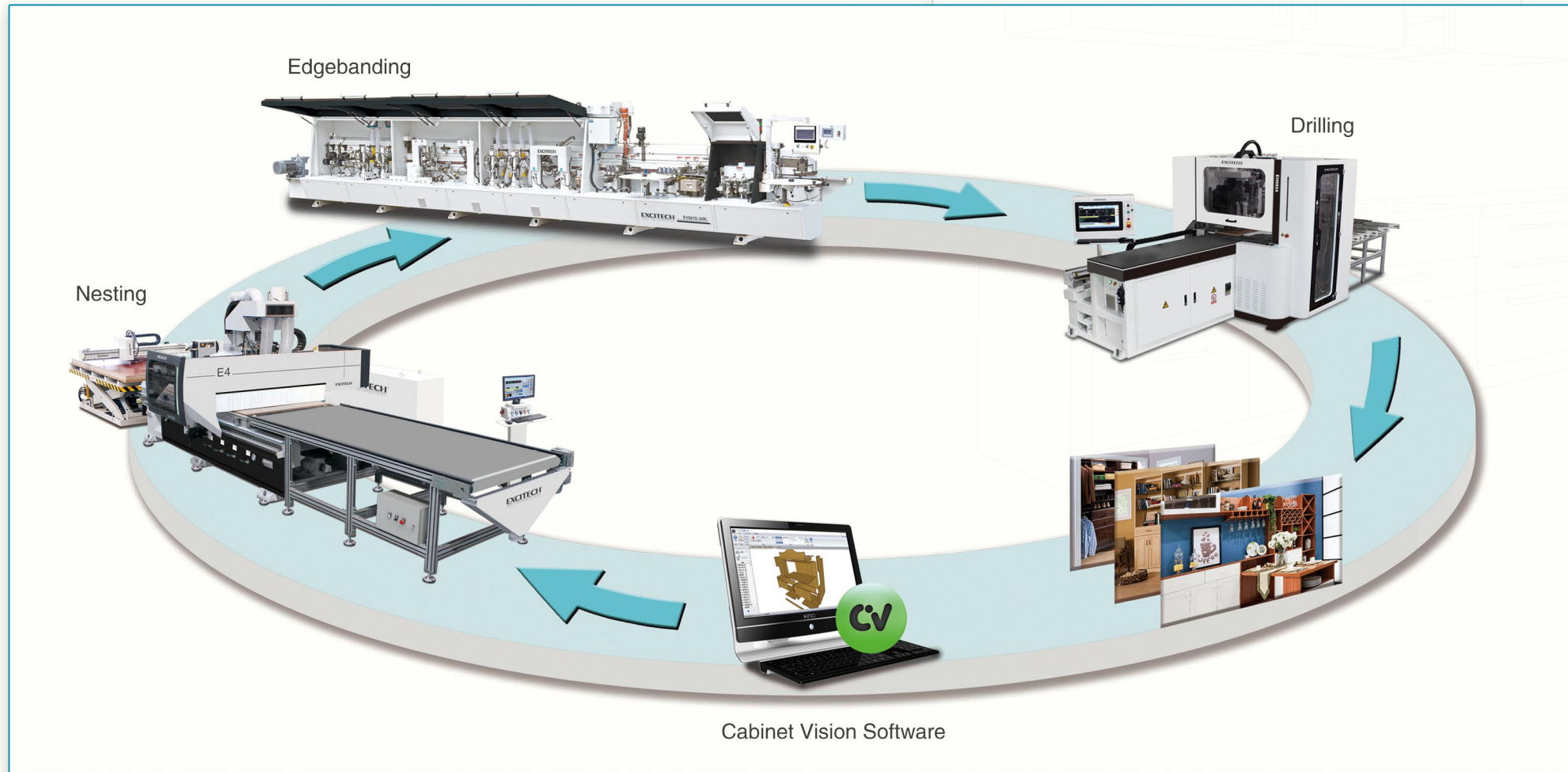

- E4 Nesting p13
- EV681G ( AIR ) Edgbanding p27
- EH0924 Drilling Machine p33
- Cabinet Vision Software

SMART CHOICE:

**EXCITECH**  
CNC TECHNOLOGY

- ◆ Different table sizes available to cater for different market needs
- ◆ Push-button operation and user-friendly interface
- ◆ Value-priced technology with world top brand components
- ◆ Precision engineering of frame and parts
- ◆ Supplied with Cabinet Vision ready-to-go
- ◆ Among the world's top producers numberwise--numerous successful installations is both cause and result



EPA270 Panel Saw p21



E2-9 Nesting Work Center p19



EV583 Edgbanding p29



EHSAW1224 Drilling Machine p31



# E4 NESTING (with automatic pre-labeling)

Automatic Pre-Labeling and In-Feed



Automatic Out-Feed

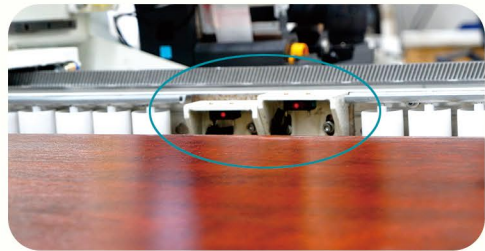

Two sensors—as opposed to commonly-seen one—double insure that panel stack is raised to the correct height and at the correct time



Pre-label the panel with rapid travel axis before nesting and vertical drilling further eliminates operator intervention during the work process and renders the whole cycle truly push-button-and-go.



Tool change stand that assists the operator to change tools quickly and easily

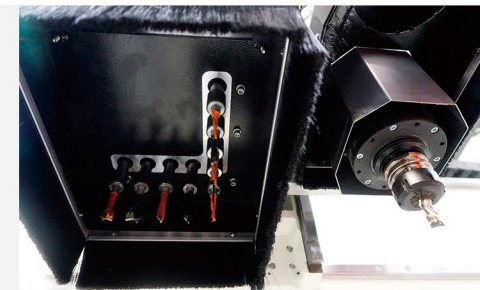

HSD Spindle: 9.6kW  
(Higher power available upon request)  
Italian drill bank: 5+4 vertical drills



Carousel Tool Changer  
8 tools or more upon request.  
Servo drives for faster and more accurate motion available



Italian OSAI control  
Control unit separate from the main electrical cabinet that promises better mobility and safety.

### Features

- ◆ Top of its range, this solution has the great advantage of not requiring the constant presence of an operator. The suction cups equipped on the gantry travels to the rear of the machine to pick up the workpiece from the scissor lift, which is then nested and drilled at the flat table. At the completion of the work cycle, the pusher transports the completed workpiece out of the working area allowing simultaneous loading of the next cycle.
- ◆ Features world's top class components. The enclosure over the gantry with LED light strip for display of the machine status prevents flying out of materials and greatly enhances safety.
- ◆ Truly versatile—nesting, routing, vertical drilling and engraving all in one. It is well-suited for panel furniture, office furniture, kitchen, cabinets production.



SCAN TO  
WATCH VIDEO



# E4 NESTING

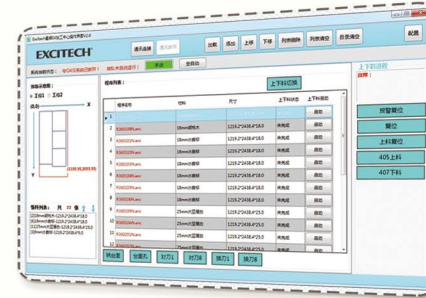

## Q-UP DATA MANAGER

lines up the tasks for the day job. Operator needs only push start button once and the system will automatically carry out the rest of the tasks in the line. Available on all nesting machines.

## JOIN HANDS WITH OUR WORLD-RENOWNED PARTNERS

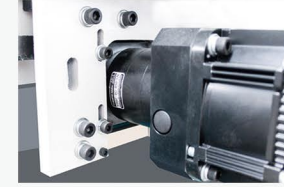

Japanese Shimpo Planetary Gear Box



Japanese THK Linear Guide Rails



German Becker Vacuum Pump



Japanese SMC Air Cylinder

## E4 Upholstery Furniture Production Double Work Zone Model

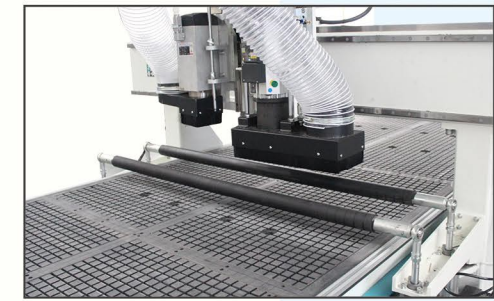

Sensor at the end of the unloading table detects if the workpieces have been transported to this area for easy reach. It also makes sure that the workpieces are not transported beyond this point so as not to fall off the table.



Available as stand-alone work center or with in-feed or out-feed to form an automated nesting line.



SCAN TO  
WATCH VIDEO



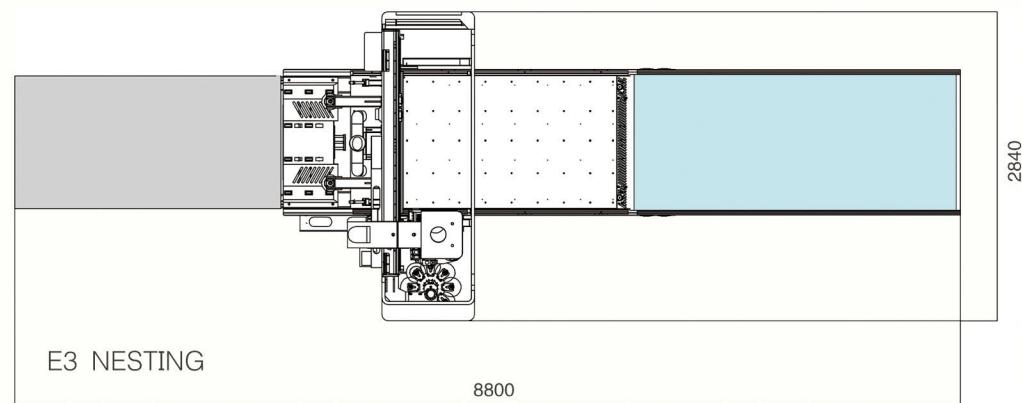
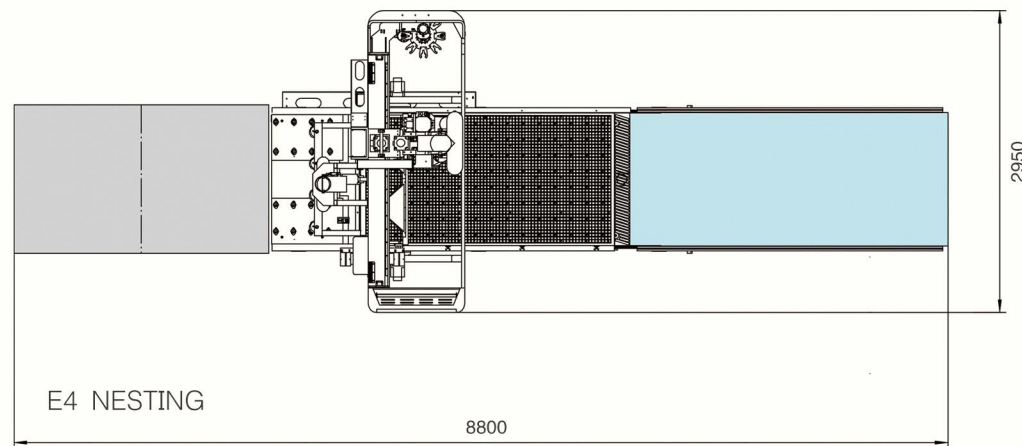
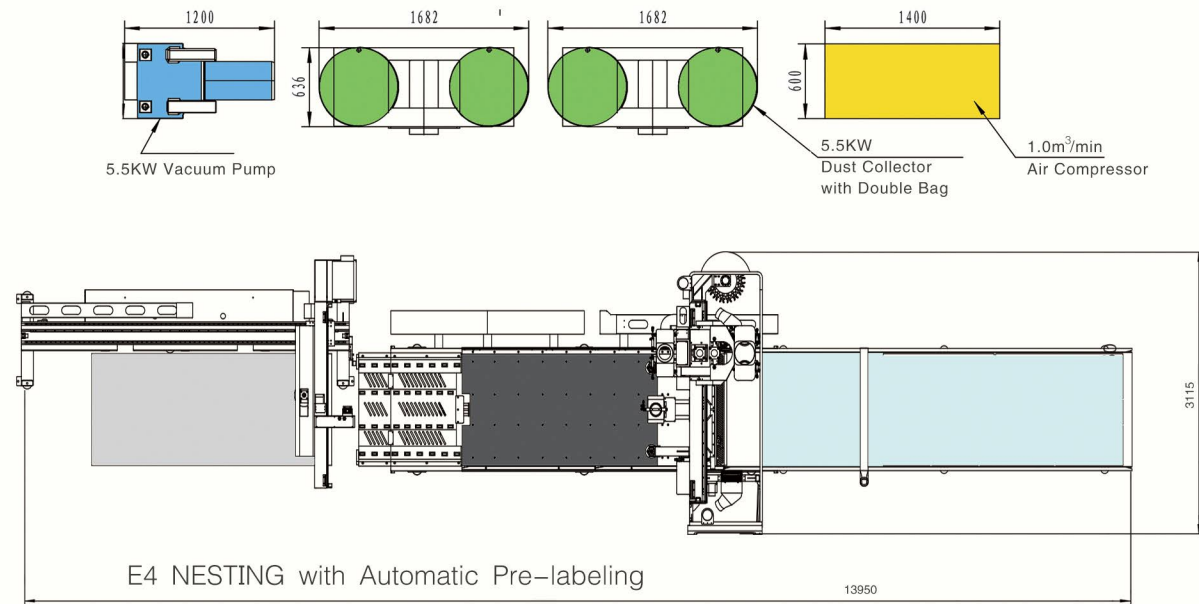

E4 Nested Based Production Flow

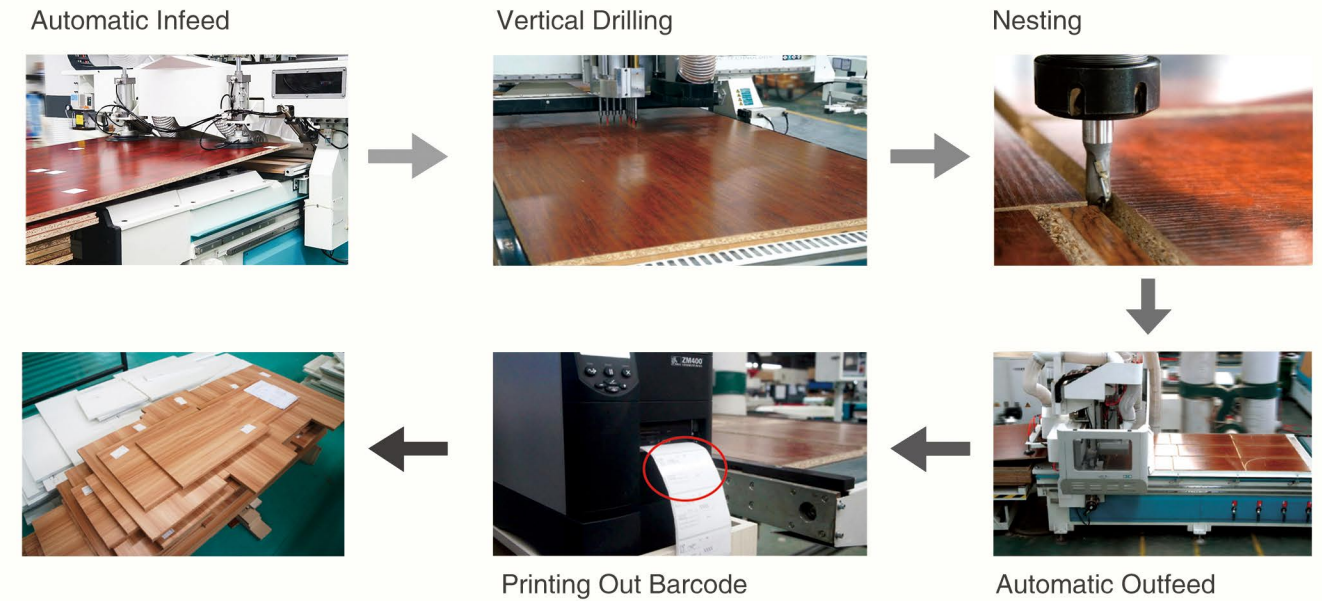

SERIES	E4-1224D	E4-1230D	E4-1530D	E4-1537D	E4-2128D	E4-2138D
Traveling Size	2500x1260x200mm	3140x1260x200mm	3140x1600x200mm	3700x1600x200mm	2900x2160x200mm	3860x2170x200mm
Working Size	2440x1220x70mm	3080x1220x70mm	3074x1550x70mm	3685x1550x70mm	2850x2130x70mm	3800x2130x70mm
Table Size	2440x1220mm	3080x1220mm	3074x1550mm	3685x1550mm	2850x2130mm	3800x2130mm
Loading and Unloading Speed	15m/min					
Transmission	X/Y rack and pinion drive, Z ball screw drive					
Table Structure	Vacuum Table					
Spindle Power	9.6 / 12kW					
Spindle Speed	24000r/min					
Traveling Speed	80m/min					
Working Speed	25m/min					
Tool Magazine	Carousel					
Tool Slots	8/12					
Driving System	Yaskawa					
Voltage	AC380/3PH/50Hz					
Controller	OSAI / Syntec					

★ ALL DIMENSIONS SUBJECT TO CHANGE



## E2-9 NESTING WORK CENTER



E2-9



E2-9 with Infeed and Outfeed

Introducing our budget nesting solution, still using the top notch components. Available as stand-alone machine, double table for double output or with automation.

Having a budget but do not want to get by? Try our **E2-9 Nesting** that comes with a pusher-blower that pushes off the finished workpiece while simultaneously blows off the dust. It is truly a 'have-it-all' that takes up only limited space. If you have extra space available, you could opt for our E2-9 with double work tables or simply add the infeed and outfeed modules to give a boost to your production efficiency.

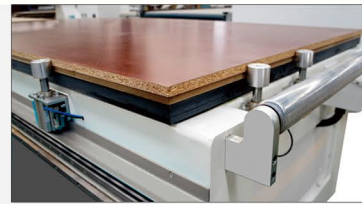

Pop-up pins for accurate positioning of workpiece



Two spindles, one for nesting, one for grooving, or have it your way—the two manual tool changing spindles work together and eliminates half the tool-changing time. 5+4 Vertical Drill Bank is standard feature.



E2-9 Double Work Table



Rollers located at the front and rear end of the machine for easier loading and off-loading.



SCAN TO  
WATCH VIDEO



## EPA270/330/380 PANEL SAW



Panels are optimized in batches—guaranteed utilization of up to 95%



We believe a sturdy construction is the foundation of good cut quality, which is why we insist on using the heavy frame to ensure the precision and finish.



Moveable tables allow the operator to freely move all sizes of panels with ease.

## EP330H REAR-FEEDING PANEL SAW



### Features

- ◆ Precision helical rack and pinion drives ensure smooth and dynamic running even at the highest speeds, at the same time reducing noise to the minimum.
- ◆ Main saw motor is linked to the saws by V-ribbed belt that results in the clean precision cut.
- ◆ Cutting is automatically adjusted to the size of the panels according to the value set—dramatically reduces the cycle time.
- ◆ Saw blades are easy to be loaded and unloaded in an efficient manner.
- ◆ The main saw and the scoring saw with electronic lift feed on linear guide that obtains lasting straight-line precision and rigidity and guarantees excellent cutting finish.

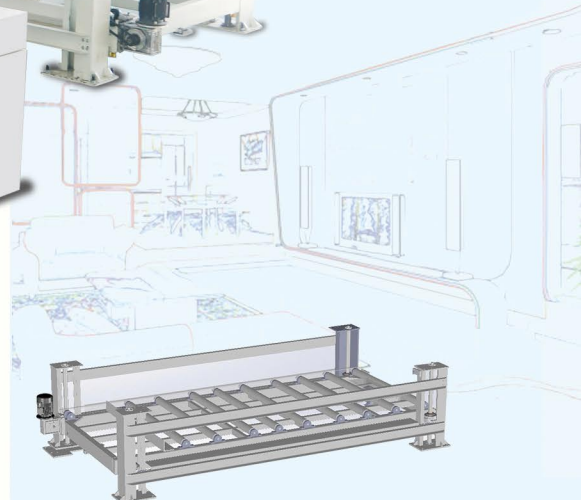

- ◆ The rear lifting table is constructed in a way to sustain heavy load while maintain a steady raise.
- ◆ There are sensors to detect stack height and automatically adjust the lifting table.
- ◆ Panels are fed from the side to maximize floor space.



The clamps wrapped with rubber hold the material firmly and gently. Contact pressure adjustable to accommodate different material and deliver invariably perfect cut quality.



Air table reduces the friction to the minimum to prevent chipping and wearing of the materials.



The precise and powerful movement of the servo driven saw carriage, along with the 15kW main saw motor guarantee a clean finish even when cutting multiple panels.



Quick Change-Over of Saw Blade

### EP330H Rear-Feeding Panel Saw

Panel saw with rear feeding system greatly reduces cycle time, resulting in higher efficiency as well as output. The fully automatic lifting system and infeed clamps work together to eliminate the need for operator intervention.

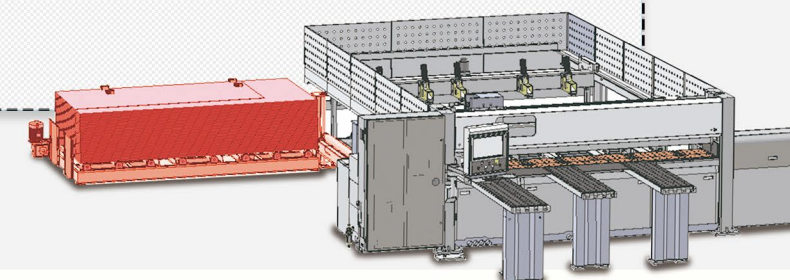

SCAN TO WATCH VIDEO



SERIES	1224	1230	2128
Traveling Size	2500x1260x200mm	3050x1260x200mm	2900x2160x200mm
Working Size	2440x1220x50mm	3000x1220x50mm	2850x2130x50mm
Table Size	2440x1228mm	3000x1228mm	2850x2130mm
Unloading Speed	15m/min		
Transmission	X/Y rack and pinion drive, Z ball screw drive		
Table Structure	Vacuum Table		
Spindle Power	6.0kW / 5.5kW		
Spindle Speed	18000r/min		
Traveling Speed	40m/min		
Working Speed	18m/min		
Driving System	Yaskawa		
Voltage	AC380/3PH/50Hz		
Controller	Syntec		

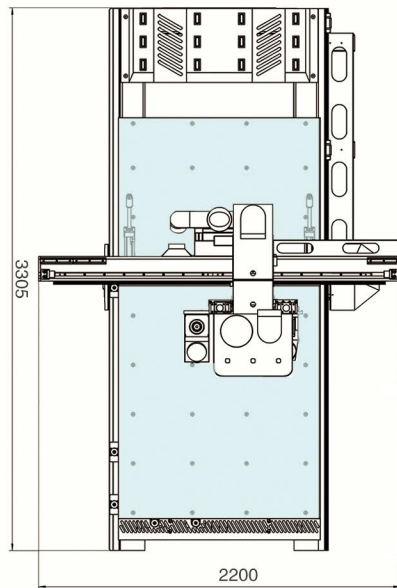

E2-9 NESTING

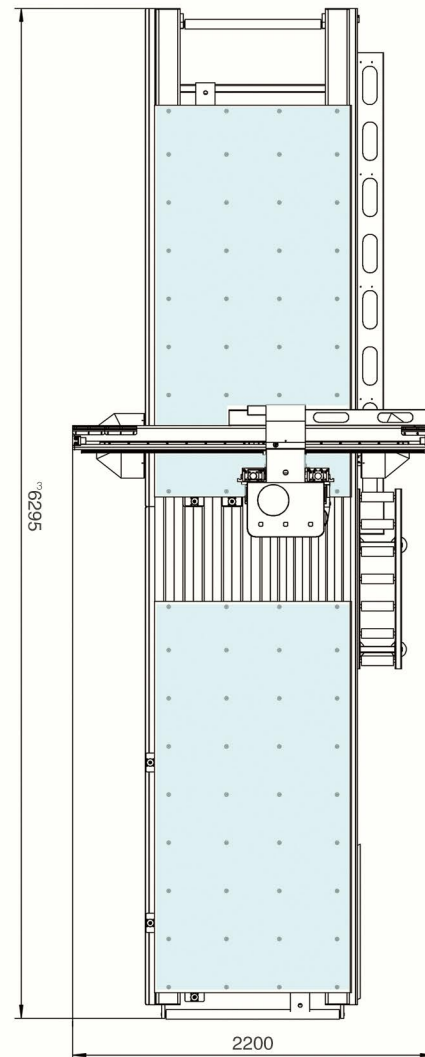

E2-9 NESTING ( DOUBLE WORK TABLE )

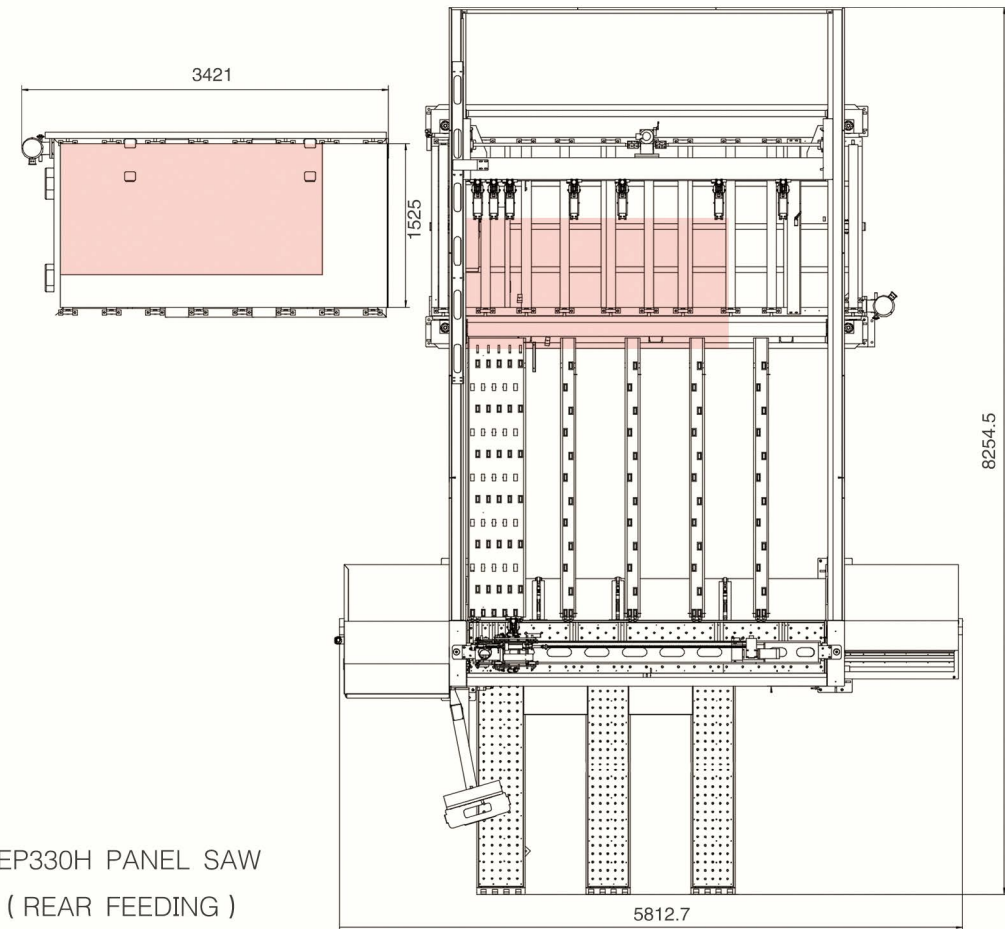

EP330H PANEL SAW  
( REAR FEEDING )

SERIES	EP330 ( Rear Feeding )	EPA270	EPA330	EPA380
Cuting Dimension	3300x3300x80mm	2700x2700x80/120mm	3300x3300x80/120mm	3800x3800x80/120mm
Saw Carriage Speed	5-80m/min	5-80m/min		
Main Saw Motor	15kW	15/18.5 kW		
Scoring Saw Motor	2.2kW	2.2kW		
Main Saw Dimension	380x4.4x60mm	380x4.4x60mm / 450x4.8x60mm		
Scoring Saw Dimension	180x4.4-5.4x45mm	180x4.4-5.4x45mm		
Air Consumption	150L/min	150L/min		
Loading Speed	13m/min			
Max Feed Size	3050x1550mm			
Max Stack Height	630 / 1200mm			



# EDGEBANDING TECHNOLOGY

EV781G / EV780G

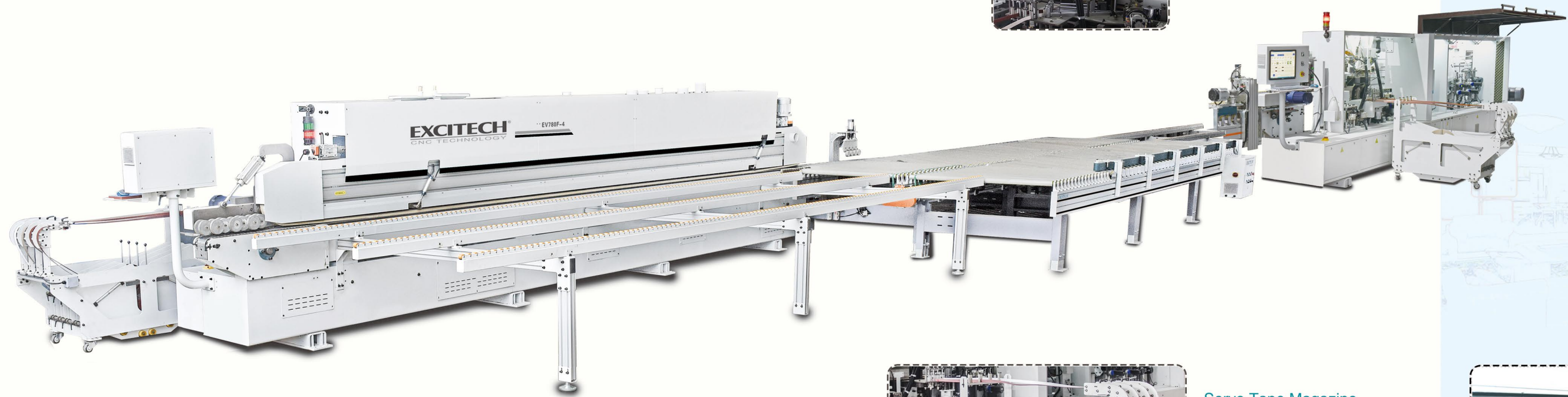

★ ALL DIMENSIONS SUBJECT TO CHANGE

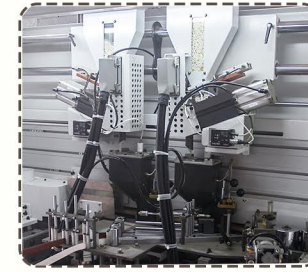

Top pre-melter reduces heating time and increases the quality of edge banding.

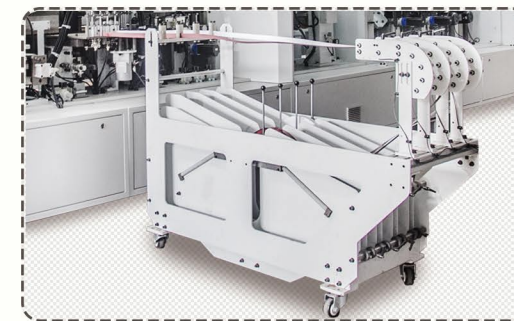

### Servo Tape Magazine

Four wheel tape magazine automatically changes edge with servo motor. The process is both accurate and swift.



Double V-belt Top Pressure System

### Edgebander Cell Scenarios

Double side infeed edgebander with return conveyors:

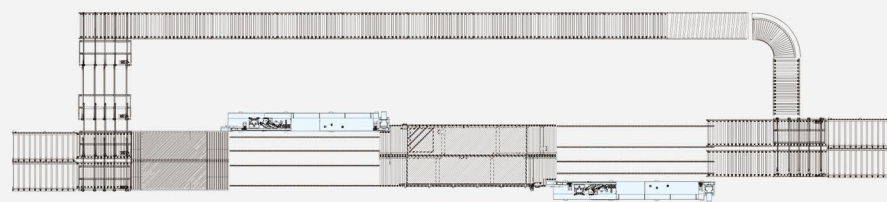

Four edgebanders forming a line



Application Example:

Edgebander with Return Conveyors



### 6 Roller Pressure Zone

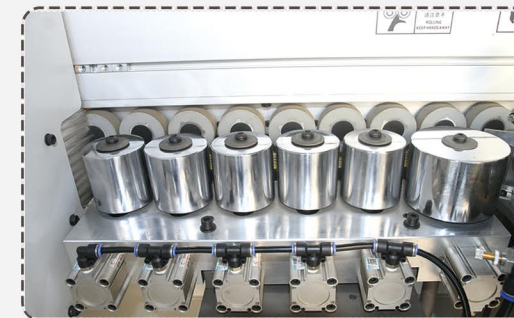

- ◆ One big precision roller and 5 small to make sure the edge is pressed seamlessly to the workpiece.
- ◆ The big roller and gluing rollers press simultaneously. The 5 small rollers consist of 1 cylinder shaped and 4 cone shaped rollers. The latter further ensures that the edge is properly pressed to the workpiece.
- ◆ All rollers have their independent pressure control valve.



# HIGH SPEED EDGEBANDING TECHNOLOGY

## EV681G ( AIR ) Hot-Air Edgebanding Machine

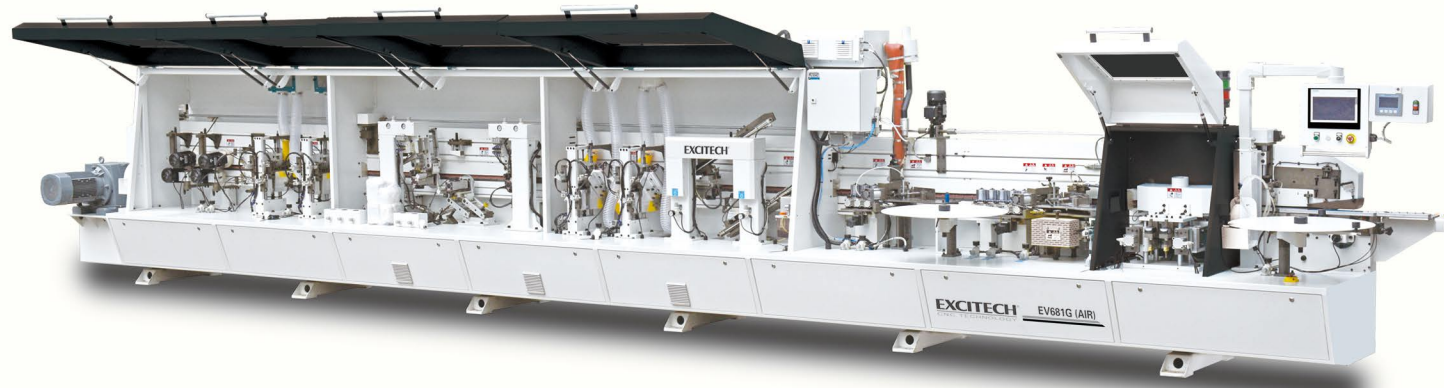

## EV681G Dual Gluing Units Edgebanding Machine

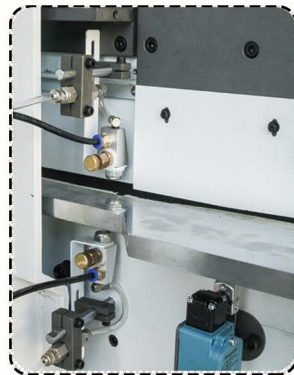

### Spraying Unit

This device spray-applies a thin coat of release agent to the upper and lower edge area of the workpiece and prevents squeezed out glue from adhering to the workpiece.

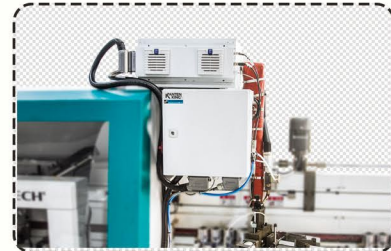

### Hot Air Edgebanding Technology

Available Upon Request

Zero glue line, Minimum heating time required, water-resistant, saving the trouble of cleaning the glue pots.

To be used with edges with PVC, ABS, PP, PMMA or melamine coating.

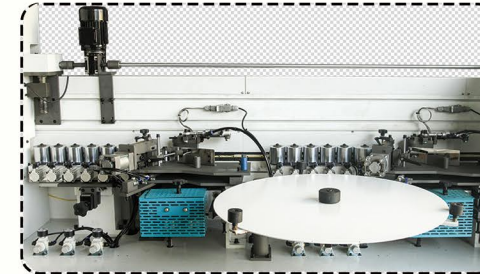

### Double Glue Reservoirs

Available Upon Request

Two glue reservoirs to quickly switch between colors and to achieve invisible joint.

### Features

- ◆ The gluing unit features quick melt and an application device that guarantees perfect glue quality on different edge materials.
- ◆ Temperature adjustable by control. When the edgebander is running without workpiece, the system automatically stops heating up the glue.
- ◆ The trimmed edge is always finished with a clean cut thanks to the precision linear guide and the high speed motors.
- ◆ Quick changeover between different edges can be easily realized by clicking on the touchscreen.
- ◆ 4 motors that travel in a reciprocating motion to clean and buff the workpiece.

### EV681G Air Features

EV681G AIR	Spray Release Agent	Pre-Milling	Gluing Hot Air	End Trimming	Rough Trimming	Fine Trimming	Corner Trimming	Scraping	Flat Scraping	Spray Cleaning Agent	Buffing (Air Cylinder Controlled)
------------	---------------------	-------------	----------------	--------------	----------------	---------------	-----------------	----------	---------------	----------------------	-----------------------------------



Flat Scraping



R Scraping



Trimming

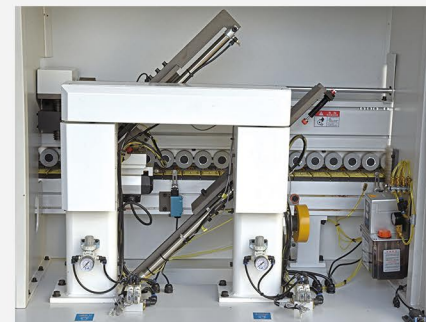

Two motors traveling on linear guides for end-trimming

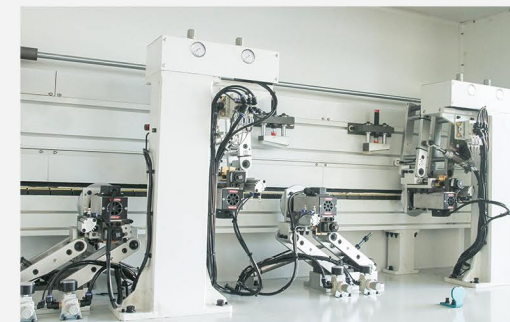

### Corner Trimming Unit

With 4 motors, this device works well with various edge thicknesses and invariably result in perfect round corner.



SCAN TO WATCH VIDEO



# EDGE BANDING TECHNOLOGY

## EV583



### Pre-milling Unit

- ◆ Equipped with diamond tools for better cut and longer use.
- ◆ This device removes the burr or unevenness on the edge of the workpiece, leaving a smooth surface for the edgebanding.
- ◆ Profiling units available upon request.



SCAN TO  
WATCH VIDEO

## EV583GX ( Straight and Slanted Edge )

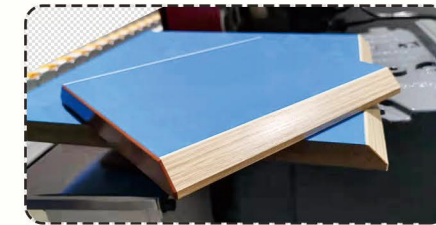
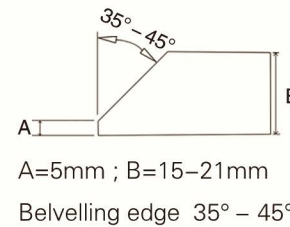

## EV581W ( Narrow Panel Edgebanding )

Especially suitable for small narrow panel 30mm



SERIES	Spray Release Agent	Pre Milling	Gluing	Infrared Heating	Rough Trimming	Fine Trimming	Corner Trimming	Scraping 1	Scraping 2	Off-cut	Flat Scraping	Spray Cleaning Agent	Buffing
EV781G	•	•	Top Pre-melter x2	••	•	•	•	•		•	•	•	••
EV780G	•	•	Top Pre-melter x2	••	•	•		•		•	•	•	••
EV681	•	•	Quick-melter	•	•	••	•	•	•	•	•	•	••
EV680	•	•	Quick-melter	•	•	••		•	•	•	•	•	••
EV583		•	•		•	•	•	•		•	•		•
EV583GX	•	•	•	•	•	•	•	•			•	•	•
EV582			•		•	•	•	•		•	•		•
EV581		•	•		•	•		•		•	•		•
EV580			•		•	•		•		•	•		•

SERIES	Machine Dimensions (LxWxH)	Power	Feed Speed	Panel Thickness	Minimum Workpiece Dimensions	Edge Thickness	Workpiece Thickness	Workpiece Length	Workpiece Width
EV781G	11485x2700x1800	34.5kW	22~28m/min	10 ~ 60mm	300mmx300mm	0.4~3mm	12~65mm	Min.150mm	Min.60mm
EV780G	9360x2700x1800	31kW	22~28m/min	10 ~ 60mm					
EV681	10570x2670x1770	27kW	20 ~ 26m/min	10 ~ 60mm	300mmx80mm or 150mmx150mm				
EV680	8520x2670x1770	25.6kW	20 ~ 26m/min	10 ~ 60mm					
EV583	7640x950x1655	16.6kW	16 ~ 23m/min	10 ~ 60mm					
EV583GX	9580x1800x1655	36.3kW	16 ~ 23m/min	10 ~ 60mm	300mmx80mm or 150mmx150mm				
EV582	6745x950x1655	12.6kW	16 ~ 23m/min	10 ~ 60mm					
EV581	6400x950x1655	14.3kW	16 ~ 23m/min	10 ~ 60mm					
EV580	5500x950x1655	10.3kW	16 ~ 23m/min	10 ~ 60mm					

★ All DIMENSIONS SUBJECT TO CHANGE



## EHSAW 1224

### Throughfeed 6-Sided Drilling Machine (Single / Dual drill banks Optional)

#### Drill Bank

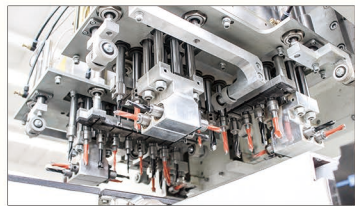

3.5kW Spindle (\*2)  
33 Vertical  
+ 16 Horizontal



Automatic in-feed device available upon request.

#### Features

- ◆ Throughfeed 6-sided drilling machine that completes drilling on all 6 sides in one cycle.
- ◆ Two drill blocks work simultaneously to drill vertical and horizontal holes.
- ◆ Equipped with 2 drill banks for more diversified applications.
- ◆ Double grippers that adjust distance according to the panel dimension. Ability to process board as small as 50mm.

Max Workpiece Dimensions:  
2440 × 1200 × 50mm

Min Workpiece Dimensions:  
200 × 50 × 10mm

SCAN TO  
WATCH VIDEO



Equipped with 2 drill banks for more diversified applications.

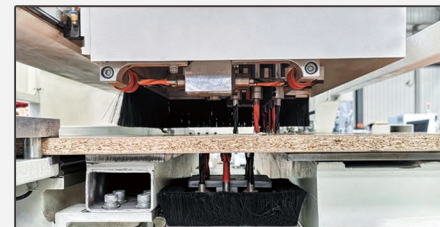

6-sided drilling completed in one cycle

#### Multiple units to form a line:

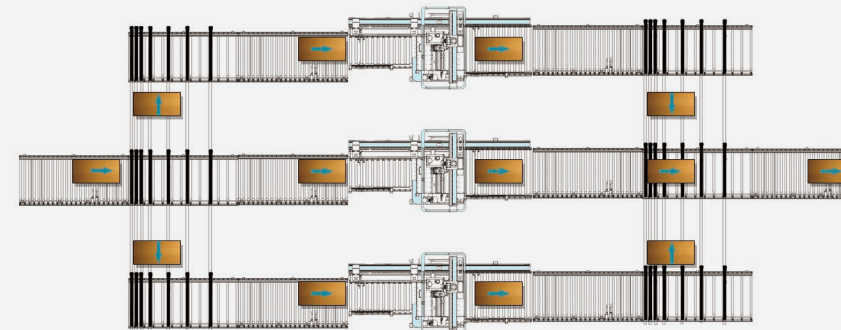



# EH0924/1224 DRILLING MACHINE (FIVE-SIDED / SIX-SIDED)

## Features

- ◆ Five-sided drilling machine with bridge structure processes five sides in a single cycle
- ◆ Double adjustable grippers hold the workpieces firmly despite their length
- ◆ Air table reduces friction and protects the delicate surface
- ◆ The head is configured with vertical drill bits, horizontal drill bits, saws and spindle so the machine could perform multiple jobs

Five-Sided:  
3.5kW Spindle  
12 Vertical  
+ 8 horizontal

Six-Sided:  
3.5kW Spindle (\*2)  
21 Vertical  
+ 8 horizontal

Max Workpiece Dimensions:  
2440 × 1200 × 50mm

Min Workpiece Dimensions:  
200 × 50 × 10mm



## Drill Bank

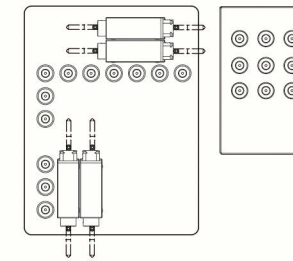

Panel hold-down device with rubber feet guarantees accurate processing



Grippers are automatically positioned to accommodate different sized workpieces

In-feed & Out-feed both from the Front End:

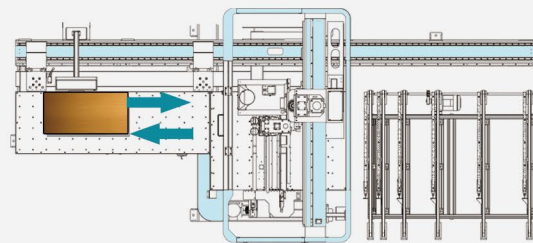

In-feed from the Front End, Out-Feed from the Rear End:

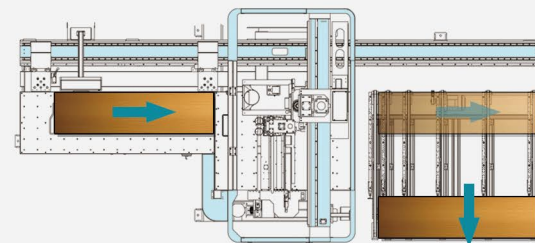

SCAN TO  
WATCH VIDEO



## E6 PTP WORK CENTER



### Features

- ◆ An all-rounder work center suitable for drilling, routing, sawing and other applications.
- ◆ Ideal for panel furniture, solid wood furniture, office furniture, wooden door productions, as well as other non-metal and soft metal applications.
- ◆ Double work zones guarantee non-stop work cycle—operator can load and unload workpiece on one zone without interrupting the machine operation on the other.
- ◆ Features world's first class components and strict machining procedures. The enclosure over the gantry with LED light strip for display of the machine status prevents flying out of materials and greatly enhances safety.
- ◆ The operator needs only to scan the barcode and the machine will carry out the job automatically.

18 moveable vacuum cups, in 3 different sizes to work with various panel sizes



### Truly Versatile

This machine is also commonly used to manufacture solid wood door. You have the option to upgrade to a more powerful spindle and to use heavy duty aggregates to perform the job required



Pod-and-rail table that is divided into 2 work zones. This machine is mainly used to make solid wood door or for panel processing

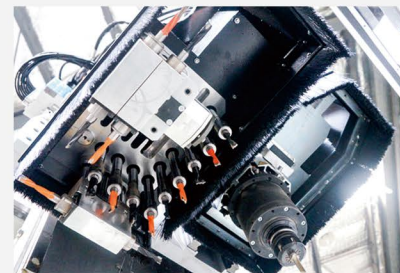

HSD Spindle: 9.6kW  
(Higher power available upon request)  
Italian drill bank: 9 vertical+6 horizontal  
+1 saw drills

## E3 PTP WORK CENTER



E3-0924



Scan the barcode and set this machine in motion



This aluminum protrusion located at the end of the machine helps the operator to slide the workpiece on with ease.



- 5.5kW spindle, max 18000rpm
- Italian 9 vertical+6 horizontal+1 saw drill bank

### Features

This all-rounder work center that meets the demands of every budget is suitable for milling, routing, drilling, side milling, sawing and various other applications.

Ideal for panel furniture, solid wood furniture, office furniture, wooden door productions, as well as other non-metal and soft metal applications.

Features world's first class components and strict machining procedures.



E3-0930

Need continuous operation? Upgrade to the double work zone model.



SCAN TO  
WATCH VIDEO



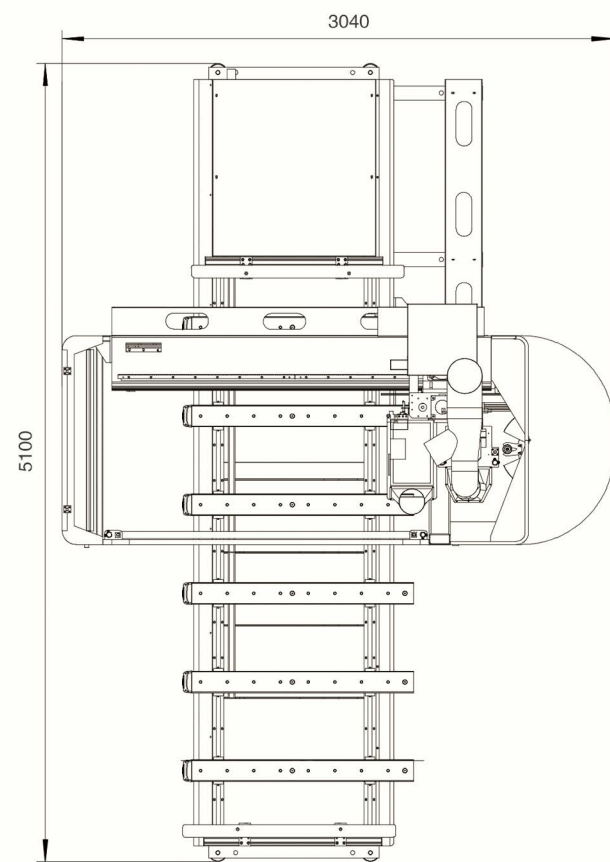

E6 PTP WORK CENTER

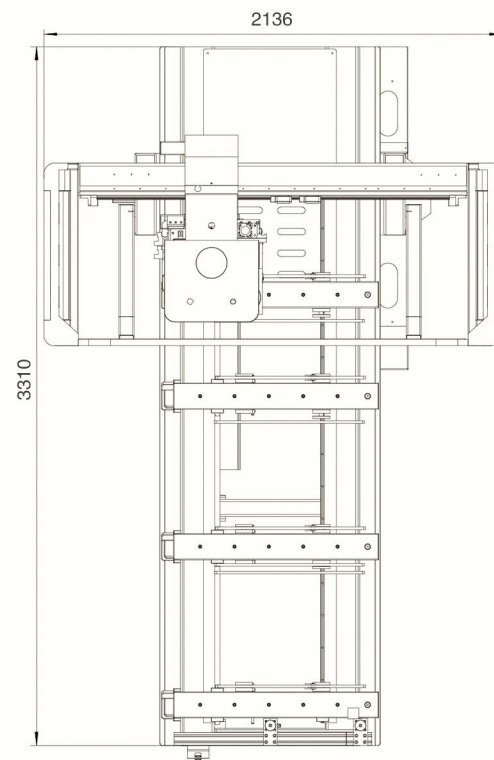

E3 PTP WORK CENTER

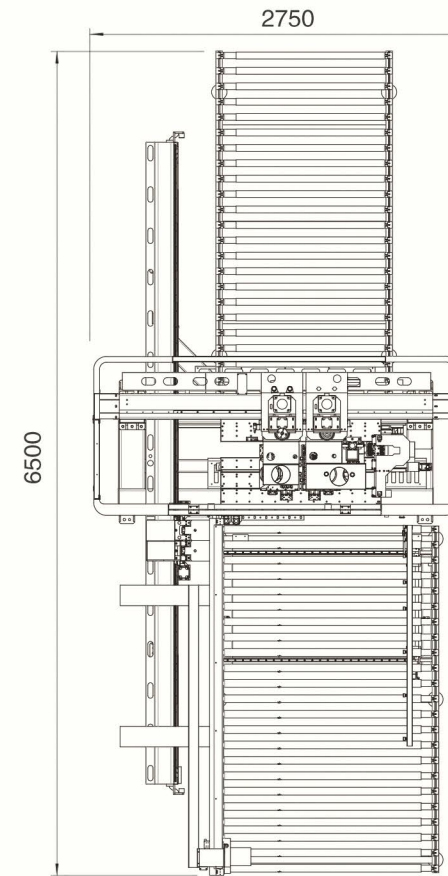

EHSAW1224 DRILLING MACHINE

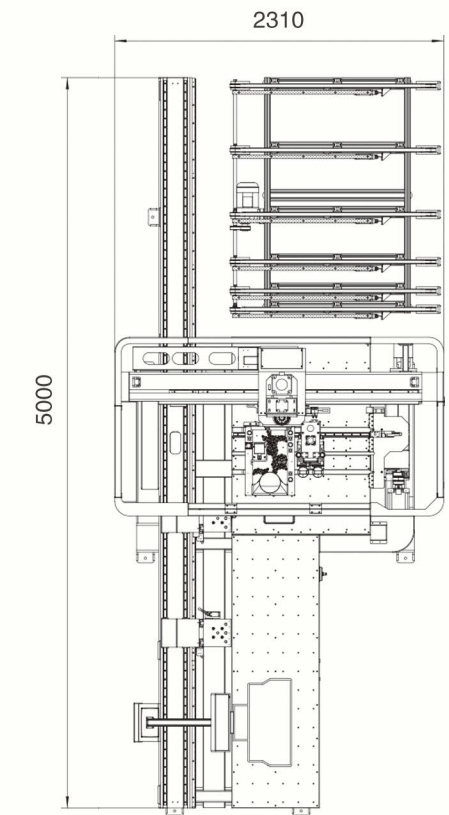

EH0924 DRILLING MACHINE

SERIES	E6-1230D	E6-1252D	E3-0924	E3-0930
Traveling Size	3400x1640x250mm	5550x1640x250mm	1310x2720x160mm	1310x3330x160mm
Working Size	3060x1260x100mm	5200x1260x100mm	900x2440x80mm	900x3050x80mm
Table Size	3060x1200mm	5200x1200mm	900x2440mm	900x3050mm
Transmission	X/Y rack and pinion drive, Z ball screw drive		X/Y rack and pinion drive, Z ball screw drive	
Table Structure	Pods and rails		Pods and rails	
Spindle Power	9.6/12.0kW		5.5kW	
Spindle Speed	24000r/min		18000r/min	
Traveling Speed	80m/min		60m/min	
Working Speed	20m/min		20m/min	
Tool Magazine	Carousel		N/A	
Tool Slots	8		N/A	
Drill Bank Config.	9 vertical+6 horizontal +1 saw blade		9 vertical+6 horizontal +1 saw blade	
Driving System	Yaskawa		Yaskawa	
Voltage	AC380/3PH/50Hz		AC380/3PH/50Hz	
Controller	OSAI/Syntec		OSAI	

SERIES	EHS 0924 ( 6 sided )	EHS 1224 ( 6 sided )	EHSAW 1224 ( Drill Bank*2 )	EH 0924	EH 1224
Traveling Size	4800x1450x150mm	4800x1750x150mm	4800x1750x150mm	4800x1300x150mm	4800x1600x150mm
Max Panel Dimensions	2440x900x50mm	2440x1200x50mm	2440x1200x50mm	2440x900x50mm	2440x1200x50mm
Min Panel Dimensions	200x50x10mm	200x50x10mm	200x50x15mm	200x50x10mm	200x50x10mm
Workpiece Transport	Air Flootation Table	Air Flootation Table	Air Flootation Table	Air Flootation Table	Air Flootation Table
Workpiece Hold-Down	Clamps	Clamps	Clamps	Clamps	Clamps
Traveling Speed	130/80/30m/min	130/80/30m/min	130/80/30m/min	130/80/30m/min	130/80/30m/min
Spindle Power	3.5kW x2	3.5kW x2	3.5kW x2	3.5kW	3.5kW
Drill Bank Config.	21 Vertical (12 Top , 9 Bottom) 8 Horizontal	21 Vertical (12 Top , 9 Bottom) 8 Horizontal	33 Vertical (24 Top , 9 Bottom) 16 Horizontal	12 Vertical 8 Horizontal	12 Vertical 8 Horizontal
Driving System	Yaskawa	Yaskawa	Yaskawa	Yaskawa	Yaskawa
Controller	Syntec	Syntec	Syntec	Syntec	Syntec

★ ALL DIMENSIONS SUBJECT TO CHANGE



# ES-1224L PRECISION BALL SCREW DRIVEN MACHINE

Auto Infeed & Outfeed Optional



This machine is designed to meet some of the more demanding or craft-oriented application requirements to whom precision is the key.

That is why we use precision ball screw on all 3 axes—to ensure a smoother and more accurate performance.



For some customers, carrying out a job will require use of multiple tools. With this machine, you have dual 8/16/18-slot tool changers to meet the diversity of your jobs.

The carousels travel with the spindle, therefore dramatically improve the overall performance by reducing the tool changing time.

### Applications

Cabinet doors, Panel furniture, cabinet, wardrobe, door, office furniture, custom furniture, solid wood furniture and door etc.



SCAN TO  
WATCH VIDEO

## Automated Cabinet Door Production Line

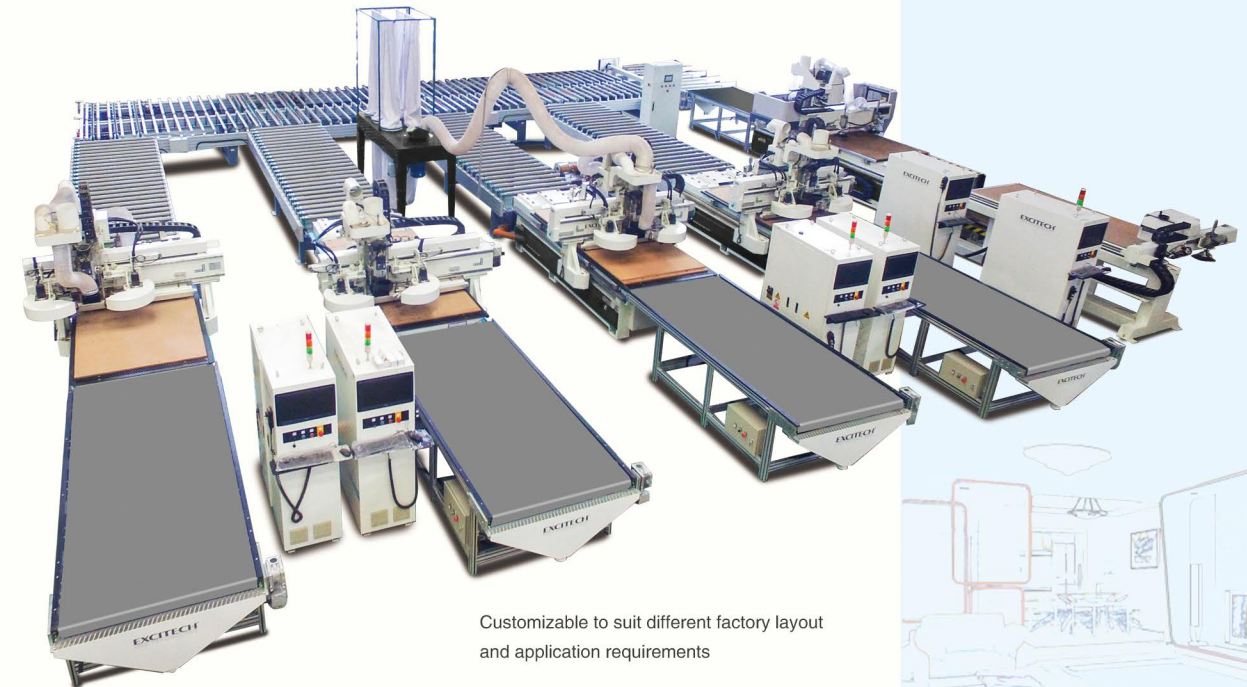

Customizable to suit different factory layout and application requirements

### Cabinet Door Production Processes:

- 1 Pre-Labeling
- 2 Drilling and Grooving
- 3 Automatic Out-feed
- 4 Panel Flipper
- 5 Return Conveyor
- 6 Engraving and Nesting

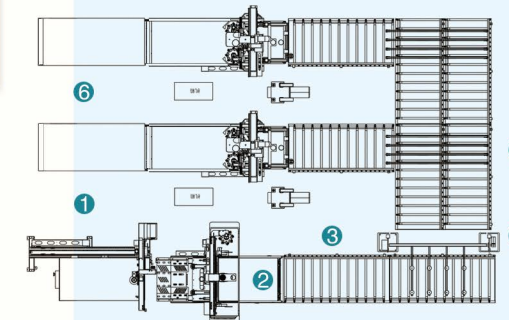
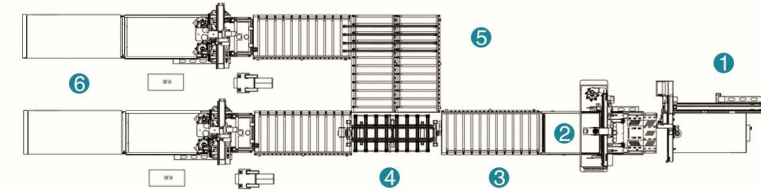

SERIES	ES-1224L
Traveling Size	2500x1260x200mm
Working Size	2440x1220x40mm
Table Size	2440x1220 mm
Transmission	X/Y/Z ball screw drive
Table Structure	Vacuum Table
Spindle Power	9.6kW
Spindle Speed	24000r/min
Traveling Speed	40m/min
Working Speed	15m/min
Tool Magazine	Carousel
Tool Slots	16 / 32 / 36
Driving System	Yaskawa
Voltage	AC380/3PH/50Hz
Controller	Syntec



# E10 VANTAGE FIVE-AXIS MACHINING CENTER



### Applications

Composite material applications, sanitary ware molds, automobile molds, boat and yacht, solid wood furniture, 3D artwork, etc.

Real-Time Tool Center Point Rotation (RTCP)  
Z axis height can be extended to cater for extra-large and extra-thick 3D processing.

### 5-Axis application software solution

Talk with your sales rep to find out more.

SERIES	E10-2040D	E10-3060D
Traveling Size	4800x2800x2000/2400mm	6800x3800x2000/2400mm
Working Size	4000x2000x1600/2000mm	6000x3000x1600/2000mm
A/C Axis	A: ± 120° C: ± 245°	
Transmission	XY/Z rack and pinion drive	
Spindle Power	10 / 15kW	
Spindle Speed	22000r/min	
Traveling Speed	55/55/15 m/min	
Working Speed	20m/min	
Tool Magazine	Linear 8 slots	
Driving System	Yaskawa	

Different machine dimensions available.



### Italian OSAI Control

Control unit separate from the main electrical cabinet that promises better mobility and safety.



CNC machining center with 5 synchronizing interpolated axes

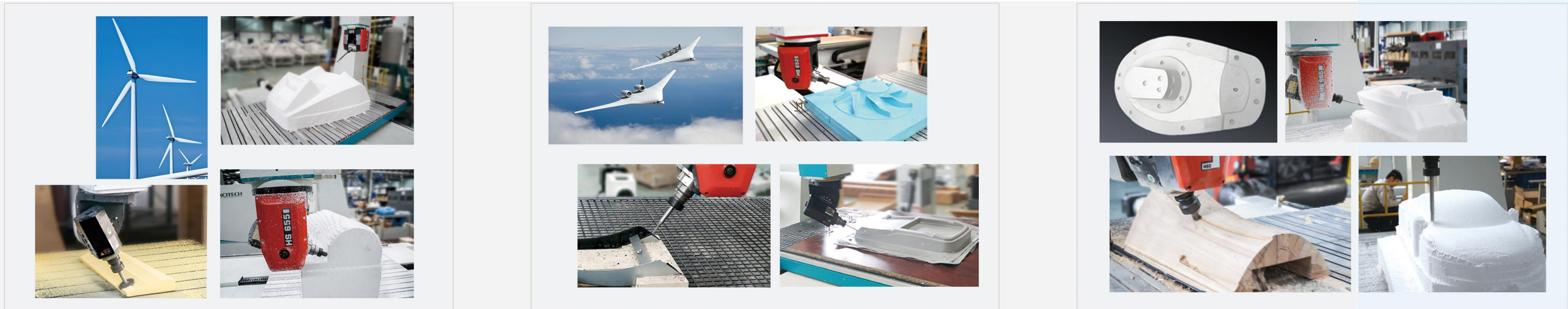



# E9 VENTURE FIVE-AXIS MACHINING CENTER

## Features

- ◆ **RELIABILITY:** This five-axis machining center is outfitted with a renowned Italian-made controller that is designed for the most demanding processing requirements. It features maximum precision, easy operation, and productive efficiency.
- ◆ **VERSATILITY:** CNC machining center equipped with 5 synchronizing interpolated axes and Real-Time Tool Center Point Rotation (RTCP); Z axis height can be extended to cater for extra-large and extra-thick 3D processing.
- ◆ **STATE-OF-THE-ART EFFICIENCY:** Working speed, travelling speed and cutting speed can all be controlled separately to dramatically improve productivity and output quality.

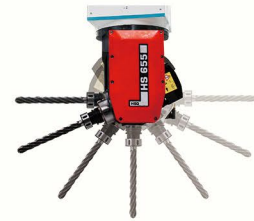

CNC machining center with 5 synchronizing interpolated axes

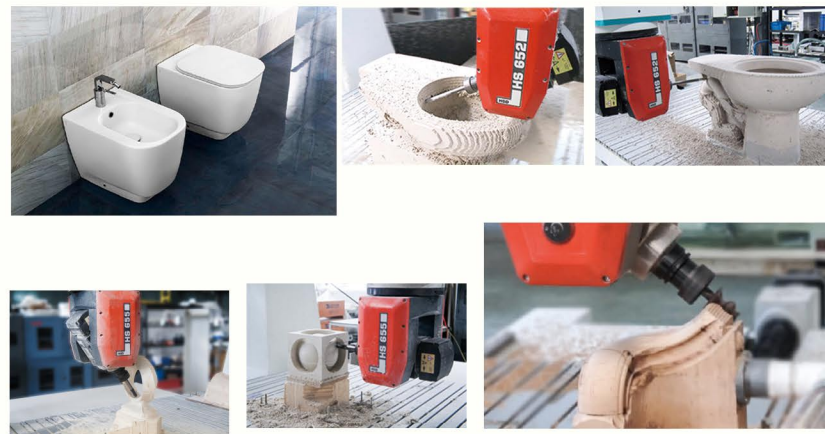

## Twin Table Optional:

Twin table design doubles the productive efficiency by allowing loading and unloading operations on one station without interrupting the work cycle.

## JOIN HANDS WITH OUR WORLD-RENOUNDED PARTNERS



Japanese THK Linear Guide Rail



German Helical Rack

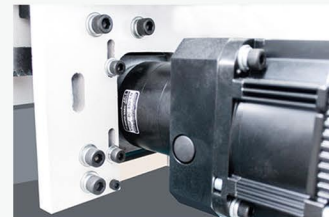

Japanese Shimpo Planetary Gear Box



Italian OSAI Controller



Japanese Driving System



German Cable Conductor

SERIES	E9-1224D	E9-1530D	E9-2030D
Traveling Size	1850x3100x950/1300mm	2150x3700x950/1300mm	2650x3700x950/1300mm
Working Size	1200x2400x650/1000mm	1500x3000x650/1000mm	2000x3000x650/1000mm
Table Size	1200x2400mm	1550x3050mm	2100x3050mm
A/C Axis	A: ±120° C: ±245°		
Transmission	Y rack and pinion drive, X/Z ball screw drive		
Spindle Power	10 / 15kW		
Spindle Speed	22000r/min		
Traveling Speed	60/60/20 m/min		
Working Speed	20m/min		
Tool Magazine	Carousel 8 slots		
Driving System	Yaskawa		



## E8 MINI FIVE-AXIS MACHINING CENTER



### Features

- ◆ An entry-level five-axis machining center with world top-class controller—designed for the most demanding processing requirements, featuring maximum precision, and all-round excellence.
- ◆ CNC machining center with 5 synchronizing interpolated axes; Real-Time Tool Center Point Rotation (RTCP), well suited for 3D processing.

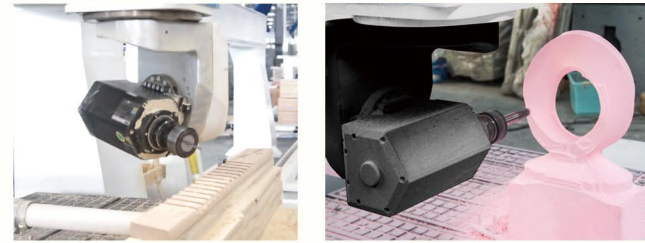

SERIES	E8-1212D	E8-1224D
Traveling Size	1720x1820x750mm	1720x3040x750mm
Working Size	1220x1220x500mm	1220x2440x500mm
Table Size	1230x1220mm	1230x2440mm
A/C Axis	A: ± 185° C: ± 320°	
Transmission	X/Y rack and pinion drive, Z ball screw drive	
Spindle Power	8.5kW	
Spindle Speed	24000r/min	
Traveling Speed	60/60/20 m/min	
Working Speed	20m/min	
Tool Magazine	Carousel 8 slots	
Driving System	Yaskawa	

### Twin Table Optional:

Twin table design doubles the productive efficiency by allowing loading and unloading operations on one station without interrupting the work cycle.



SCAN TO  
WATCH VIDEO

## CENTER FOR MOLD INDUSTRY SHLS2040

- ◆ Features self-lubricating, life-long maintenance-free Japanese guide rail.
- ◆ Italian high-speed spindle, with top speed of 10000 RPM, guaranteeing maximum processing efficiency and productivity.
- ◆ Whole working table cast by resin sand. The annealing and other heat treatment methods ensure that the whole structure is tested to the limit for sturdiness and reliability.



## FOUR-AXIS MACHINING CENTER



Pendulum Spindle  
Movement: ± 90°



SERIES	SHLS 1525	SHLS 2040	SHLS 2450	FOUR AXIS
Traveling Size	2500x1500x800mm	4000x2000x800mm	5000x2400x800mm	2500x1260x420mm or 3100x2100x420mm
Transmission	X/Y rack and pinion drive, Z ball screw drive			X/Y rack and pinion drive, Z ball screw drive
Traveling Speed	≥ 16000mm/min			≥ 45000mm/min
Working Speed	≥ 10000mm/min			≥ 20000mm/min
Spindle Power	7.5kW / 9.6 kW			9.6kW
Spindle Speed	18000r/min			24000 r/min
Driving System	Yaskawa			Yaskawa
Controller	Syntec			Syntec/OSAI



# E7 MOVEABLE TABLE WORK CENTER

*Designed for solid wood processing, sofa and other upholstery furniture processing with high speed, heavy duty structure and movable bed.*



## Features

- ◆ Rapid switch between the two heads for different applications helps to save your precious time and enhance flexibility and value.
- ◆ Two tool magazines up to 16 slots—multiply your choices and cater to your appetite for variety.
- ◆ Working speed, travelling speed and cutting speed can all be controlled separately, dramatically improve productivity and output quality.



This machine is designed to hold aggregates as well.



This machine is designed to meet some of the more demanding or craft-oriented application requirements to whom precision is the key. That is why we use precision ball screw on all 3 axes --to ensure a smoother and more accurate performance

For some, carrying out a job will require use of multiple tools. With this machine, you have 16-slot tool changer to meet the diversity of your jobs. The carousels travel with the spindle, therefore dramatically improve the overall performance by reducing the tool changing time.



## Double Efficiency with Double Spindles!

- ◆ Designed with double spindles, and double tool magazines that enable synchronous operation.
- ◆ Manufactured for heavy-duty operations and equipped with a moveable table.
- ◆ Two heads can work individually, or do the same job simultaneously—more than doubles the efficiency!

SERIES	E7-1530D	E7-3020D
Traveling Size	1600x3100x250mm	3040x2040x250mm
Working Size	1550x3050x200mm	3000x2000x200mm
Table Size	1530x3050mm	3050x1980mm
Transmission	X/Y rack and pinion drive, Z ball screw drive	
Table Structure	Vacuum Table	
Spindle Power	9.6kW / 12.0kW	
Spindle Speed	24000r/min	
Traveling Speed	60 m/min	
Working Speed	20m/min	
Tool Magazine	Carousel	
Tool Slots	8x2	
Driving System	Yaskawa	
Voltage	AC380/3PH/50Hz	
Controller	OSAI / Syntec	



## E5 HEAVY-DUTY WORK CENTER



Drill Bank, Pop-up Position Pins Optional

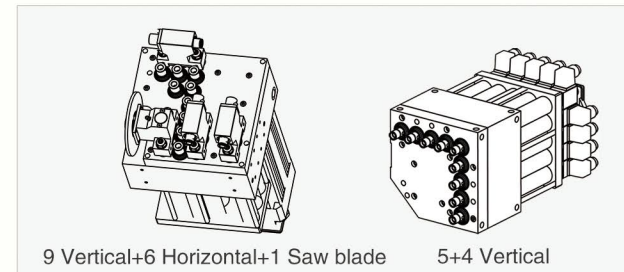

For some, carrying out a job will require use of multiple tools. With this machine, you have 8-slot tool changer to meet the diversity of your jobs. The carousel travels with the spindle, therefore dramatically improves the overall performance by reducing the tool changing time.

### APPLICATIONS

- ◆ Furniture: ideally suitable for processing cabinet doors, wooden doors, solid wood furniture, panel furniture, office furniture, windows, tables and chairs, etc.
- ◆ Other wooden products: stereo box, computer desk, musical instruments, etc.
- ◆ Well-suited for processing panels, insulating materials, plastics, epoxy resin, carbon mixed compound, etc.



### Features

- ◆ Extremely heavy-duty with an 8-slot carousel tool changer, for accurate and rapid tool positioning.
- ◆ Versatile: routing, drilling, cutting, side milling, edge chamfering, etc. Boring aggregate an option.
- ◆ T-slot vacuum table with great absorption strength—absorb on multi-zone or clamp with pop-up positioning pin, it is your call.

## E3 VENTURE WORK CENTER



### Features

- ◆ An entry-level work center—an extraordinary solution with competitive price.
- ◆ Versatile functions: routing, drilling, cutting, side-milling, edge chamfering, etc.
- ◆ Pusher optional.



Servo tool changer with 12/16 slots available upon request. Tool changing is faster and more accurate. A more efficient option for those who work with a multitude of different tools, such as the cabinet door manufacturing.



SCAN TO  
WATCH VIDEO

SERIES	E3-1325D	E3-1530D	E3-2030/2040D	E5-1224D	E5-1530D	E5-2030/2040D
Traveling Size	2500x1260x200mm	3100x1570x200mm	3100/4030x2060x200mm	2500x1260x330mm	3100x1570x330mm	3350/4350x2100x330mm
Working Size	2480x1230x180mm	3080x1560x180mm	3080/4000x2050x180mm	2480x1230x200mm	3080x1560x200mm	3050/3940x2032x200mm
Table Size	2500x1230mm	3100x1560 mm	3100/4030x2050mm	2500x1240mm	3100x1570 mm	3100/4020x2100mm
Optional Working Length			2850/5000/6000mm			2850/5000/6000mm
Transmission	X/Y rack and pinion drive, Z ball screw drive			X/Y rack and pinion drive, Z ball screw drive		
Table Structure	Vacuum Table			Vacuum Table		
Spindle Power	9.6kW			9.6 / 12.0kW		
Spindle Speed	24000r/min			24000r/min		
Traveling Speed	45m/min			80m/min		
Working Speed	20m/min			20m/min		
Tool Magazine	Carousel			Carousel		
Tool Slots	8/12/16			8/12/16		
Driving System	Yaskawa			Yaskawa		
Voltage	AC380/3PH/50Hz			AC380/3PH/50Hz		
Controller	OSAI / Syntec			OSAI / Syntec		



# MTC / ATC PRODUCT RANGE

## E1/E2 ATC PRODUCT



- ◆ High-performance machine with extraordinary value, but at a very economical price.
- ◆ With linear tool changer, constructed with world-class components, consistent high performance.
- ◆ Featuring Italian high frequency air-cooling electronic spindle and world-class servo motor and driving system.
- ◆ Rigid vacuum table with grids and T-slots maximizes the vacuum hold-down power and also enables you to clamp the workpiece in place.
- ◆ Smart industrial controller—enabling this product to accomplish multi-layer 3D job, cutting, engraving, milling, all at ease.



## E2-1325-III

- ◆ Tripartite head machining
- ◆ Servo drive system
- ◆ Adopt world-class top brand components
- ◆ Taiwan controller

### Applications

- ◆ Furniture Industry: Panel Furniture, Office Furniture, Wood Door, Cabinet, etc;
- ◆ Wood-working Industry: Musical Instrument, Kitchen Doors, Windows, etc;
- ◆ Suitable Material: Wood, Solid Wood, Panel, Acrylic, Plexiglass, MDF, Plastic, Copper, Aluminum, etc.

SERIES	E2-1325-III
Working Area	2440x1220x200mm
Transmission	X/Y rack and pinion drive, Z ball screw drive
Table Structure	T-slot vacuum table
Spindle Power	4.5/6.0/4.5 kW
Spindle Speed	18000 rpm/min
Traveling Speed	30000mm/min
Working Speed	15000mm/min
Driving System	Panasonic servo drivers and motors
Voltage	AV380V/3PH/50Hz
Controller	Syntec
Net Weight	2300kg
Gross Weight	2300kg



## E1/E2 MTC PRODUCT

- ◆ Your perfect beginner machine: manual tool changing, featuring German helical rack and pinion drive, Japanese maintenance free linear guides—it has an excellent performance and price ratio. Ideal for hobby users and businesses with limited budget.
- ◆ Rigid vacuum table with grids and T-slots maximizes the vacuum hold-down power and also enables you to clamp the workpiece in place.
- ◆ Highly efficient machine permitting faster production, cutting speed over 18m/min. Low vibration and smooth motion ensure higher workpiece quality.



### Applications

- ◆ Furniture: ideally suitable for processing cabinet door, wooden door, solid wood furniture, panel furniture, windows, tables and chairs, etc.
- ◆ Other wooden products: stereo box, computer desk, musical instruments, etc.
- ◆ Well-suited for processing panel, insulating materials, plastic, epoxy resin, carbon mixed compound, etc.
- ◆ Decoration: acrylic, PVC, density board, artificial stone, organic glass, soft metals

SERIES	E2-1325	E2-1325C	E2-1530	E2-1530C	E2-2030/2040	E2-2030C/2040C
Traveling Size	2500x1260x200/300mm		3100x1570x200/300mm		3100/4020x2100x200/300mm	
Working Size	2480x1230x180/280mm		3080x1550x180/280mm		3080/4000x2050x180/280mm	
Table Size	2500x1230mm		3100 x1560mm		3100/4020x2050mm	
Optional Working Length					3000/5000/6000mm	
Transmission	X/Y rack and pinion drive, Z ball screw drive		X/Y rack and pinion drive, Z ball screw drive		X/Y rack and pinion drive, Z ball screw drive	
Table Structure	T-slot Vacuum/T-slot	T-slot Vacuum	T-slot Vacuum/T-slot	T-slot Vacuum	T-slot Vacuum/T-slot	T-slot Vacuum
Spindle Power	3.0/4.5/6.0kW	9.6kW	3.0/4.5/6.0kW	9.6kW	3.0/4.5/6.0kW	9.6kW
Spindle Speed	18000r/min	24000r/min	18000r/min	24000r/min	18000r/min	24000r/min
Traveling Speed	25m/min	40m/min	25m/min	40m/min	25m/min	40m/min
Working Speed	15m/min	18m/min	15m/min	18m/min	15m/min	18m/min
Driving System	Stepper/Yaskawa	Yaskawa	Stepper/Yaskawa	Yaskawa	Stepper/Yaskawa	Yaskawa
Controller	Hand-Held Controller	Syntec/OSAI	Hand-Held Controller	Syntec/OSAI	Hand-Held Controller	Syntec/OSAI