

# **CLASS C 504 - C 600**



*Electronic edgebander with hot melt glue and  
PRE-MILLING UNIT included*

## **C 504 and C 600**

**WITH PATENTED PRE-MILLING UNIT  
FOR AN HIGH-QUALITY EDGEBANDING**

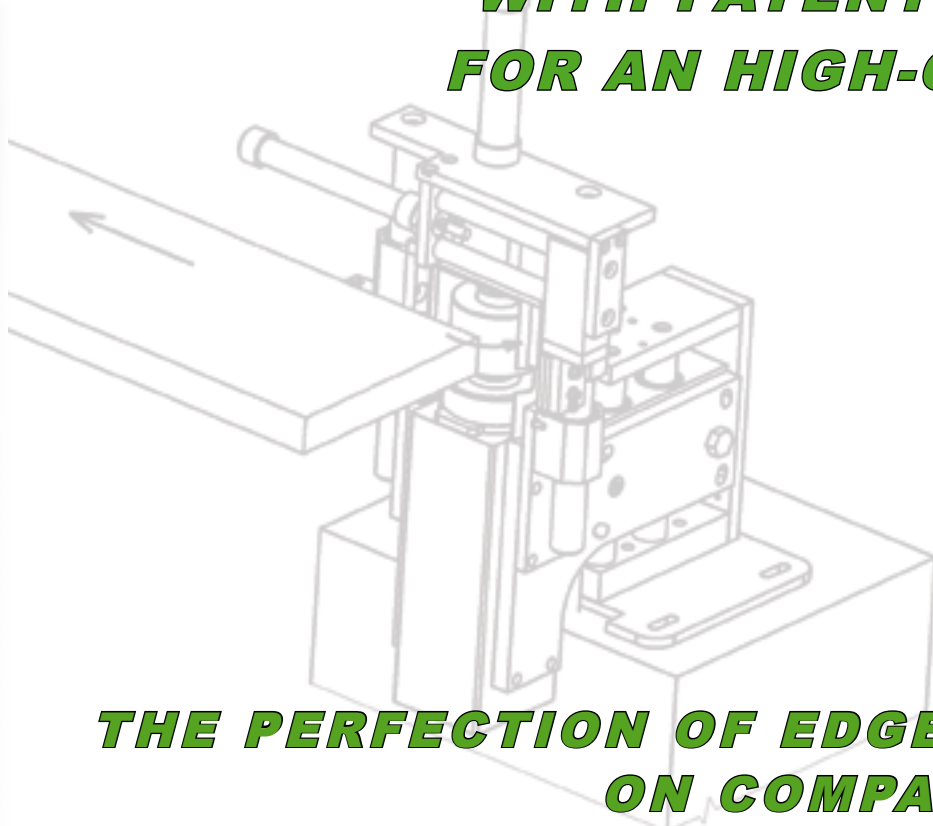

**THE PERFECTION OF EDGEBANDING WITH PRE-MILLING ALSO  
ON COMPACT EDGEBANDERS**

- TO ELIMINATE CHIPPING CAUSED BY PANEL'S CUTS**
- TO ELIMINATE THE TAPERED CUT OF SCORING UNIT**
- TO ELIMINATE SWELLING DUE TO DAMPNES**

Class C 504 with its exclusive patented pre-milling unit, joins simpleness and technology with low investments. That's possible thanks to an innovation simple to use that represents a real revolution in panel edgebanding quality, eliminating any defects of hewing, chipping, cut and swelling due to dampness.

C 504 is an electronic edgebander completely controlled from board, compact and flexible that with its PATENT exceeds the pre-milling panel technology known until today and it extends it also to small and medium companies.

A simple technology that allows to reach high performance and a decimal precision like the one of the bigger industrial edgebanding plants.

Technologies inaccessible in the past, with C 504 become a constant.

## C 504



0,4 - 3 mm

8 m

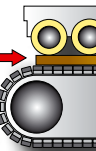
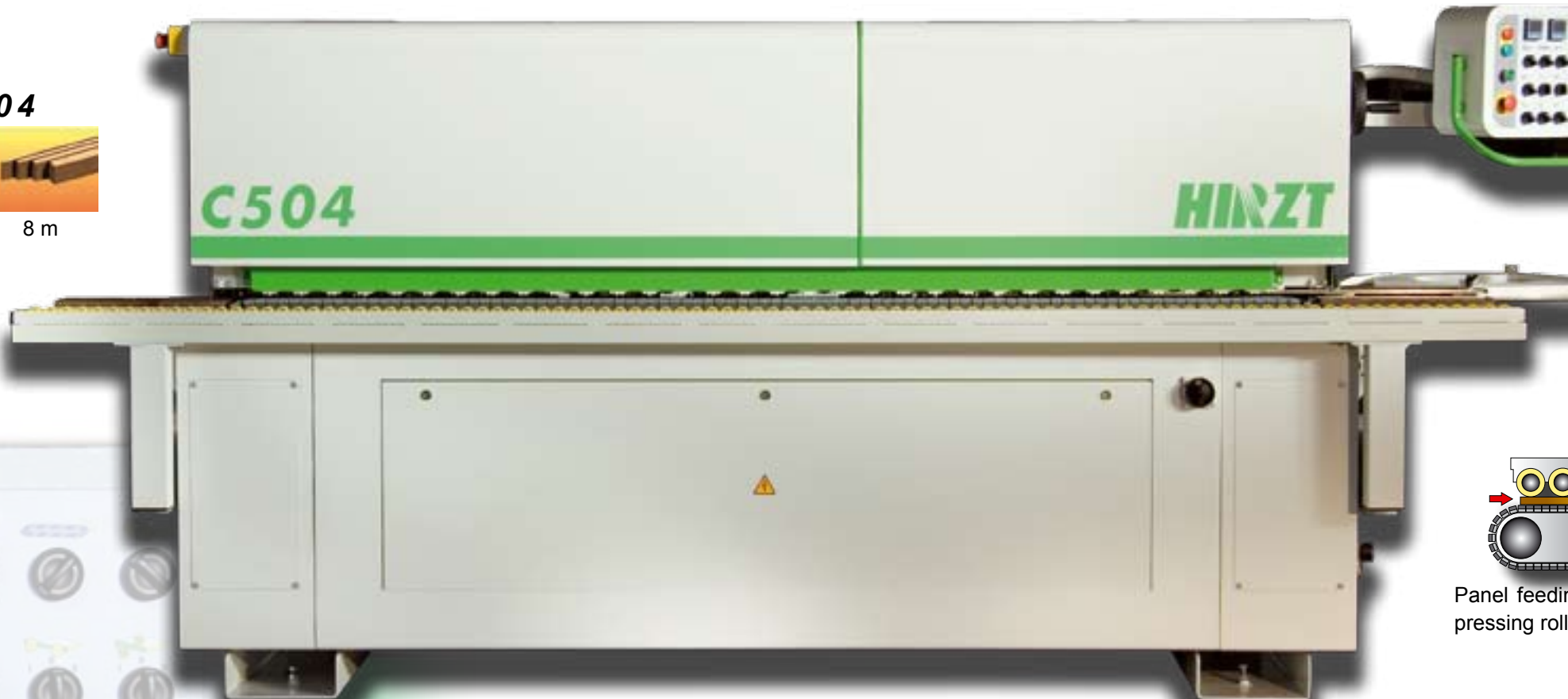

Panel feeding  
pressing roller

Equipped with an heavy panel feed track and top pressing rollers. Class C 504 grants a panel feeding of high precision and an extraordinary quality of process. Moreover, the pre-milling unit eliminates all chipping caused by panel cuts and any defects (tapered cuts or squaring errors), correcting any cut's imperfections and eliminating possible swelling due to dampness.

# C 504

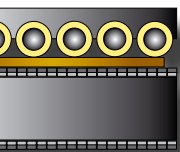

ing system with  
ers

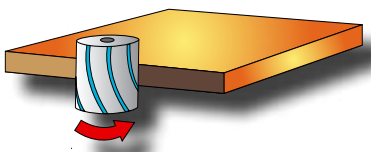

Pre-milling unit with a single motor

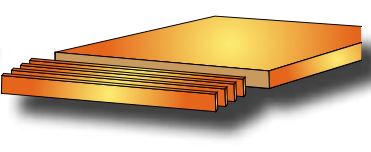

Automatic loading magazine system

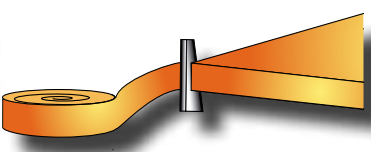

Roll tape guillotine

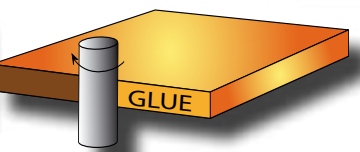

Teflon glue pot

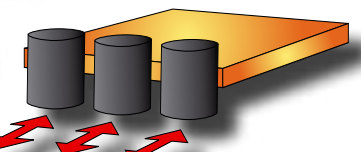

independent pressure rollers

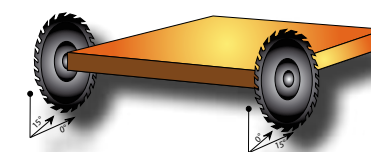

15° tiltable end trimmer (Opt. double end trimmer unit)

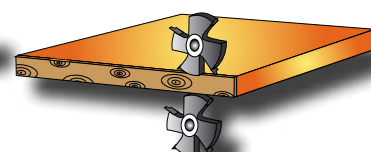

Top and bottom trimming unit for woodend stripes

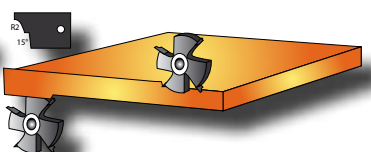

2 radius top-bottom trimmer

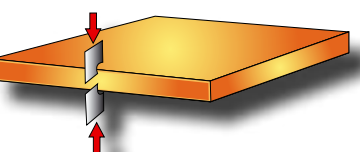

Edge-scraping unit

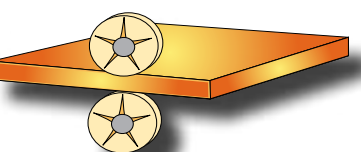

Buffing unit





All units of C 504 - C 600 require a minimum maintenance and are very simple to regulate.

The end-trimmer, thanks to its double saw (2 for front cut and 2 for back cut) grants an end-trimming of high precision, both front and back, giving the possibility to pass, directly from the control board to 15° tiltable cut.

The top and bottom trimming/roughing unit for frontal cut, selectable from control board, ensures to process wooden strips up to 8 mm.

The 2 profiles top/bottom trimmer, moreover, makes C 504/C 600 flexible and productive at the same time, by selecting, automatically from board, between 2 solutions: the edged top/bottom trimming at 15° or with radius 2 or 3 mm.

Finishing groups, such us edgescraper and buffing unit, give a high quality, correcting all imperfections and ensuring polished surfaces.



## ***Unparalleled quality***

***The pre-milling unit that only CLASS C 504 and C 600 offer as standard, brings the compact edgebanders to high level of quality and performance. Two working methods in comparison:***

TRADITIONAL EDGEBANDING WITHOUT PRE-MILLING

- Chipping
- Tapered cut of scoring unit
- Swelling due to dampness



**CLASS C** : *the future of technology and quality*

- Perfection of cut and squaring
- No chipping or defects
- Insuperable quality



# CLASS C 600



C 600, besides its patented pre-milling system as standard, includes in its equipment the electronic rounding unit, a sophisticated NC system equipped with a specific PLC for processing tapes of any type of material, wood, ABS, melaminic PVC and so on. The intuitive software allows to work a large series of programs for post-forming, following the specific design requested by the customer.



To the various programs given as standard, you can add unlimited working cycles, making C600, the best solution for a flexible and professional edgebanding.

Solid wood's process with C600 become the weakness point of production also through two important optional solutions such as the automatic loading-magazine for strips of a maximum 5 mm thickness, and the double tiltable end-trimmer of high performance that executes, separately, front and back end-trimming reaching the maximum performances.

**C 600**



0,4 - 3 mm opt. 5 mm



# C 600 IS EQUIPPED WITH:

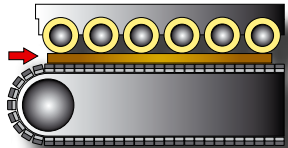

Panel feed-track with top pressing rollers

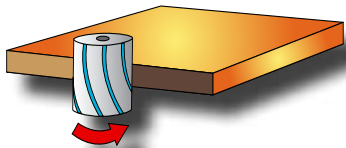

PATENTED pre-milling unit with a single motor . (Opt. diamond milling tool)

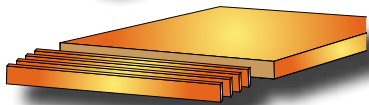

Optional automatic loading magazine



Teflon glue pot

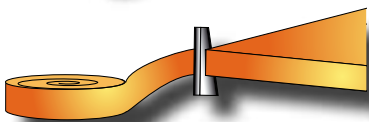

Tape guillotine

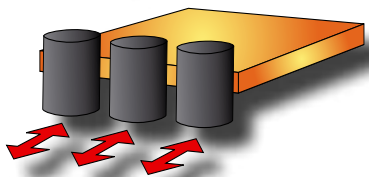

Independent pressing rollers

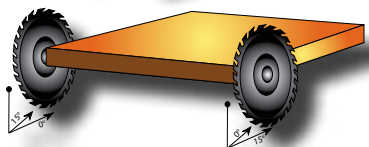

15° tiltable double saw end-trimming (double trimmer opt.)

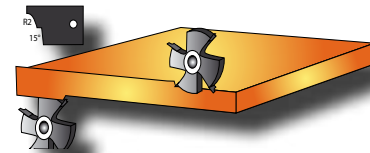

2 profiles top-bottom trimmer selectable from control board

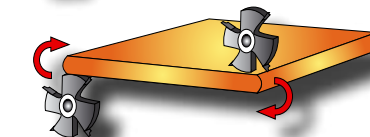

Electronic rounding unit

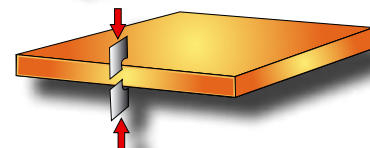

Edgescraping unit

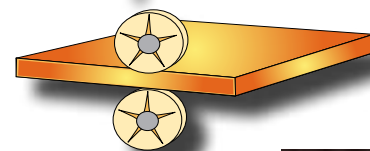

Buffing unit







A complete edgebander, but with high flexibility and easy-use, proper of all Class C.

C 600 is the authentic weakness point for edgebanding with pre-milling and rounding unit, of furniture manufacturers that aim to join the high technology of the big industries, but with low investments, following their specific production's needs.

Its easy-use, makes C 600 an edgebander manageable by not specific operators. The possibility to set all functions directly from control board, makes it suitable for any carpenter.

An investment that grants an immediate return in terms of quality and productivity.



TECHNICAL DATA	CLASS C 504	CLASS C 600
Min-max panel height	10 mm - 50 mm	10 mm - 50 mm
Min-max tape thickness	0,4 mm - 8 mm	0,4 mm - 3 mm (opt. 5 mm)
Panel feeding speed	7/8 m/min	7/8 m/min
Pneumatic pressure	6 bar	6 bar
Power	5,5 Kw	6,0 Kw
HF motors	200 Hz	200 Hz
Dimensions	cm 76 x cm 326 x h cm 150	cm 76 x cm 384 x h cm 150



**BORDATRICI  
FORATRICI  
IMPIANTI DI AUTOMAZIONE**

**HIRZT S.R.L.**  
**VIA ROVERETA, 22**  
**47853 - CERASOLO AUSA DI CORIANO (RN) - ITALY**  
**TEL. (+39) 0541-729292 FAX (+39) 0541-729294**  
**WEB SITE: WWW.HIRZT.COM E-MAIL: INFO@HIRZT.COM**

