

**OSCILLATING
BELT**

Edge Sander

**PROFESSIONAL SINGLE &
DOUBLE TYPE OSCILLATING
BELT EDGE SANDER**

CE



The all new excellent design of the double-end Oscillating Belt Edge Sander PW-12H provides precision sanding results for furniture drawers or wooden cases. Equipped with single side aluminum table for regular edge sanding jobs. Standard model PW-120E & 120ED (double table) allow for sanding on edges, plane surfaces, rims and curved surfaces, providing the right function for specific jobs.

HOLYTEK

PW-12H

Double End Oscillating Belt Edge Sander (Drawer & Case Sander)

DESIGN FEATURES:

- Max. working length and working width to 1200mm, with adjustable guide roller (extensions available on request).
- Max. working thickness to 250mm with oscillating belt for superior finishing.
- Powerful main motor: 7.5HP x 2.
- Centralized individual control panel and rollers for easy moving
- Digital readout for sizing set-up. Right side sanding unit control by separate motor and smooth traverse through "THK" linear slide way. Left side sanding unit pneumatically controlled by pedal with hydraulic stabilizer.
- With single side aluminum table for regular one side edge sanding.
- Ampere gauge for each sanding unit.
- Lubrication oil pump for moving screw shaft.

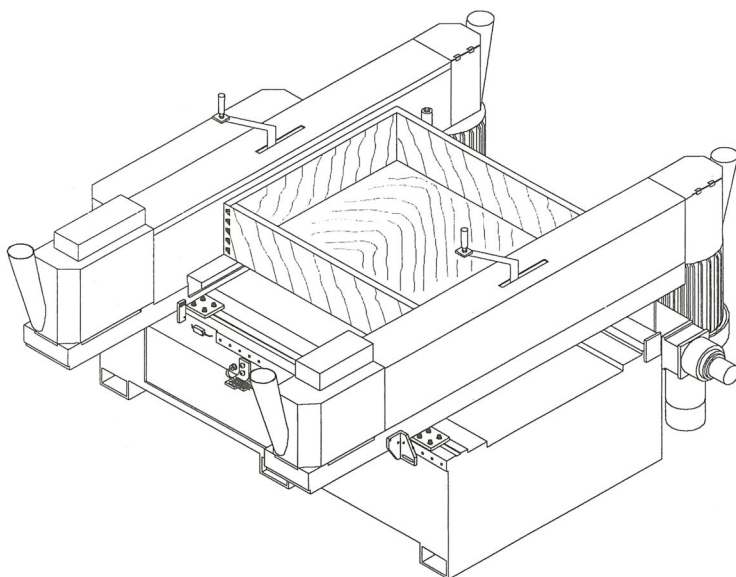

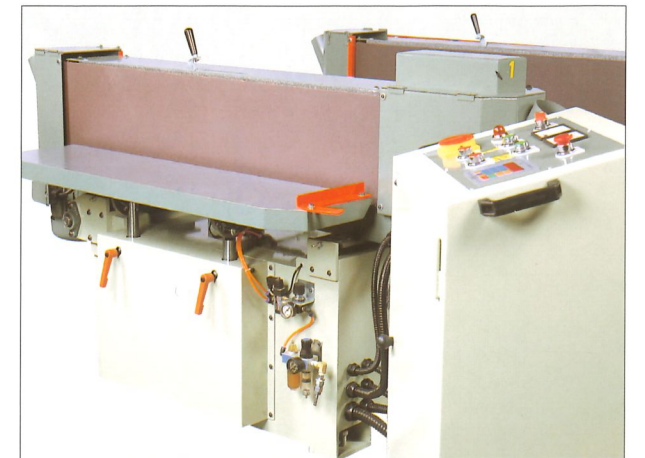
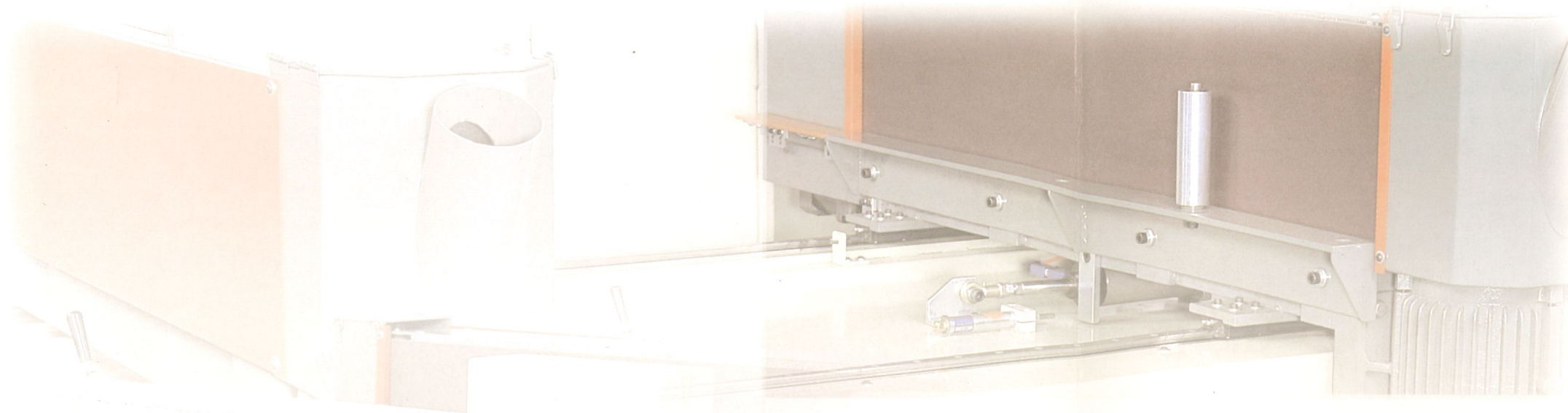

**SINGLE SIDE ALUMINUM TABLE FOR
NORMAL OSCILLATING EDGE SANDING JOBS**

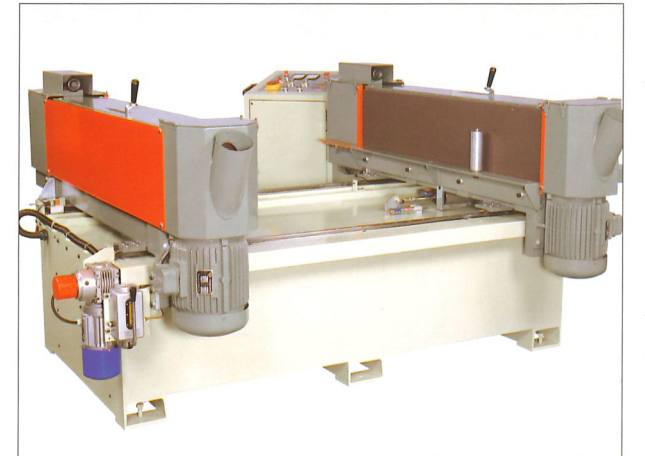

**ELECTRIC DRIVING MOTOR WITH PRECISION
WORM SCREW FOR MOVING RIGHT SIDE
SANDING UNIT**



**CENTRALIZED INDIVIDUAL CONTROL PANEL
WITH DIGITAL READOUT FOR SETTING SIZE,
AMPERE GAUGE PREVENTS OVERLOAD OF
SANDING JOBS**

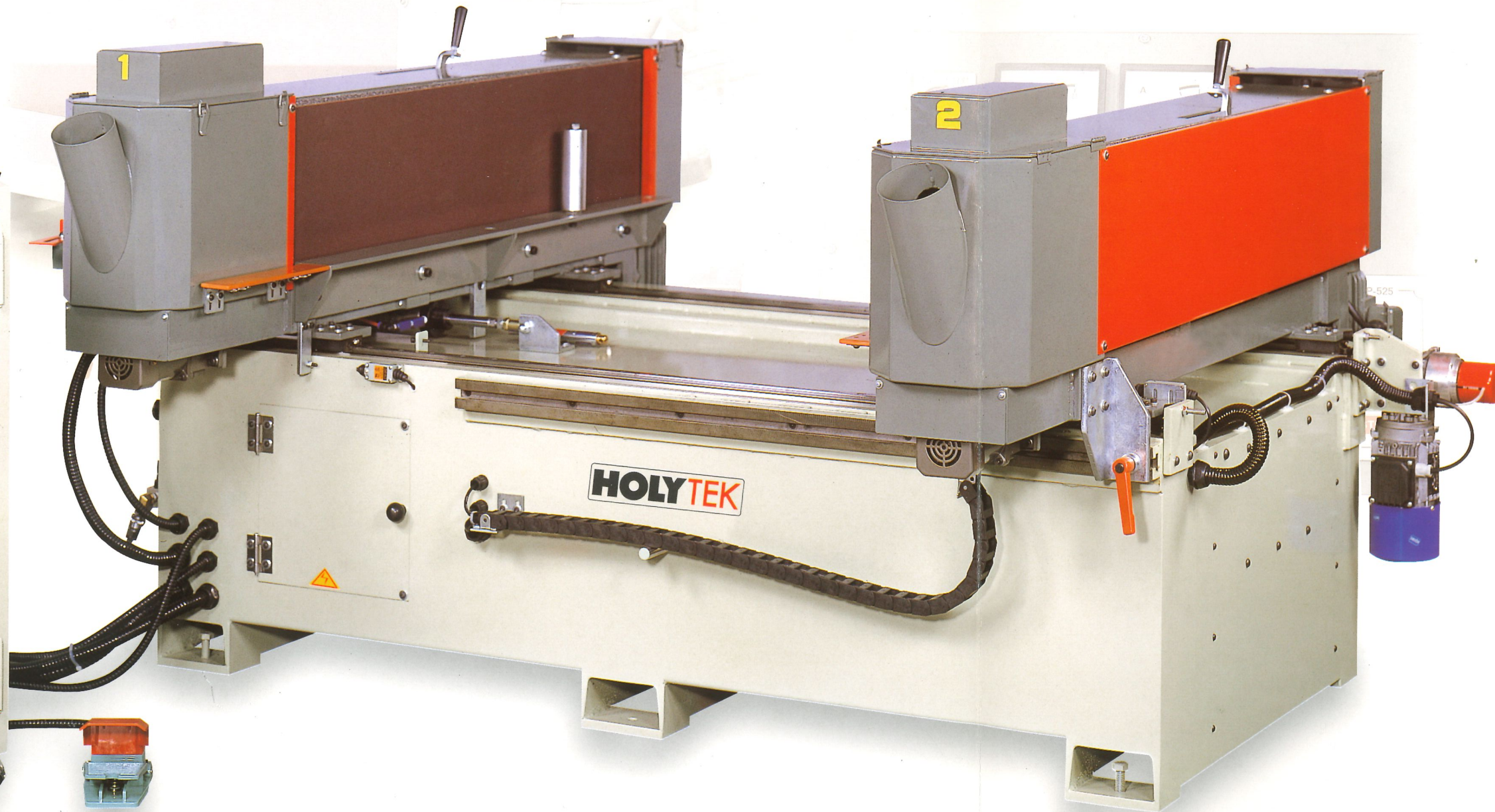

PW-12H

PW-120E

Oscillating Belt Edge Sander



PW-120E

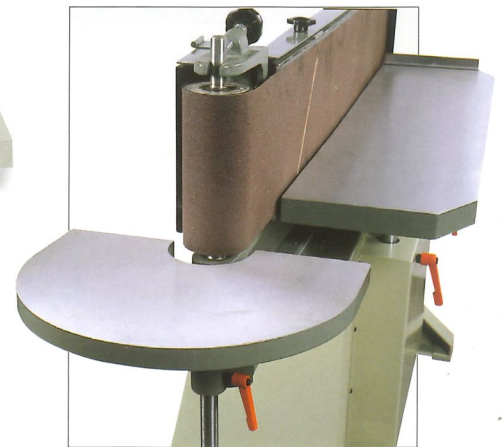

**PW-120E
CORNER SANDING TABLE FOR
CURVED SANDING**

PW-120E / 120ED FEATURES:

- New design of oscillation belt system- combination of main motor with gear device for PW-120E
- PW-120E provided with small casting table for curved corner sanding and large aluminum casting table for versatile vertical oscillating edge sanding.
- PW-120ED provided with individual motor for oscillating belt and two large aluminum casting tables, powerful motor (5 HP) for mass production.
- All tables equipped with tilting and adjustable height devices. Extremely easy to change belt and adjust belt oscillation.
- Designed for long term operation, creating superior sanding surface results.
- Two drums with rubber coated surface and balancing adjustment.

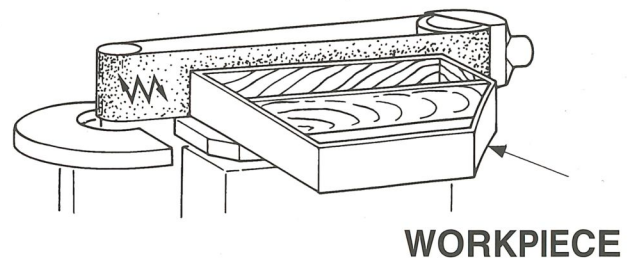

WORKPIECE

** All safety guards and dust exhaust systems comply with CE regulations.*

PW-120ED

Oscillating Belt Edge Sander With Double Table



PW-120ED

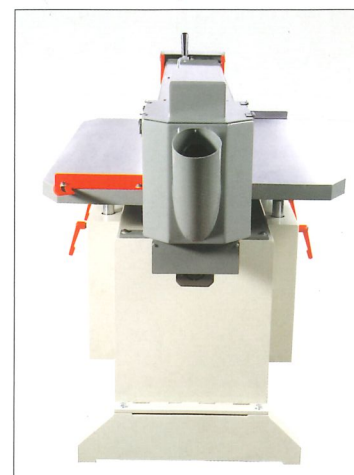

PW-120ED
DOUBLE TABLE FOR
POWERFUL SANDING

SPECIFICATIONS

MODEL	PW-12H	PW-120E	PW-120ED
Working capacity	180~1200mm (W) 1200mm (L) 10~250mm(H)	1200mm (L) x 200mm (H)	1200mm (L) x 200mm (H)
Belt size	3730mm (L) x 270mm (W)	3520mm (L) x 230mm (W)	3520mm (L) x 230mm (W)
Main motor	7.5 HP x 2	3 HP	5 HP
Oscillating motor	60W x 2	-	-
Digital setting width motor	1/4 HP	-	-
Belt linear speed	(50 Hz) 910 m/min (60 Hz) 1080 m/min	910 m/min 1080 m/min	910 m/min 1080 m/min
Machine size	235 x 215 x 115 cm	210 x 65 x 102 cm	215 x 85 x 102 cm
Packing size	245 x 225 x 130 cm	220 x 75 x 115 cm	220 x 95 x 117 cm
N.W./G.W.	1500 kgs / 1750 kgs	310 kgs / 360 kgs	380 kgs / 450 kgs

*All specifications, dimensions and design characteristics shown in this catalogue are subject to change without notice.

HOLYTEK

HOLYTEK INDUSTRIAL CORP.

9F-I, NO. 400, SEC. I, CHANG PING RD., TAICHUNG, TAIWAN, R.O.C.

TEL: 886-4-2245-2818 (REP.) FAX: 886-4-2243-6928

E-mail: holytek@ms13.hinet.net

<http://www.holytek.com.tw>