

ROOM

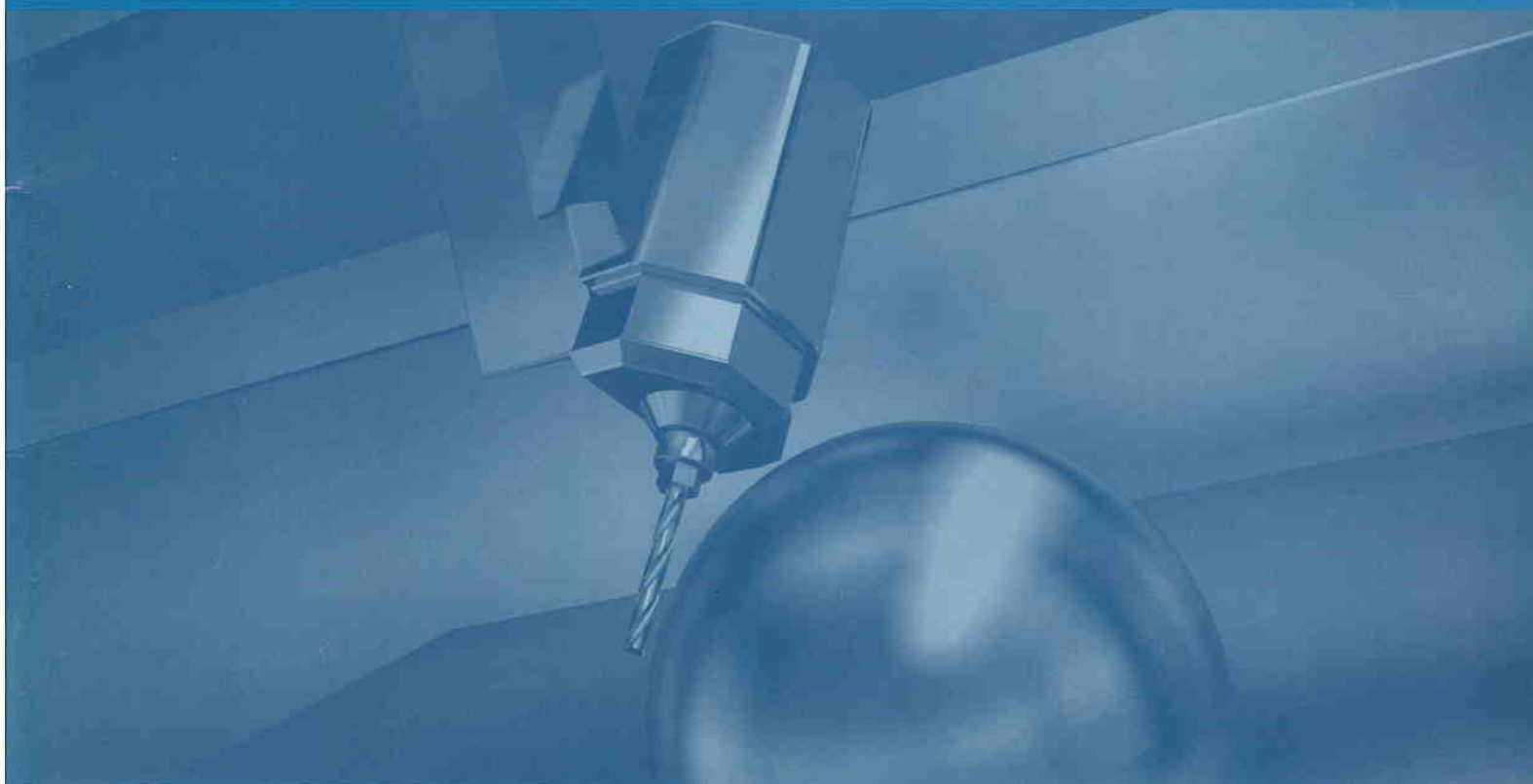

Centro di lavoro CNC
a 5 assi controllati
CNC machining centre
with 5 controlled axes

Chronos



ROUTECH

Se cerchi questo risultato...

If you want this result...

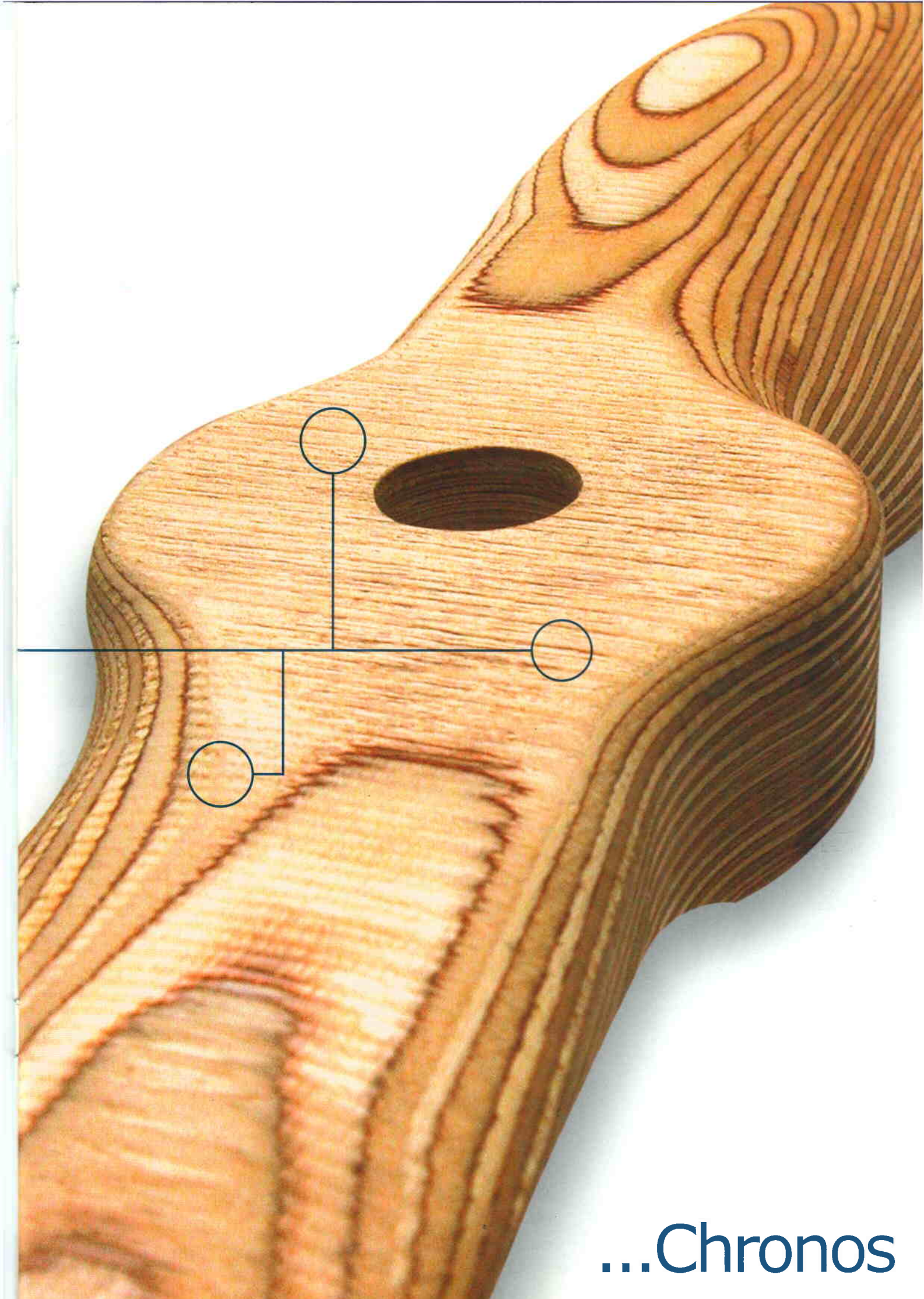

...Chronos

Chronos. Sempre al passo con i tempi
Chronos. Always in step with the times



L'evoluzione dei centri di lavoro

The evolution of machining centres

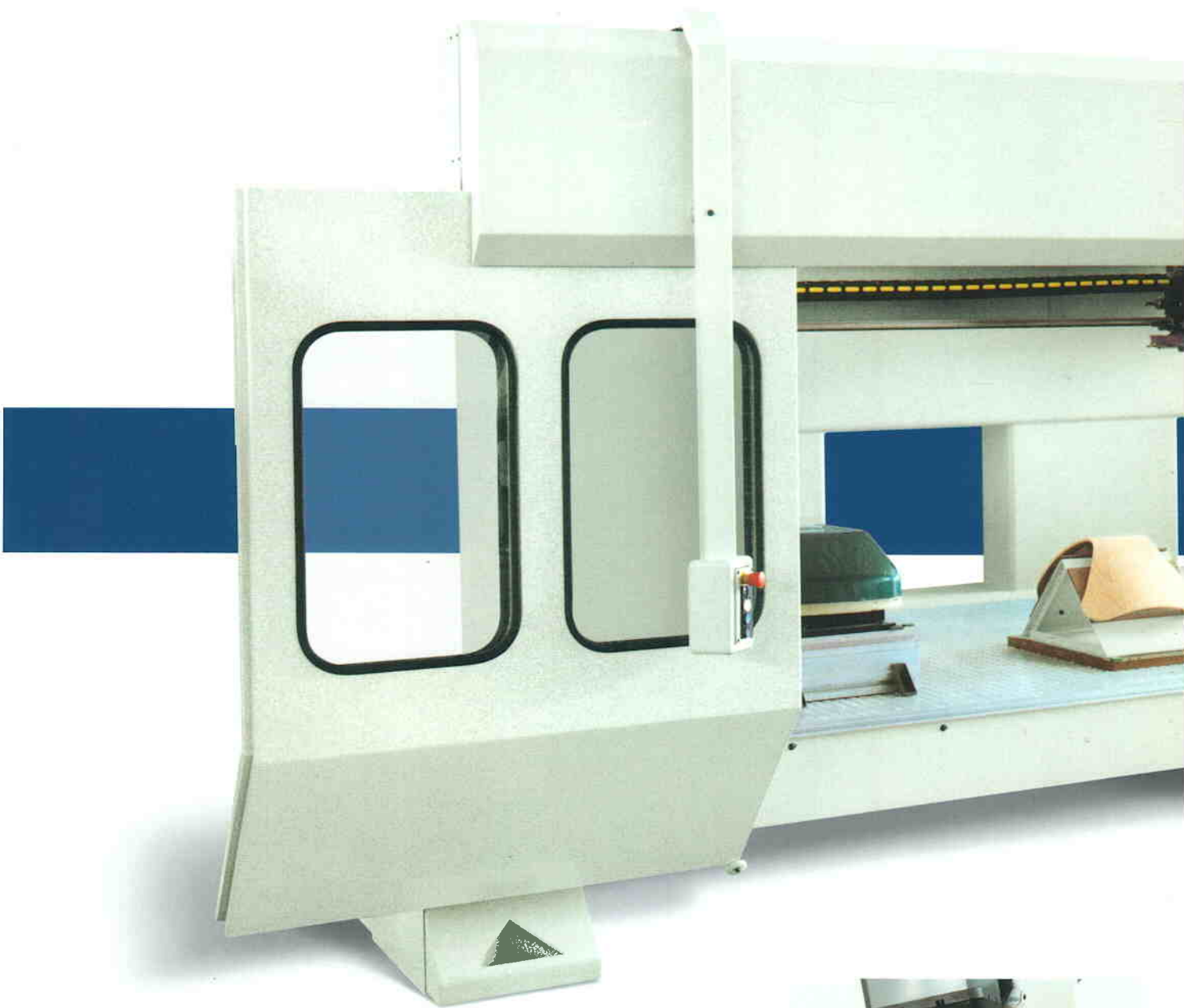

- Un centro di lavoro universale che cambia il tradizionale modo di lavorare.
- L'unione perfetta fra praticità di utilizzo e sicurezza.
- Grandi aree di lavoro nel minimo spazio.
- Massima accessibilità.

- A universal machining centre that changes conventional working methods.
- Practical use and safety in perfect harmony.
- Wide work areas in the smallest space.
- The optimum in accessibility.

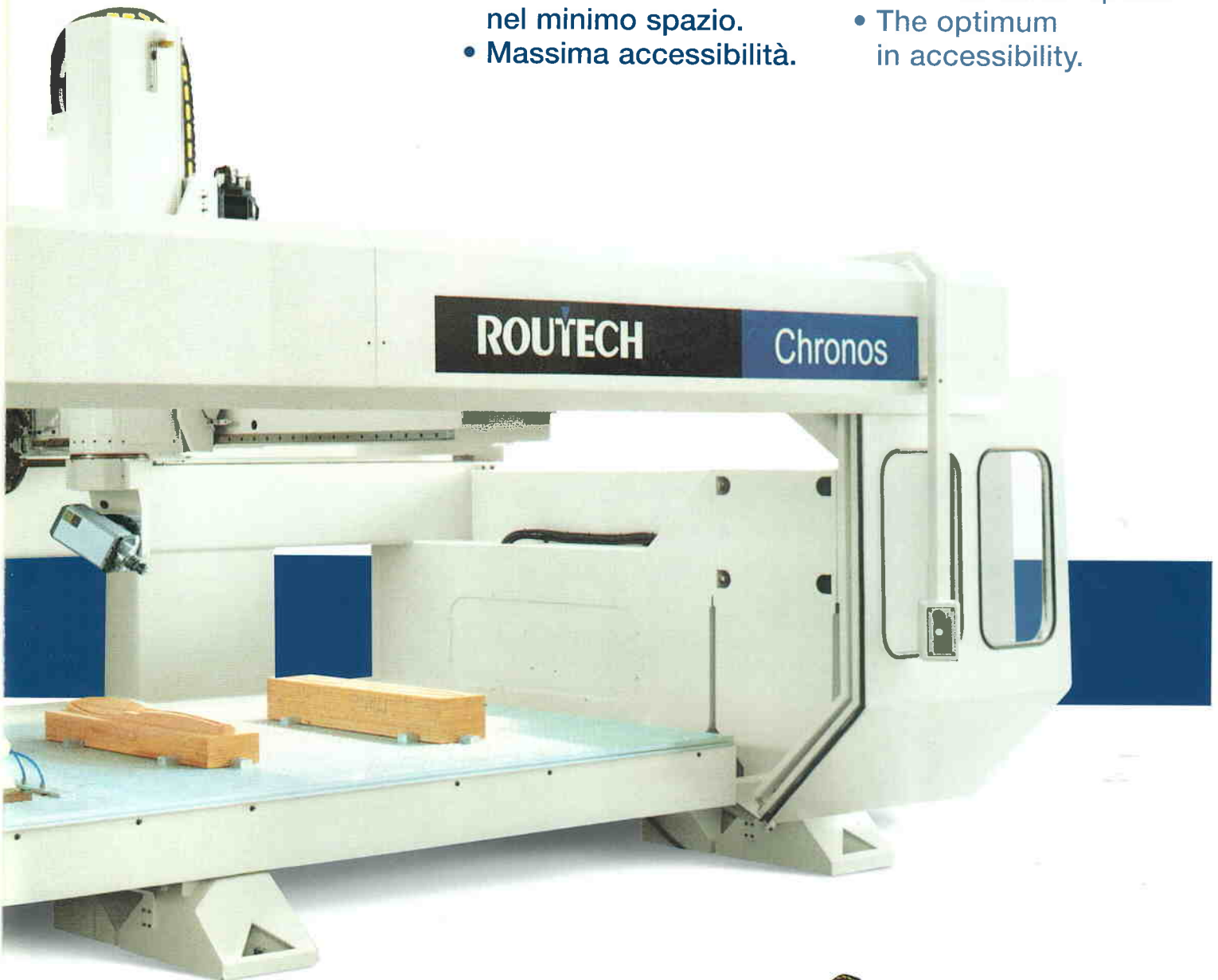

- Rigida struttura a portale.
- Dinamiche ai massimi livelli.
- Potente unità di fresatura a 5 assi.
- Lavorazioni di precisione.
- Rigid portal structure.
- Dynamics at the summit.
- Powerful 5-axis router head.
- Precision machining.



Chronos

Infiniti i settori di applicazione:



Arredamenti nautici, aeronautici, caravan
Interior furniture for ships, aircraft and caravan construction

Unlimited application fields:



Stampi
Models and moulds



Scale
Stairs



Sedie e mobili in stile
Chairs and period furniture



Termoformati e plastiche in genere
Thermoformed components and plastics of all types

Sempre la giusta configurazione Always the most suitable configuration

Chronos con piano fisso Chronos with fixed table

Lavorazione di un elemento per volta:

Per lavorare pezzi grandi
su tutto il piano.

Machining of a single component:

For machining large dimensioned
components on the entire table area.

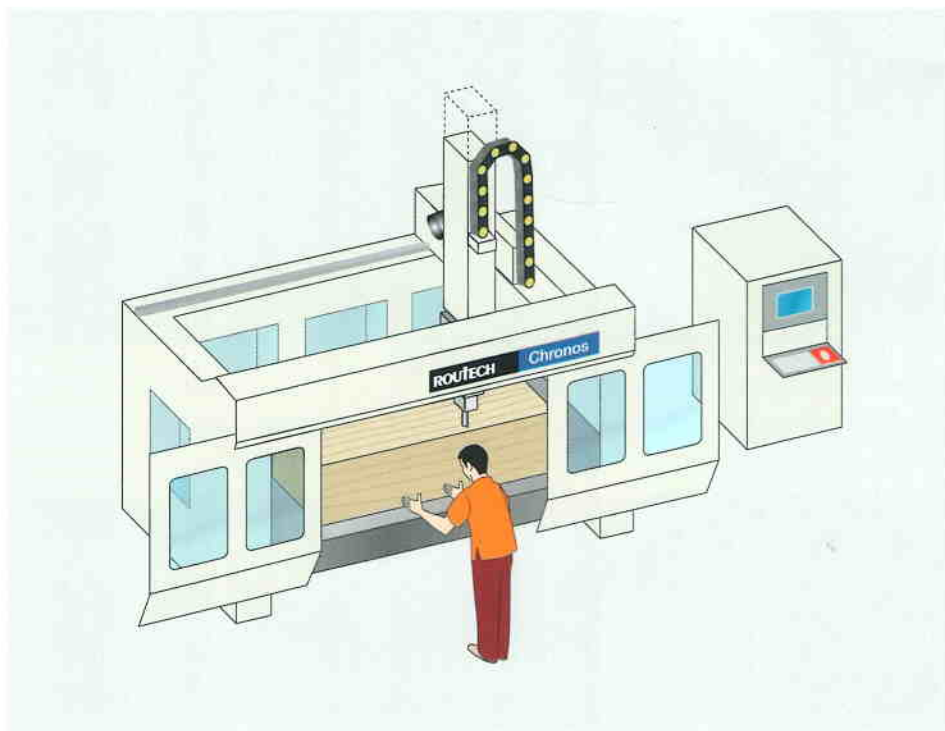

Lavorazione a pendolo:

Per lavorare pezzi piccoli su una metà
del piano, eliminando i tempi passivi
per scarico / carico.

Pendulum machining:

For machining small components on
one half table without down times for
unloading and loading.

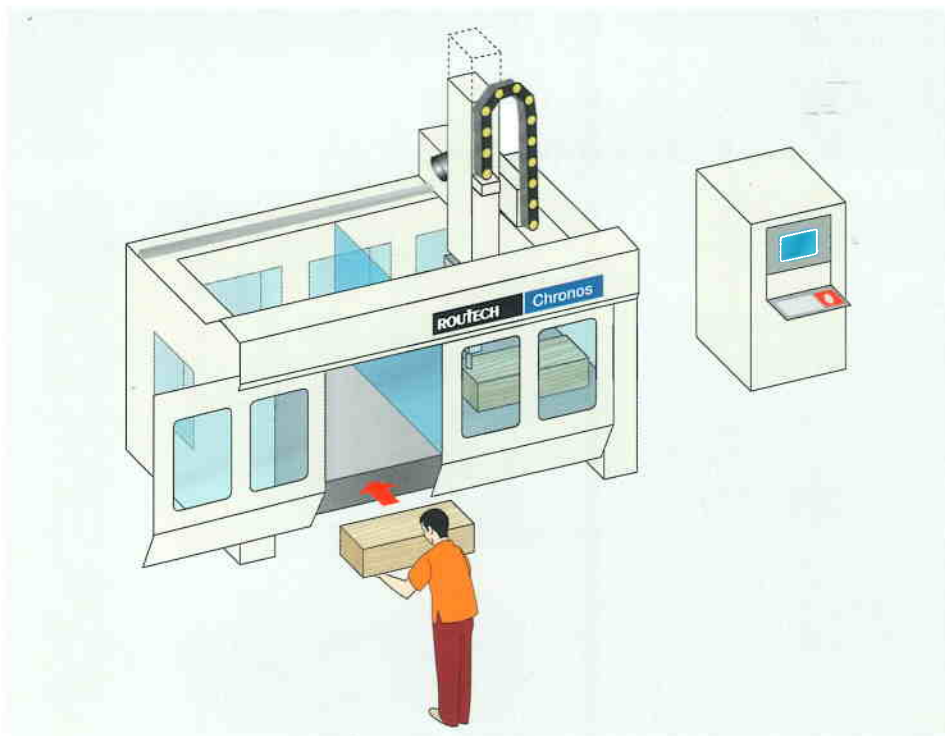

Chronos con piani mobili Chronos with mobile tables

Versione particolarmente idonea per l'impiego di caricatori automatici con prelievo dei pezzi da pallet

Version particularly suitable for the use of automatic feeders with pick-up of components from a pallet

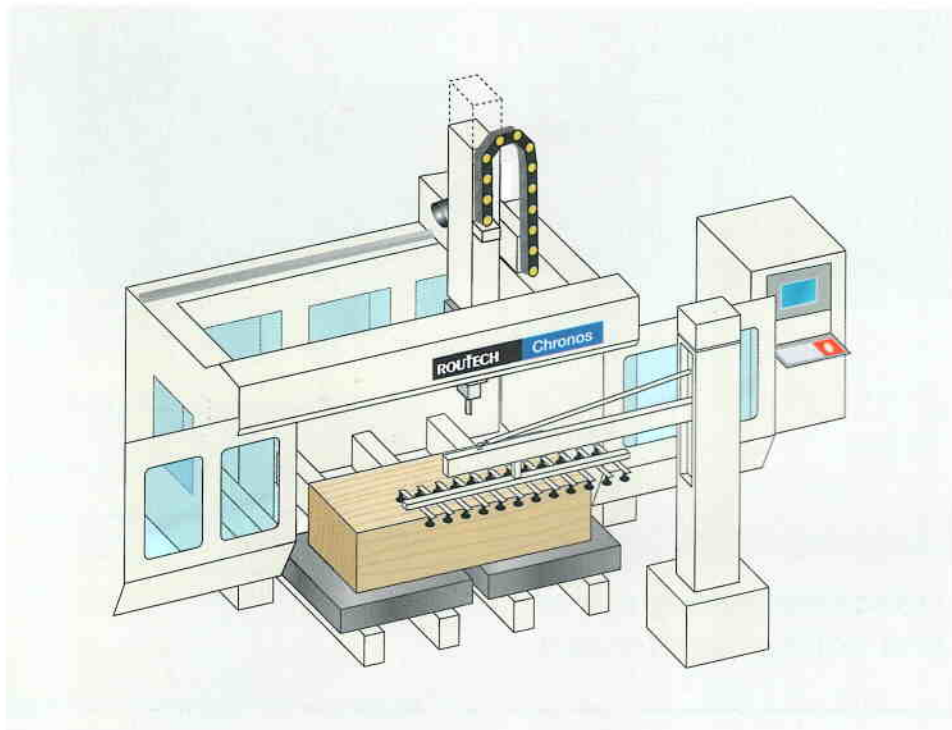

Lavorazione di un elemento per volta con piani mobili:

Piani sincronizzati con accesso da tre lati per lavorare pezzi grandi.

Machining of a single component on mobile tables:

Synchronised tables with access from 3 sides, for machining large components.

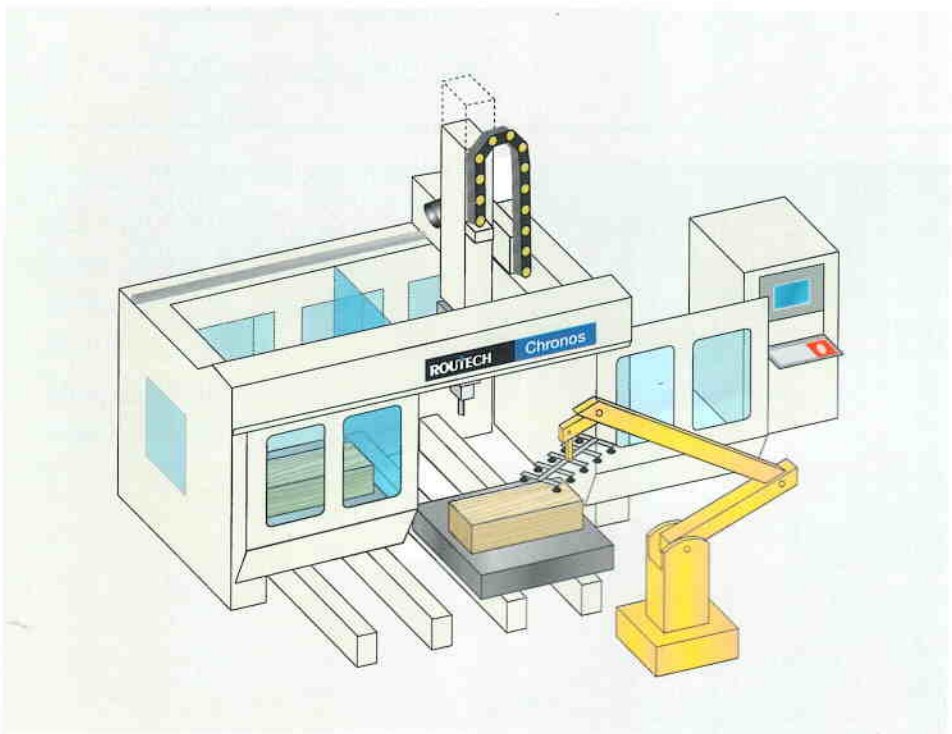

Lavorazione a pendolo con piani mobili:

Un piano chiuso all'interno della macchina, l'altro fuori ingombro, con accesso da due lati, per scarico/carico in tempo mascherato.

Pendulum machining with mobile tables:

One table closed inside during machining, the other table outside, with access from 2 sides, for unloading / loading in masked time.

Chronos. Nessun limite alle forme...
Chronos. Unlimited shapes...



Sempre la giusta unità operatrice

Always the most suitable routing unit

Gruppo operatore AVIO

AVIO routing unit

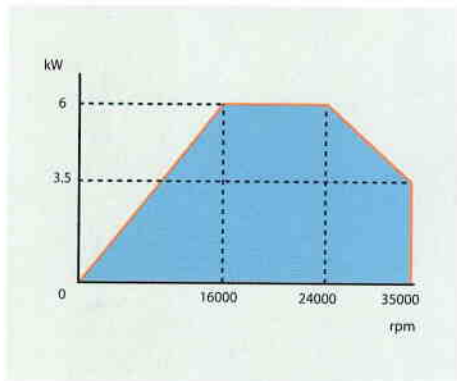

Potenza, alto numero di giri e dimensioni compatte: il gruppo operatore ideale per lavorazioni su plastiche e leghe leggere.

High rotation speed, powerful and compact: the perfect routing head for machining plastics and light metals.



Per la massima velocità d'esecuzione

For high-speed machining

I magazzini utensili

The tool magazines

- **Varie soluzioni adatte ad ogni esigenza.**
- **Esecuzione di profili differenti in un unico ciclo di lavoro.**
- **Disponibilità di 6 o 12 utensili sempre pronti.**
- **Different solutions for any requirement.**
- **Execution of different profiles in a single work cycle.**
- **6 or 12 tools always ready on the machine.**

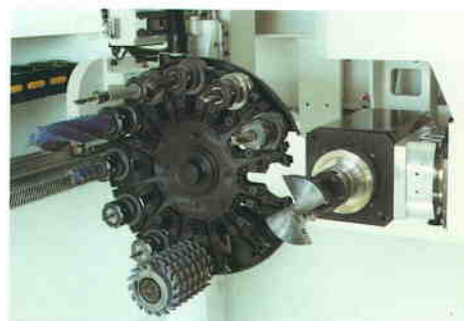

Gruppo operatore AVIO M AVIO M routing unit



**Potenza, precisione
e qualità di finitura**

**Utmost accuracy
and finish**

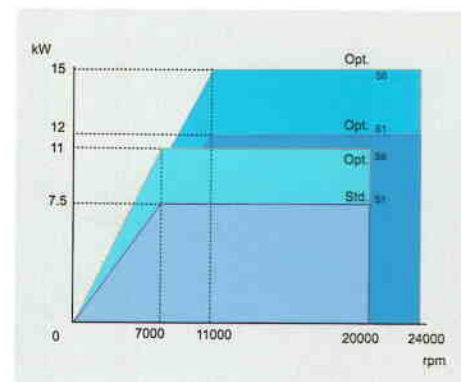

Potenza e rigidità per le migliori finiture: il gruppo studiato per le esigenze di fresatura a 5 assi su legno.

Powerful and rigid: the perfect routing head for high quality machining of wooden components.



Possibilità di un magazzino supplementare con ulteriori 24 utensili.

Possibility to fit an additional 24 position tool magazine.

...tutta la flessibilità dei 5 assi ...the complete flexibility of 5 axes

- Impiego universale.
- Ampii angoli di rotazione.
- Massima libertà di movimento.
- Universal application.
- Wide rotational range
- Free and unlimited movement.

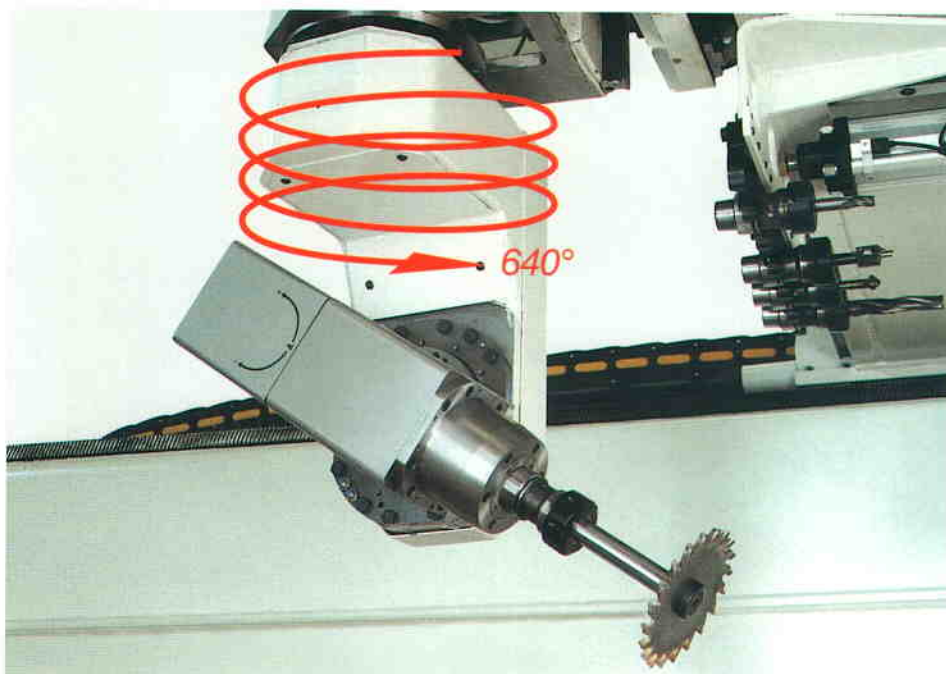

Rotazione asse verticale C:
fino a 640°

Rotation of vertical axis C:
up to 640°

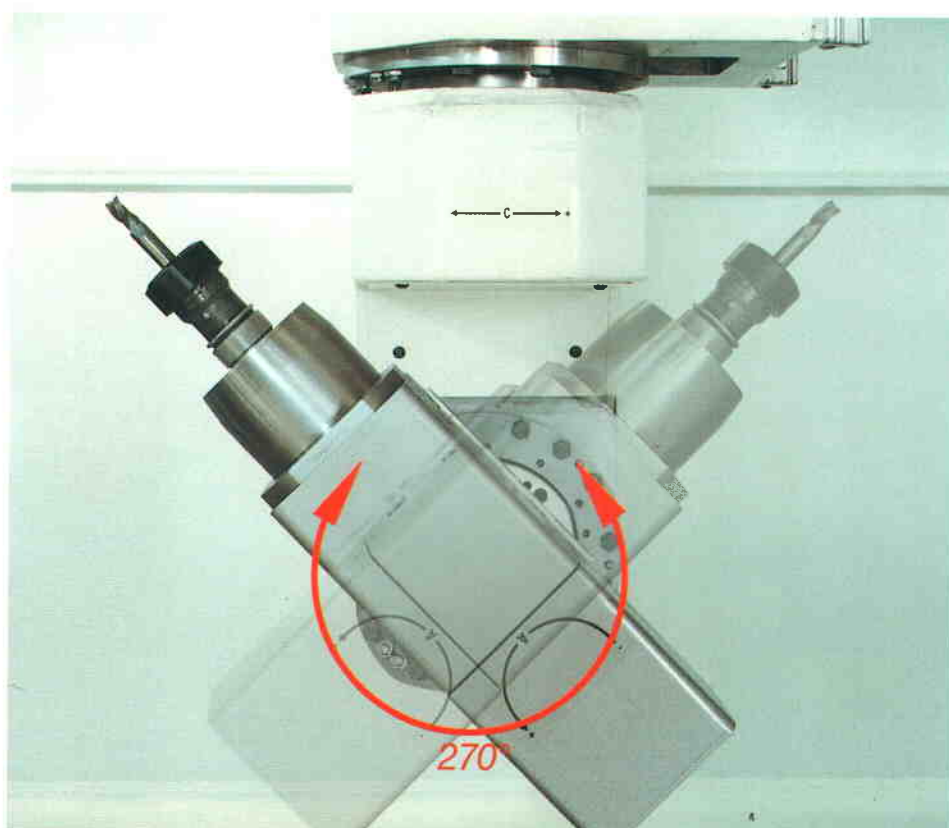

Rotazione asse orizzontale A:
fino a 270°

Rotation of horizontal axis A:
up to 270°

Sempre il giusto piano di lavoro Always the most suitable worktable

Diverse soluzioni con una vasta gamma di accessori per ogni applicazione ed ogni esigenza di fissaggio diretto di pezzi, sottopiezi o attrezzature.

Piano multifunzionale in alluminio

Versatilità oltre ogni limite.

Different solutions with a wide range of accessories for any application and any requirement with direct fixing of components, jigs or clamping equipment.

Multipurpose aluminium table

Unlimited versatility.

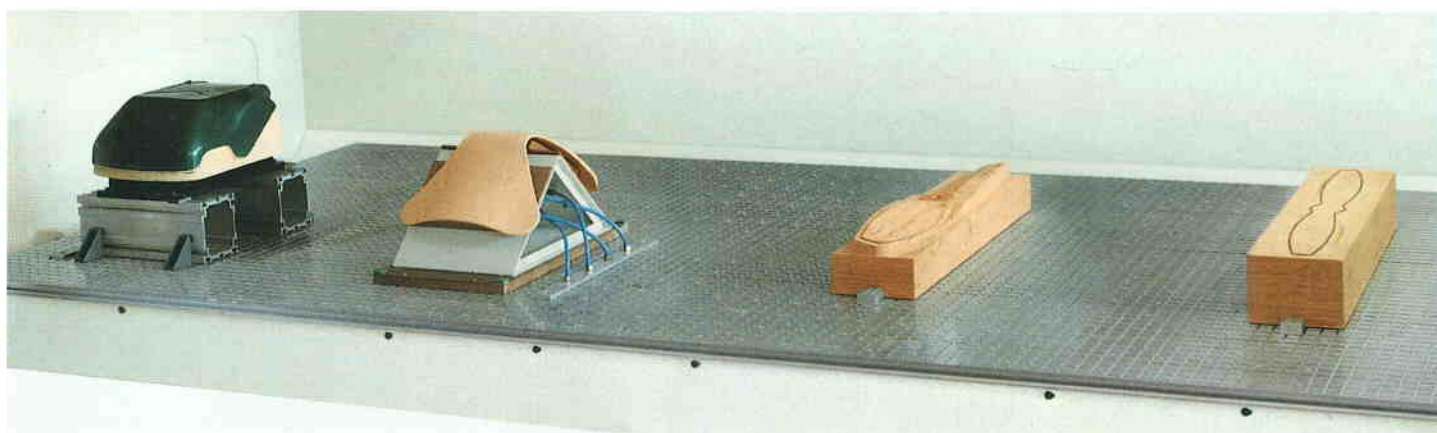

Per il fissaggio di pezzi di qualsiasi genere e attrezzaggi per forme complesse.

For fixing all types of components and clamping equipment for complex shapes.

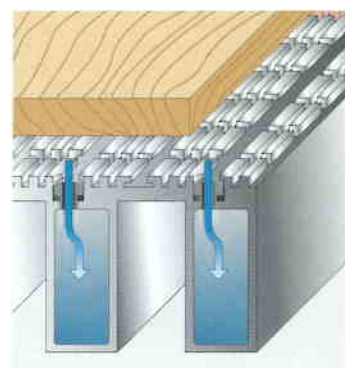
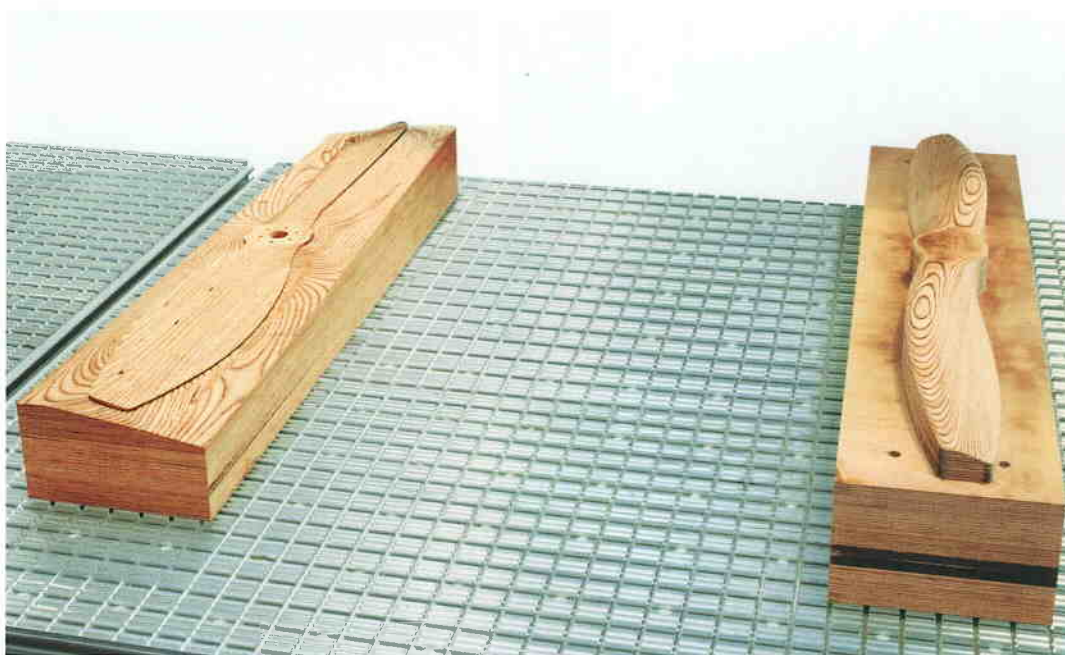

Piano a barre fisse

Particolarmente adatto per lavorazioni con grandi sfridi che possono cadere tra le barre nei cassetti di raccolta sotto il piano.



Un pratico ancoraggio per attrezzature e sottopiezi.

Table with fixed bars

Particularly suitable for machining components with large waste removal which can fall down between the bars in the collection drawers underneath the table.



Practical fixing of jigs and clamping devices.

Piano TVN a barre mobili con ventose

Velocità nei cambi di lavorazione.

TVN table with mobile bars and vacuum pods

Fast set-up.



Pratiche barre rapidamente regolabili con sistema a vuoto senza tubi con possibilità di aggiungere ventose supplementari, nonché morsetti pneumatici per un bloccaggio sicuro anche con grosse asportazioni.

Practical bars with fast adjustment and tubeless vacuum system, enabling the fitting of additional vacuum pods and pneumatic clamps for a positive fixing of components even with heavy stock removal.



Sicurezza, ergonomia e rispetto dell'ambiente di lavoro Safety and ergonomics with respect for the environment

- **Drastica riduzione di polvere e rumorosità.**
- **Zona operatore senza pericoli.**
- **Facile osservazione delle lavorazioni.**
- **Drastic reduction of dust and noise.**
- **Operator area free from danger.**
- **Easy survey of machining operations.**



Paratia in polycarbonato per le lavorazioni a pendolo.



Central polycarbonate safety shield for pendulum machining.

In versione con piano a barre fisse:
ampi cassetti estraibili per la raccolta di trucioli e sfridi.

In the version with fixed table bars:
large extractable waste collection drawers.



Sempre il giusto sistema di auto-apprendimento

Always the most suitable teach-in system

- L'esperienza Routech al vostro servizio.
- Generazione programmi senza CAD/CAM.
- Programmi pronti per l'esecuzione in macchina.
- Routech's experience at your service.
- Program generation without CAD/CAM.
- Programs ready to be executed on the machine.

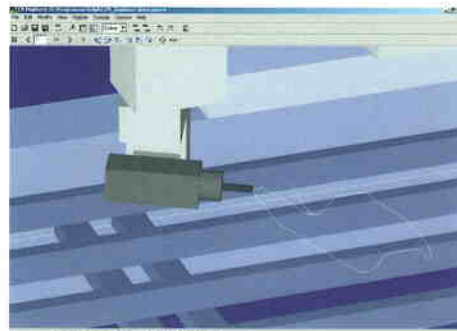
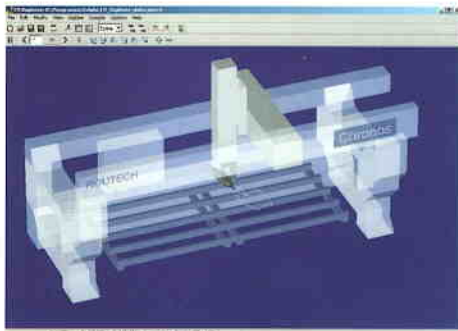

Software per simulazione grafica 3D in real time con possibilità di rilevare errori di acquisizione o verificare eventuali collisioni.

Software for graphic 3D simulation in real time allowing the checking of tracing errors or the risk of collision.



< Genesis

Sistema a bordo macchina per l'acquisizione di punti geometrici tramite il posizionamento dell'unità operatrice.

Teach-in system on the machine, tracing the component geometry with the direct positioning of the head unit.



^ Genesis Desk

Digitalizzatore a braccio da tavolo per pezzi di piccole e medie dimensioni.

Digitizer with mobile arm for use on a desk, suitable for small and medium sized components.



< Genesis Station

Stazione di auto-apprendimento per pezzi di grandi dimensioni, con banco e digitalizzatore a braccio dall'alto.

Teach-in station for large dimensioned components, including bench and overhanging digitizer with mobile arm.

Alta tecnologia come garanzia di precisione
Modern manufacturing techniques giving a guarantee of precision

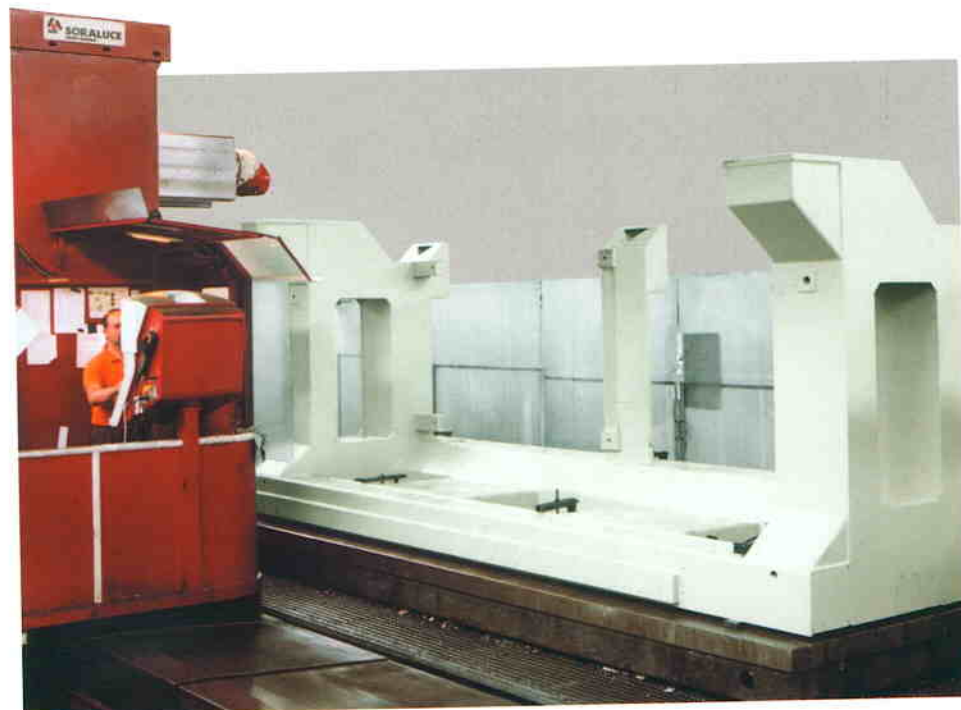

La flessibilità di un costruttore specializzato
The flexibility of a specialised manufacturer



Struttura a portale con traversa mobile Portal construction with mobile cross beam

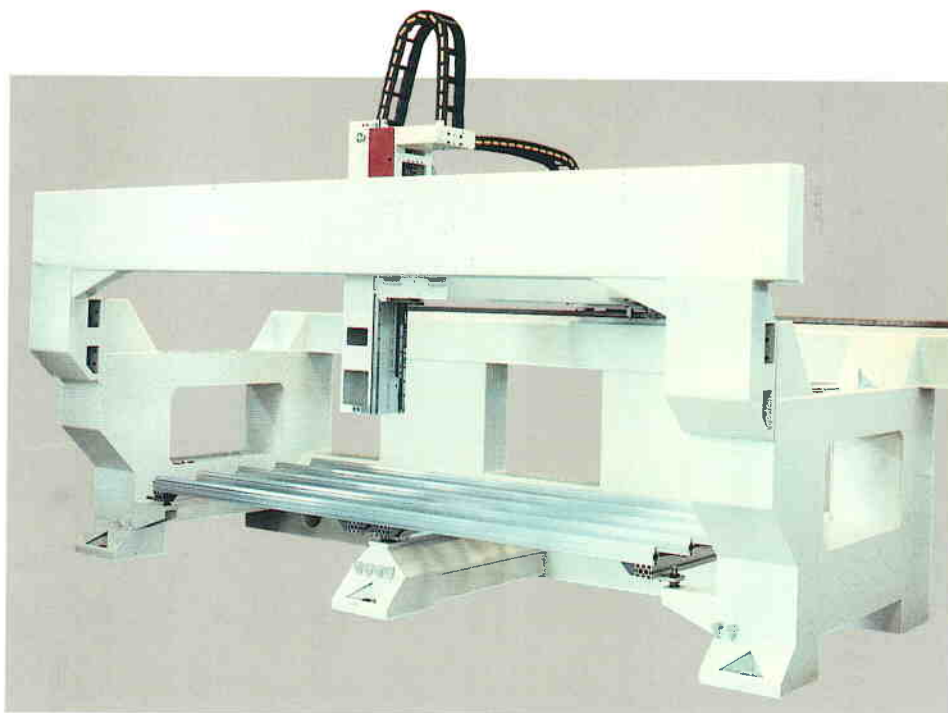

- Massima rigidezza e precisione.
- Massima rapidità d'esecuzione e qualità dei lavorati.

- Highest rigidity and the greatest machining accuracy.
- High-speed machining and superb finishing.

Movimentazione assi Axis traverse



Trasmissione Z
Transmission Z



Trasmissione Y
Transmission Y

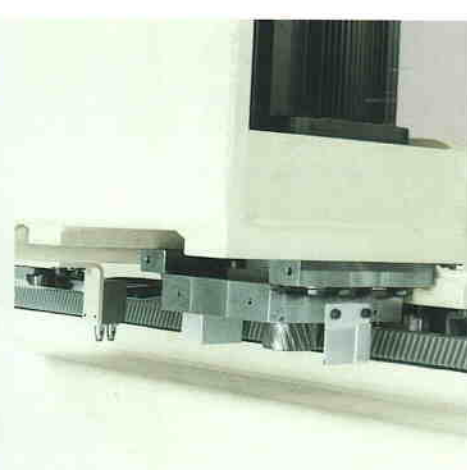

Trasmissione X
Transmission X

- Guide prismatiche con pattini a ricircolo di sfere per la massima precisione e rigidità dinamica.
- Pignone e cremagliera di precisione con recupero di giochi per gli assi X, Y e Z (130 m/min).

- Prismatic guide-ways with recirculating ball slides ensuring the highest accuracy and dynamic rigidity.
- Rack and pinion with backlash recovery for the axes X, Y and Z (130 m/min).

Le massime prestazioni nel minimo spazio Highest performance in the smallest space

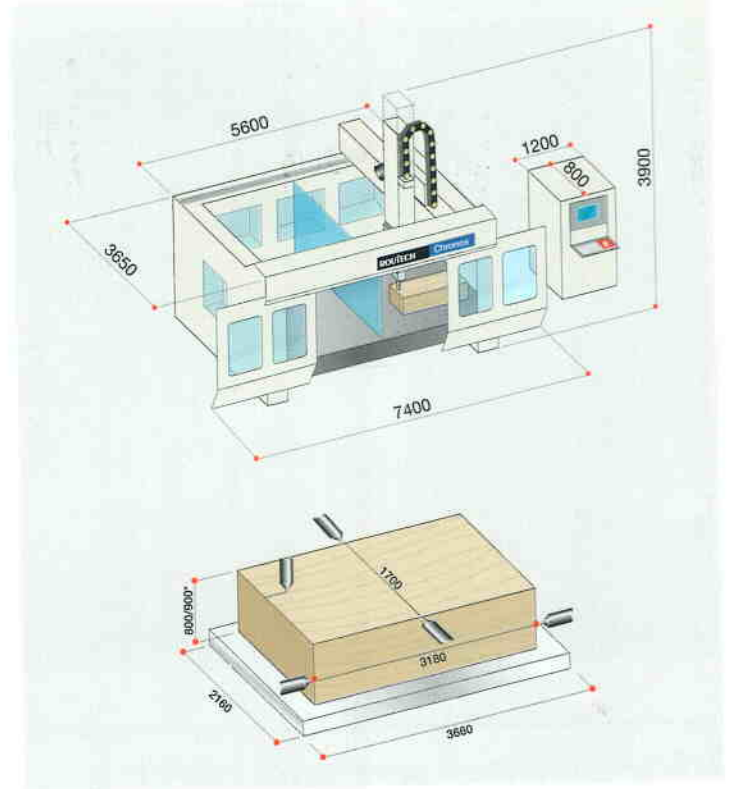
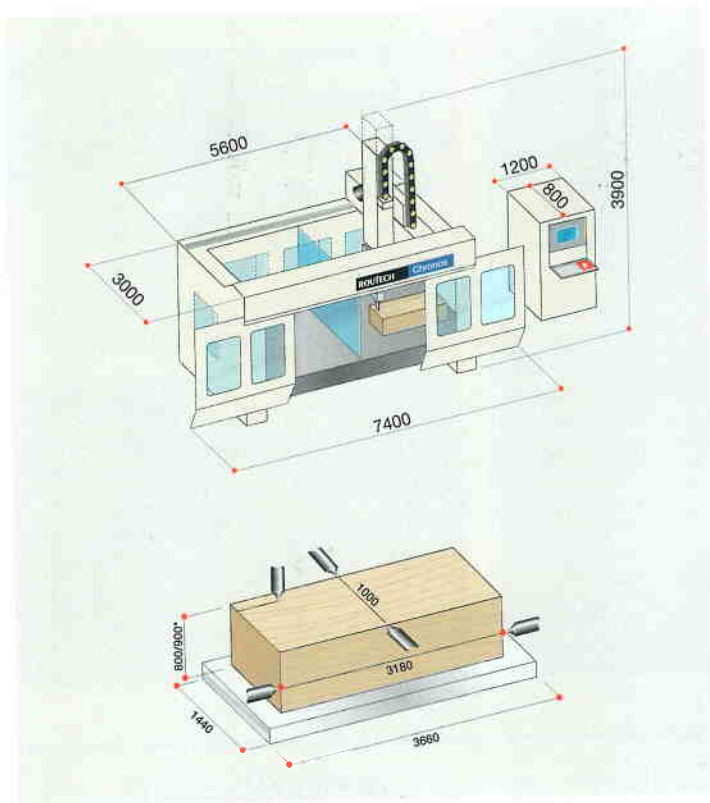

- (*) Passaggio pezzo con Rapid 12
- (*) Component loading height with Rapid 12

Dati tecnici Technical data

Corse assi	3700 (5100 opz.) x 1550 (2200 opz.) x 1000 mm
Trasmissione assi X-Y-Z	Pignone e cremagliera di precisione
Velocità assi X-Y-Z	130 m/min
Rotazione asse C	0°-640°
Rotazione asse A	±135°
Gruppo operatore AVIO	
Regime di funzionamento	1500-35000 g/min
Potenza elettromandrino	6 kW a 16000 g/min 4,3 kW a 35000 g/min
Gruppo operatore AVIO M	
Regime di funzionamento	900-20000 g/min
Potenza elettromandrino standard	7,5 kW a 7000 g/min
Unità di governo	CNC + PC Office

Per esigenze dimostrative alcune foto riproducono macchine complete di accessori opzionali.
Routech si riserva il diritto di modificare i dati tecnici e le dimensioni.
Le modifiche non influenzano le condizioni di sicurezza nell'utilizzo della macchina.

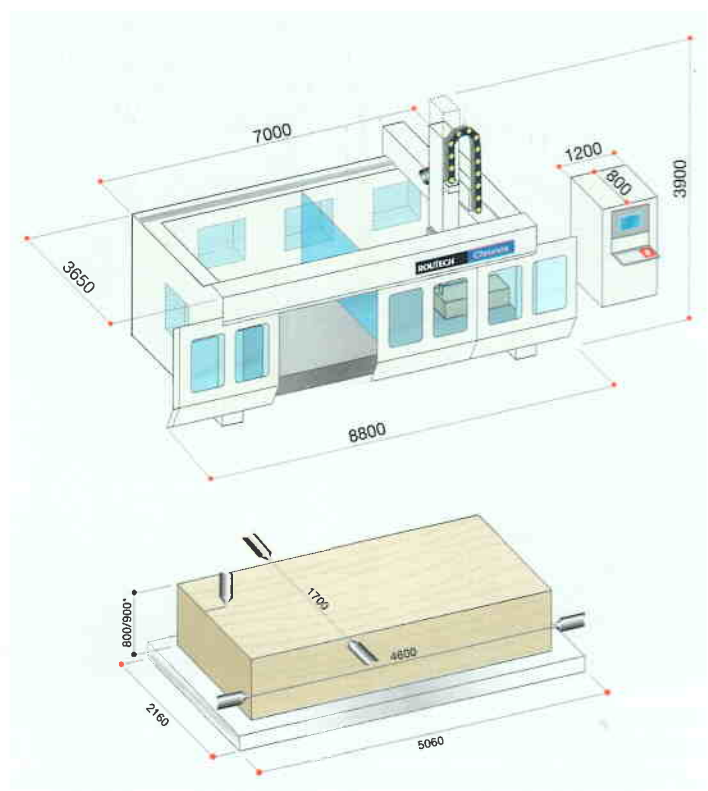
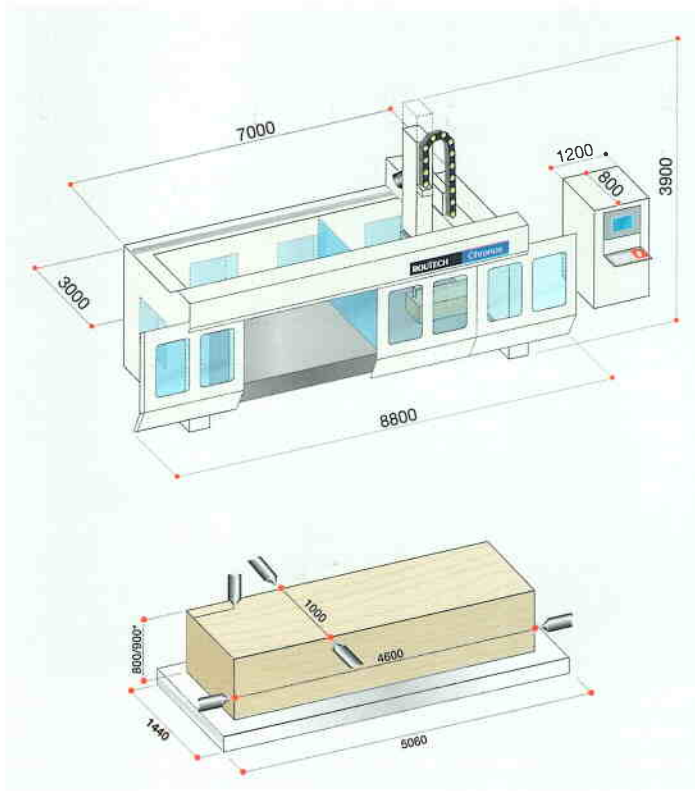

Axis stroke	3700 (5100 opt.) x 1550 (2200 opt.) x 1000 mm
Axis transmission X-Y-Z	Precision rack and pinion
Axis speed X-Y-Z	130 m/min
C axis rotation	0°-640°
A axis rotation	±135°

AVIO routing unit

Electro-spindle rotation range	1500-35000 rpm
Electro-spindle motor power	6 kW at 16000 rpm 4,3 kW at 35000 rpm

AVIO M routing unit

Electro-spindle rotation range	900-20000 rpm
Electro-spindle motor power standard	7,5 kW at 7000 rpm
Control unit	CNC + Office PC

In this catalogue, some machines are shown with options.
Routech reserves the right to modify technical specifications and measures.
Such modifications do not affect safety in the use of machine.

Rotech. Tecnologie che segnano il tempo Milestones in technology

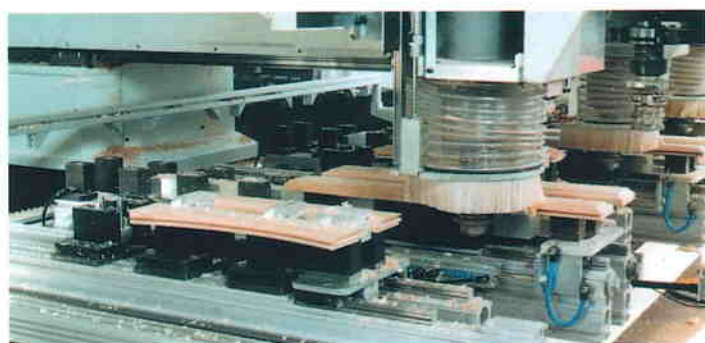
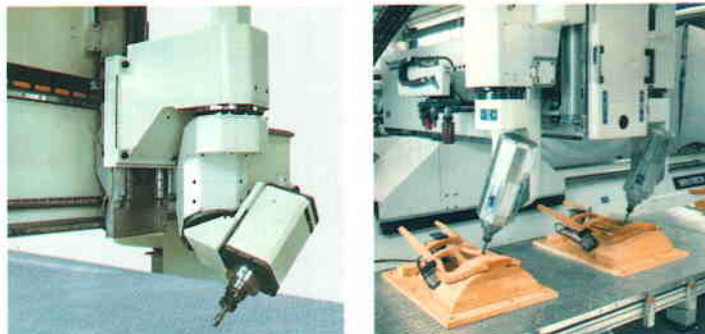

Rotech progetta e produce centri di lavoro industriali a CNC; macchine che offrono un contributo importante all'evoluzione dei processi di produzione e che sono destinate alle industrie più esigenti; una scelta decisa che non lascia spazio a compromessi nelle scelte progettuali, nella definizione dei processi di lavorazione, nella selezione dei componenti, nel controllo rigoroso della qualità e nella garanzia di un adeguato livello di servizio.

L'alta tecnologia Rotech poggia su fondamenta solide: una superiore qualità meccanica e unità di governo di primo livello, potenti e moderne, facili da programmare, predisposte all'integrazione delle fabbriche e aperte al dialogo con i più avanzati sistemi informatici, per fornire alla moderna industria del legno soluzioni d'avanguardia e accompagnarla con successo nel terzo millennio, con **tecnologie che segnano il tempo**.

Rotech designs and produces CNC work centres for industrial use: machines which make an important contribution towards the evolution of the production processes and which are destined to the most exigent industries. A firm choice which leaves no space for compromising during the determination of the project, the machining process, the selection of components, a rigorous quality control and the guarantee of adequate servicing. Rotech's high technology has a solid basis: highest mechanical quality and first class control units, powerful and modern, with easy programming and pre-arranged for integration in the factories, suitable to dialogue with the most advanced data processing systems, so as to offer innovative solutions to the modern woodworking industries and to lead them through the third millennium with **milestones in technology**.



ROUTECH

Scm Group. Da cinquant'anni al servizio dell'industria del legno Serving the woodworking industry for 50 years



Due milioni di macchine installate in oltre 120 paesi, 3000 dipendenti, 18 stabilimenti, 23 filiali ed una percentuale di esportazione che supera il 70%. Il Gruppo opera attraverso una serie di marchi prestigiosi: SCM, azienda "storica" del Gruppo con una gamma completa di macchine per la lavorazione del massiccio e del pannello destinate alla piccola e media azienda; MORBIDELLI, macchine e sistemi di foratura, GABBIANI, sistemi di sezionatura; DMC, macchine e linee di levigatura, IDM e STEFANI, bordatrici, squadrabordatrici e linee di squadrabordatura; ROUTECH, centri di lavoro ad elevata produttività; SCM Group Engineering, sistemi integrati per l'industria del legno; MAHROS, sistemi automatici di movimentazione; MINIMAX con una gamma completa per il laboratorio artigianale. Ad integrare il processo produttivo, due fonderie, per la produzione di getti in ghisa, uno stabilimento ad alta automazione per la produzione di componenti elettrici ed elettronici ed una divisione ricerca e sviluppo. I prodotti del Gruppo vengono distribuiti in tutto il mondo attraverso filiali presenti attualmente in Germania, Francia, Spagna, Gran Bretagna, Olanda, Belgio, Romania, Polonia, Russia, Canada, USA, Messico, Brasile, Singapore, Cina e da una rete di 350 agenti e concessionari.

Two million machines operating in over 120 countries, 3.000 employees, 18 factories, 23 subsidiaries and an export rate which accounts for 70% of its production. SCM GROUP operates through a number of highly prestigious brands: SCM, the founder company which produces solid wood and panel processing machinery for the small and medium companies; MORBIDELLI, boring machines and systems; GABBIANI, panel sizing machines and systems; DMC, sanding machines and systems; STEFANI and IDM, edgbanding and squaring machines and systems; ROUTECH, CNC routers and machining centres for industrial use; SCM GROUP ENGINEERING, integrated systems for woodworking; MAHROS, handling machines; MINIMAX, workshop woodworking machinery. The production process is completely integrated with two foundries for cast iron, a dedicated and highly automated factory for the production of electric and electronic components and a study & research division. SCM Group products are distributed worldwide through subsidiaries operating in Germany, France, Spain, Great Britain, Netherlands, Belgium, Romania, Poland, Russia, Canada, United States, Mexico, Brazil, Singapore, China and through a qualified network of 350 agents and distributors.

scm e group

ROUTECH



00005553896



ROUTECH

SCM GROUP spa - Routech - Via Emilia, 77 - 47900 Rimini - Italy
Tel. ++39/0541/700470 - Fax ++39/0541/700293 - www.scmgroup.com - E-mail: routech@scmgroup.com