

RECORD 220

CNC

machining centres

 **scm**

RECORD 220

Reasons for success

The RECORD 220 has been designed for today's woodworking companies who want to meet tomorrow's production challenges; to go beyond the today's routers and borers to the **real universal, modern machining centre**: powerful and fast, heavy routing, drilling and cutting performance **with high productivity** even on small batches.

Designed by the latest computer technology, RECORD 220 has the **strongest structure** to enable heavy and complex routing and machining. Ensuring a **high quality finish** even under heavy load.

RECORD 220 is equipped with SCM-designed electro-spindles (10 or 15 HP) able to guarantee the necessary power required under extreme working conditions.

Difficult routing operations requiring several passes are completed quickly with high productivity due to the tool magazine positioned close to the main head.

Drilling, routing and all other operations are completed with the highest quality and speed because machining heads have been designed for intensive work.

Selected machining heads are driven by powerful brushless motors controlled by CNC unit. Highly flexible interpolating capabilities of this CNC unit ensure accuracy and absence of vibration.

The CNC unit is easy to program and the options are almost limitless; the operator-machine dialogue is simple and immediate. There are no limits to **what** you can do and **how** you do it.

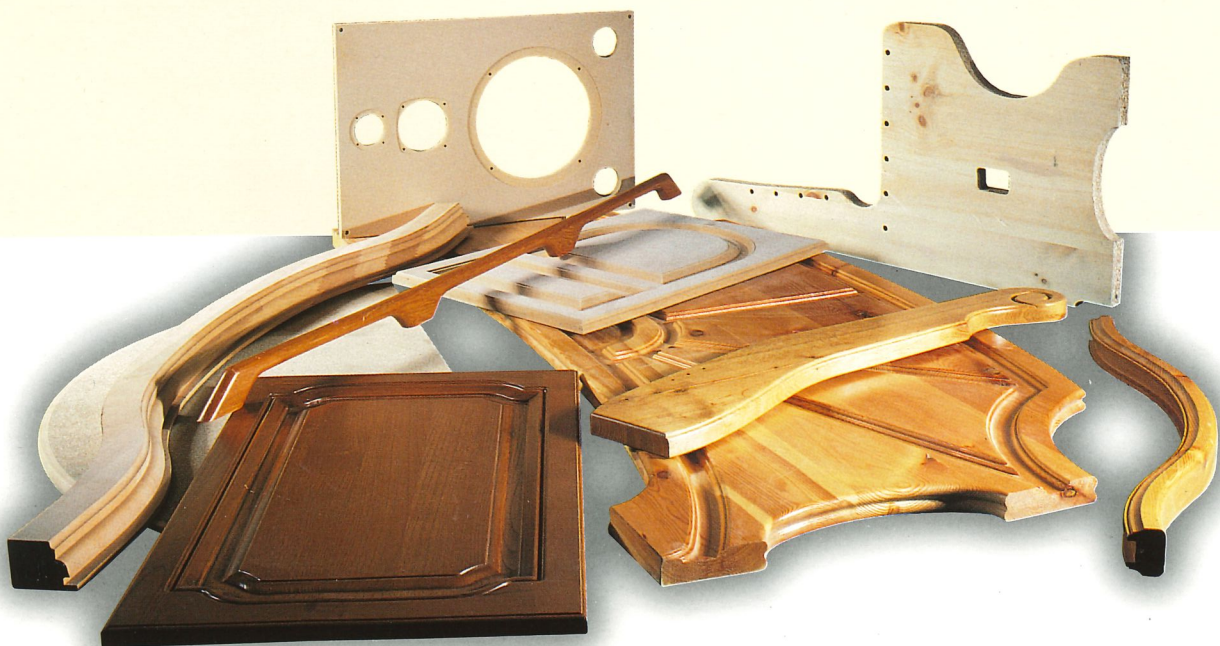
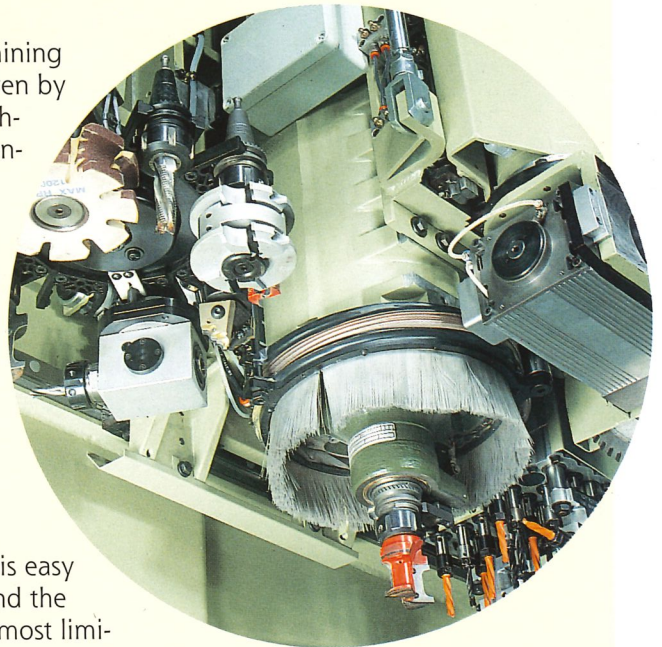

RECORD 220

Universal use

The exclusive, multi-purpose worktable will take any component in all positions with ease and safety due to a versatile clamping system:

- direct vacuum hold-down for routing on the component top surface
- vacuum hold-down for through routing. No need for jigs.
- vacuum hold-down with suction cups for special routing operations
- mechanical and pneumatic hold-down for complex routing on narrow or very thick components.



Vacuum is available on the full surface through specific channels within the worktable. Rubber sealing gaskets can be inserted into worktable grooves to enable any component shape to be held.

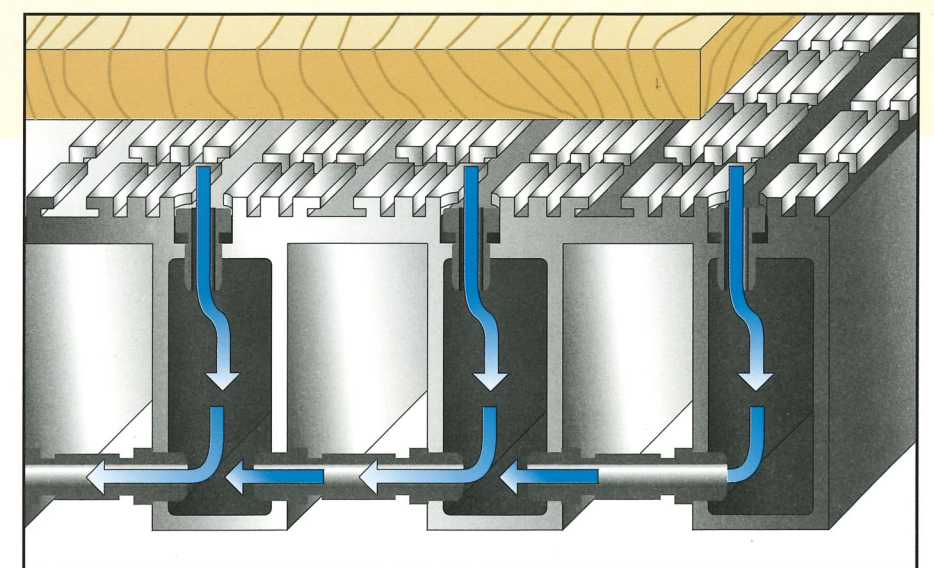

Multi-purpose worktable

An answer for any clamping requirement

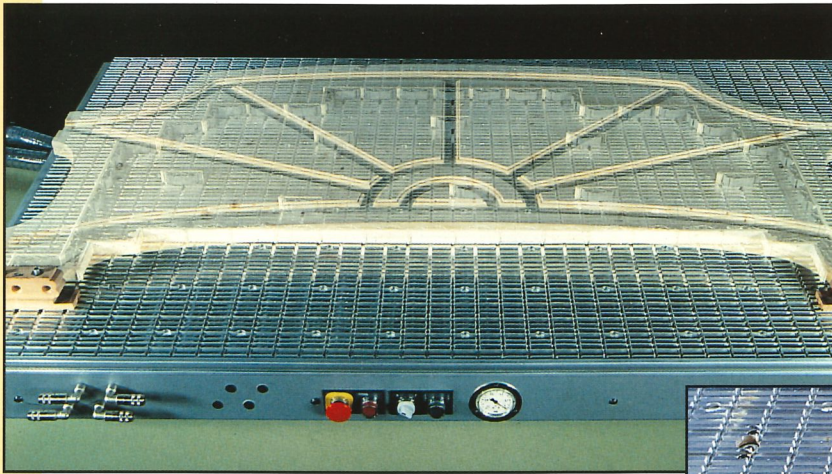

The component can be raised from the table and held down by "MODULSET": a set of modules which can be inserted in the worktable grooves to quickly and accurately copy the component shape. **Jigs are no longer required.**

As an alternative to the "MODULSET", suction cups can be fitted in almost any position on the worktable. Vacuum directly reaches the component without the need of hoses or tubes.

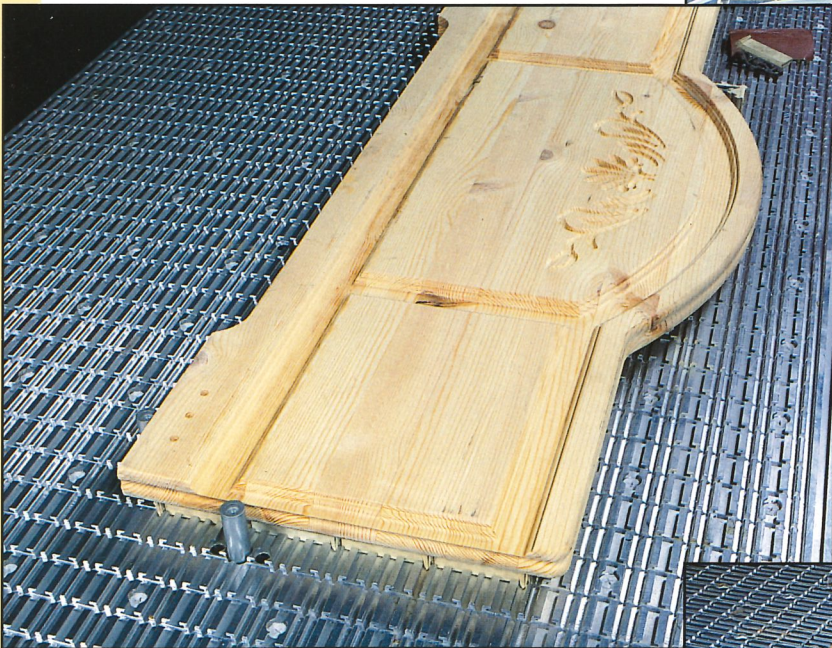
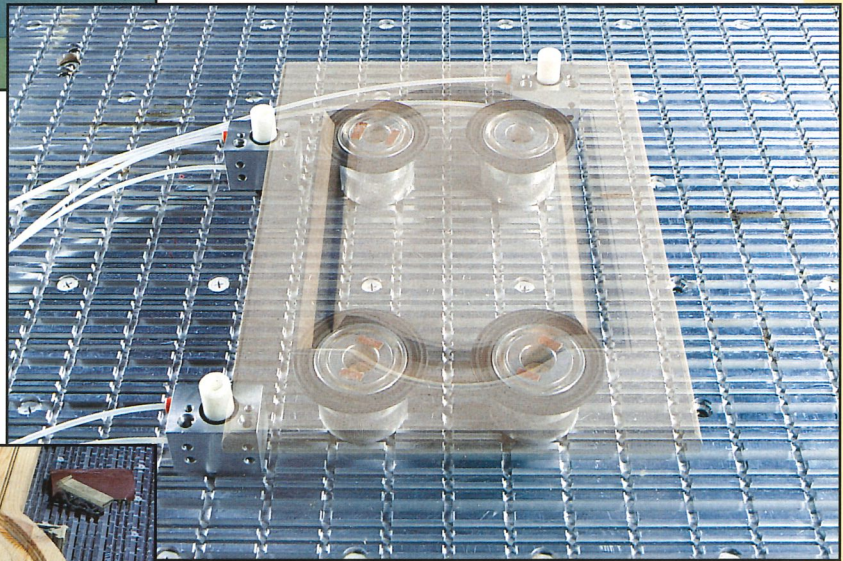

For complex jobs on narrow or very thick components, a jig can easily be fitted to the table; fittings and connections are also provided for pneumatic hold-down cylinders.

CNC-controlled, retractable pneumatic stops guarantee precise positioning.

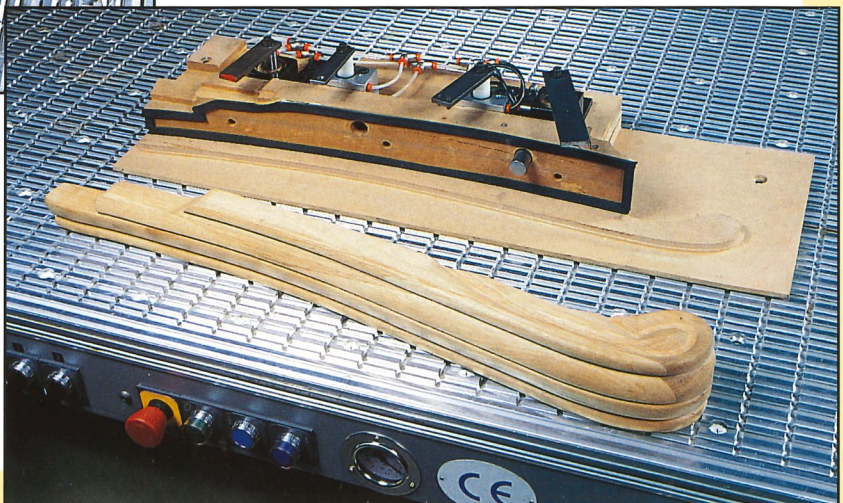

RECORD 220 TVS

Fastest changeover from one job to the other

The suction cups can rapidly be positioned on TVS (tubeless vacuum system) worktable. This means: **flexibility and low tooling times.**

The machine combines the capability to handle a large variety of shapes and sizes with the capability to handle small batches economically.

- The rapid, simple and safe suction cups' positioning easily **matches any component shape.**
- Through routing can be carried out with the component clamped by the suction cups without any tubes or hoses.

- Maximum rigidity and accuracy are guaranteed by a robust suction cup-bar unit running on prism guides with recirculating ball screws.

- A power-driven conveyor ensures the constant removal of waste material from worktable.

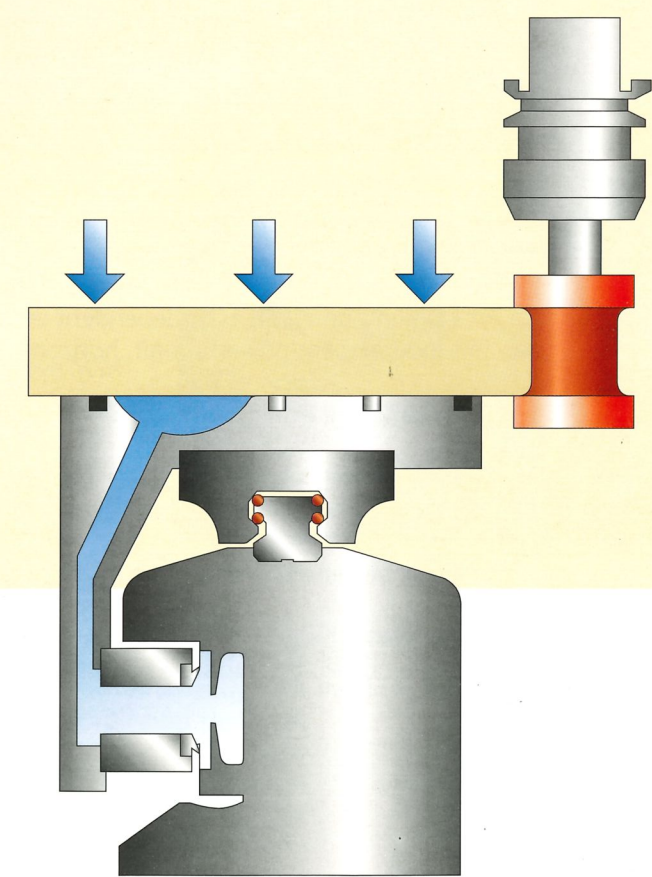
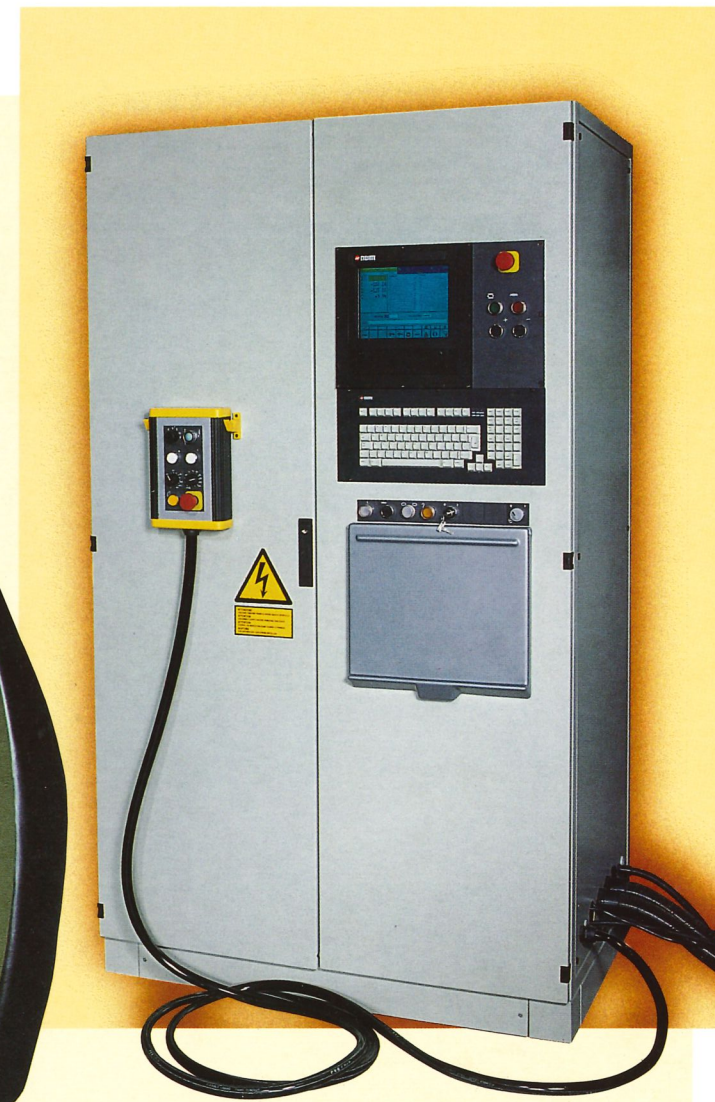
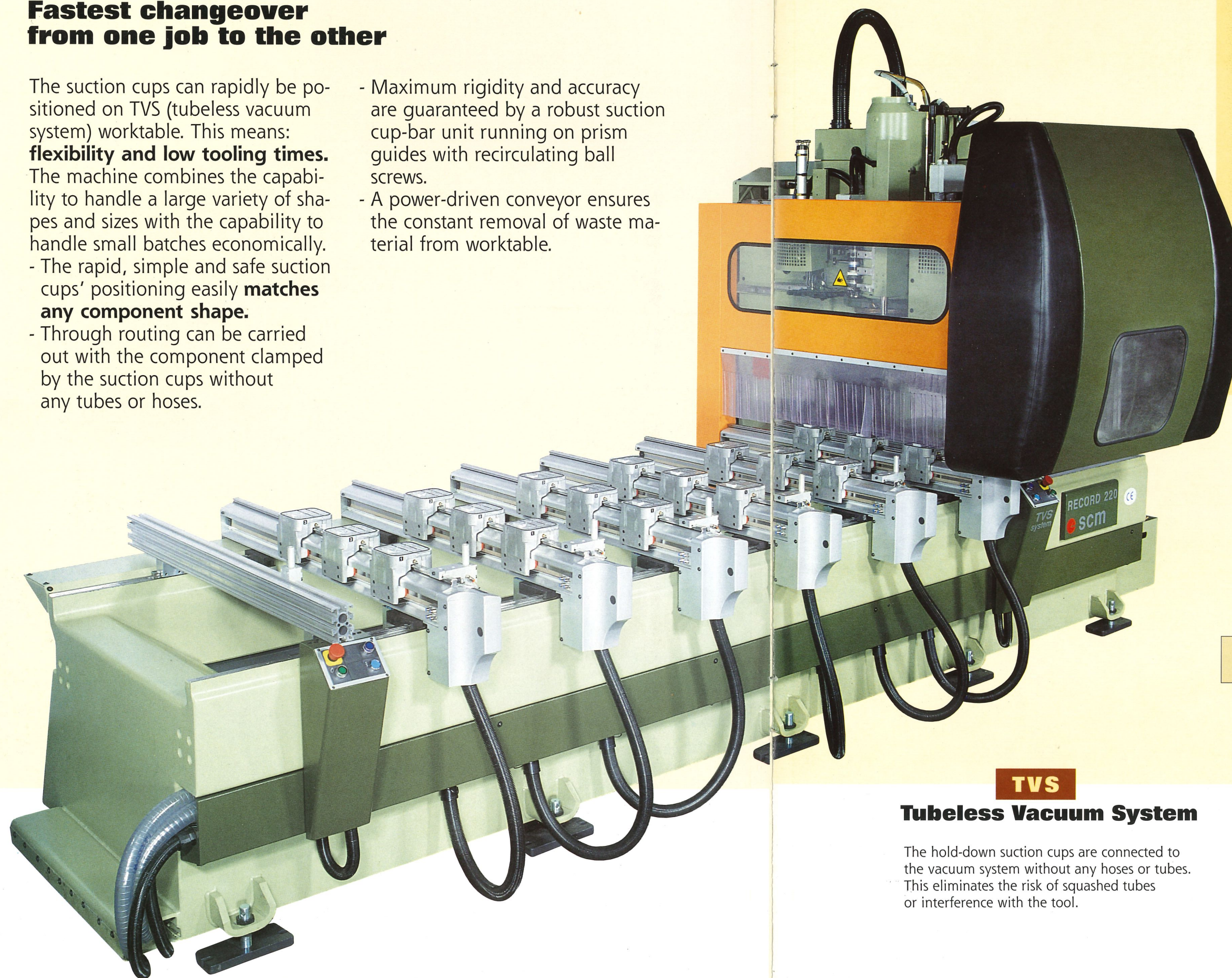

TVS

Tubeless Vacuum System

The hold-down suction cups are connected to the vacuum system without any hoses or tubes. This eliminates the risk of squashed tubes or interference with the tool.

TVS

Leading edge technology

CNC-controlled retractable pneumatic stops for precise components' reference.

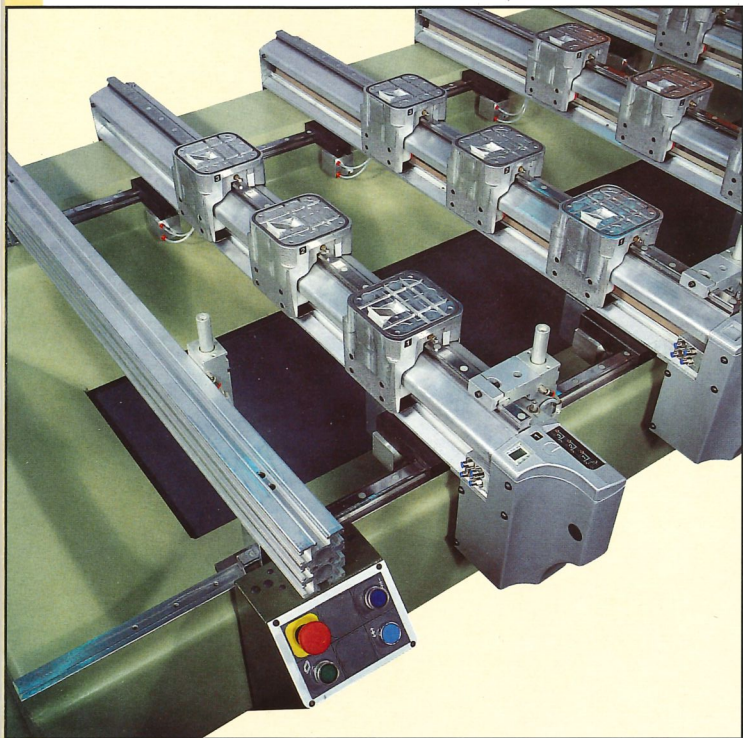

High quality and precision finish are guaranteed by the strong bars and suction cup units running on prism guides with recirculating ball screws.

Example of through-routing with component clamped directly by the suction cups.

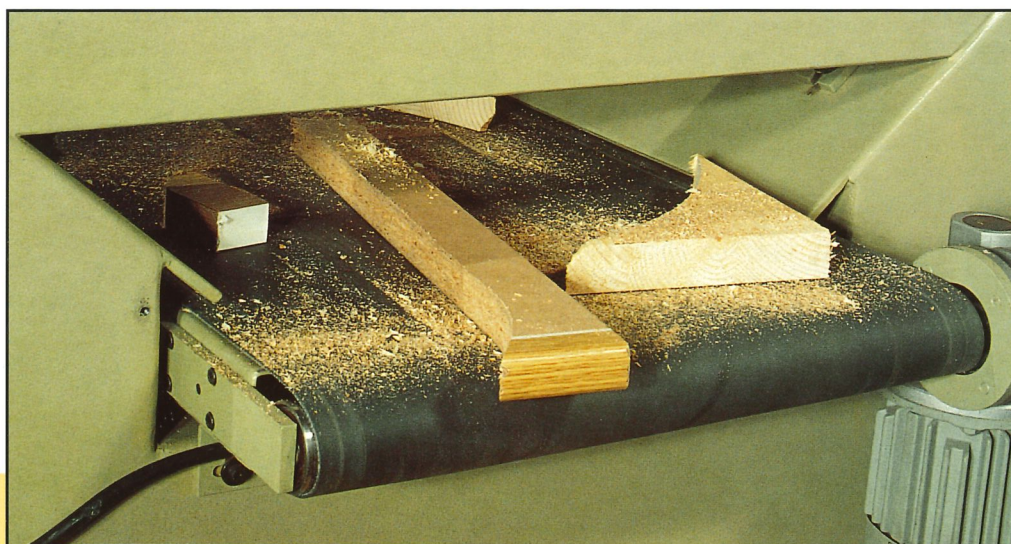
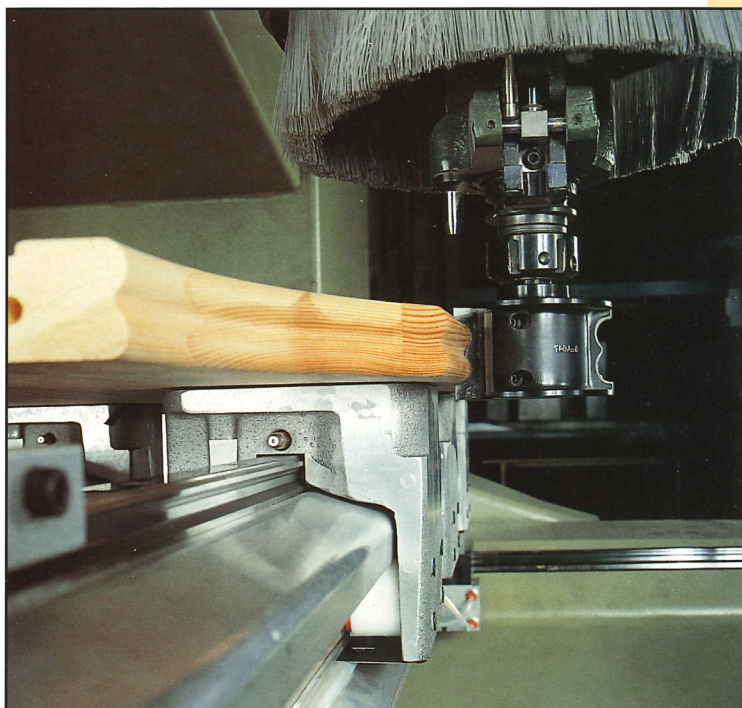

Power-driven waste conveyor ensures maximum cleanliness.

AUTOSET

Processing changeover in record time

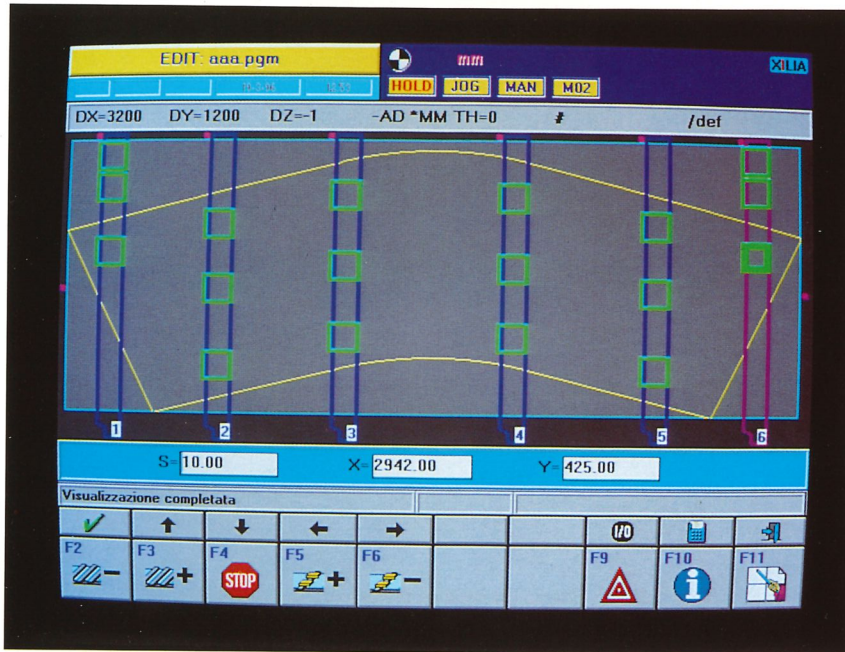

Guided by the CNC unit, it takes only 2 minutes to changeover from one operation to another.

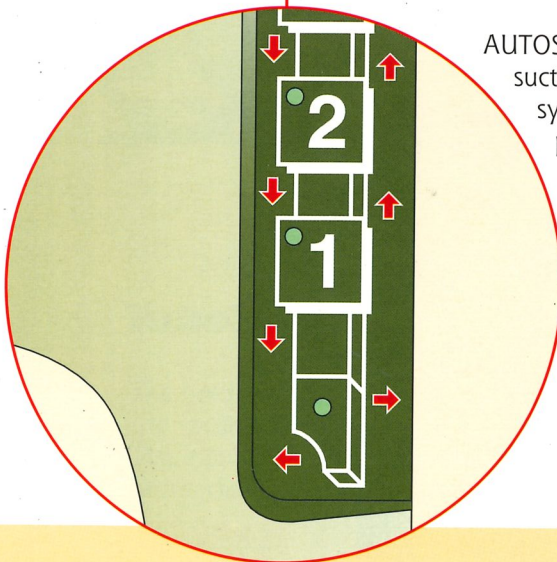
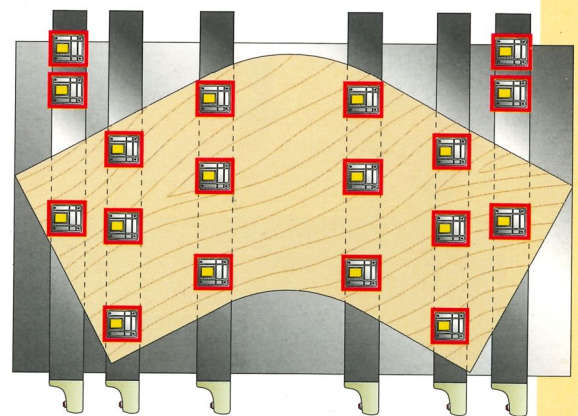
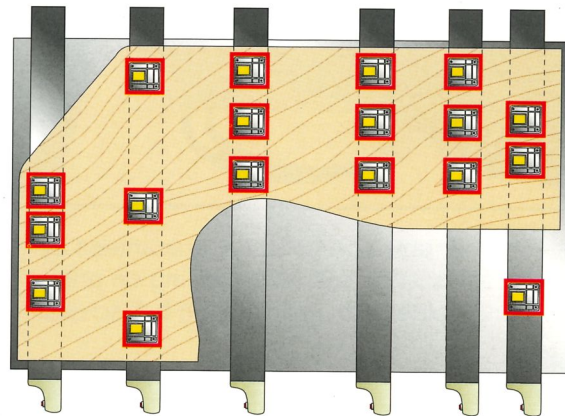

AUTOSET is the exclusive SCM suction cup rapid positioning system which makes the processing of small batches and single pieces an economical production.

The CNC informs the operator about the exact position of the suction cups according to the specific workpiece program: **the suction cups automatically lock in place when they reach the established position.**

Machining units

The ideal answers to all machining needs

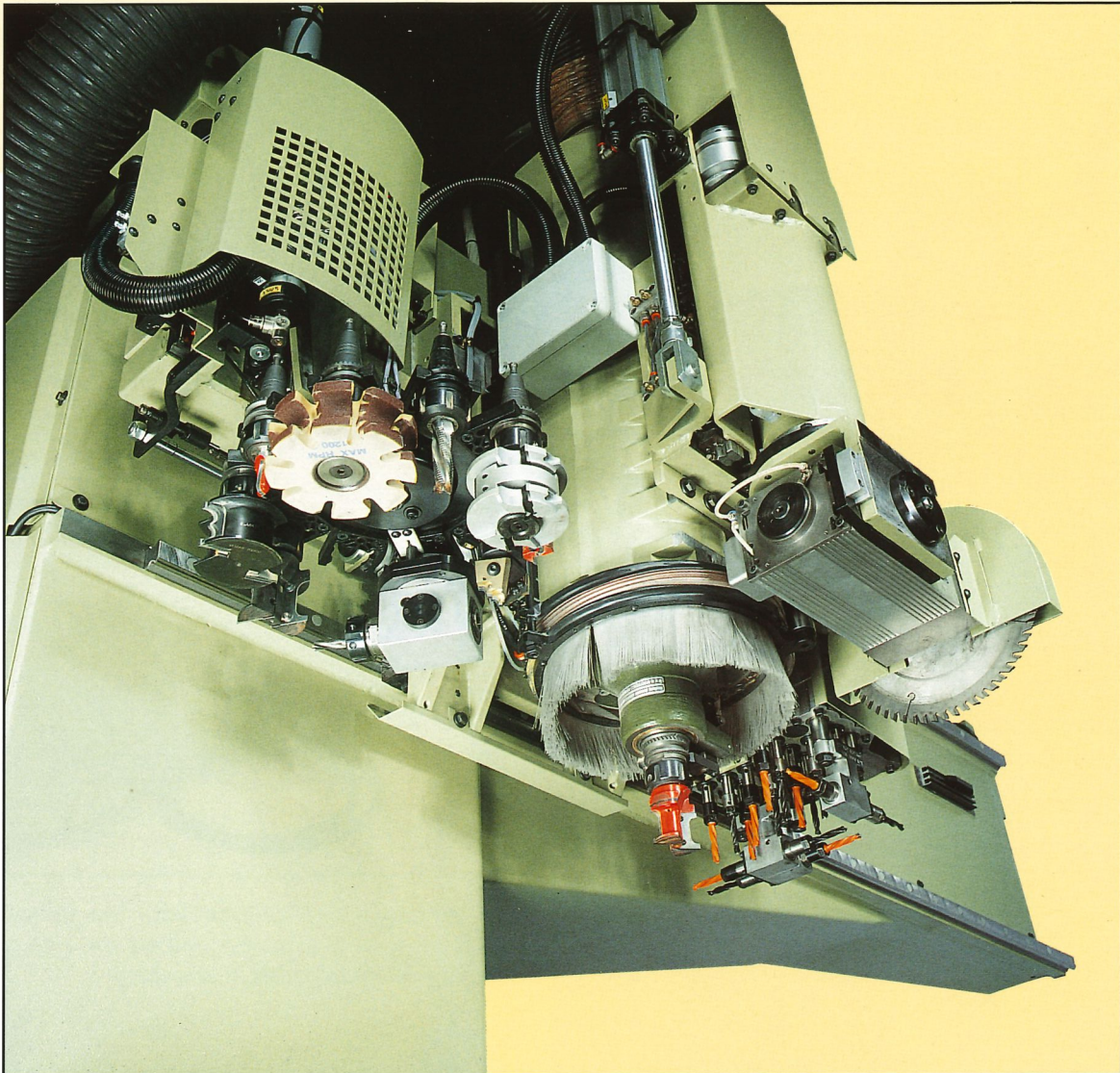

- A **complete** range of functions: horizontal and vertical routing, drilling at various angles, bladesawing are carried out by:
 - High-power vertical spindle with 10-position automatic tool changer.
 - Drilling unit with 10 independent vertical spindles and 6 independent horizontal spindles.
 - Independent powerful unit, horizontally orientable, for routing and sawing operations
- **Powerful** with a 10 or 15 HP electro-spindle.
- **Extremely rigid** structure especially designed to obtain high quality finish and high precision in case of heavy stock removal.
- **Fast** because it changes the router tool during drilling, in masked time.
- **Flexible** because it can use a wide selection of tools: routers, sawblades, sanding pads, angle-drive units, multiple head units all of them fitted in the tool changer.

SCM electro-spindle

A quality choice

The electro-spindle, subject to heavy loading and wear, is one of the most critical components of a machining centre.

This is why SCM has committed substantial resources to the design and development of the entire production cycle for this important unit.

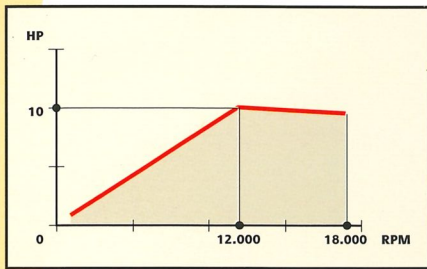

High power

Already available at low rpm due to particularly studied dimension of electrical components and static inverter.

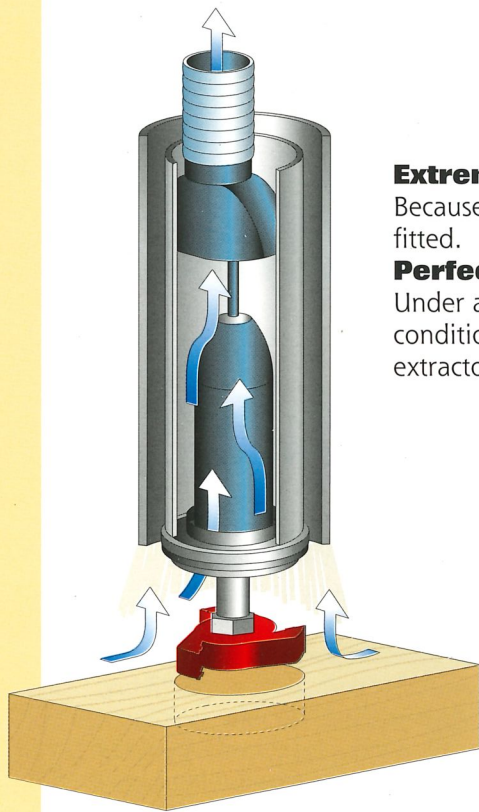

Extremely silent

Because no cooling fans are fitted.

Perfect cooling

Under all operating conditions, using the extractor air flow.

Assembly and test departments

After assembly, all electro-spindles are mounted on test rigs which simulate real working conditions. The rigorous test cycles constantly monitor: temperature, vibration, absorbed current and noise levels.

Test data is transmitted to a computerised system which immediately detects and

indicates any faults; **only the electro-spindles which meet our stringent test specifications are fitted on SCM machines.**

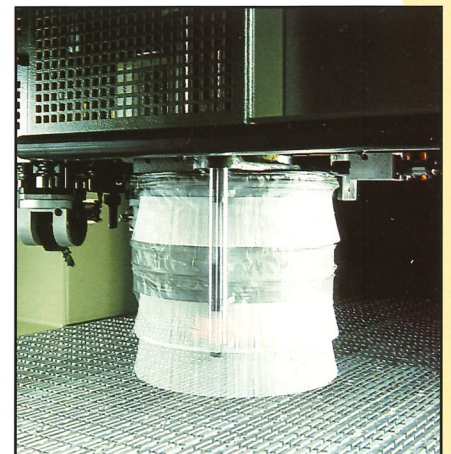

Built-in extractor system

An all-around extractor system collects all dust and shavings from all directions. The height of extractor hood is controlled by CNC to match tool length.



Automatic tool changer

All tools ready for work at any time

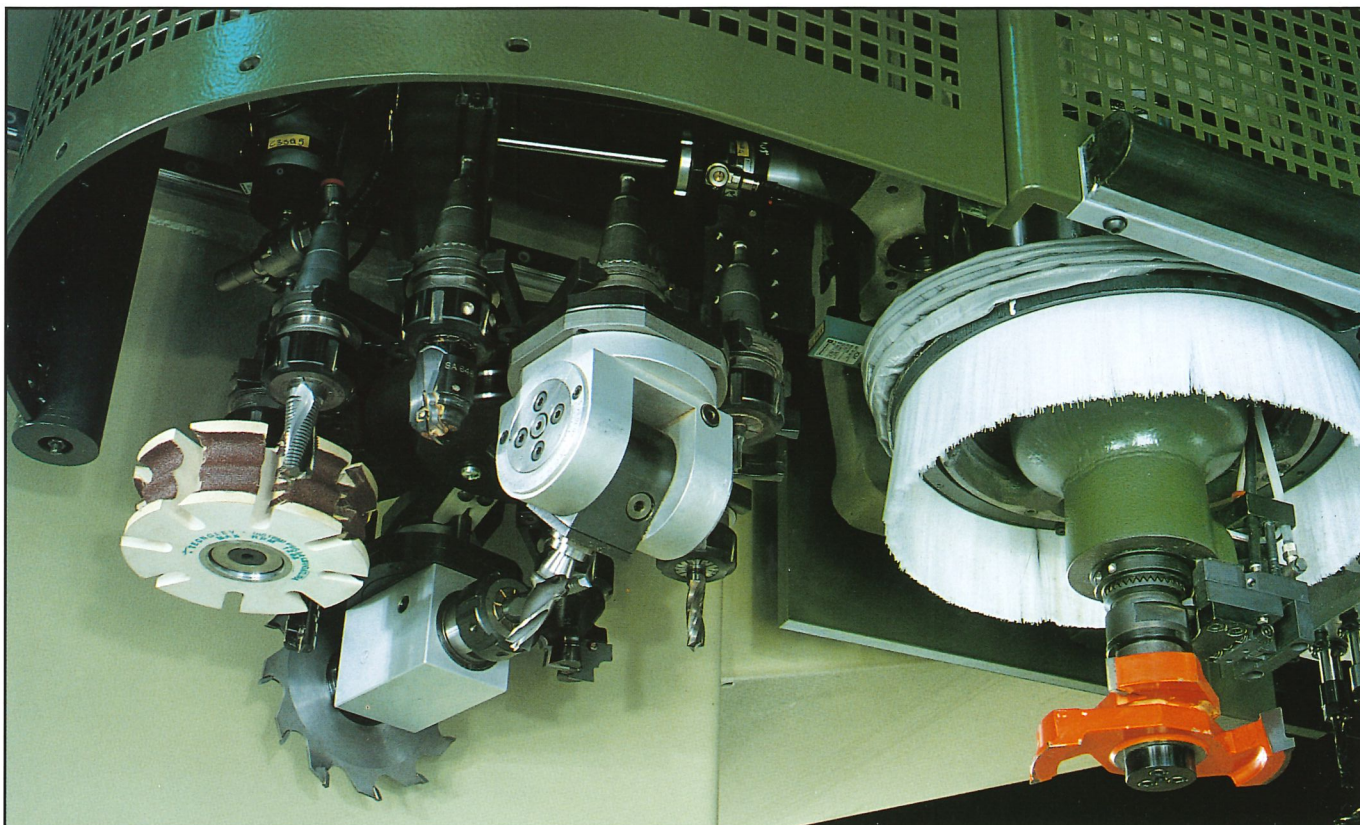

SCM was the first to believe in automatic tool changers on CNC routers. Backed by more than 15 years experience, the SCM tool changer guarantees:

- **reliability**, because more than 2,000 units have been produced and are operating in a wide variety of working conditions.
- **speed**, because there are no down times when changing tools since the tool changer is directly fixed on main electro-spindle.
- **versatility**, because it can carry: routers, sanders, angle-drive units for routing, drilling and sawblades, all at the same time.

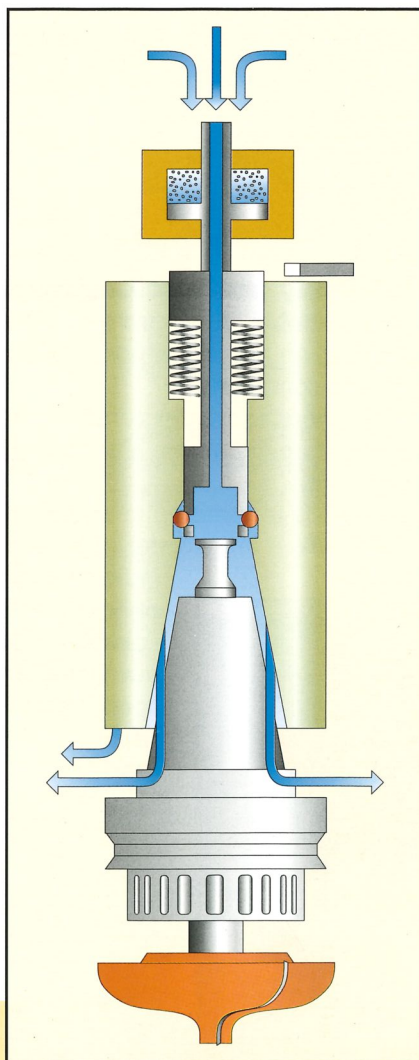

Rapid, safe, automatic tool clamping

An innovative CNC-controlled system which quickly and firmly clamps the tool in the spindle is the key feature of SCM tool changer.

Safety

After the control of each stage of the cycle, CNC gives the final consent signal to the whole processing.

Multiple independent drilling unit Increases machining centre versatility

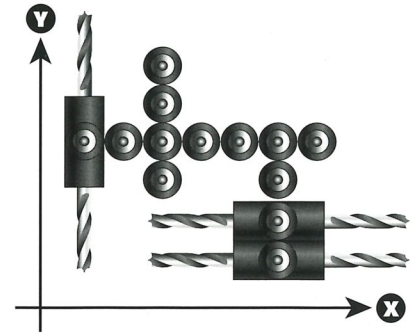
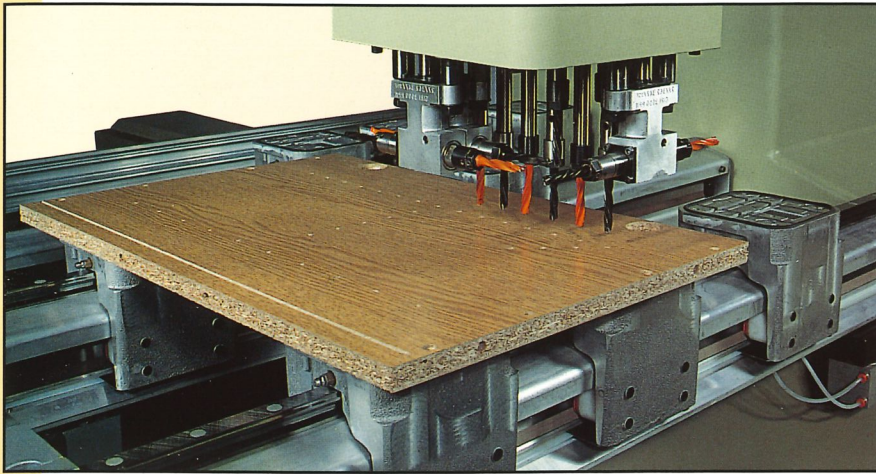

The drilling unit with independent spindles has been developed with a rigid, compact structure and with a CNC controlled vertical travel in order to perform all types of drilling even on solid wood. The unit guarantees maximum drilling speeds even during tool changes and enables a drastic reduction in cycle times.

- The drilling unit consists of :
- 10 independent vertical spindles arranged in a double-T configuration for the rapid completion of hole rows, assembly holes and drillings .
 - 4 independent horizontal drill spindles on the X axis.
 - 2 independent horizontal drill spindles on the Y axis.

“Universal”

Increased power on horizontal machining

Special operating “Universal” unit on horizontal axis with single or double outlet for sawblades or router cutters for:

- Execution of holes and slots for hinges, locks and fitting on doors and windows;
- Moulding with horizontal axis on frames, furniture components, chairs etc..
- Cutting with sawblade on solid wood, chip-board and MDF of components for stairs, chairs, furniture, tops and tables etc.
- Horizontal boring up to 150 mm depth.

Main features

- Collets for tool with shank diameter from 3 to 20 mm
- Equipment to take sawblade with bore of 45 mm (max blade diameter 250 mm)
- Motor power up to 7.5 HP
- Programmable variable speed from 900 to 18,000 rpm

Option of rotary vector axis

- Two-positions 0°-90°, pneumatic
- Two-positions 0°-180° pneumatic
- Programmable angular setting 0-270° from CNC

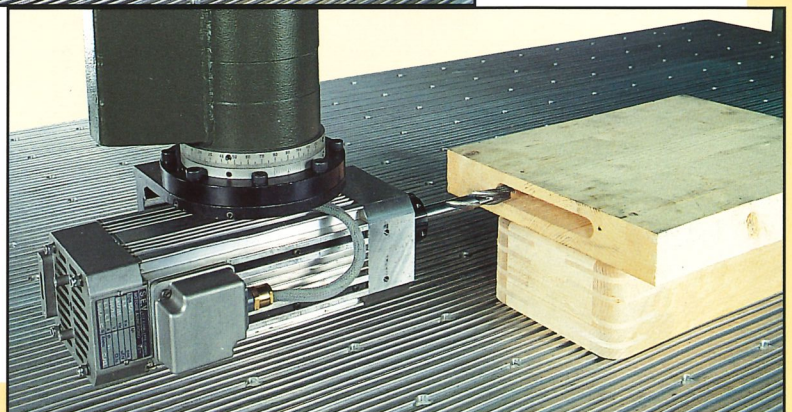
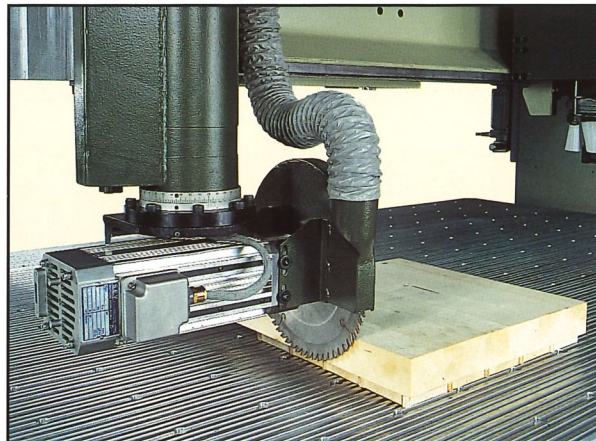

VECTOR

Greater flexibility to angle-drive units

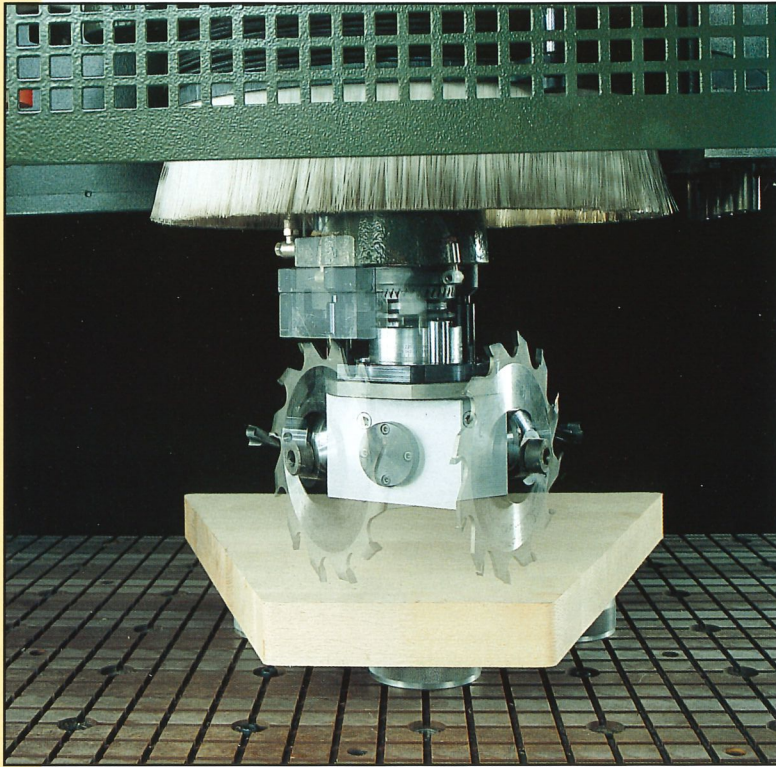

SCM developed the VECTOR unit for all those situations where the angle-drive heads have to operate at different angles (0-360°) on the same component.

VECTOR enables drilling, routing, interpolated routing, horizontal mortising and cutting at any angle on any component without the need for reprocessing.

Its high level of precision combined with the use of the tool changer ensure top quality performance even on complex machining operations.

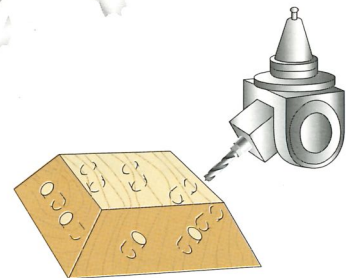
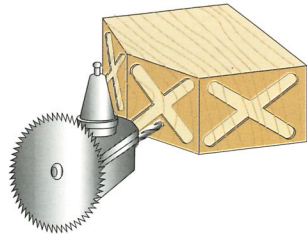
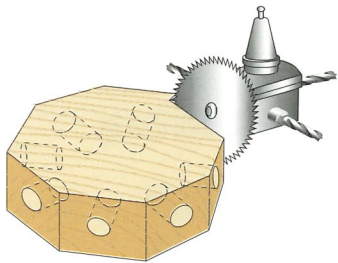
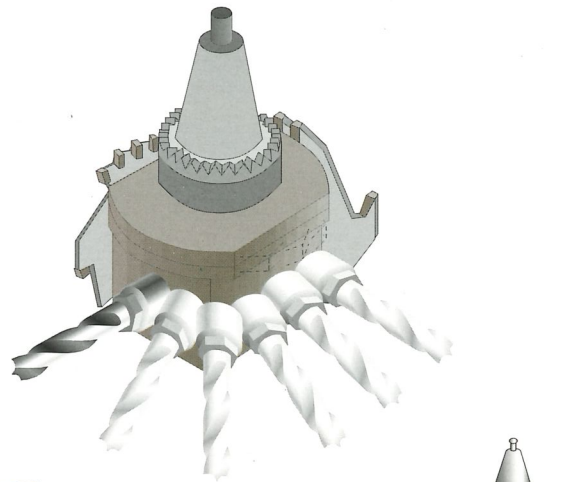

Angle-drive units

RECORD 220 can be supplied with a wide range of angle drive units that can be positioned on the tool changer for horizontal or angled drillings, sawing and routing operations.

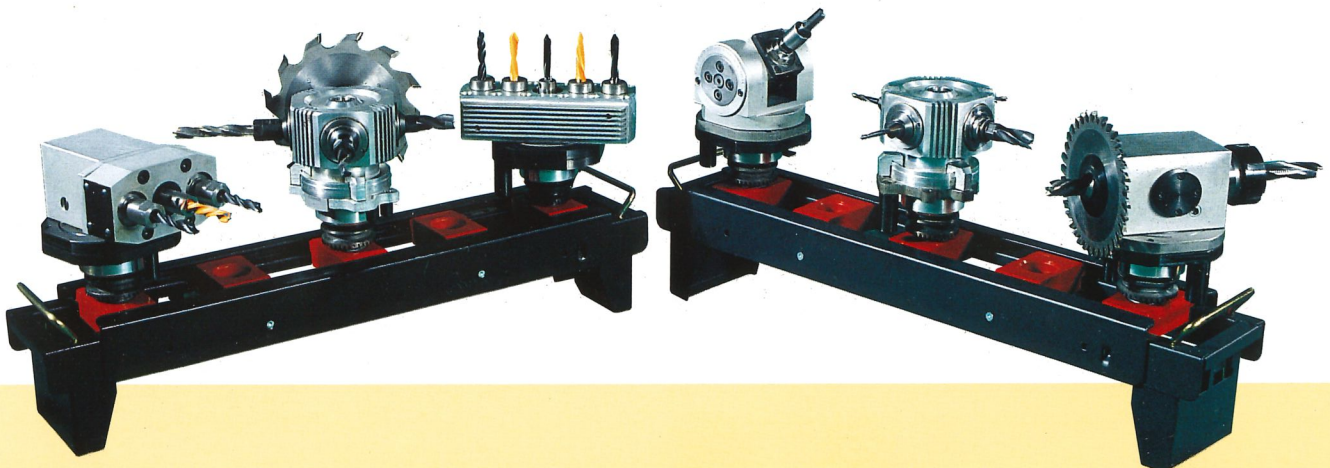

TILTING

The advanced technology for curved components

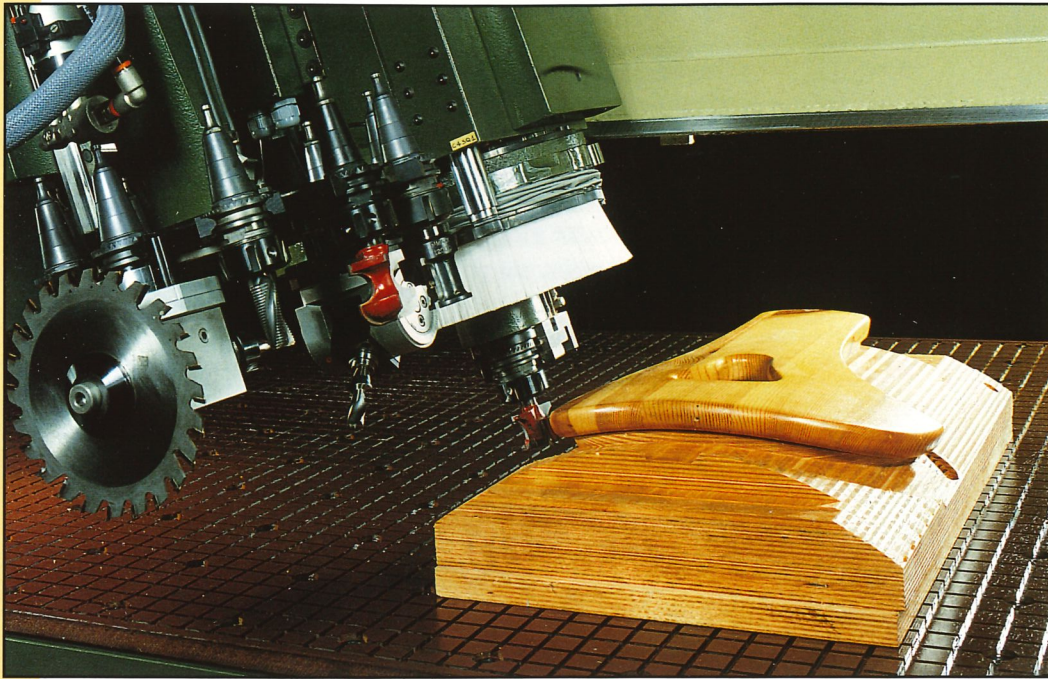

The main limit of normal machining centres lies in the production of curved pieces such as cupboard doors, chair backs or double curve frames where the tool has to tilt according to component profile.

With the SCM TILTING unit (optional), main spindle is CNC tiltable from - to + 45°. Shaping, moulding, slotting, drilling and sanding of any curved component can simply be programmed and executed as for straight work. Dedicated software developed by SCM automatically handles the interpolation of the rotary axis with the other linear axes.

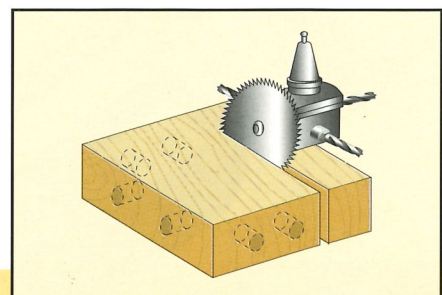
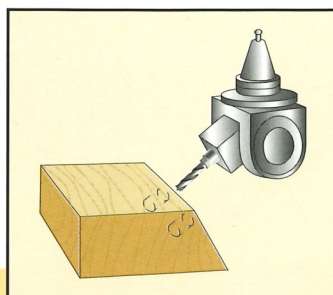
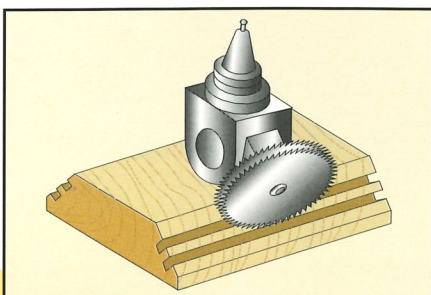
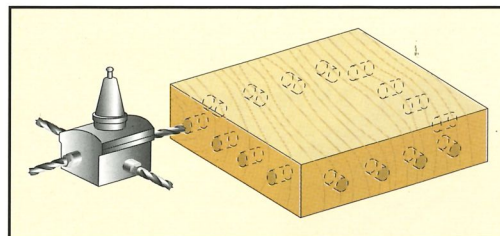
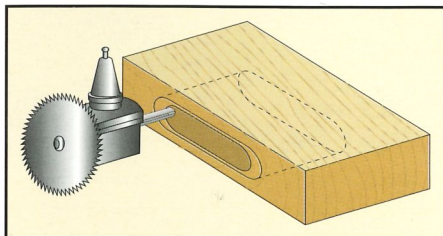
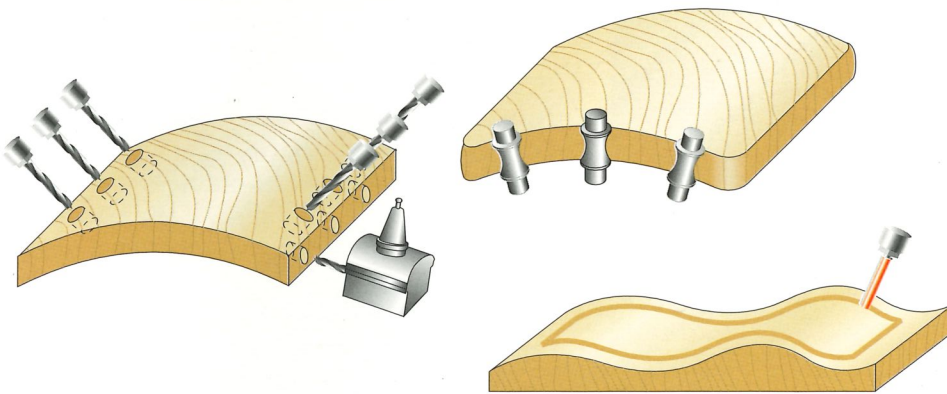

Structural rigidity beyond comparison



The RECORD 220 base has a robust, mono-block construction, strongly ribbed to withstand the high loading which occurs during machining and accelerations. This solid construction gives the RECORD 220 superior finishing performance even under the most severe operating conditions.

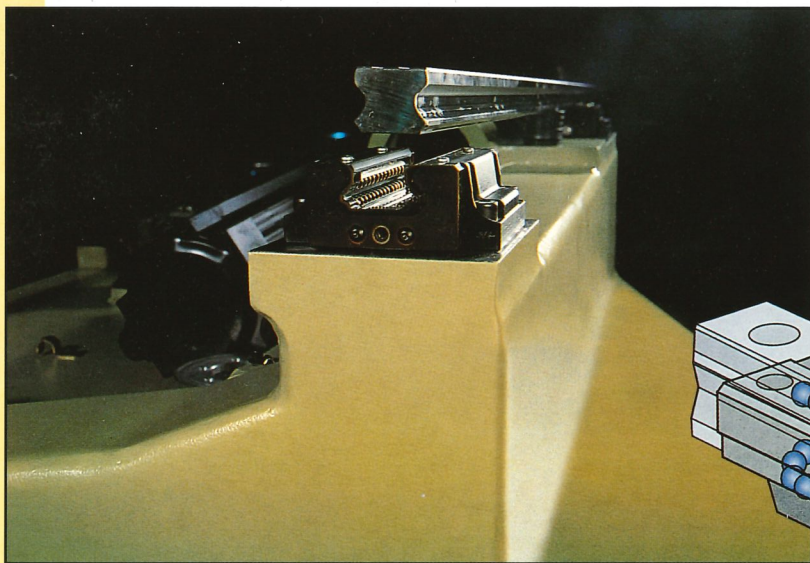

Prism guides

Prism guides with sliders running on pre-loaded recirculating ball screws to ensure the maximum rigidity and smooth operation required for a high quality finish in all operating conditions.

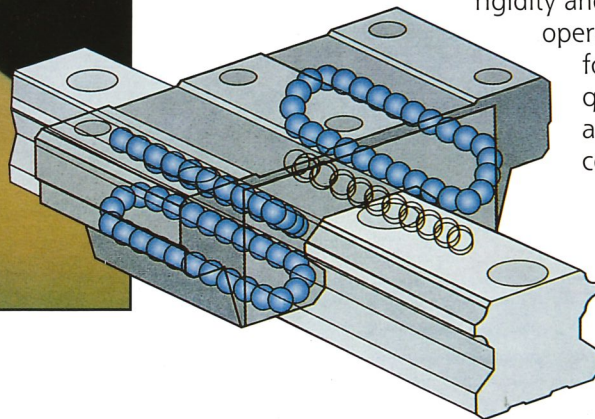

Fixed lead screws

Fixed lead screws, locked at both ends, with rotary lead nuts coupled to the motor by a direct drive, ensure vibration-free movements and maximum precision even during path changes and high accelerations.



Computer Numerical Control unit

Easy and quick to program

The RECORD 220 numerical control is a next generation CNC unit with fast microprocessors for rapid calculation and top interpolation capability. Easy to use, the CNC makes the operator-machine dialogue simple and immediate.



The main CNC features are:

- 32-bit microprocessor for maximum processing speed and fast program running times.
- Multi-tasking : to program the machine while it is working.
- 10.5" colour LCD with high graphic resolution.
- PC-type alphanumeric keyboard.
- Graphic display of programmed part geometry with dynamic tool path display; the current tool is displayed from component top or side surface.
- Programming with sub-programs called up from any main program.
- Parametric programming with mathematical calculations (139 variables available).
- Serial transmission links for program loading and unloading.
- Floppy disk drive, on request, supplied with **PC card Windows compatible**.
- Automatic tool magazine management.
- Automatic tool length and diameter correction.
- Programmable machining speeds to enable slowing for finishing tasks.
- Programs can be run directly from an external PC.
- Automatic tool path acceleration control for an optimum finish.
- Zoom function to display parts in details.
- Override function for the separate adjustment of axis and spindle speeds.
- Editing mode for correcting work programs.
- MDI (semi-automatic) mode for rapidly programming test cycles without storing them.
- Integrated PLC for the rapid, safe handling of machine cycles.

ASTROCAD

Automatic programming system

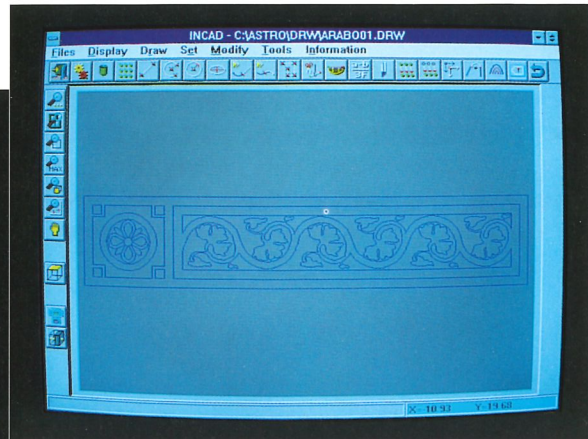
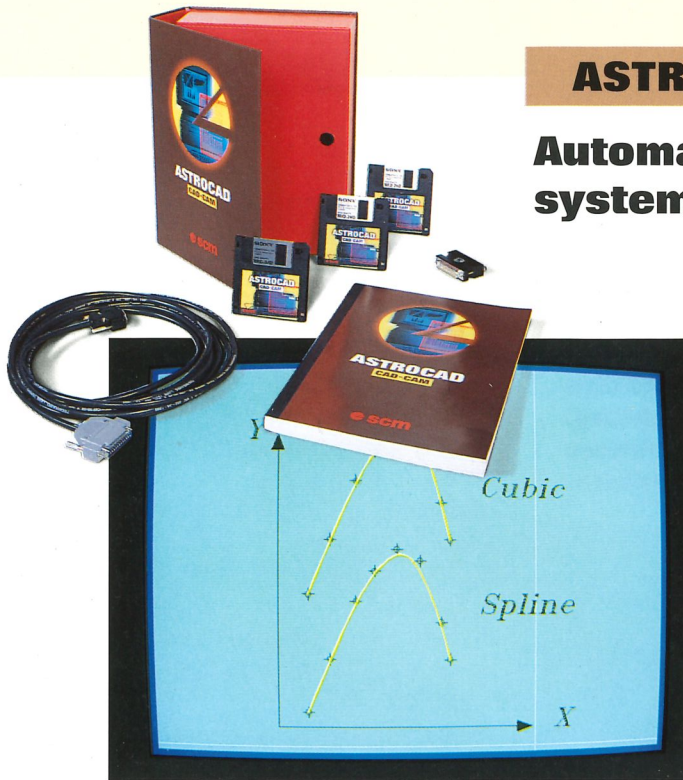

A powerful, innovative CAD-CAM program with drawing, calculating, self-teach and programming functions.

With **ASTROCAD** high performance functions, the machine reaches its full potential. Use **ASTROCAD**:

- to assign machining task to each part of the component while drawing its geometry.
- to generate the CNC program while you are drawing the workpiece.
- to rapidly complete parametric drawings and their respective CNC programs.
- to automatically execute pockets, recesses, cycles and pre-configured sub-programs.
- to make changes to component drawings and automatically up-date the CNC program with any modifications.
- to simulate tool paths and work cycles and to test a program before it is executed.
- to calculate machining times.

- to calculate the cost of machined components.
- to load part geometry in the self-teach mode using masters or scale drawings made with graphics tablets and digitizers.

ASTROCAD can be used with AUTOCAD® or any ".DXF" format CAD to provide total integration between your design and manufacturing departments.

ASTROCAD is part of the machine.

Once the drawing stage has been completed, the program is generated immediately without the need for further information because AstroCAD "knows" the codes of the machine, having already stored the machine configuration to memory.

ASTROCAD is easy to use. All functions are menu-guided with windows and icons. All you need is a Personal Computer loaded with "Windows" programm, now widely available. (The PC is not supplied by SCM).

ROUTOLINK

Simple, guided machine-operator dialogue

ROUTOLINK is the SCM-designed user interface incorporated in the CNC unit to ensure easy machine operation and programming without the need to know complicated codes.

Windows and icons displayed on the monitor guide the operator logically through the steps needed to select and activate machine functions.

ROUTOLINK has an integrated CAD for drawing simple component geometries, the program then automatically generates the corresponding part program in real time.

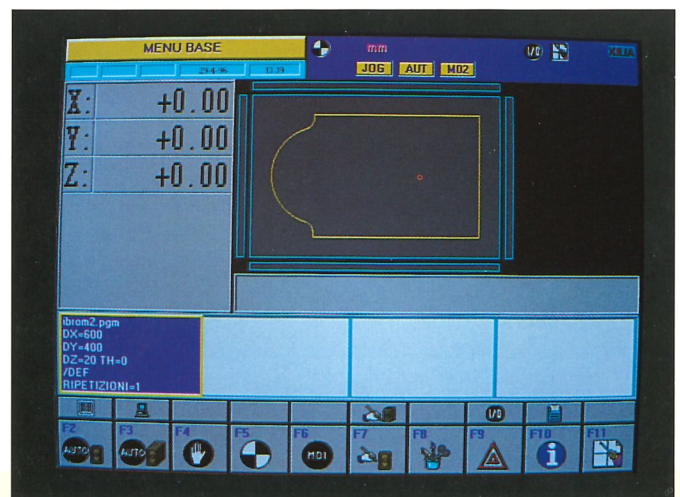

Horizontal working area

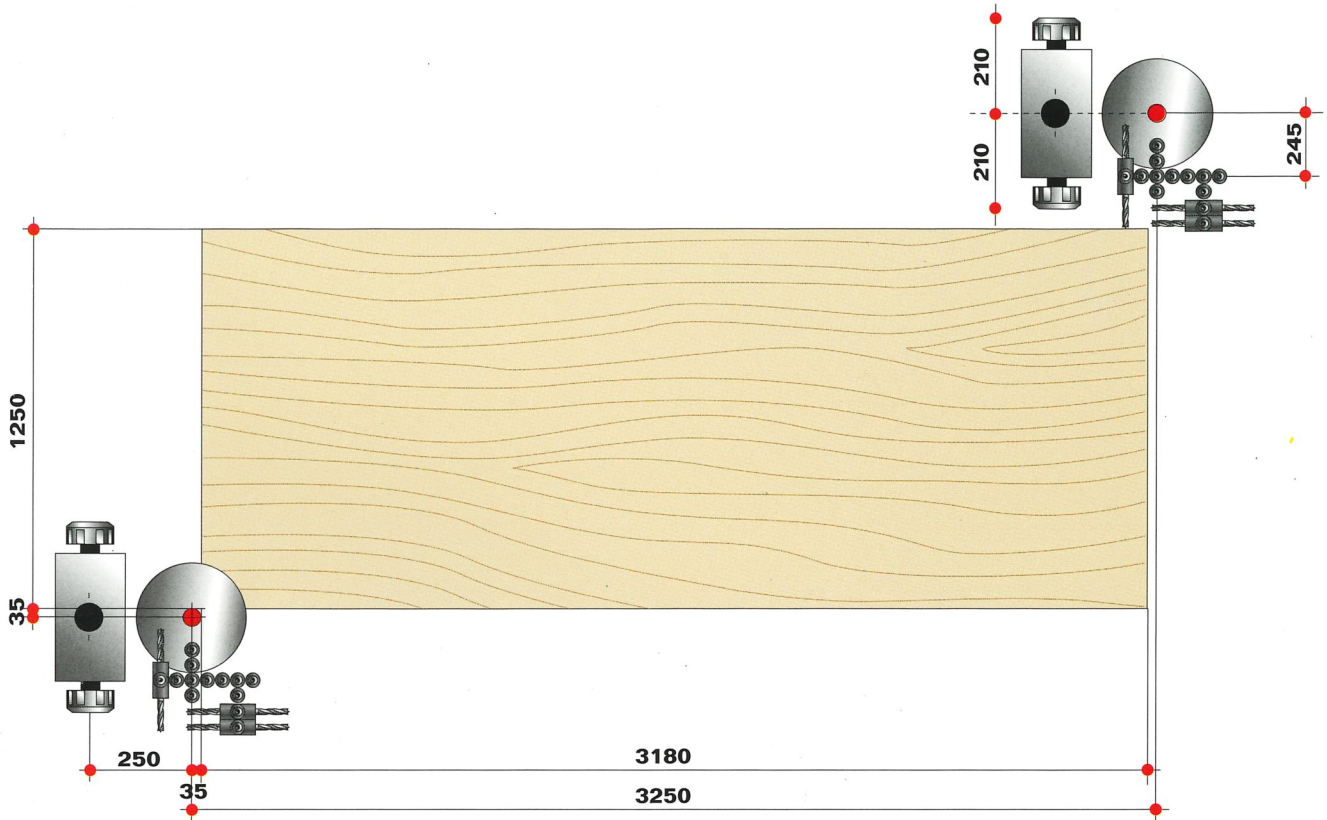

Vertical machining strokes of operating units

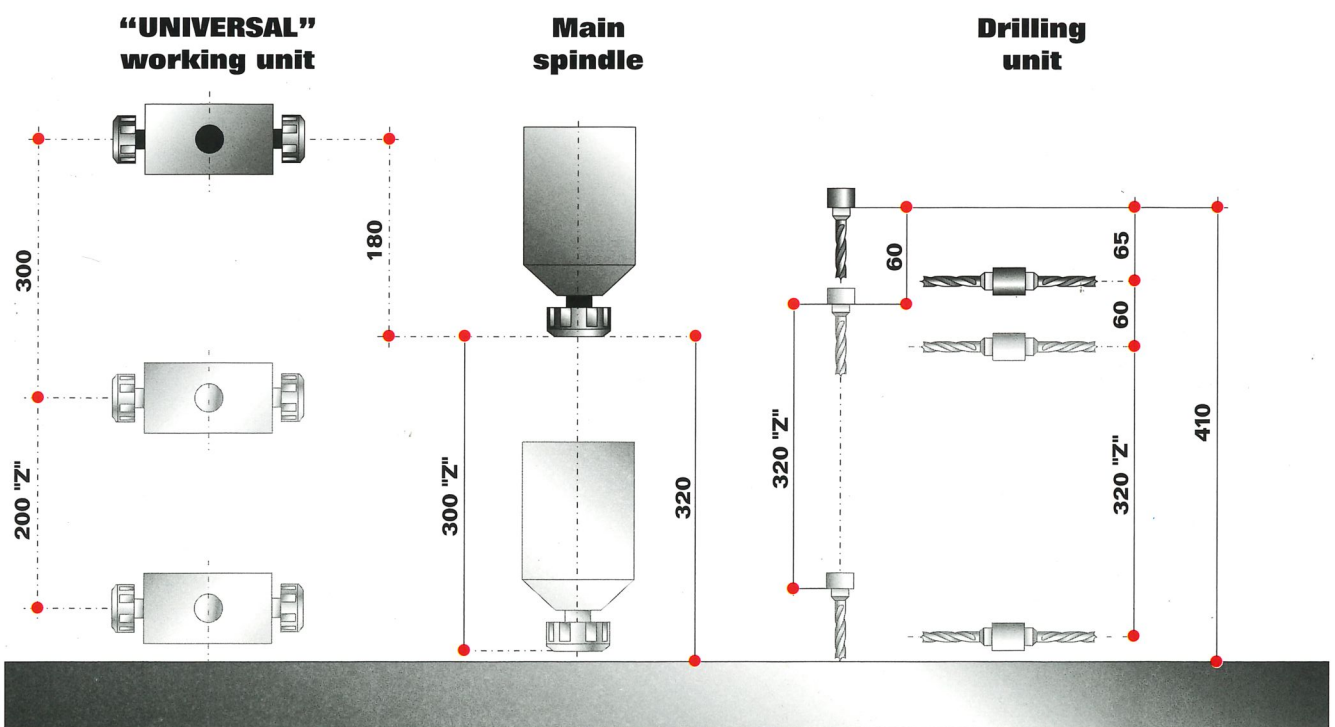

Overall dimensions

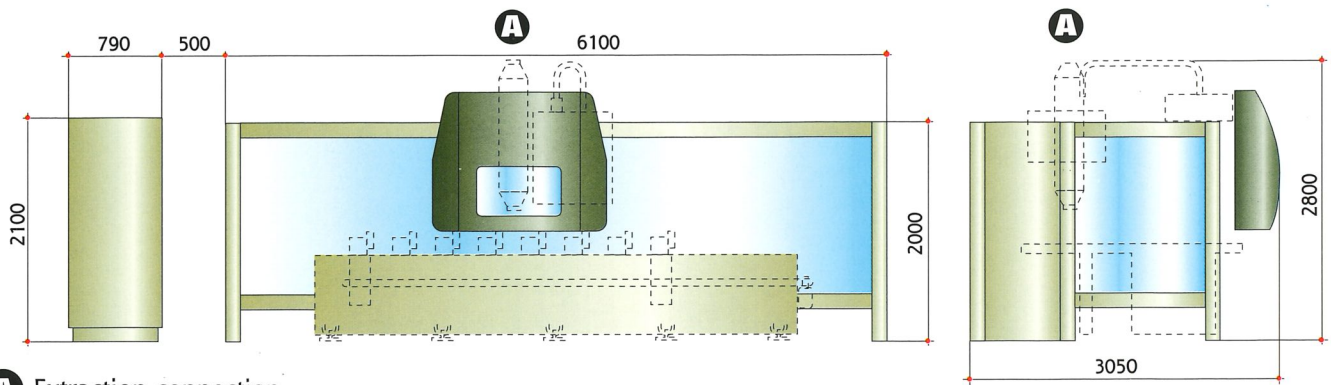

A Extraction connection

Technical data

Working area covered by main router unit	3,180x1,250 mm
Working area covered by all units	2,860x1,160 mm
Maximum height between table and spindle	320 mm
X-Y axis stroke	3,250x1,300 mm
X-Y axis acceleration	2 m/sec ²
X-Y axis rapid travel speed	45m/min

Router unit

- Electro-spindle ISO-30	
- Speed	900 ÷ 18,000 rpm
- Power	10 HP at 12,000 rpm
- Z axis travel	300 mm
- Rapid travel speed	45m/min

Drilling unit

- 10 independent vertical spindles	
- 6 independent horizontal spindles	
- Speed	3,000 rpm
- Motor power	3.5 HP
- Pneumatic on-off vertical travel, each spindle	60 mm
- Z axis stroke	320 mm

Horizontal axis unit

- Speed	up to 18,000 rpm
- Motor power	up to 7.5 HP
- Pneumatic on-off vertical travel of complete unit	300 mm
- Extraction central duct diameter	Ø 150 mm
- Extraction air flow rate	30 mt/sec
- Extraction air consumption	2,000 m ³ /hr
- Compressed air pressure	7 bar
- Compressed air consumption	50 NI/min
- Power supply	380/50 V/Hz, three-phase
- Installed power	22 KW
- Weight	7,500 kg

In this catalogue machines are shown with optionals. The firm reserves the right to modify technical specifications without prior notice, provided that such modifications do not affect EC certification safety in EC configurations.



Safety, what you should expect

Where required, the machine is supplied with the following parts complying with the CE safety regulations

- Safety and warning messages and labels on the machine
- Instruction and maintenance manual
- Electrical emergency devices

- Electrical components and visual warning devices
- Guards for moving parts
- Component ejection guard
- Interlocks and safety devices to prevent accidental or unauthorised access to hazardous areas.

NOISE LEVELS		
RECORD 220	No load without extractor	Machining
Average noise level on measurement surface dB (A)	67,7	81,8
Average noise level emitted dBW (A) [mW (A)]	86,7 [0,5]	100,8 [12,0]
Average noise level at operator position dB (A) [dBmax]	67,7	84,4 [91,0]





SCM has been an active force in the woodworking machinery sector for more than 40 years and represents the nucleus of SCM Group which now has a total of 2300 employees, 27 associate companies, 16 factories and an export which accounts for 70% of its production.

customers because full use is made of a system of remote computerised diagnostics and of a network of peripheral spare parts warehouses. SCM's customers can moreover rely upon the Customer Satisfaction Service recently installed as a reference point covering all their requirements.

All this makes SCM one of the world's top producers of woodworking equipment.

SCM produces the widest range of tooling machines for secondary wood machining, from classical machines to CNC work centres, to high production automated systems for the machining of solid wood.

All SCM machines are designed with the aid of CAD (computer aided design) systems and manufactured using the most modern machining and control technology. Specialized technicians all over the world are able to supply the most comprehensive technical assistance and services for SCM

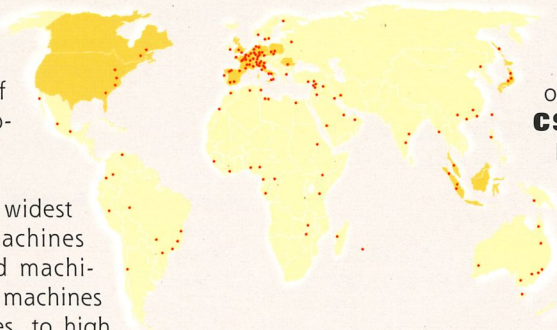

SCM can also utilize the internal structures of SCM Group such as **CSR - Study and Research Consortium** and CSR Training Centre. CSR - Study and Research Consortium uses advanced experimental and an acoustic instrumentation laboratory fitted with a semi-anechoic room.

This ensures that all machines satisfy the strictest international standards in terms of safety, ergonomics and environmental hygiene. **CSR - Training Centre**, a highly regarded training school prepares qualified operators for woodworking machinery from all over the world.

This ensures that all machines satisfy the strictest international standards in terms of safety, ergonomics and environmental hygiene. **CSR - Training Centre**, a highly regarded training school prepares qualified operators for woodworking machinery from all over the world.

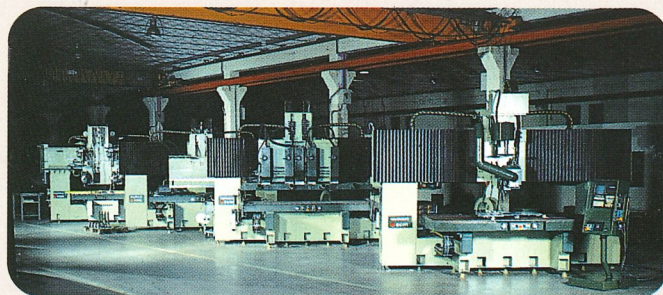

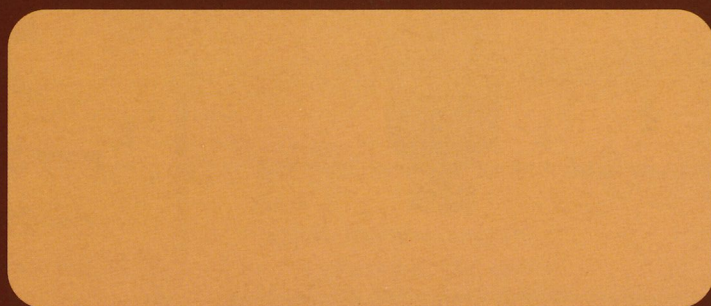

SCM spa
Via Emilia, 71
47037 Rimini - Italia
Tel. 0541/700111
Fax 0541/700181