

STEFANI

Italiano - English - Español

Bordatrici monolaterali elettroniche
NC single-sided edgebanders
Chapeadoras monolaterales
electrónicas

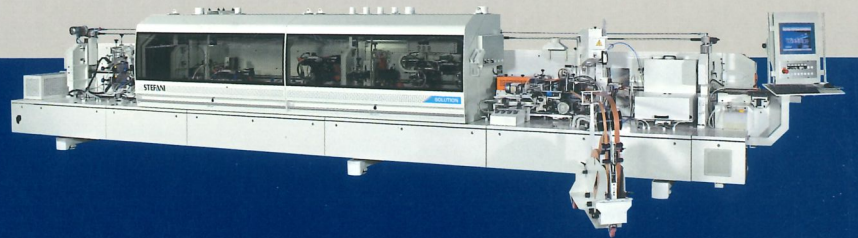

Solution

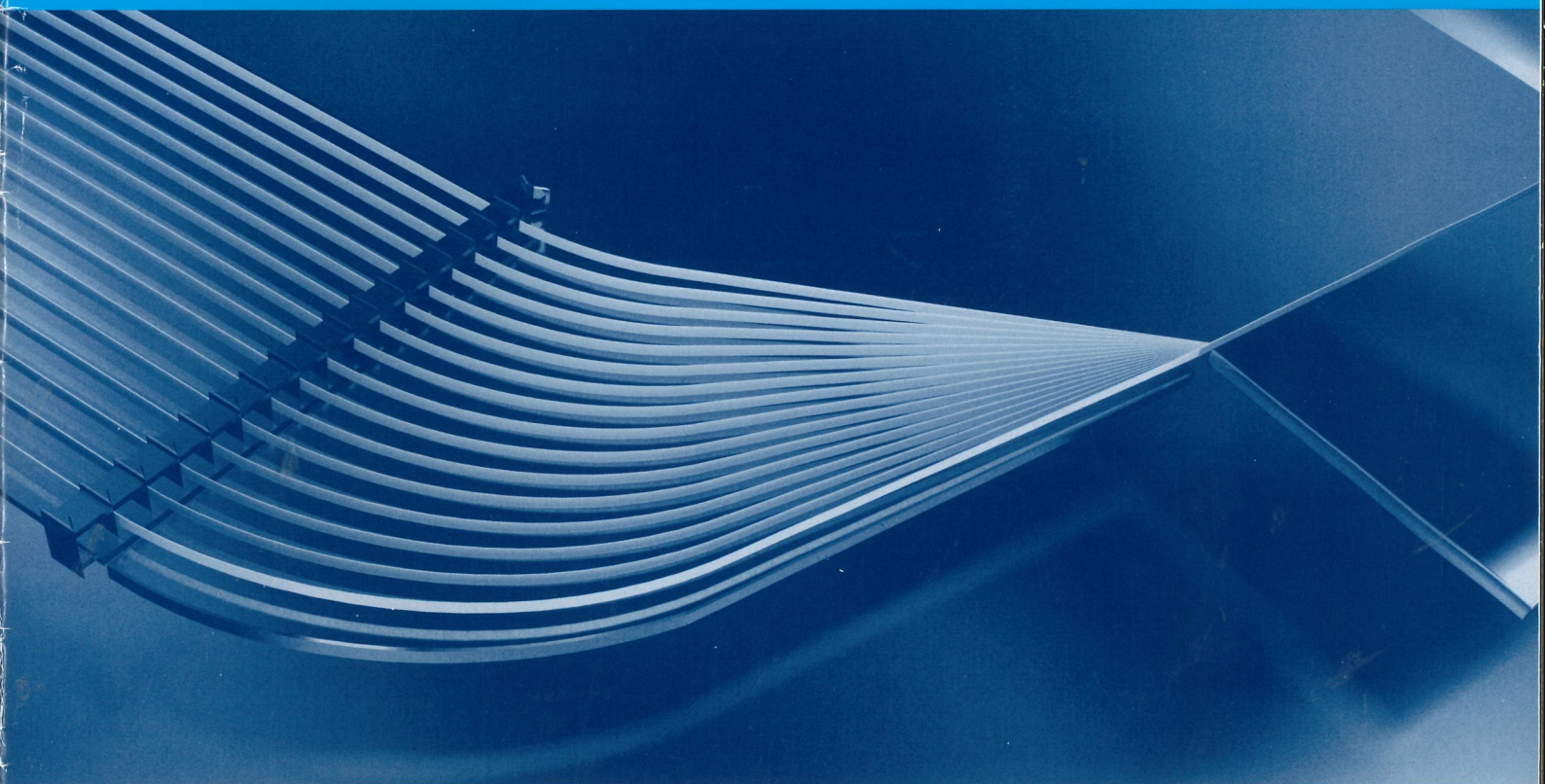

STEFANI

Elevata tecnologia di bordatura
Top level edgebanding technology
Elevada tecnología de chapeado

Solution soddisfa ogni esigenza di bordatura garantendo la massima precisione di lavorazione e l'affidabilità nel tempo. Solution è la sintesi della più elevata tecnologia di bordatura e può essere allestita per l'applicazione di bordi sottili, ABS e massello, per l'applicazione di bordi in alluminio o per lavorazioni soffforming.

Solution meets every edgebanding requirements and guarantees the highest working precision and its reliability in the future. Solution represents the highest edgebanding technology and can be equipped for thin, ABS and solid wood edges processing, for aluminium edges processing or soffforming processing.

Solution satisfice cada exigencia de chapeado garantizando la máxima precisión de trabajo y fiabilidad en el tiempo. Solution lleva la más elevada tecnología de chapeado y puede ser equipada para la aplicación de cantos delgados, ABS y madera maciza, para la aplicación de cantos de aluminio o para trabajos soffforming.

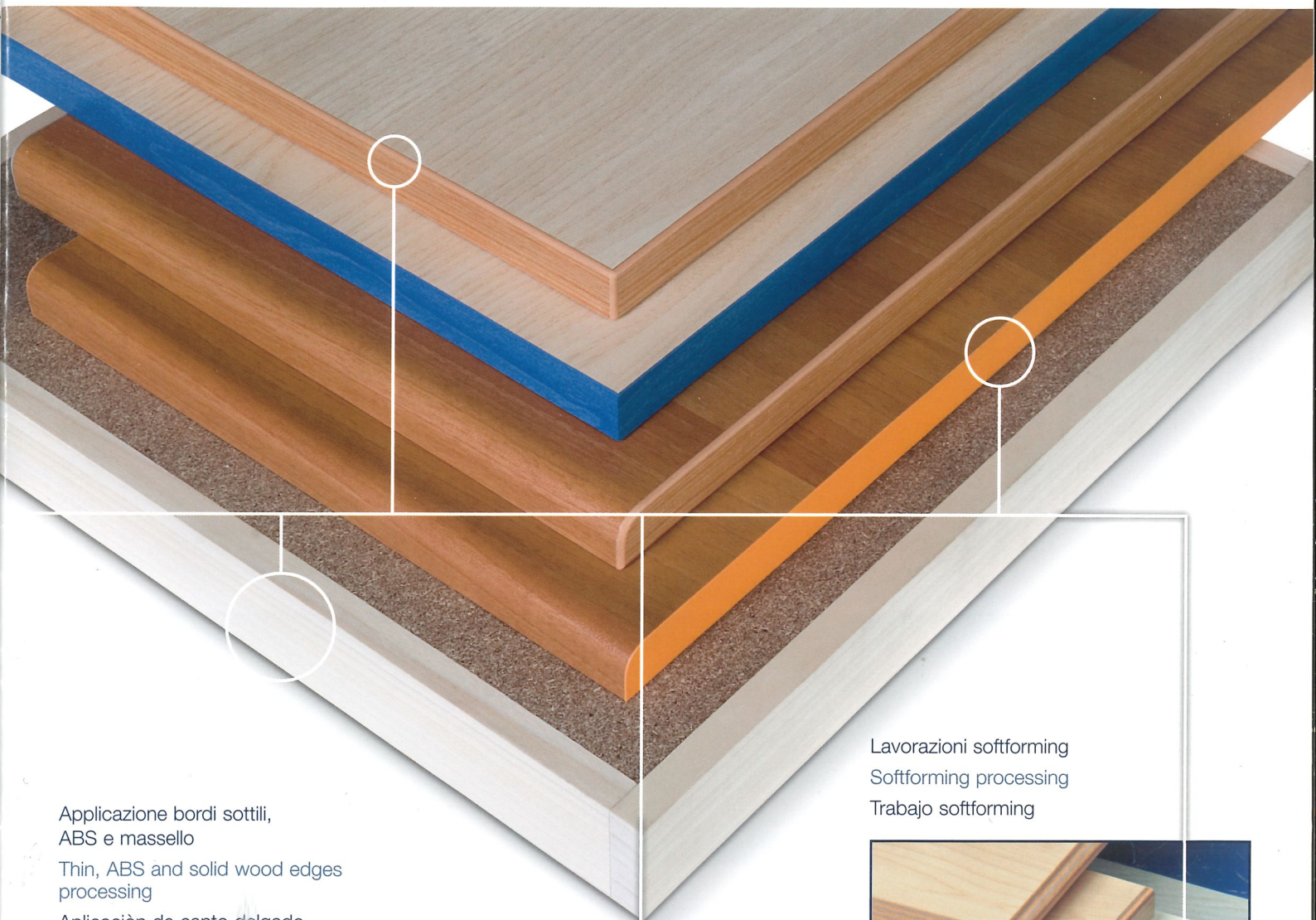

Applicazione bordi sottili,
ABS e massello
Thin, ABS and solid wood edges
processing
Aplicación de canto delgado,
ABS y macizo

Lavorazioni soffforming
Soffforming processing
Trabajo soffforming

Applicazione bordi in alluminio
Aluminium edges processing
Aplicación de canto de aluminio

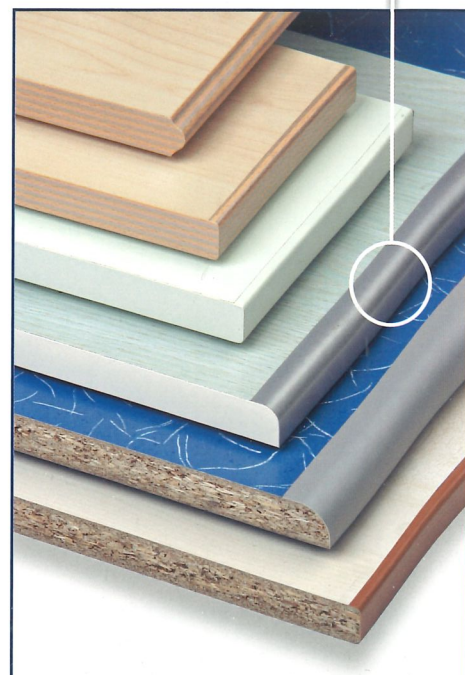
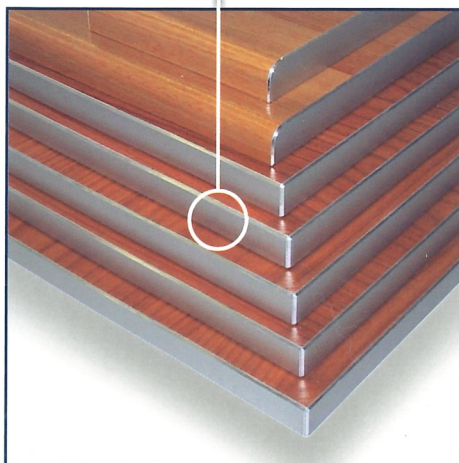

Solution

Bordatrice monolaterale elettronica
NC single-sided edgebander
Chapeadora electrónica monolateral

Sopratavole con possibilità di spostamenti
su guide lineari a ricircolo di sfere
Movable sub-bases on prismatic guides
Sobremesas con posicionamento sobre
guías lineares con recirculo de bolas



Struttura in acciaio solida e resistente
Steel solid and duty beam
Estructura de acero sólida y resistente

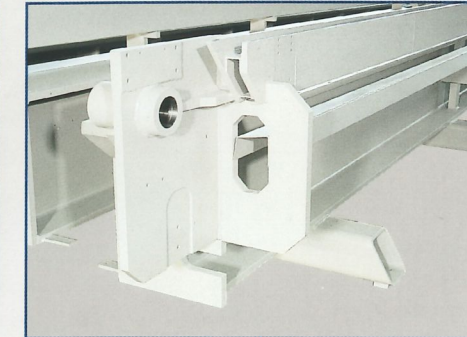

Pressore superiore in acciaio a cinghia
larga o a ruotini
Steel top pressure beam with large belt
or idle wheels
Prensor superior de acero con correa
ancha o con rodillos

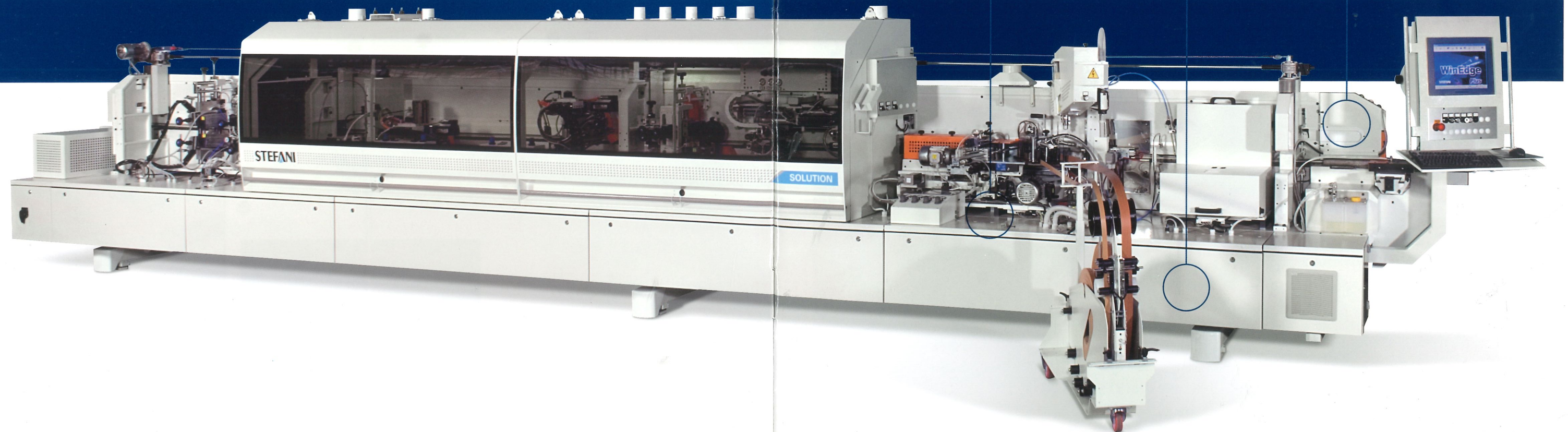
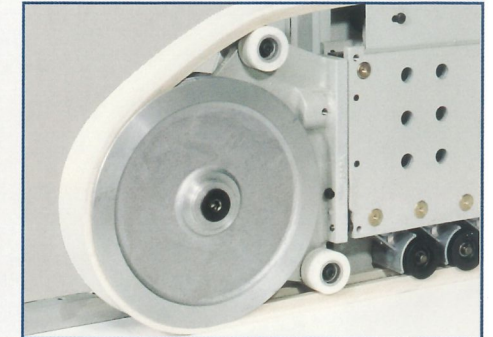

Preparazione del pannello

Panel preparation

Preparación del panel

Guida in entrata ad asse
controllato (opzionale)

NC controlled infeed
guide (optional)

Guía en entrada con eje
controlado (opcional)

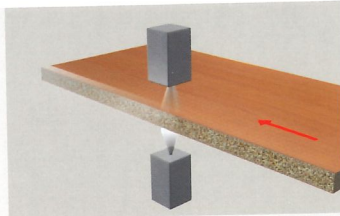
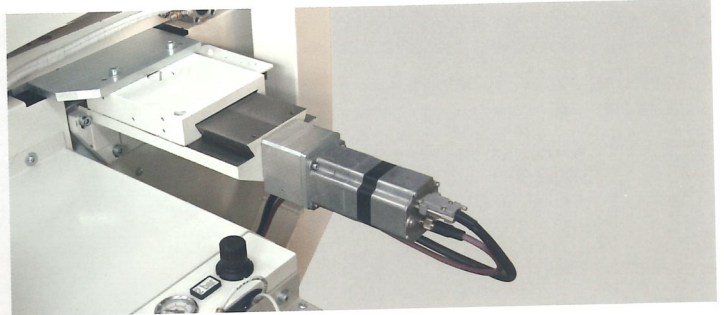

Gruppo antiadesivizzante

Anti-adhesive unit

Grupo antiadhesivo



Il sistema di aspirazione
ottimizzato ED-SYSTEM
migliora la qualità
e il rendimento dell'aspirazione
utilizzando utensili e cappe
di aspirazione specificatamente
studiati per questo scopo.

The optimized ED-SYSTEM
improves the chip suction's
quality and performance
by means of tools and suction
hoods precisely designed
for this purpose.

El sistema de aspiración
optimizado ED-SYSTEM mejora
la calidad y el rendimiento
de l'aspiración utilizando
herramientas y campanas
de aspiración Estudiados
specificamente para este
objeto.

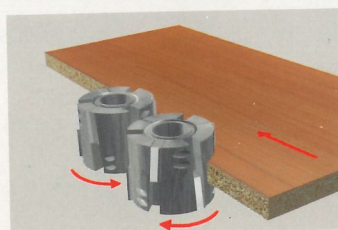
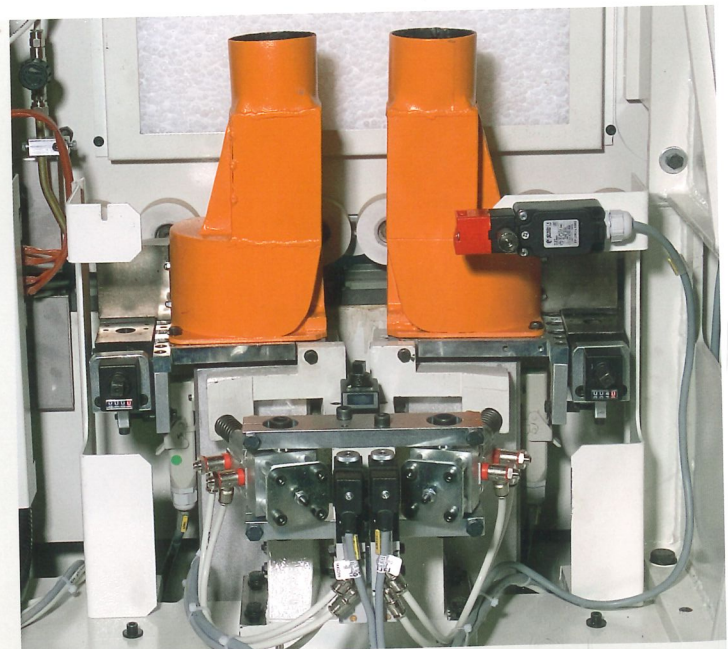

Gruppo rettificatore

Pre-milling unit

Grupo rectificador

Incollaggio del bordo

Gluing application

Encolaje del canto

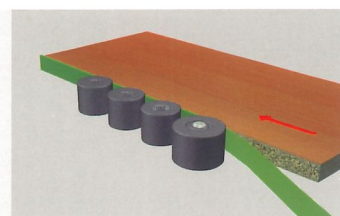
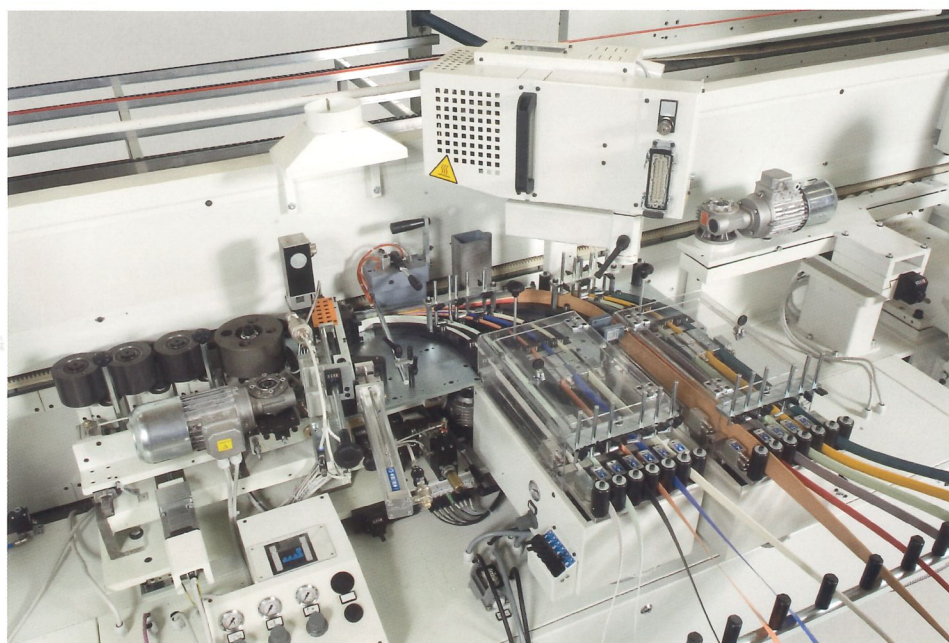

Gruppo incollaggio
Gluing unit
Grupo encolador

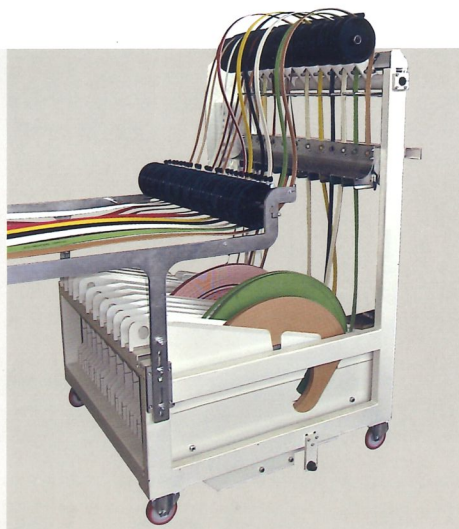
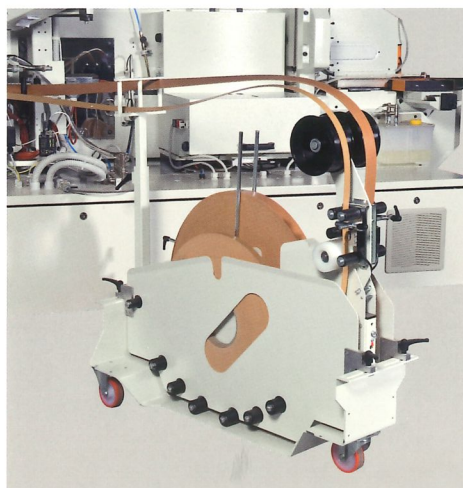

Portarotoli da 2 a 12 rotoli
2 to 12 coils holders
Llevarollos desde 2 hasta 12 rollos

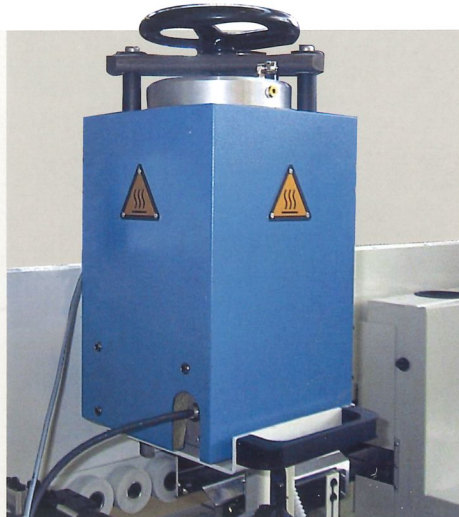

Kit applicazione colla poliuretànica (PUR)
PUR glue process device
Kit aplicaciòn cola poliuretànica (PUR)

Gruppi di finitura

Finishing units

Grupos de acabado

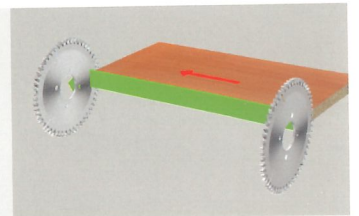
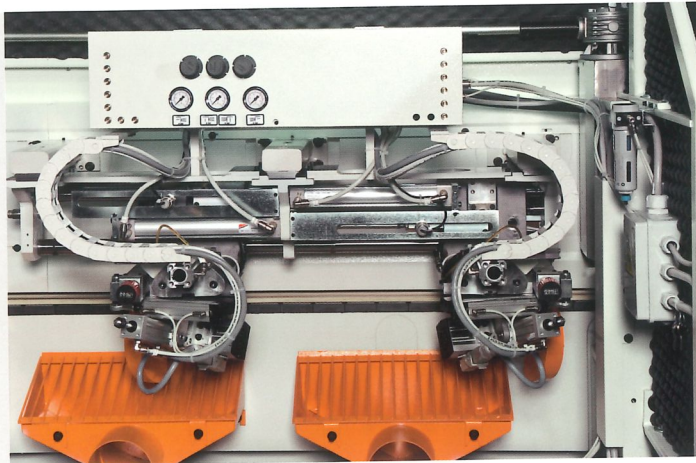
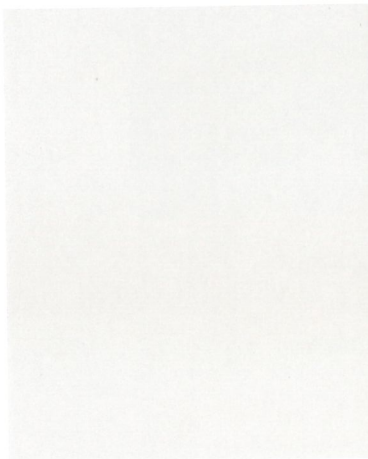

Gruppo intestatore
End-trimming unit
Grupo retesteador

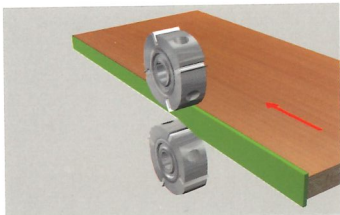

Gruppo rifilatore
Trimming unit
Grupo refilador

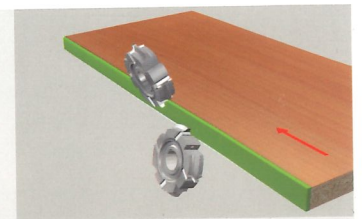
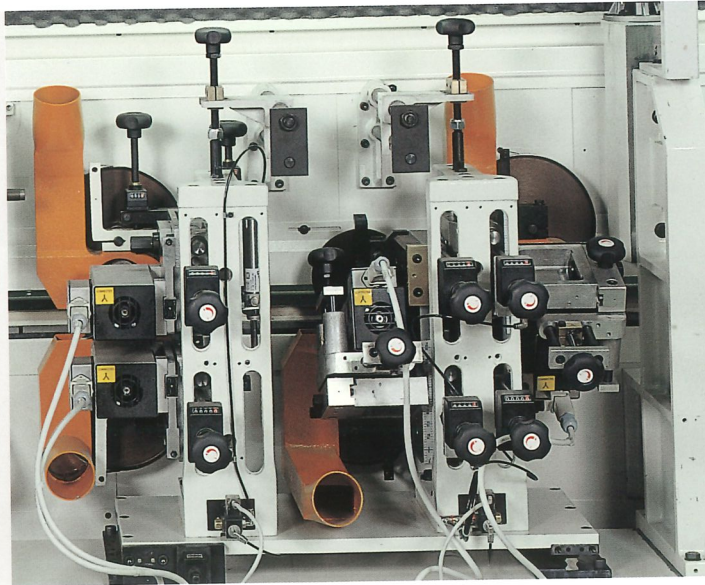

Gruppo spigolatore
Fine trimming unit
Grupo biselador

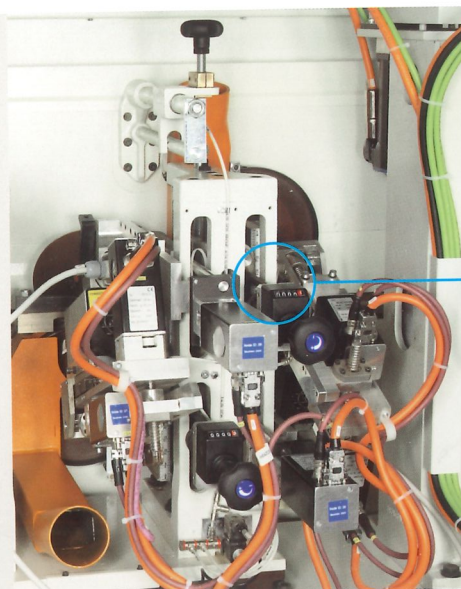
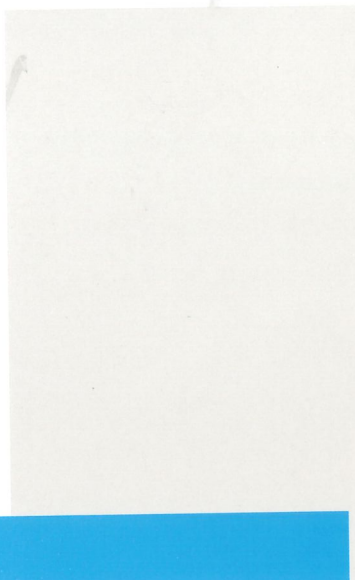

Gruppo spigolatore multifunzione
Multifunctional fine trimming unit
Grupo biselador multifunción

Solution

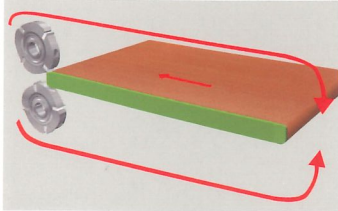

Gruppo arrotondatore-
spigolatore elettronico
con cambio utensili
automatico

NC controlled corner rounding
trimming unit with automatic
tool change over

Grupo redondeador-biselador
electrónico con cambio
herramientas automático

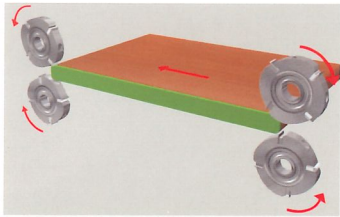
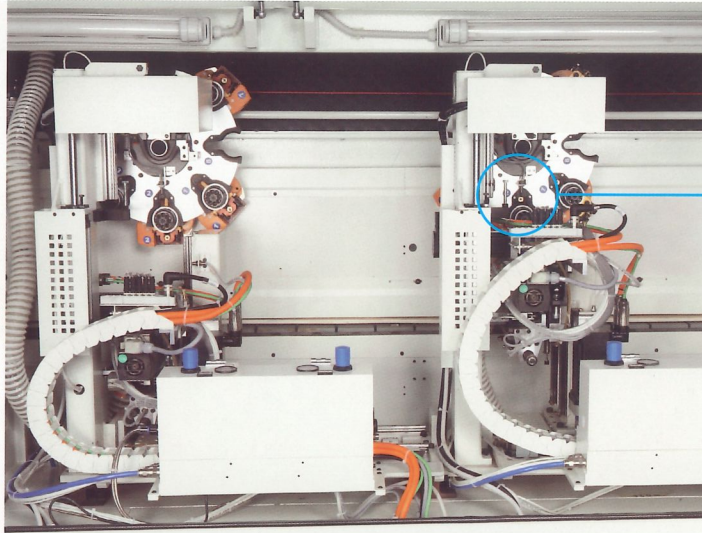

Gruppo arrotondatore
4 motori

4 motors corner
rounding unit

Grupo redondeador
4 motores

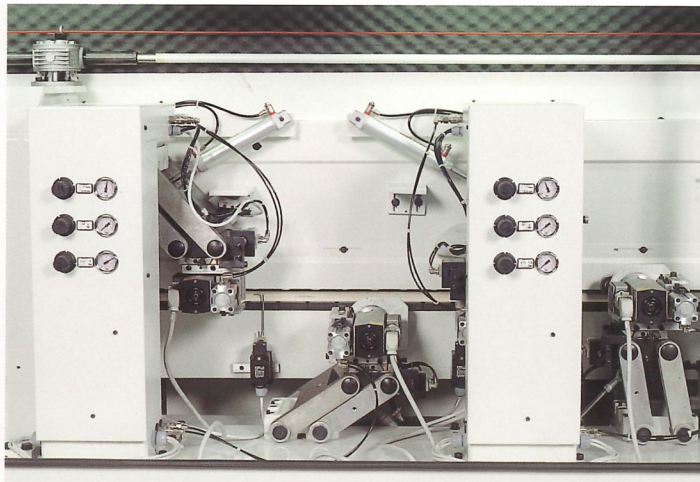

Gruppo arrotondatore
4 motori multifunzione

Multifunctional
4 motors corner rounding unit

Grupo redondeador
4 motores multifunción

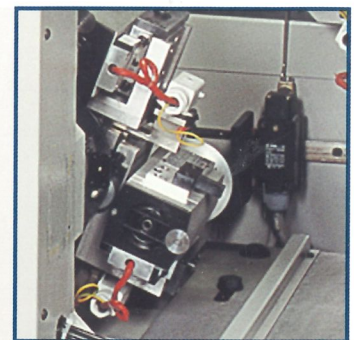
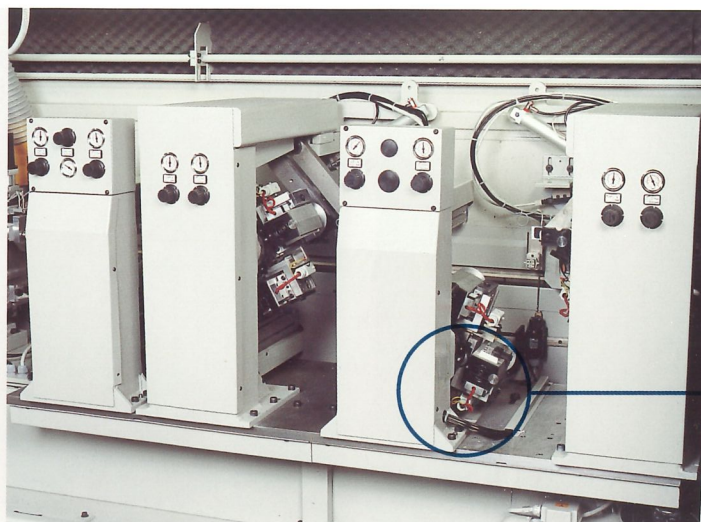

Gruppi di finitura

Finishing units

Grupos de acabado

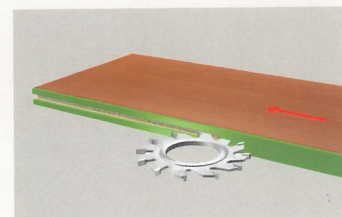
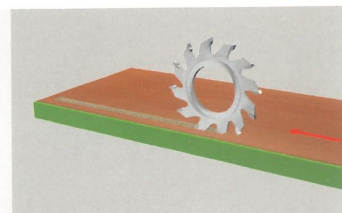
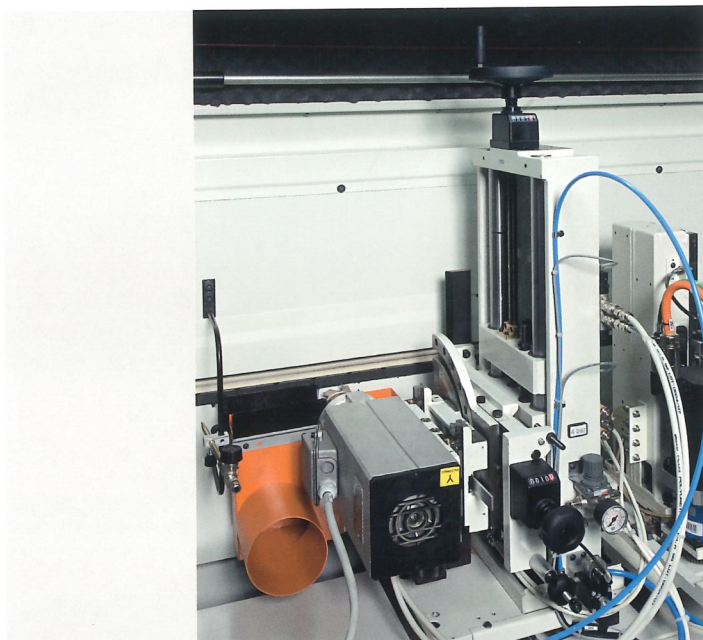

Gruppo toupie
Grooving unit
Grupo tupí para ranuras

Gruppo toupie elettronico con cambio utensili automatico

NC controlled grooving unit with automatic tool change over

Grupo tupí para ranuras electrónico con cambio herramientas automático

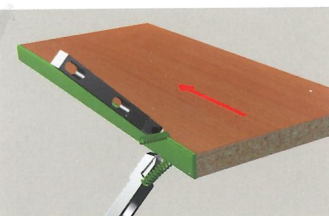
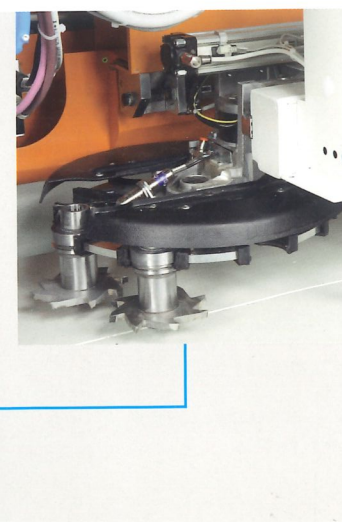
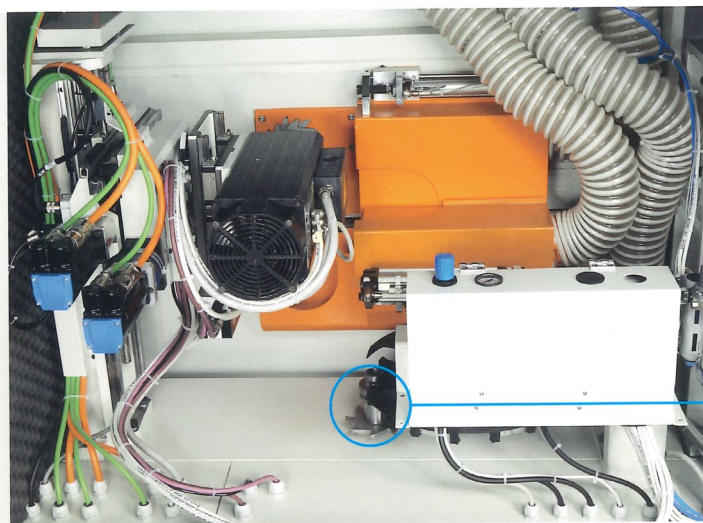

Gruppo raschiabordo
Edgescraping unit
Grupo rascador

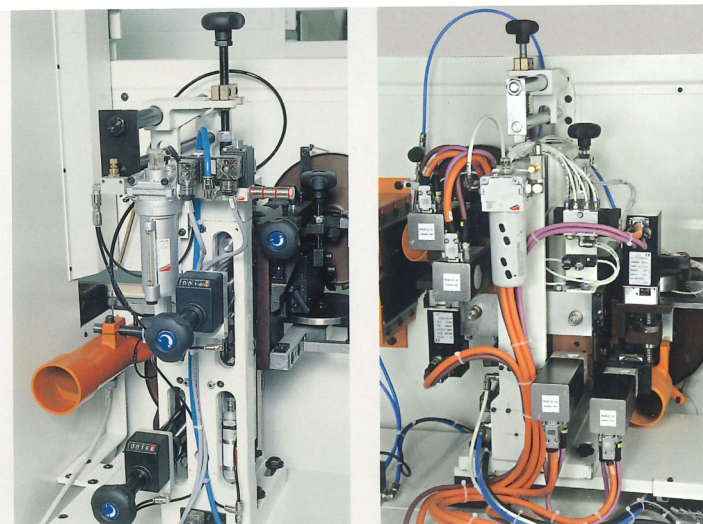

Gruppo raschiabordo multifunzione
Multifunctional edgescraping unit
Grupo rascador multifuncion

Solution

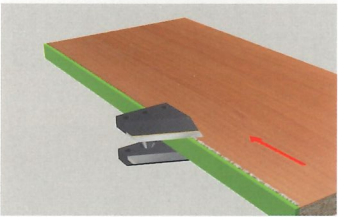

Gruppo raschiacolla
Gluescraping unit
Grupo rascacola

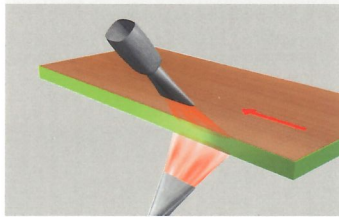
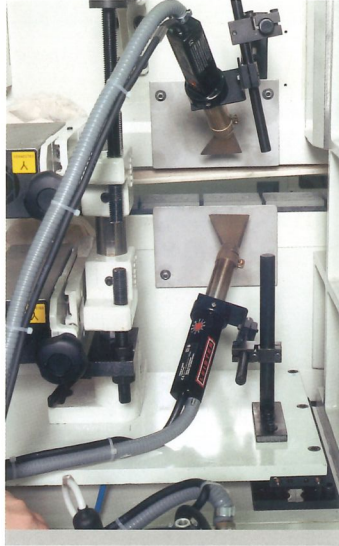

Gruppo rattivatore bordo
Edge brightening unit
Grupo avivador canto

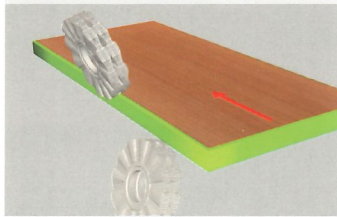
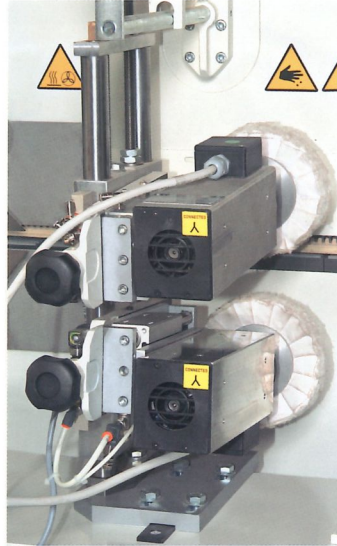

Gruppo spazzole
Buffing unit
Grupo cepillos

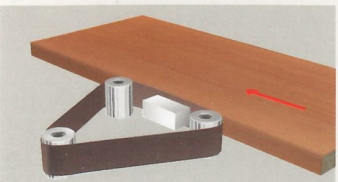
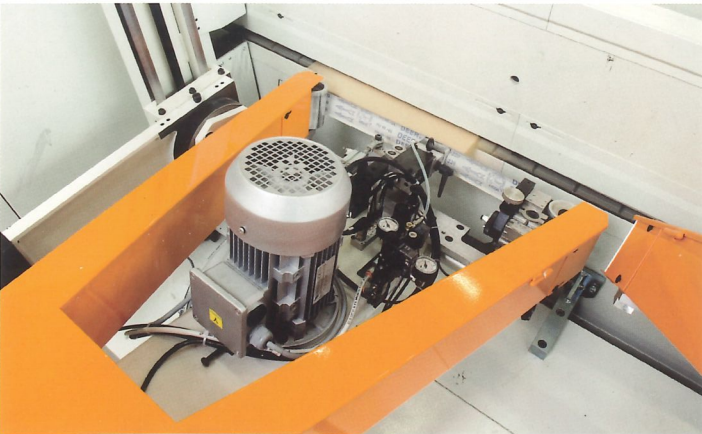

Gruppo levigatore
Sanding unit
Grupo lijador

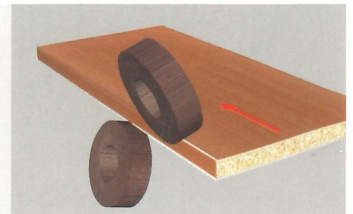
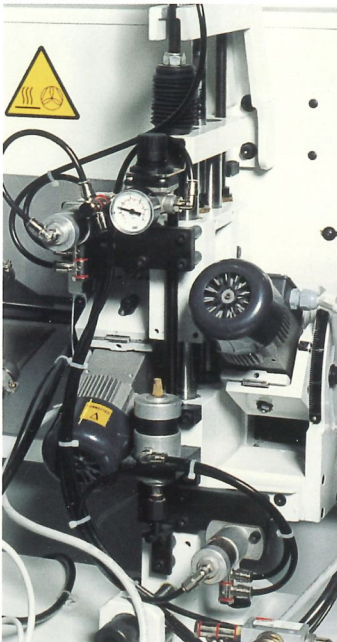

Gruppo tinteggiatore
Staining unit
Grupo coloreador

Lavorazioni softforming

Softforming processing

Trabajo softforming

Profili softforming
Softforming profiles
Perfiles softforming

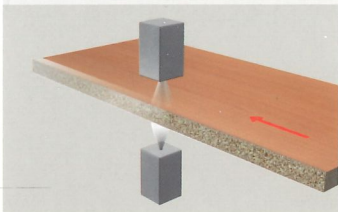
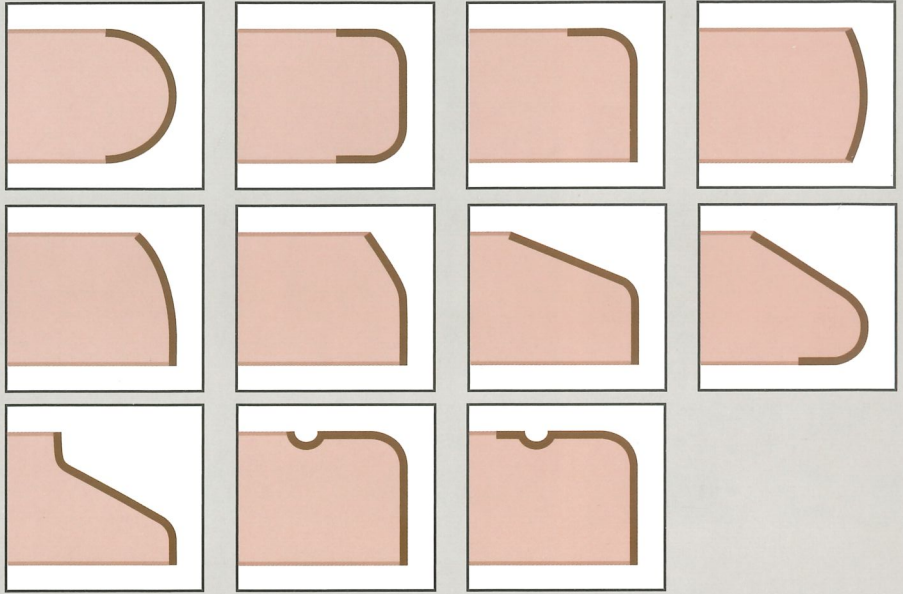

Gruppo antiadesivizzante
Anti-adhesive unit
Grupo antiadhesivo

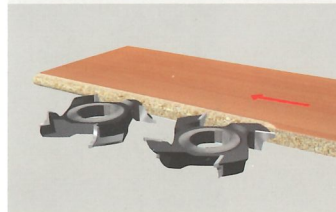

Gruppo fresatore
Milling unit
Grupo fresador

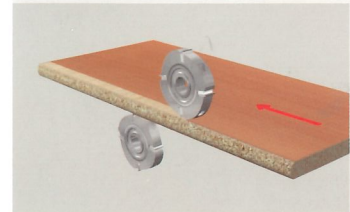
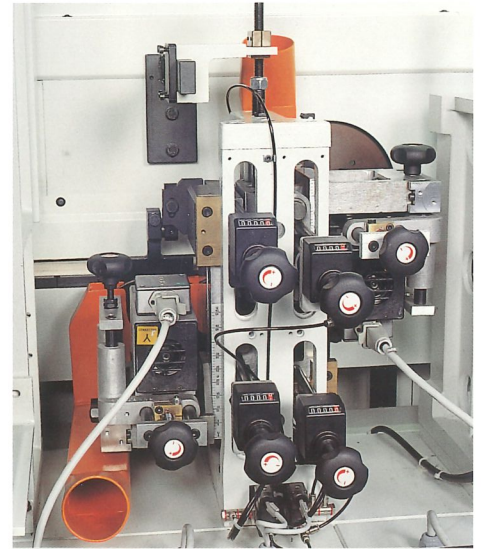

Gruppo profilatore per complanare
Inlay shaping unit
Grupo perfilador para coplanar

Solution

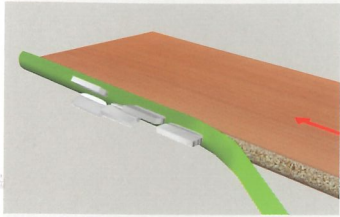

Gruppo incollaggio softforming
Softforming gluing unit
Grupo encolador softforming

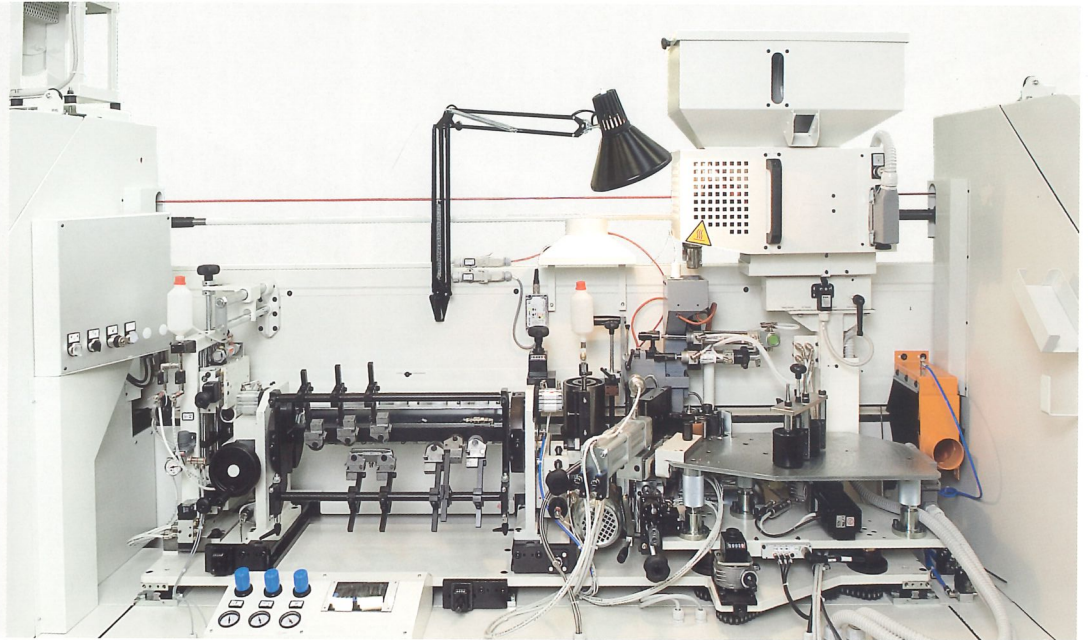

Cambio settori di pressione a revolver
Pressure sectors change over by revolver system
Cambio sectores de presión a revolver

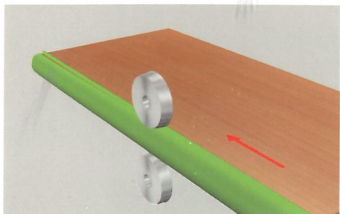
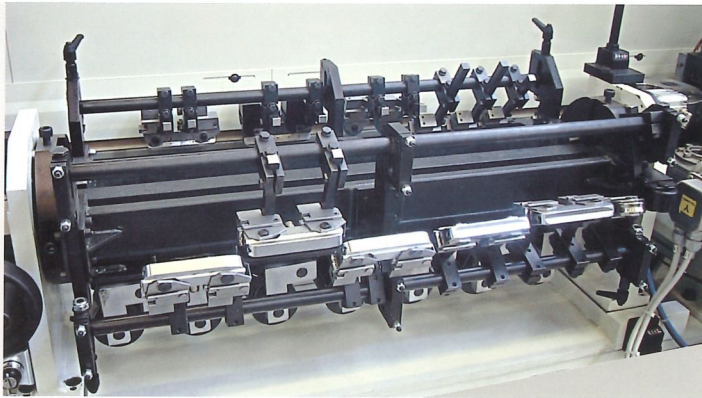

Gruppo cesoia longitudinale
Longitudinal shear unit
Grupo cizalla longitudinal

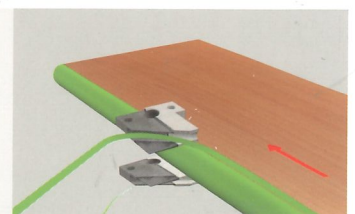
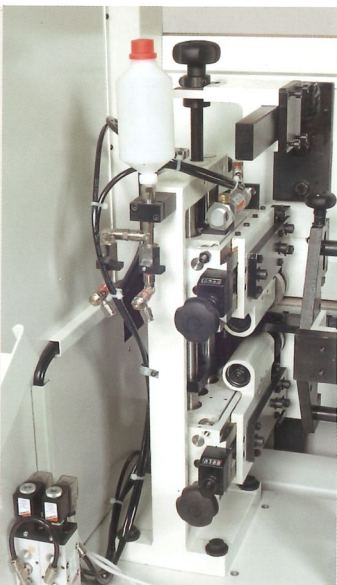

Gruppo raschiafilo
Scraping unit
Grupo rascador de aristas

Principali opzionali

Main optionals

Principales opciones

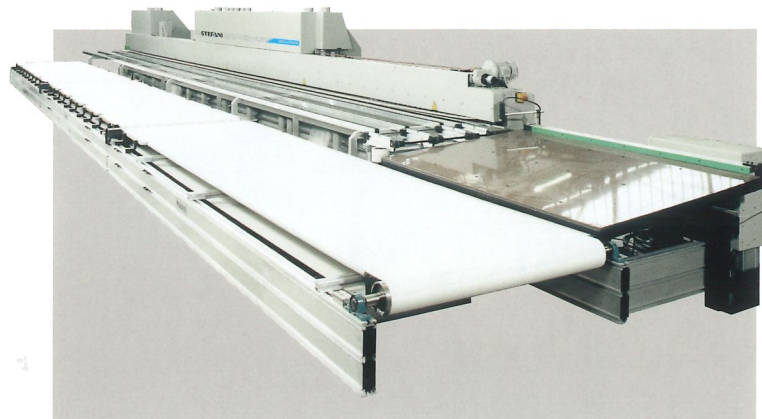

Sistema di ritorno pezzi
Panel-return system
Sistema de retorno piezas

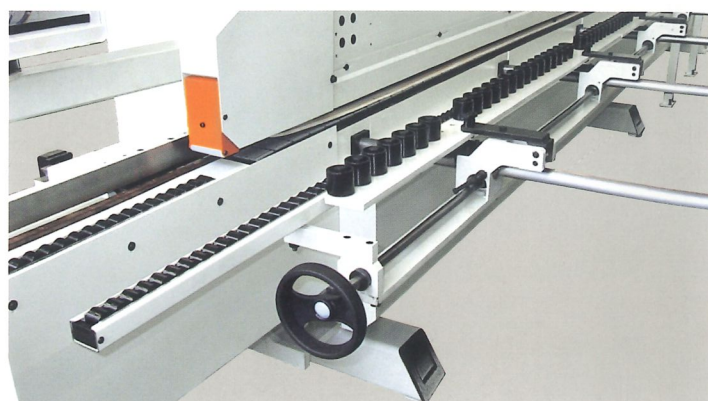

Spalla di contrasto
Counter shoulder
Sistema de contraste

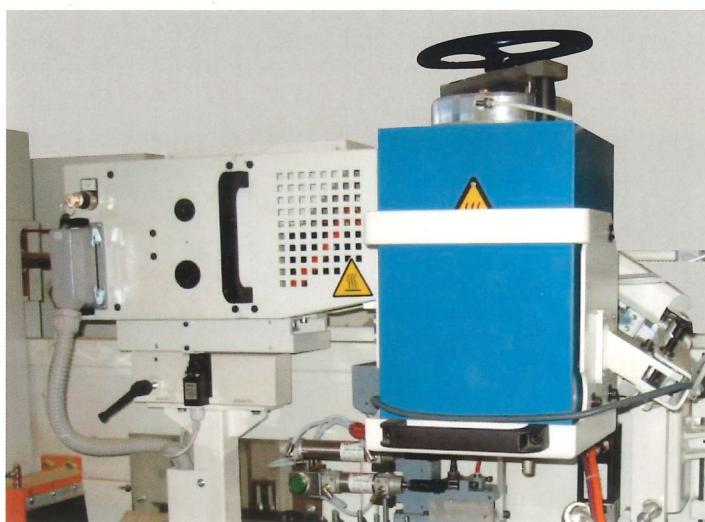

Sistema di scambio rapido tra prefusori per colla EVA e PUR
con cambio rapido vasche colla
Quick melting and glue pot change over system (EVA-PUR)
Sistema de cambio rápido entre los prefundidores
para cola EVA y PUR con cambio rápido de los tanques de cola



Lettore codice a barre
Bar code reader
Lector código de barras

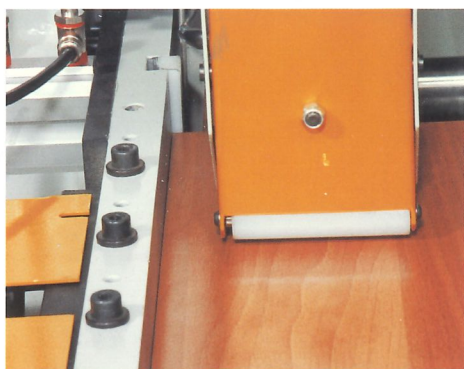

Dispositivo distanziatore pannelli
Panel spacing device
Dispositivo distanciador de paneles

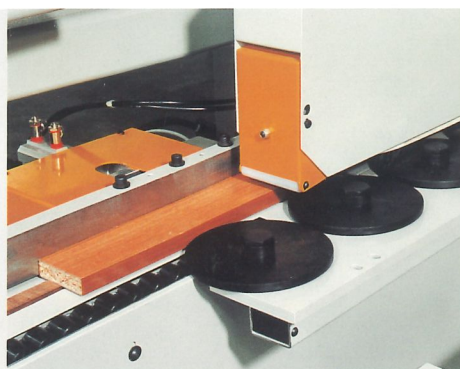

Barra a dischi per la lavorazione di pezzi
stretti
Disk-type counter pressure bar for
processing narrow pieces
Barra de discos para el trabajo de piezas
estrechas

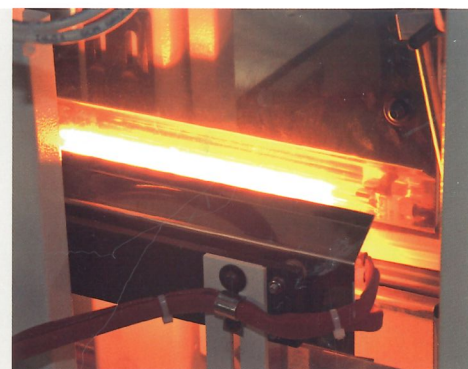

Lampade riscaldamento pannelli
Heating panels lamps
Lamparas para calentamiento

Applicazione
bordi in alluminio

Aluminium
edge processing

Aplicaciòn
de canto de aluminio

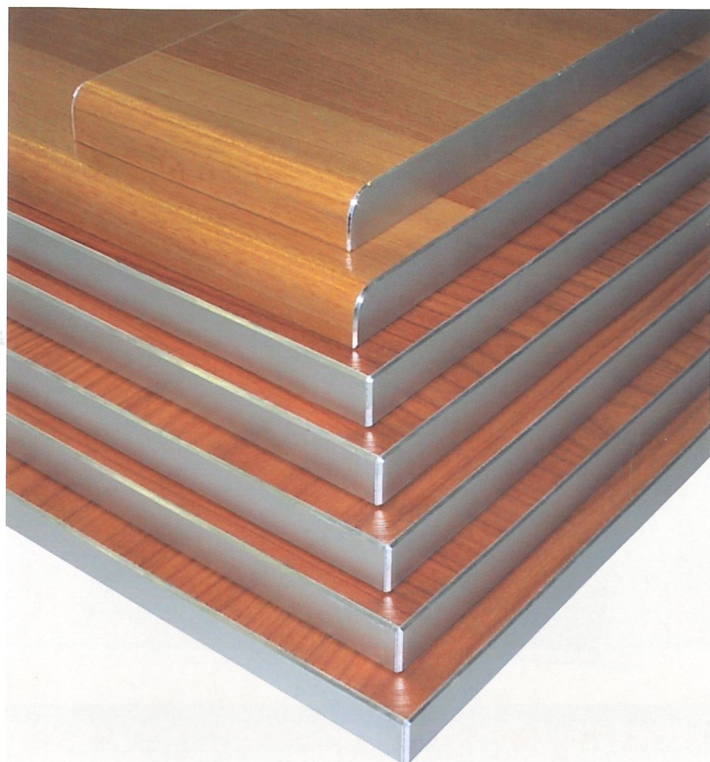

La tecnologia sviluppata da Stefani per l'applicazione e la lavorazione di bordi in alluminio non richiede levigatori e consente di ottenere una finitura sia lucida che opaca.

The technology developed by Stefani for aluminium edge processing doesn't require sanding units and allows you to obtain both shining and opaque finishing.

La tecnología desarrollada por Stefani para la aplicación y el trabajo de cantos de aluminio no pide alisadores y permite obtener un retoque tanto brillo como mate.



Kit applicazione
colla poliuretànica (PUR)
PUR glue process device
Kit aplicaciòn
cola poliuretànica (PUR)

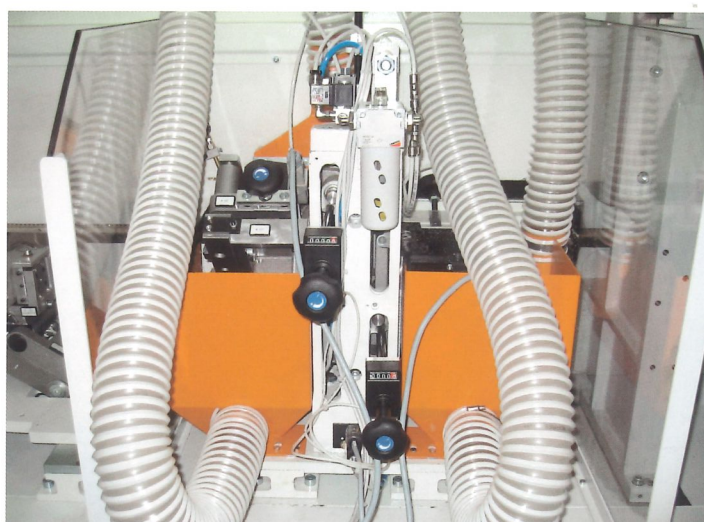

Gruppo finitore per alluminio
Finishing unit for aluminium edge
Grupo de retoque para aluminio

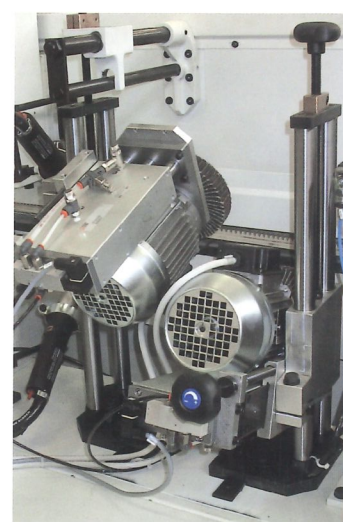

Gruppo spazzole
per alluminio
Buffing unit for
aluminium edge
Grupo cepillos para aluminio

PC Office

PC Office

PC Office

SOLUTION è dotata di **PC Office** che opera in ambiente Windows XP e consente di gestire la macchina in modo semplice, rapido e senza errori.

Solution is equipped with PC Office working in Windows XP, which allows easy, quick and precise machine management.

SOLUTION està provista de PC Office que trabaja en ambiente Windows XP y permite dirigir la màquina de manera simple, ràpida y sin errores.

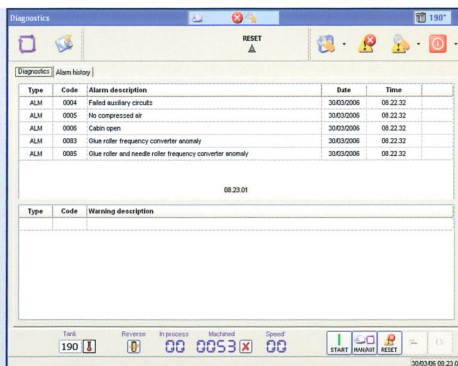
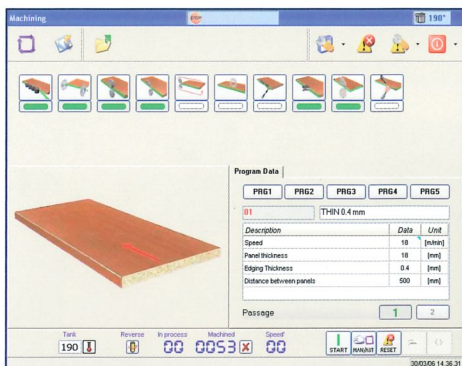

Numero illimitato di programmi di lavoro memorizzabili.
Selezione del primo o secondo passaggio senza cambio programma.
Possibilità di interfaccia touch screen.

Unlimited number of processing programmes. Selection of the first or second pass without changing the program.
Possibility of touch screen control.

Numero ilimitado de programas de trabajo memorizables. Selección de la primera y segunda pasadas sin cambio de programma.
Posibilidad de control numerico touch screen.

Gestione della diagnostica

Nel caso di stato macchina in allarme, il PC segnala i dettagli dell'allarme e visualizza la zona della macchina nella quale l'allarme si è verificato, guidando, così, il cliente alla risoluzione del guasto.

Trouble shooting

In case of machine in warning, the PC visualizes the alarm, identifies the reasons of alarm and finds out where the alarm is on the machine. Therefore the PC leads the customer to the solution of the warning.

Gestión de los diagnòsticos de errores

Si la màquina se para por una alarma, el PC señala los detalles de las alarmas y visualiza la zona de la màquina en la que hay la alarma, conduciendo, así, al cliente hasta la resolución de la falla.

Report di produzione

Programmi di lavorazione, pannelli lavorati, bordo utilizzato, con definizione giornaliera, mensile e annuale. I report di produzione permettono di tenere sotto controllo l'andamento della produzione, in modo statistico con grafici o con semplici fogli Excel.

Production reports

Processing data, worked panels, used edge, daily, monthly and yearly. Reports allow production monitoring by statistic graphics and Excel files.

Report de producció

Programas de trabajo, tableros trabajados, canto empleado, con definición cotidiana, mensual y anual. Los reportes de producción permiten controlar el desarrollo de la producción, de manera estadística con gráficos o con hojas de Excel sencillas.

Interfaccia
ufficio-macchina

Office-machine
interface

Interfaz
oficina-màquina

Reparto produzione
Workshop
Seccìon produccìon

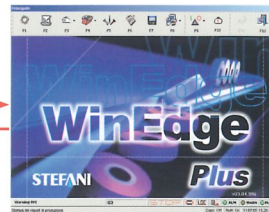
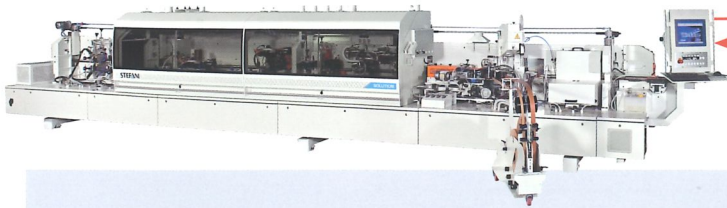

Ufficio
Office
Oficina

Attraverso il PC Office è possibile programmare la macchina direttamente dall'ufficio e ricevere dalla macchina i report di produzione.

Through the PC Office it's possible to program the machine directly from the office and to receive production reports directly from the machine.

Por medio del PC Office es posible programar la màquina directamente desde la oficina y recibir desde la màquina los reportes de produccìon.

Teleassistenza

Teleservice

Teleasistencia

Azienda cliente
Customer premises
Empresa cliente



Assistenza STEFANI
STEFANI after sales
department
Asistencia STEFANI

Con il servizio di teleassistenza (opzionale) viene assicurato al cliente un immediato intervento da parte dei tecnici STEFANI nelle situazioni di allarmi o errori durante il funzionamento della macchina. Alla richiesta di intervento da parte del cliente, i tecnici STEFANI si collegano via modem al PC della macchina situata nello stabilimento cliente e, in tempo reale, effettuano operazioni sul software per riportare la macchina in condizioni ottimali. Tramite teleassistenza, inoltre, è possibile realizzare modifiche o aggiornamenti dei programmi su richiesta dal cliente.

Through teleservice (optional) is assured to the customer an immediate intervention from STEFANI technicians in situation of warnings during the machine process. Further to the request of intervention about the customer, STEFANI technicians will connect by modem to the PC situated on the customer machine and, in real time, they will resolve the software problems and re-set the machine in the best conditions. Besides, thought teleservice it's possible to modify or update the programs according to customer requests.

Con el servicio de teleasistencia (opciòn) se asegura al cliente una inmediata intervenciòn por parte de los tècnicos STEFANI en las situaciones de alarmas o errores durante el funcionamiento de la màquina. Con el pedido de intervenciòn por el cliente, los tècnicos STEFANI se conectan via modem al PC de la màquina situada en la fàbrica del cliente y, en tiempo real, efectuan operaciones sobre el software para volver la màquina a las condiciones optimas. Por medio de teleasistencia, ademàs, es posible realizar modificaciones o reajuste de los programas sobre pedido por el cliente.

Dati tecnici

Technical specifications

Características técnicas

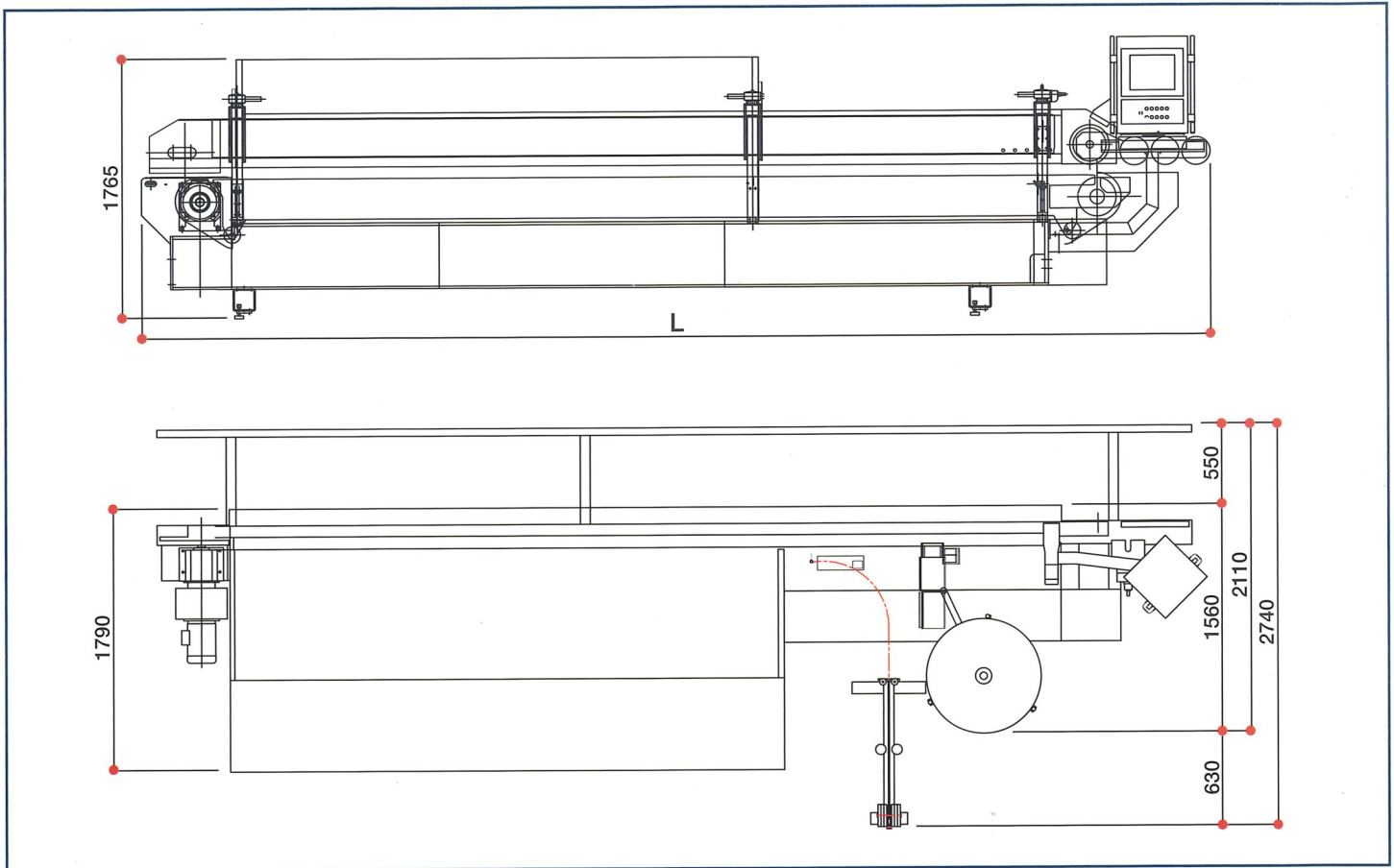

Solution	Solution R-47	Solution R-54	Solution R-60	Solution R-67	Solution R-73	Solution 47	Solution 54	Solution 60
Lunghezza totale (L) mm Total length (L) mm Longitud total (L) mm	5650	6350	6950	7650	8250	5650	6350	6950

Solution	Solution 67	Solution 73	Solution 80	Solution 86	Solution 93	Solution 99	Solution 106	Solution 112
Lunghezza totale (L) mm Total length (L) mm Longitud total (L) mm	7650	8250	8950	9550	10250	10850	11550	12150

Spessore minimo e massimo del bordo in rotolo Minimum and maximum coil material thickness	Espesor mínimo y máximo del canto en rollos	0,4 - 3 mm
Spessore minimo e massimo del bordo in striscia Minimum and maximum strip material thickness	Espesor mínimo y máximo del canto en tiras	0,4 - 25 mm
Spessore minimo e massimo del pannello Minimum and maximum panel thickness	Espesor mínimo y máximo del panel	10 - 60 mm
Velocità di avanzamento Feed speed	Velocidad de avance	10-25 m/min (opt. 12-30 m/min)

SINCERT



STEFANI

I dati tecnici possono variare in funzione della composizione scelta. Per esigenze dimostrative alcune foto riproducono macchine complete di accessori. Senza nessun preavviso i dati tecnici possono essere modificati, le modifiche non influenzano la sicurezza prevista dalle norme CE.

Technical specifications may vary according to the composition chosen. For demonstration purposes, several photographs show machines complete with accessories. The technical data can be modified without advance notice, the modifications do not influence the safety prescribed by the CE regulations.

Los datos técnicos pueden variar en función de la composición elegida. En este catalogo las máquinas han sido representadas con algunos accesorios. La empresa se reserva el derecho de modificar los datos y las medias sin previo aviso sin influir en la seguridad prevista de la certificación CE.

STEFANI:
scelta da clienti
esigenti

STEFANI:
The choice of
demanding customers

STEFANI:
elegida por
clientes exigentes



Oltre cinquant'anni di esperienza nel settore delle macchine per la lavorazione del legno, migliaia di bordatrici e squadrabordatrici operanti in tutto il mondo, hanno reso il marchio STEFANI uno dei più conosciuti ed apprezzati a livello internazionale, sinonimo di innovazione tecnologica, affidabilità, elevati standard qualitativi.

STEFANI è il partner ideale per la grande azienda del mobile che richiede macchine ed impianti ad elevata capacità produttiva.

Over fifty years' experience in the woodworking machinery industry, thousands of edgebanding and squaring-edgebanding machines sold throughout the world, have made the STEFANI name one of the most well-known and esteemed at international level.

A brand synonymous with technical innovation, reliability and high quality standards, STEFANI is the ideal partner for large-scale furniture makers who require machines and systems with high output capacities.

Más de cincuenta años de experiencia en el sector de las máquinas para la elaboración de la madera, miles de chapeadoras y escuadradoras-chapeadoras en función en todo el mundo han hecho de la marca STEFANI una de las más conocidas y apreciadas a nivel internacional, sinónimo de innovación tecnológica, fiabilidad, estándar de calidad elevados.

STEFANI es el soporte ideal de la grande empresa de muebles que necesita máquinas e instalaciones con una alta capacidad productiva.

STEFANI

STEFANI

SCM GROUP spa - Via del Lavoro, 1/3 - PO Box 168 - 36016 Thiene (VI) - Italy
Tel. +39/0445/359511 - Fax +39/0445/359599 - www.scmgroup.com - stefani@scmgroup.com