

Powermat 1500

Give your business a new perspective

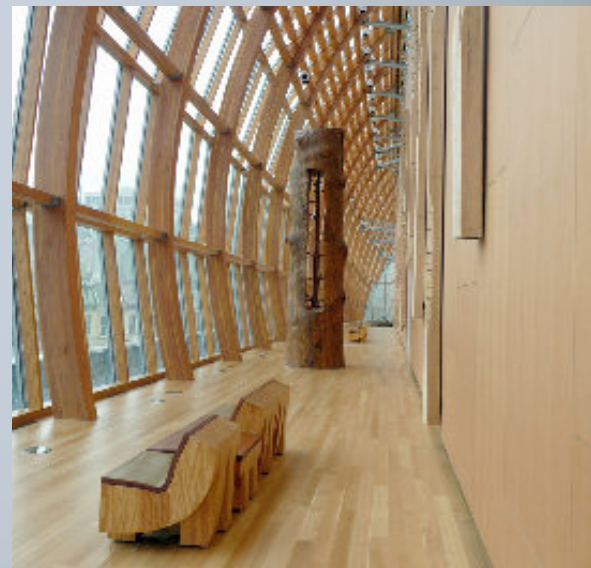

WEINIG



WEINIG offers more

Whoever buys a WEINIG machine today knows that they are optimally equipped for the future of their business.

100% quality – WEINIG machines must satisfy the highest standards. That is why the greatest care in development and manufacturing is a traditional virtue at WEINIG. You benefit from this by the long service life of your valuable investment.

Reliability – The availability of a machine determines how profitable your business is. WEINIG systems are known for their high standard. More than 80,000 machines from WEINIG are operating around the globe to the utmost satisfaction of our customers.

Expert advice – Whether you need the expertise of WEINIG Concept for turn-key solutions or the know-how of a WEINIG expert at your door – you can always rely on our committed sales team. Ultimately you will have a customized solution that offers you maximum value for your investment.

Everything from a single source – With WEINIG you have an experienced full service provider as your partner. From rough cutting to stacking, from a stand-alone machine to a fully automated turnkey production line. Including, of course, a comprehensive service package.

Service – Safety is reassuring. If worse comes to worst, our trained service engineers will be quickly on site. WEINIG maintains a unique closely woven service network worldwide. A mesh so fine that no customer can fall through!

The WEINIG ExpoCenter

In our ExpoCenter we can show you what top technology can really do for you. Here you can experience our machines in action.



Quality begins with the moulder:
The new Powermat 1500

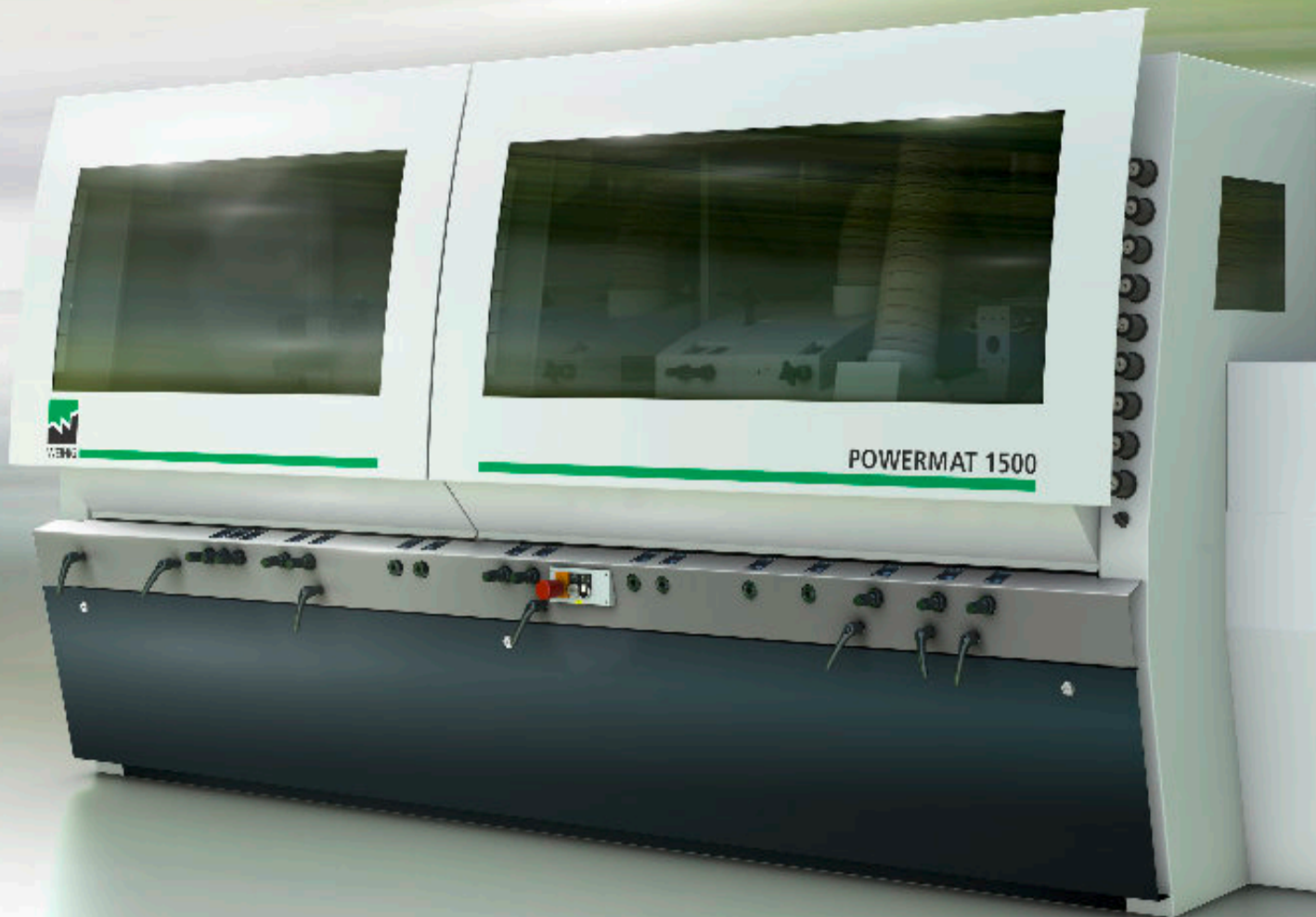



Ultimate design, perfect processing down to the last detail, typical WEINIG: with the Powermat 1500 you will experience the full capability of a WEINIG moulder.

With this exceptional state of the art machine standard the Powermat 1500 offers outstanding ease of use and a maximum of profitability. Decades of experience have influenced the development of this machine. Supplemented by useful extras the Powermat 1500 can be perfectly adapted to your individual needs. The result: a machine coping even with challenging applications and delivering top quality.

The extraordinary standards of the Powermat

With the Powermat 1500 WEINIG offers an exceptional machine as a standard model: behind every high performance machine there must be a design concept that puts you in a leading position to control costs, guaranty scheduled delivery times and cater to your customers' wishes. WEINIG's innovative technology ensures that machine setup times are shortened, reject rates are reduced and process reliability is guaranteed throughout.

From the high quality cast iron frame to intuitive and safe operation: the latest technology, flexibility and a wide range of capabilities make the Powermat 1500 to a machine that suits nearly every modern production facility. Add top profitability, high resale value and the legendary WEINIG surface quality to make a perfect choice.

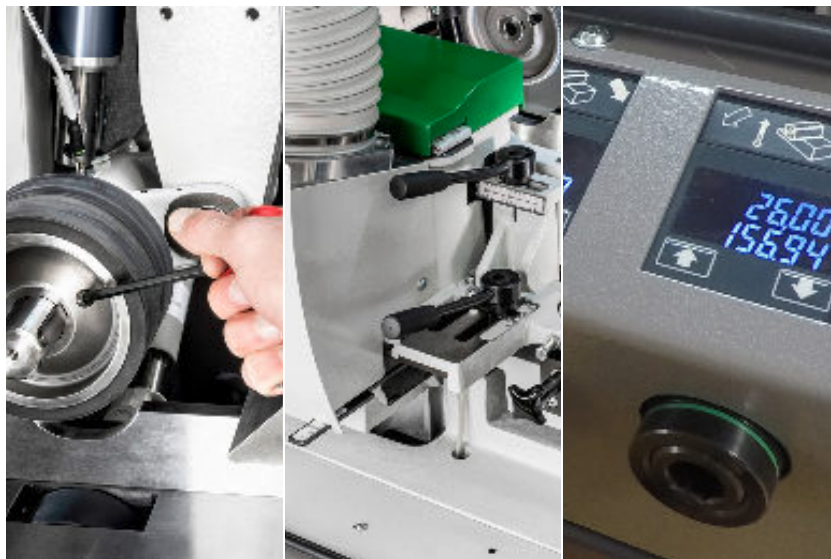

The new operating concept

Comfort Set comprises a great number of wrench-free adjustments for pressure and guiding elements which can be performed quickly, accurately and without error. Rulers as well as easy to read electronic digital readouts and quick adjustments are part of this. With features like this the machine operator will experience a new degree of comfort in performing the moulder setup like he never experienced before. The final proof of the new setup procedure can also be seen in the quality of the products you produce.

1. Outstanding performance

With 7,000 rpm spindle speed the new Powermat offers even more performance. This means more linear production every day without sacrificing high surface quality.

2. Efficient dust extraction

The new dust extraction system leads to an optimized control of wood chips. This minimizes dent marks on the finished surface and the noise level decreases. In addition, the required air velocity is reduced as well.

3. Intuitive machine control

With the help of Memory Plus it is possible to perform dimensional or profile changes in the wink of an eye. All settings can be stored for perfect repetition of the product at a later date.

4. Excellent ease of operation

With the Comfort Set operating concept you have all trump cards in one hand: optimal accessibility and comfortable machine setting ensure safe and fast setup with high quality results.

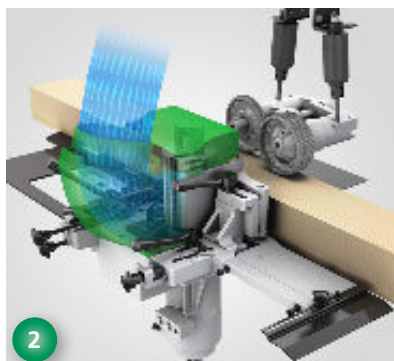
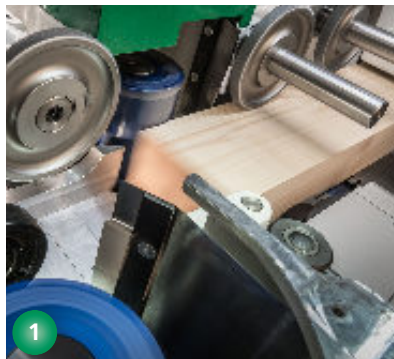

Useful options: More for your success!

WEINIG innovations have driven solid wood processing forward and set new benchmarks time and again. The new Powermat 1500 continues the tradition – to make your day-to-day work operations simpler, more productive and more profitable. With plenty of useful extras the Powermat 1500 can be adapted to your individual requirements. The scope of applications even goes beyond the processing of solid wood only.

WEINIG production technology is perfectly adapted to individual circumstances such as market situation, batch sizes and work flow procedures. From us you receive a solution that offers maximum return on investment. As a full service provider, we can also give you a total package so that you can organize the machine environment perfectly. From job preparation to the finished quality product.

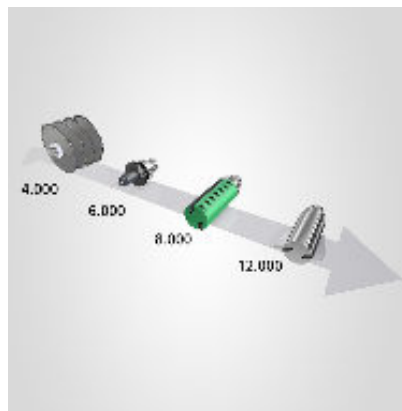

We perfectly gear the spindle speed to your application and your performance requirement in the range from 4,000 rpm to 12,000 rpm.

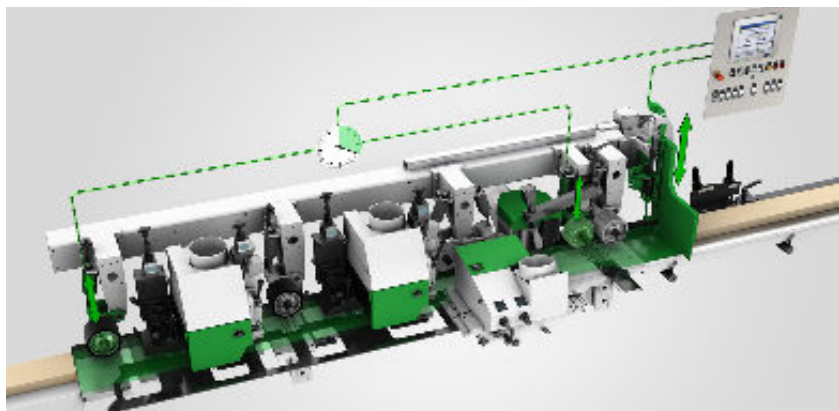

The workpiece monitoring automatically detects whether there is a workpiece inside the machine or not. This allows dimensional changes while the machine is running. You benefit from simple operating and time savings.



Extremely high performance yet surprisingly simple. Whether spindle related data, service checks or tool measurements PowerCom is the top solution for networking your Powermat 1500.

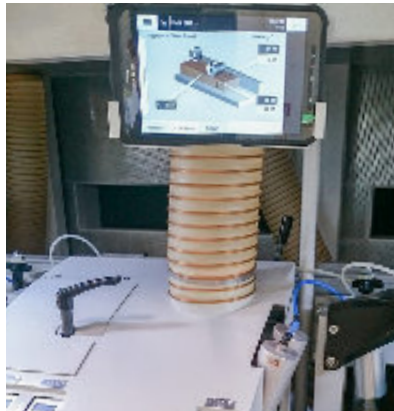

SmartTouch offers the display of setup information on a mobile tablet in addition to the main control unit. In this manner the operator has all relevant setup information in full view at the location where needed.

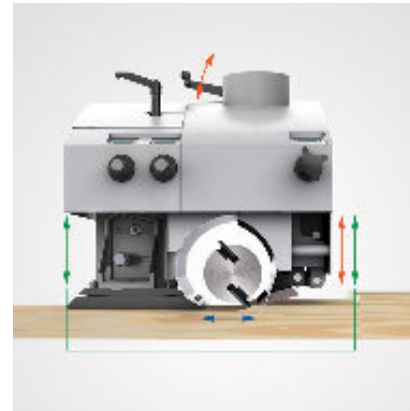

Pressure elements and extraction hood can be adjusted very simply to suit the cutting circle of each tool. This guarantees a comfortable setup and sure guiding of the workpieces.

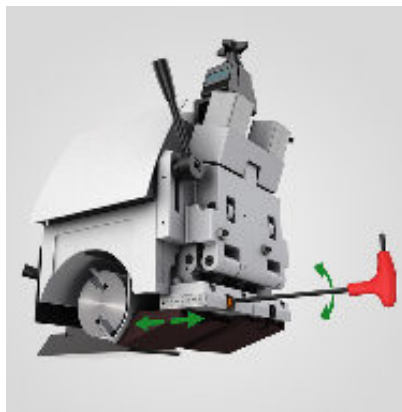

The chip breaker in front of the top spindle pivots away from the tool to avoid a collision. Due to the EasySet adjustment the chip breaker can be adjusted very simply to the tool cutting circle.



The top pressure roller opposite the left spindle only needs to be adjusted to the tool cutting circle once. When changing the width of the workpiece, the roller moves with the left spindle!



With the Powermat 1500 you can produce textured surfaces on mouldings with an attractive design. The possibilities of ornamental mouldings with irregular surfaces are almost unlimited.

WEINIG System Plus: The shortest way from an idea to the finished product

The WEINIG System Plus enhances your Powermat 1500 to become a highly efficient machining center that raises productivity. The individual system modules fit together like building blocks to produce the perfect result.

Particularly, when confronted with the challenges of quick delivery times, short production runs and satisfying individual customer requirements, WEINIG shows its competence – not only in reference to machine technology but also in consideration of the complete production infrastructure. From the profile drawing to the setup of your moulder. With the WEINIG System Plus you will meet the daily challenges with ease.

Ideal for companies with

- large variety of profiles
- frequent profile changes
- single order processing
- multiple machines
- in-house tool grinding

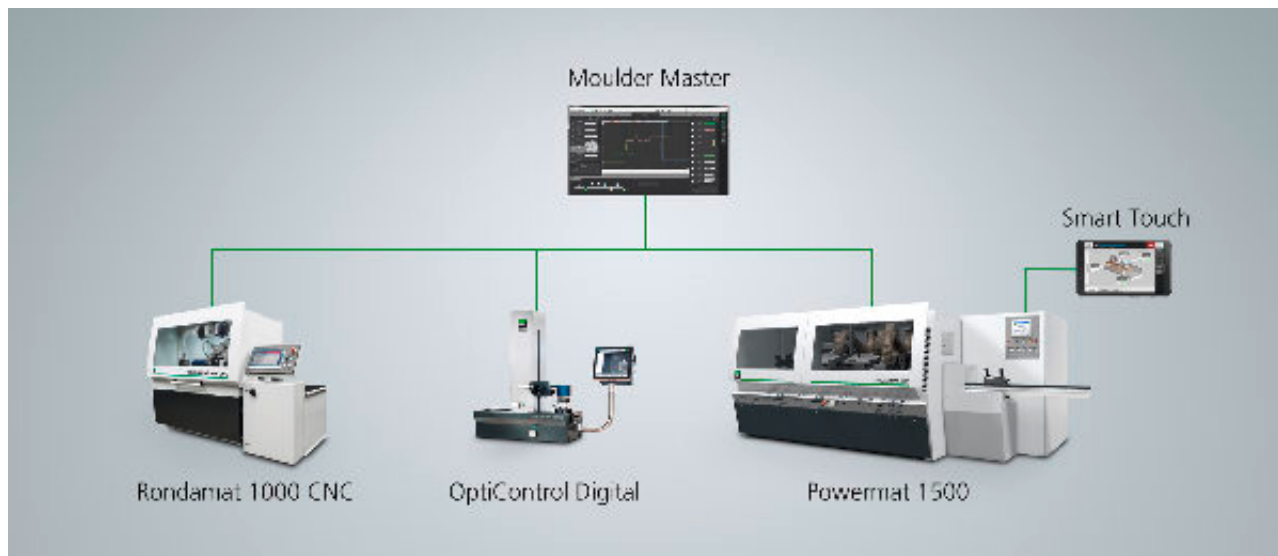

Original WEINIG Tools: Your guaranty for perfect workpieces

The best machine only works as well as the tool it is equipped with. A high quality WEINIG moulder in combination with a precision tool produce top quality and performance. WEINIG offers you all the tools that are used for planing and profiling:

- PowerLock tools
- Hydro clamping
- Conventional tools

The Rondamat Series is our knife grinder for extreme precision in knife production. With the Rondamat you are able to manufacture and regrind profile and planer knives for any desired profile. Fast, exact and reasonably priced.

Tool measuring and display systems complete our tool grinding systems. This complete solution guarantees you the highest profile precision and at the same time enormous savings in set-up time.



Technical data

WEINIG planers and moulders offer a variety of spindle configurations. This means that they can be specified perfectly to your particular application. The spindle sequences illustrated do not, by any means, cover all possibilities offered by our flexible modular frame system. Your WEINIG expert will be happy to advise you.

Please note: The dimensions given here are the values for a standard machine. Other measurements can result depending on options or alternative position of the control cabinet.

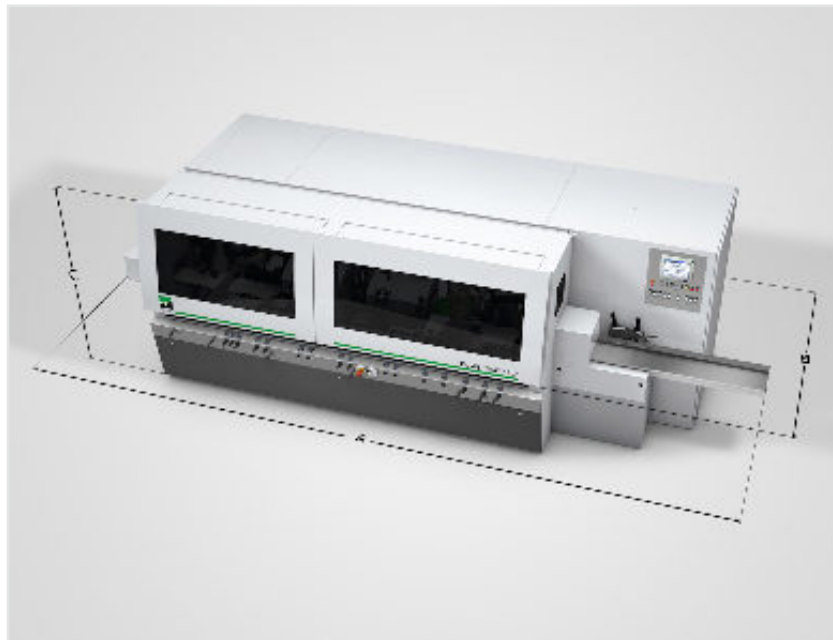

017
A = 4,100 mm (161.4"), B = 2,165 mm (85.2"),
C = 1,905 mm (75")



018
A = 4,790 mm (188.6"), B = 2,165 mm (85.2"),
C = 1,905 mm (75")

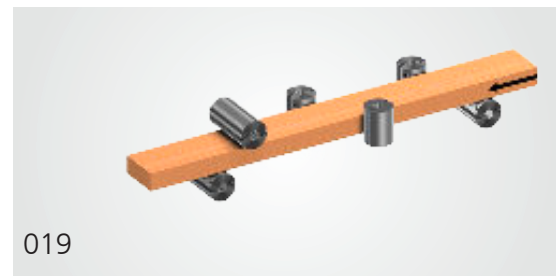

019
A = 4,570 mm (179.9"), B = 2,165 mm (85.2"),
C = 1,905 mm (75")

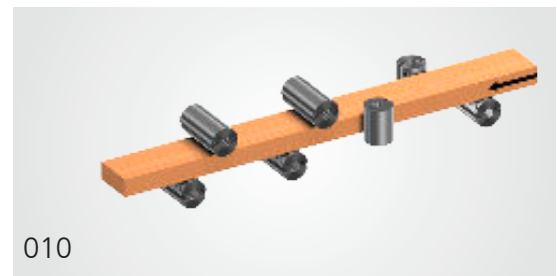

010
A = 4,880 mm (192.1"), B = 2,165 mm (85.2"),
C = 1,905 mm (75")



A = 5,840 mm (229.9"), B = 2,165 mm (85.2"),
C = 1,905 mm (75")

026



A = 850 mm (33.46"), B = 2,165 mm (85.2"),
C = 1,905 mm (75")

Universal spindle

A useful addition for the production of complex profiles in one pass. Flexible working positions on all 4 sides.



A = 5,060 mm (199.2"), B = 2,165 mm (85.2"),
C = 1,905 mm (75")

027

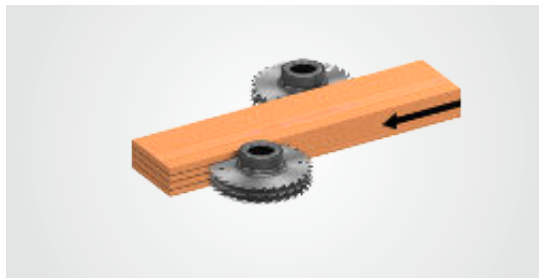

A = 1,000 mm (39.37"), B = 2,165 mm (85.2"),
C = 1,905 mm (75")

Vertical spindle splitting unit

Planing and splitting in one process ensures top performance in production.



A = 5,350 mm (210.6"), B = 2,165 mm (85.2"),
C = 1,905 mm (75")

013

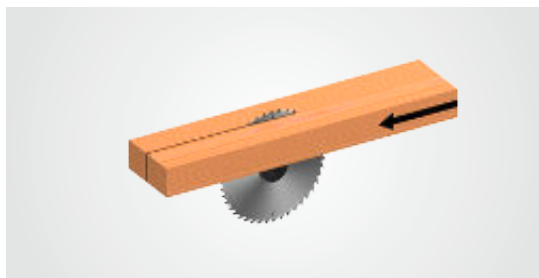

A = 870 mm (34.25"), B = 2,165 mm (85.2"),
C = 1,905 mm (75")

Horizontal spindle splitting unit

The horizontal splitting unit adds the benefit of integrating a multi-blade rip saw into one process.

Standard models and options

Working height min./max.	10/160 mm (0.39" - 6.29")
Working width min./max.	20/230 mm (0.78" - 9.05")
260 mm (10.23") working width	○
310 mm (12.20") working width without outboard bearing in combination with PowerLock	○
200 mm (7.87") working height	○
7,000 rpm (first bottom 6,000 rpm)	●
8,000 rpm	○
12,000 rpm	○
Operating concept Comfort Set	●
Memory Plus	●
PowerCom Plus	○
Electronic read-outs on spindle adjustments, chip breakers and pressure shoes	●
CNC-controlled adjustments for spindle axes and feed beam	○
Receding chip breaker, spring-mounted	●
Max. horizontal tool diameter (except first bottom)	225 mm (8.85")
Max. vertical tool diameter	200 mm (7.87")
PowerLock tool holders	○
Universal spindles	○
Frequency-controlled feed speed (standard)	5 - 40 m/min (16.4 - 131 FPM)
MarathonCoating for machine tables	○
Max. motor power on vertical spindle (standard – option)	5.5 - 15 kW (7.5 - 20 HP)
Max. motor power on horizontal spindle (standard – option)	5.5 - 37 kW (7.5 - 50 HP)
Improved sound enclosure	○

Subject to technical alterations. The statements and pictures provided in this brochure also include optional equipment that is not included in standard delivery. Some protective covers were removed for photographing.

● Standard ○ Option

You can expect big things from us: WEINIG – Your partner for the future

We are here for you.

Comprehensive advice – for example on optimum process integration of your new Powermat – is standard service at WEINIG as well as a well-tested training plan with effective training sessions. Our branches in all four corners of the earth and an extensive service team guaranty rapid help where and when you need us. As you see: WEINIG offers more.



Production line



Advice

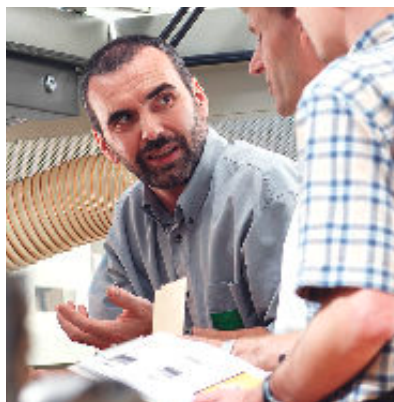

Training



Service

MICHAEL WEINIG AG

Product Unit Profiling

Weinigstraße 2/4 · 97941 Tauberbischofsheim · Germany
Phone +49 9341 86-0 · Fax +49 9341 7080
info-profiling@weinig.com · www.weinig.com

