

# Powermat

## 2400





# Powermat

## 2400

### **With wood into the future**

Solid wood processing with WEINIG 4

### **The whole range**

Planing and profiling in WEINIG quality 8

### **The Powermat 2400**

Highly productive, flexible and profitable 14

### **The added value concept**

The right option for every application 28

### **The whole package must be right**

Organizing, controlling and securing processes 50

### **The Powermat 2400 in facts and figures**

Technology, standards and options 56



# With wood into the future

The natural feel and noble look of wooden products makes them very desirable. This renewable, eco-friendly raw material is highly valued in society. Good times for woodworkers. Good times for you.

The increasing importance of wood is characterized by an ever growing field of application: Traditional fields of activity such as interior fittings, commercial furnishings and window manufacturing have been joined by imposing wooden architecture. Sophisticated façade and bridge constructions, glulam or cross laminated timber elements are enjoying increasing use in construction. Textured surfaces and creative lightweight construction are setting popular trends.

As a company active in this industry, you can benefit from this development towards increased use of wood, the only CO<sub>2</sub>-neutral material. You can also choose sustainable technology when it comes to production machinery. WEINIG is the only manufacturer who is fully committed to solid wood processing. With passion and dedication, like yourself. The ideal partner for innovative concepts to help you conquer tomorrow's market. WEINIG's machines have an especially long service life and offer exceptional reliability. An investment in WEINIG's production technology has long-term benefits and means security for your company. Very short set-up times and maximum material yield are built into every solution. Naturally with perfect accuracy of dimensions and excellent surface quality for your products.

Planing, profiling, finishing. Whatever you do – you will always make the right choice with machines from WEINIG.





# WEINIG offers more

WEINIG's successful path in wood processing is characterized by listening to our customers and the demands of the market place. Born from many years of experience, WEINIG's R & D department never fails to create new practical solutions for industry and small businesses in close collaboration with our customers. Whoever buys a WEINIG machine today knows that they are optimally equipped for the future of their business.

**100% quality** – WEINIG machines must satisfy the highest standards. That is why the greatest care in development and manufacturing is a traditional virtue at WEINIG. You benefit from this by the long service life of your valuable investment.

**Reliability** – The availability of a machine determines how profitable your business is. WEINIG systems are known for their high standard. More than 80,000 machines from WEINIG are operating around the globe to the utmost satisfaction of our customers.

**Expert advice** – Whether you need the expertise of WEINIG Concept for turn-key solutions or the know-how of a WEINIG expert at your door – you can always rely on our committed sales team. Ultimately you will have a customized solution that offers you maximum value for your investment.

**Everything from a single source** – With WEINIG you have an experienced full service provider as your partner. From rough cutting to stacking, from a stand-alone machine to a fully automated turnkey production line. Including, of course, a comprehensive service package.

**Service** – Safety is reassuring. If worse comes to worst, our trained service engineers will be quickly on site. WEINIG maintains a unique closely woven service network worldwide. A mesh so fine that no customer can fall through!

## The WEINIG ExpoCenter

In our ExpoCenter we can show you what top technology can really do for you. Here you can experience our machines in action.







Give your business  
a new perspective...



# ...with an intelligent machine concept

The variety of products in industrial series production is immense. However, no matter which market you are servicing, you will always have the right machine concept in the Powermat 2400. The Powermat 2400 offers you both a high-performance platform for the demanding requirements of everyday multiple shift operation as well as great flexibility. This is assured by a modular system with a wide range of aggregates, tools and feed speed solutions. Whether

**Solid wood parquet –** profiles at feed speeds of up to 100 m/min

**Floor boards –** PowerLock tools rotating at 8,000 rpm are used

**WPC boards –** are planed smooth on top and bottom surfaces using PowerLock tools with carbide knives

**T&G paneling –** feeds of 100 m/min, PowerLock tools rotate at 10,000 rpm, jointed, HSS knives

**MDF strips –** feeds of 100 m/min, PCD tools, speed 12,000 rpm

**Cornices –** at a feed of 100 m/min, PowerLock Dual cutterhead with 8 knives

**Skirting boards in double width –** PowerLock tools jointed at 10,000 rpm

planing beams at 10 m/min or producing mouldings at 100 m/min; whether 4,000 rpm or up to 12,000 rpm – we can build the ideal Powermat 2400 for your requirements. So that your production is always cost-effective and in the legendary WEINIG quality. The Powermat 2400 is truly state-of-the-art technology in profiling. Here are just some examples of the vast range of applications.



**Window parts** – PowerLock tools rotate at 8,000 rpm for perfect surfaces

**Strips with T-groove** – milled with router attachment at 12,000 rpm

**Furniture parts with 3D surface structuring** – created with PowerLock tool

**Handrails** – profiled with PowerLock tools at 12,000 rpm

**Solid wood beams** – chamfered, PowerLock tools, working width 310 mm without outboard bearing

**Picture frame mouldings** – tools at 10,000 rpm, jointed, 4 knives in carbide version

**Boards** – planed smooth on 4 sides, hydro tool with 6 knives, jointed, outboard bearing



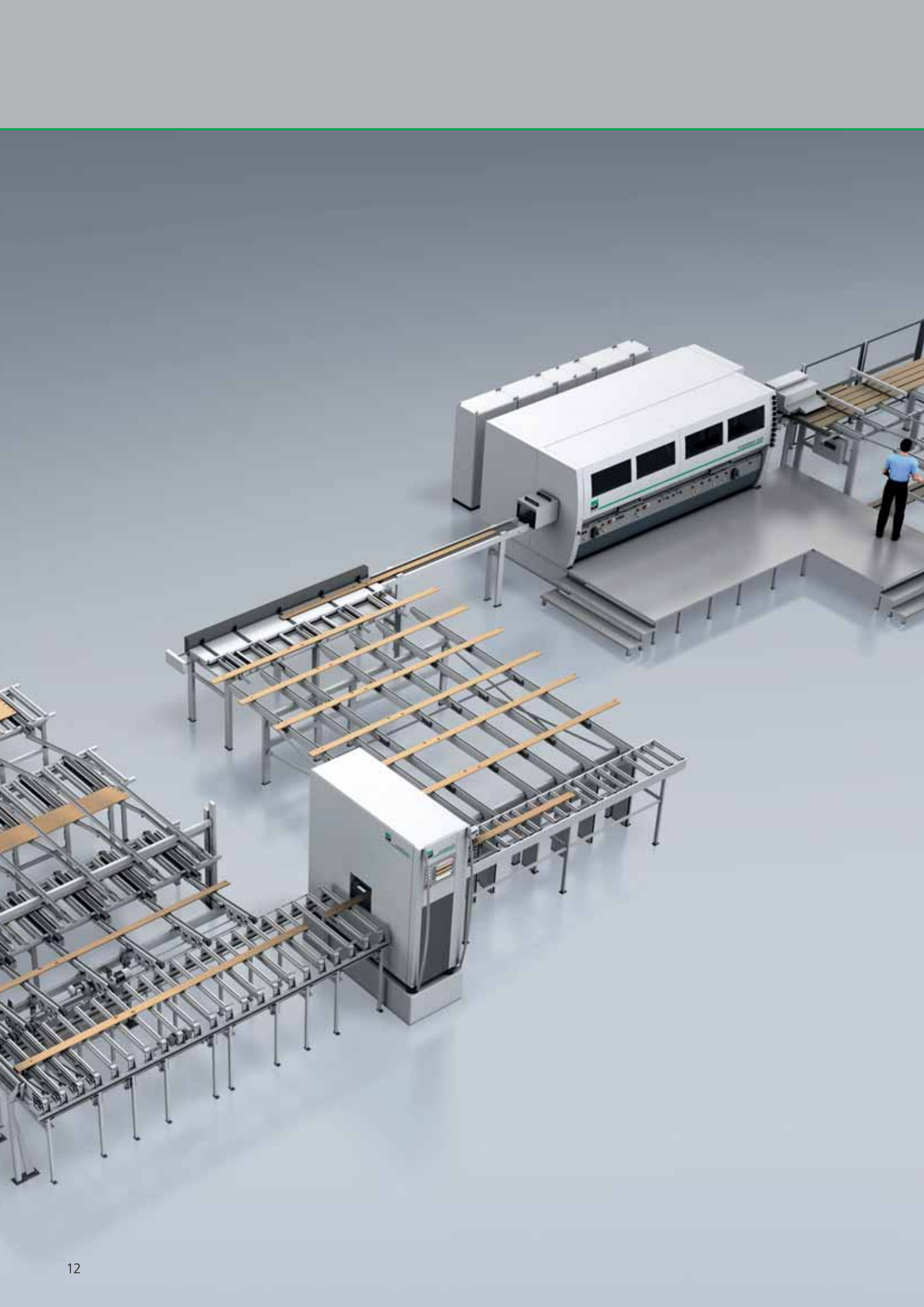

# The modular WEINIG system

The Powermat 2400 already fulfills high demands as a stand-alone machine. However, the full potential could be far greater. By integrating it into an individual WEINIG production system the performance can be increased significantly.

A central starting point is the automation of the machine. Particularly in steady production at high feed speeds or when feeding short workpieces the operator can soon become overloaded. WEINIG has everything needed to make your production more cost-effective, from the infeed system to the packaged end product. Naturally, these systems are always precisely customized to meet your production requirements. You can select from modules of different performance classes, dimensions and equipment. This modular system also allows you to adapt your production to changing market situations or new internal working conditions at any time. For example, a WEINIG scanner allows you to optimize your cutting processes reliably. This is best done with a WEINIG OptiCut crosscut saw or an intelligent WEINIG ripping solution. With WEINIG, the experienced full service provider, you can be sure of one thing: All components of the system are perfectly harmonized to provide optimal results.



# WEINIG Powermat 2400: The application professional



WEINIG offers an exceptional machine as a standard model. The Powermat 2400. From high quality cast iron frame to intuitive and safe operation. The latest technology and a wide range of capabilities make the Powermat 2400 a machine that suits nearly every modern production facility.





### **Spindles**

Product development and manufacturing have a long tradition in our company. You can benefit from our experience of producing 35,000 spindles every year.

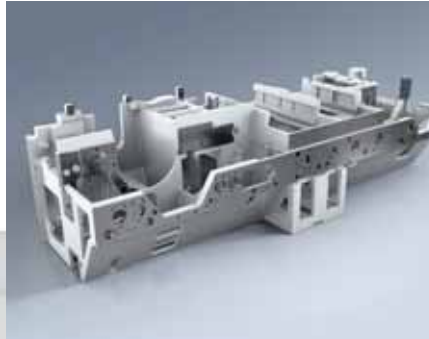

### **Cast iron frame**

We use heavy, vibration absorbing, cast iron for the base of the Powermat 2400.



### **Energy management**

Top performance does not exclude economy of operation. The motors of the Powermat 2400 are designed for cost efficient operation.

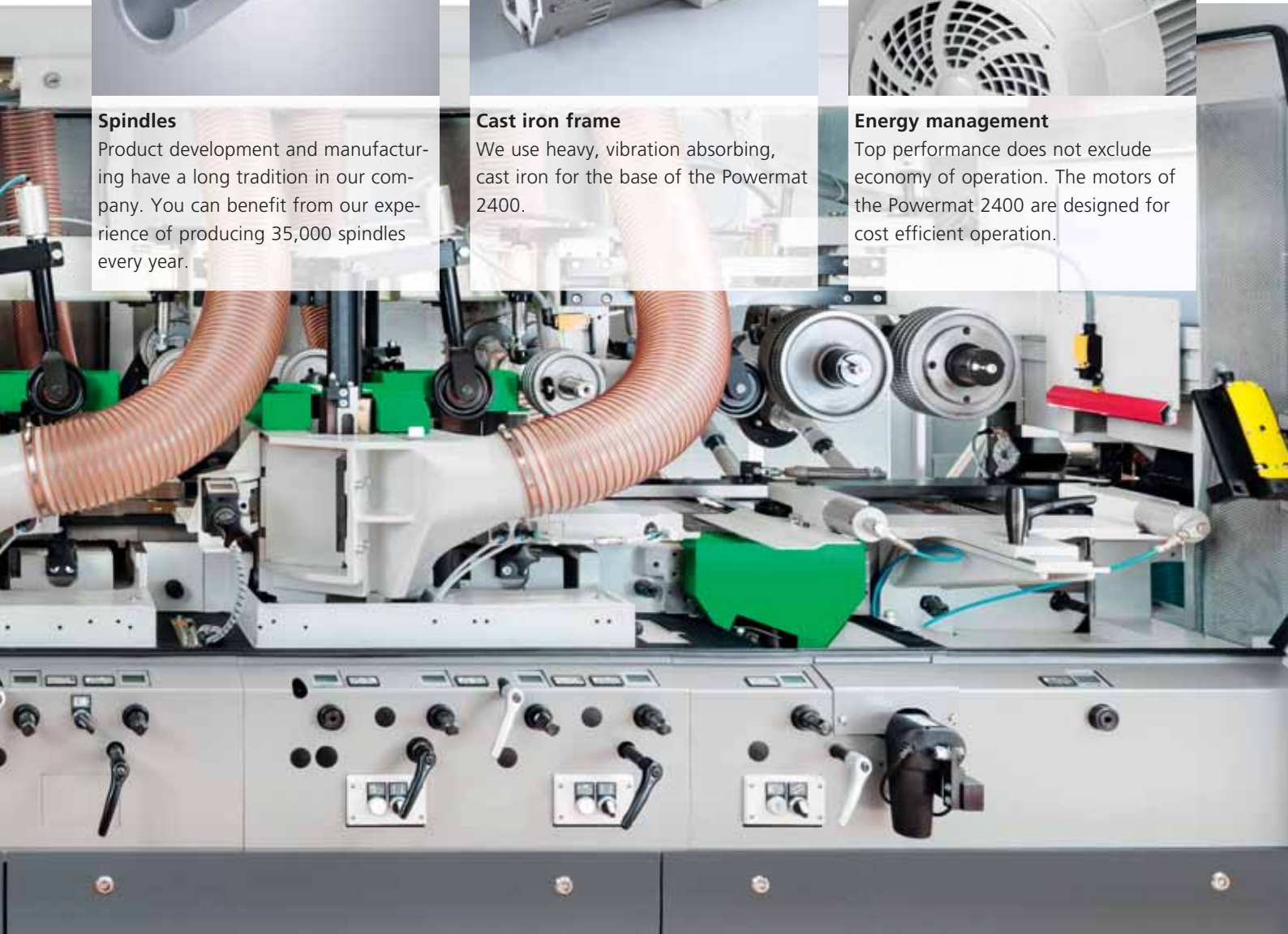

With tool speeds of up to 12,000 rpm, jointing technology and strong feed systems, it provides optimal conditions for series production in the legendary WEINIG surface quality. The modular design and large number of options enables the most diverse applications. Not to mention excellent cost efficiency and resale value.

# The heart of the Powermat: It's the difference that counts



- Tool holder with PowerLock tool
- Conventional tool with bore
- Hydro tool mounted on spindle with outboard bearing



Know how, diligence and quality components. Only when everything is working in perfect harmony do you get a perfect result. That is why the drive system of your WEINIG moulder is made of top quality components. And that is why only highly skilled tradesmen work in our production. From the belt tracking to the bearings to the motor flange: everything has been thought through down to the very last detail. It is the sum total of all these factors that creates the quality you need to be successful in the market – WEINIG quality.

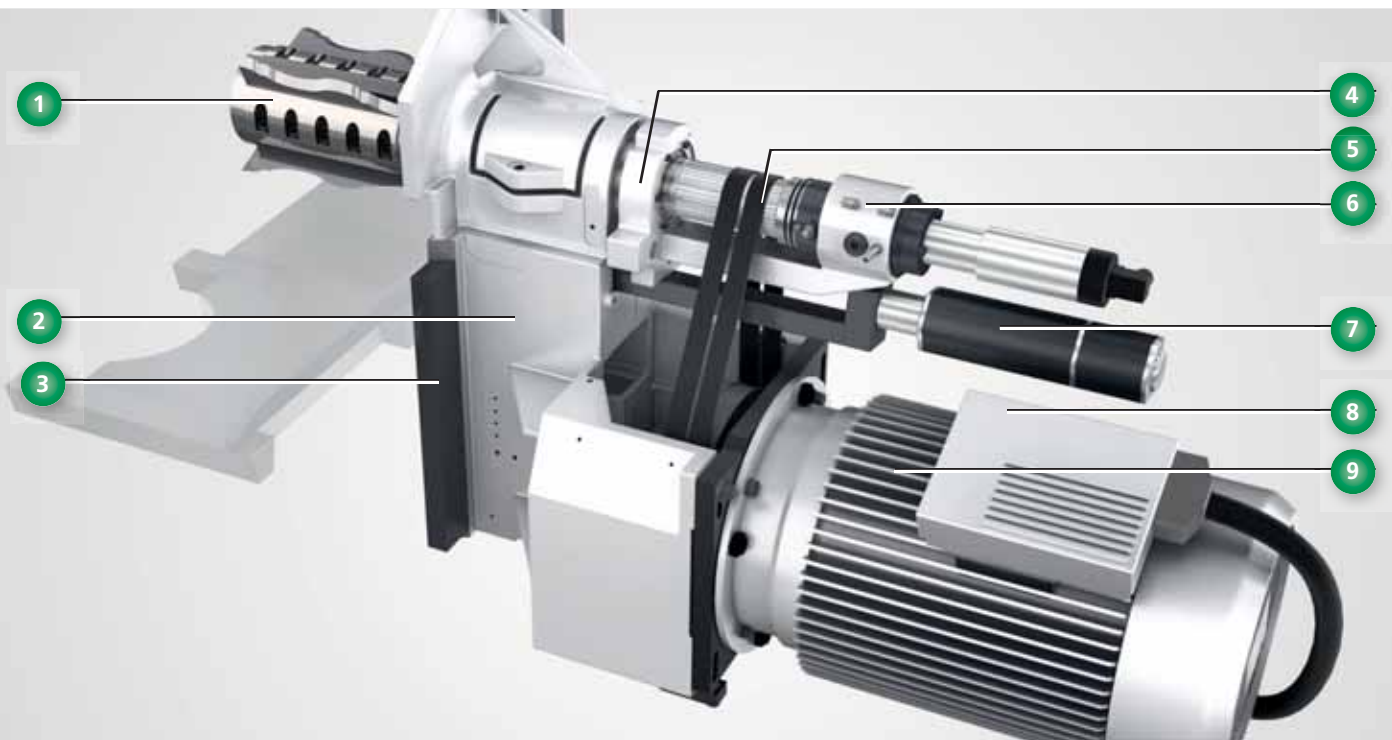

The drive unit of the Powermat 2400:

1. PowerLock tool system: Speed regulation from 4,000-12,000 rpm using a frequency inverter
2. Spindle slide: the cast iron mono block absorbs processing-related vibrations and ensures smooth running
3. Spindle slide with dove tail guide: adjustable
4. Spindle: High tech component with reliable, sophisticated technology
5. Toothed belt drive: improved power transmission and smooth running
6. Central lubrication: easy maintenance
7. CNC axis: exact positioning of spindles
8. EMG-S: electronic motor braking unit with soft start-up: optimizes start-up and braking time, automatic adjustment following tool change
9. IE-2 motor: high energy efficiency in conformance with applicable European standard

- Excellent true running accuracy of spindles
- Long service life for individual components
- Strict quality control
- Over 700,000 WEINIG spindles in use worldwide



# The original PowerLock system: Rapid tool change

When it was first introduced on the market it was a sensation; today it can be found everywhere quality is foremost. The original WEINIG PowerLock tool system. The HSK interface impresses with its rigidity and optimal true running accuracy – combined with “push button” tool changes. Three tons of clamping force combines the two components into a single perfect unit with zero tol-



PowerLock made easy:

Press a button to release the cutterhead, remove it. Insert a new tool and press the button to clamp it. That's all. You have never seen a moulder that you can retool quicker or easier than with WEINIG's PowerLock system.



erance. Irrespective of your production capacity or application – with PowerLock you can achieve outstanding surface quality at speeds of up to 12,000 rpm. With PowerLock you can produce up to double your linear production per day, slash unit costs and shorten delivery times. Simply at the press of a button!



Versatile PowerLock system: Also allows the use of all types of solid body tools. The tool is mounted on a WEINIG adapter or that of a WEINIG partner in the same manner that it would be mounted on a spindle.

# WEINIG jointing system: High-tech requires experience

Jointing technology and hydro tools produce excellent surface quality. Together with the WEINIG PowerLock system, they are unbeatable. In the Powermat 2400, you can choose this combination and profit from it many times over: Jointed tools developed by WEINIG ensure that all knives in the cutterhead have an absolutely identi-



## **Straight jointer for smooth planing**

Automatic and manual jointers with automatic jointing stone advancement for PowerLock tools.



## **Fully automatic profile jointer**

Jointing process performed at the push of a button. When using the profile jointer, the straight jointer can remain in position.





cal cutting circle. This means PowerLock produces excellent surface quality at up to 10,000 rpm and maximum feed speeds! WEINIG know-how and experience guarantee complete process reliability of our leading edge technology.

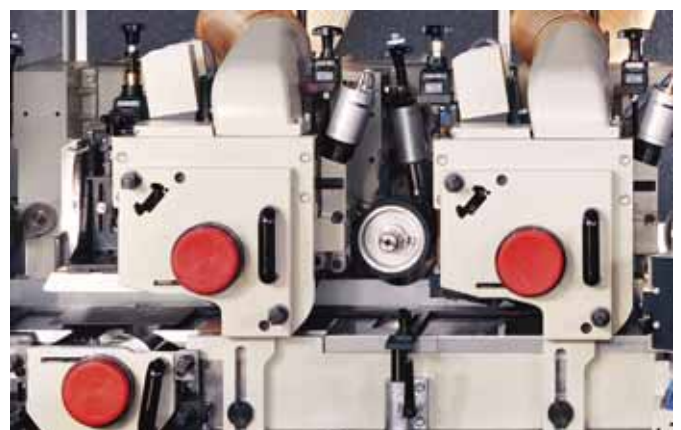

**Outboard bearing with axial adjustment sleeve**

The full range of axial adjustment can be made while the outboard bearing remains clamped.



**Robust cardan drive shafts**

Reliable drive even under continuous hard working conditions. Minimal tolerances and maintenance-free.

# Cast iron frame and WEINIG table plates: The basis for excellent surface quality

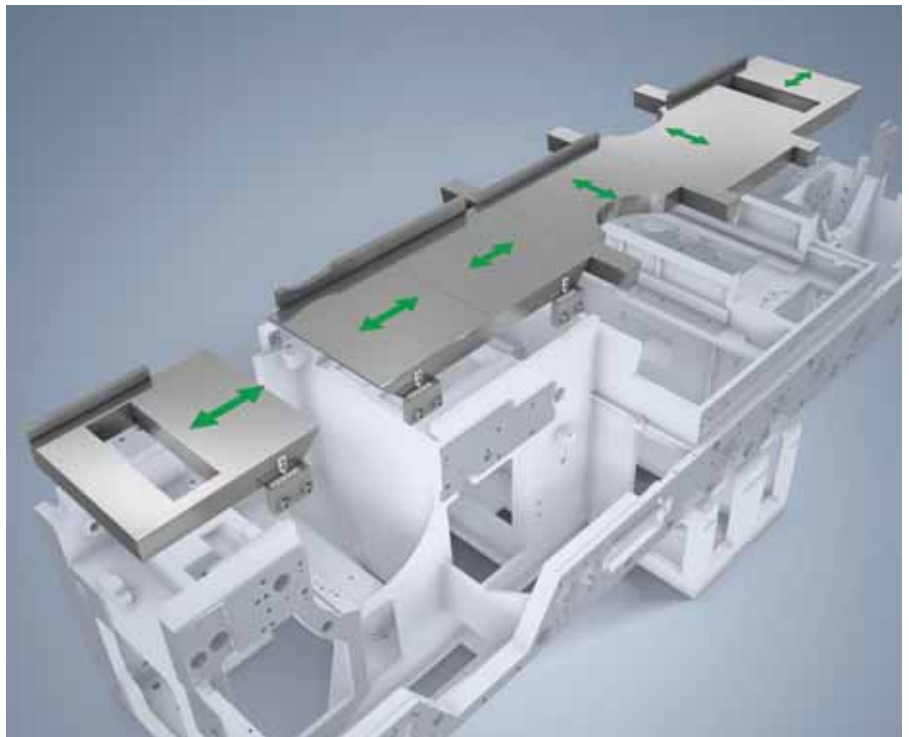
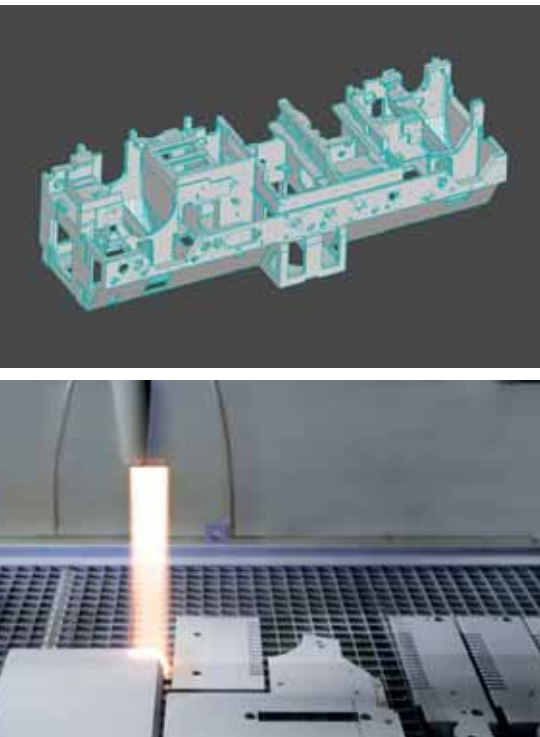

The very latest software programs are used in product development (FEM/ CAD-3D). The production process is monitored using latest technology measuring instruments. CNC machining in a single clamping operation ensures ultimate precision.

- Heavy construction
- Minimum vibrations
- Extremely smooth running
- Perfect surface quality
- Uniform cutter marks

## **MarathonCoating**

- Long service life for the table plates
- Reduced friction
- Superior bonding (no flaking off)
- Very good corrosion resistance
- Ecologically responsible production process

In order to be able to produce quality, smooth running is paramount. This is why the Powermat 2400 has a heavy, vibration absorbing cast iron base. This solid base allows the high quality components from WEINIG to demonstrate their superiority. The result is workpieces that meet the highest demands in precision and surface quality.

The table plates make a sizable contribution to a perfect finish. The long-life MarathonCoating guarantees lastingly good workpiece transport with low friction. With WEINIG's table plate system the table plate can be set to the tool radius quickly and easily. The segmental design of the WEINIG table plate system means that individual elements can be replaced easily. Each table plate dimension is fully documented, allowing a replacement delivery even years later.

# Guiding and controlling of workpieces: Our core skill



Special attention is placed in those areas where the workpieces are being guided and transported. The newly developed and improved pointed tooth rollers 2.0 of the WEINIG feed system reduce tooth penetration into the wood to a minimum and are self-cleaning. Our pneumatic pressure elements ensure highly accurate control of the workpiece. The table plates are coated with MarathonCoating so the workpiece slides over the table without being damaged. WEINIG's expertise can be seen and felt on the workpiece. You will be delighted with the surface quality as well as the repeatable dimensional accuracy of the Powermat 2400.

1. 3-roller infeed with driven table roller
2. Driven table roller, height adjustable
3. Opposing outfeed rollers
4. Pressure elements with pneumatic control
5. Pressure shoe with cassette system
6. Precision dowel guide



# The electrical system: Power from the cabinet

With the growing complexity of machines the requirements of the electrical system have soared. The switch cabinet has our full attention. For the sake of our customers, because we know: the better organized things are behind the doors, the more trouble-free the machine will run. Only specially qualified personnel are employed in WEINIG's electrical assembly department. They ensure that the power is sent to the right receiver.



The designation of equipment is structured logically and arranged according to function. Each component in a WEINIG switch cabinet is designated with a specific number. If a fault occurs, the WEINIG service team only needs this number from the customer. An invaluable advantage which ensures that your machine will be quickly back in production.



Different countries have different standards and regulations. At WEINIG, every machine we make conforms specifically to the regulations of the country it is being sent to.





The high tech electrics in our moulders are developed in close cooperation with international companies such as Siemens. For example, the new motor starter design resets its parameters according to the weight of a newly inserted tool and optimizes the load.



A faulty contact in the electrical system can cause the machine to shut down. WEINIG switch cabinets undergo a comprehensive functional test according to a checklist before leaving the assembly area. All working processes of the moulder are simulated.

# Original WEINIG feed rollers: It's the grip that counts

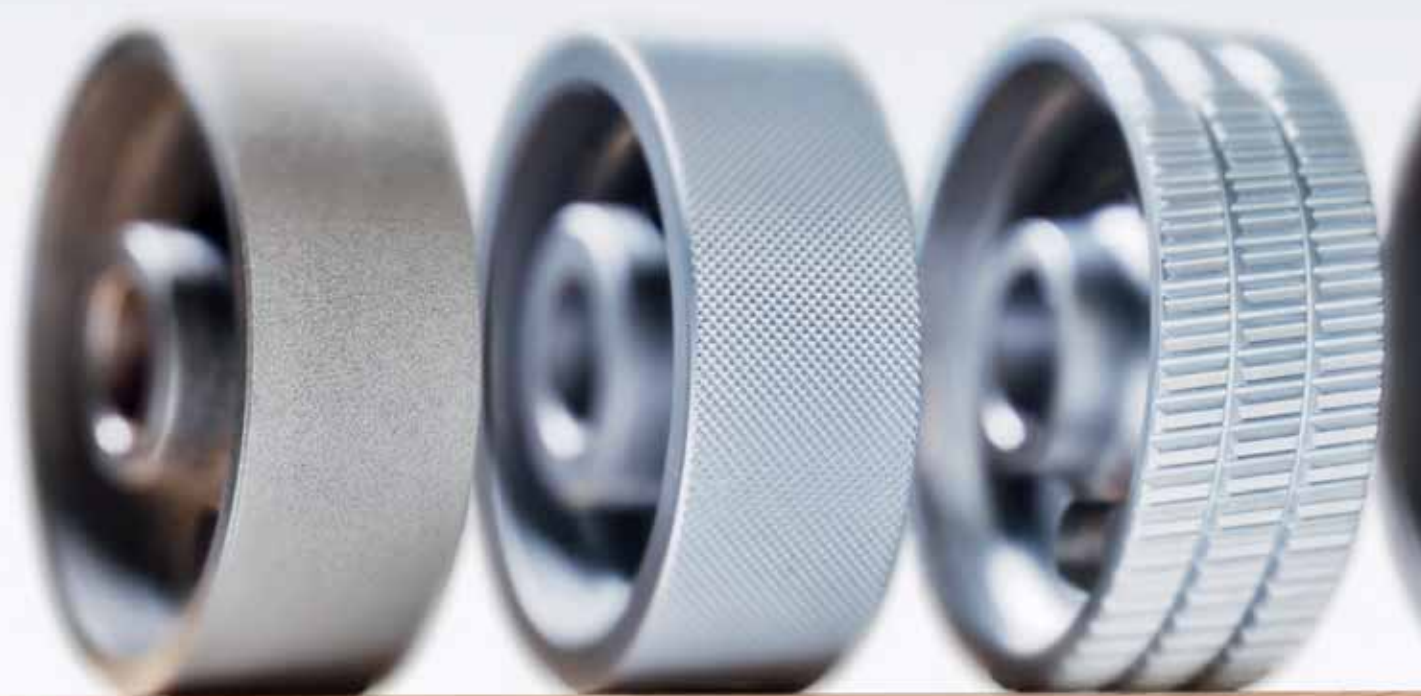

## **WEINIG CeraCoat roller**

A coated roller for highly abrasive materials. Abrasion-proof, long service life, no indentations.

## **WEINIG Durofer steel roller, knurled**

The ideal roller for hardwood and panel production. Maximum grip but without surface marking, even under high pressure.

## **NEW: WEINIG pointed tooth roller 2.0**

Universal roller with maximum grip, more feeding power and longer service life with less debris build up.



Geometric alignment of teeth, contact surface, material properties – feed rollers are a science all on their own. With original WEINIG feed rollers you can be sure that your workpieces are transported optimally through the machine in every application.

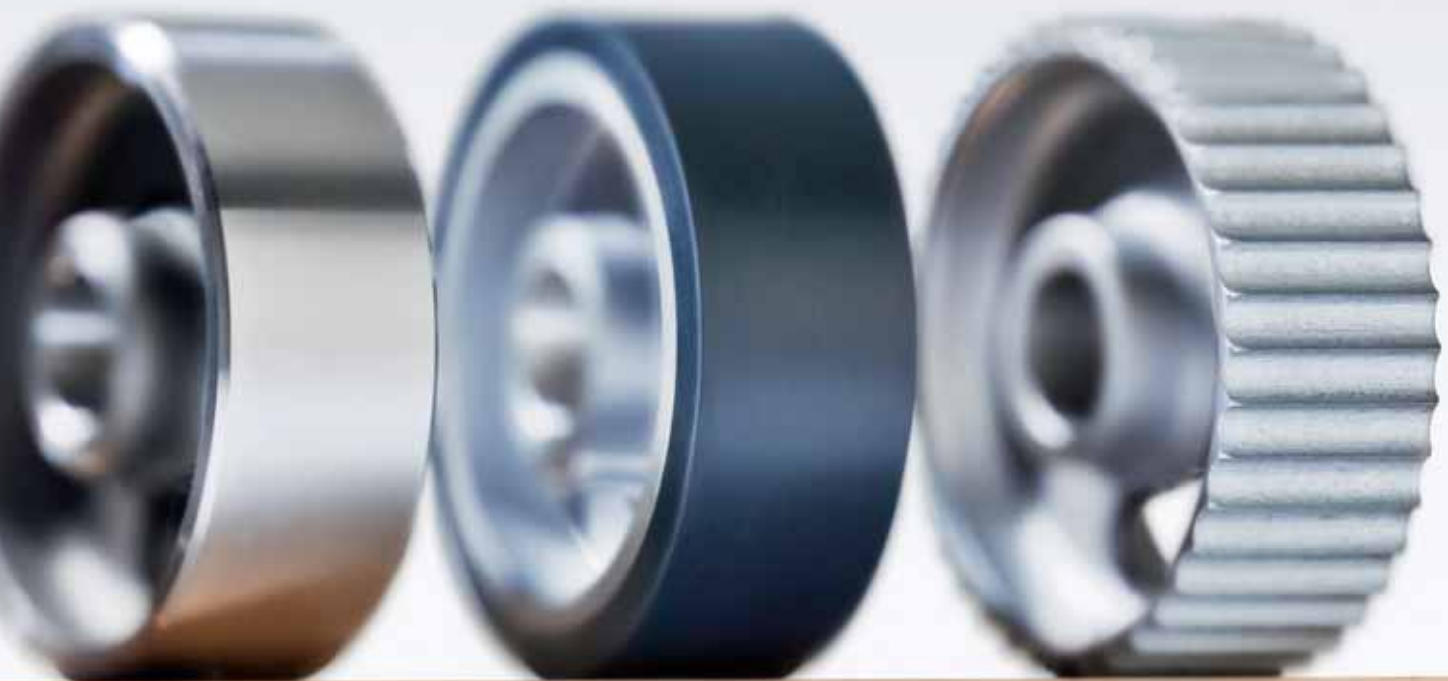

**WEINIG Durofer steel roller, smooth**

The ideal roller for transporting workpieces with a finished surface. No indentations.

**WEINIG roller, vulcanized rubber**

The ideal roller for profiled surfaces. Different vulcanized rubber mixtures with high wear resistance and high traction are available.

**WEINIG Durofer fluted roller**

The ideal roller for wet or exotic woods. High power transmission, long service life, self-cleaning.

# Added value: All-round machining and ripping in a single

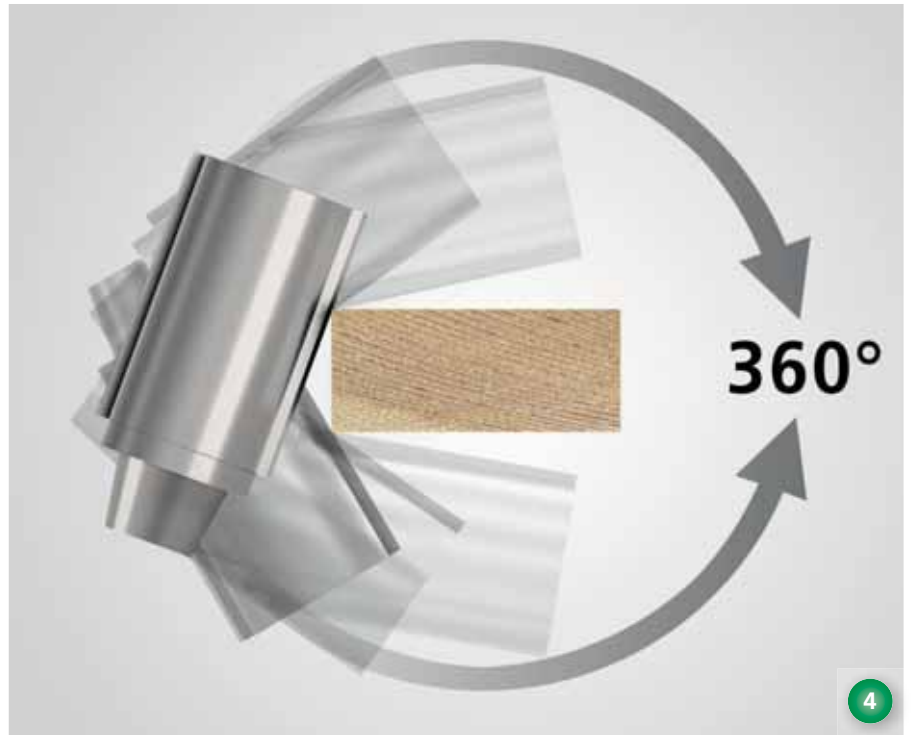

1. Planing and ripping in a single pass
2. Angled ripping
3. T-groove milling – with plastic too
4. Universal spindle

**Planing, profiling and ripping** in a single pass? Not a problem for the Powermat 2400. The bottom spindle turns your machine into a multi-blade rip saw. The first bottom spindle creates a flat reference surface. The workpiece is moved smoothly and accurately during ripping. This increases the service life of the saw blades.

**Angled ripping** is an interesting option for working more efficiently. This will allow you to achieve higher wood recovery during subsequent profiling. **T-grooves** and other high-precision grooves can also be profiled on the Powermat 2400 in a single pass. A universal spindle is used for this as a router with PowerLock interface. Such a **universal spindle** is sensible as an additional spindle element if you often have extraordinary tasks to handle. The universal spindle can be positioned over a full range and can be used as an additional spindle on each side. Ideal.

pass



1. PowerLock adapter with drive slots
2. Splitting wedge cassette

Profitable production of lamellas requires process reliability, short setup times and maximum wood yield. With the flexible PowerLock tool system, the Powermat 2400 offers optimal conditions to achieve these goals and sets new standards with thin kerf technology. For ripping, the sawing sleeve is mounted directly on the PowerLock adapter. The rigid HSK interface ensures optimal axial alignment and true running of the sawblades. Thanks to these benefits, kerf dimensions as low as 1.2 mm can be achieved.

In addition, the design of the PowerLock system ensures excellent machining quality. Changing the adapter mounted sawblades is easy to perform as is the splitting wedge cassette system. The integrated spray unit improves sawing efficiency. This also allows the use of significantly thinner kerf sawblades to increase the material yield. The splitting unit is also available as a free standing unit.



For more information,  
go to [film7.weinig.com](http://film7.weinig.com)



# Added value: Cost-effective processing technologies



**1. The challenge of resource management** – Cross laminated timber (CLT) as well as face laminated timber must be pre-planed prior to scanning. This offers high potential for wood savings. Intelligent WEINIG technologies make processing more profitable.

**2. Angled spindle** – horizontal spindle mounted at a 30° angle to the machine fence. The tool cuts into the wood with a sheering action. This means the wood can be processed with significantly reduced chip removal and with greatly reduced "snipes" or "dips".

**3. Floating spindles** – opposing vertical spindles that follow the bow of the wood. The glulam lamellas are planed parallel to a consistent width with minimum stock removal. Floating spindles – fixed and opposing – can also be used as normal profile spindles.



For more information,  
go to [film9.weinig.com](http://film9.weinig.com)

## Added value: Opposing spindles

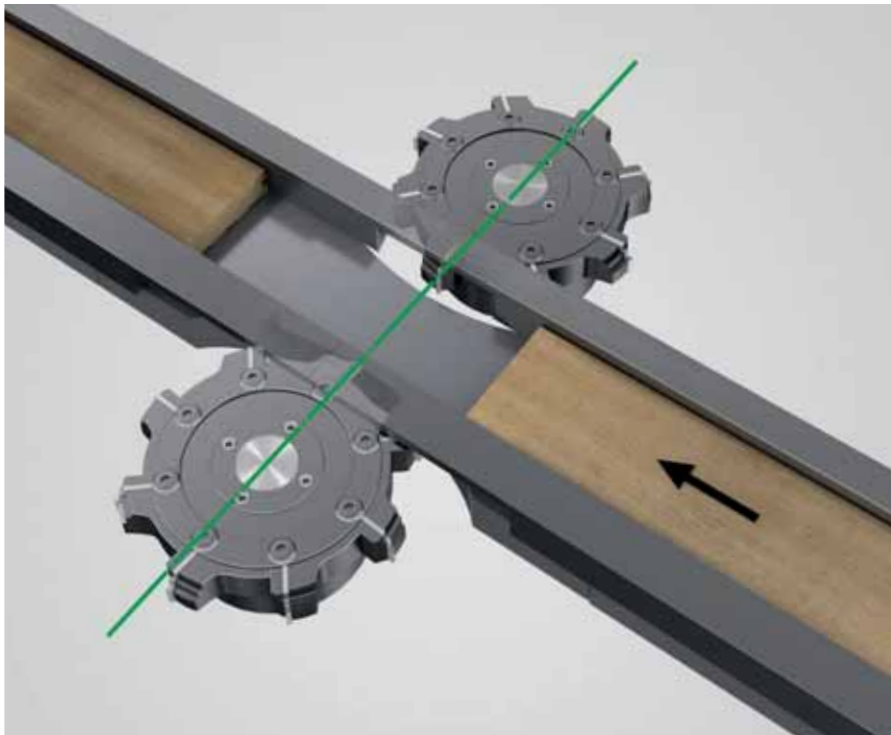

When it comes to producing quality T&G flooring, the precision must be in the range of hundredths of a millimeter. WEINIG offers you an intelligent solution for this. Whether you are producing solid wood T&G flooring or engineered flooring with click profile; with micro bevel or straight edges.

The heart of the technology is the opposing vertical spindles. This allows the tongue and groove side of the workpiece to be processed simultaneously. The profile splitting process allows short workpieces to be produced with little or no "snipes" and "dips". This uses two pairs of vertical spindles one after the other. The WEINIG Powermat 2400 allows you to achieve the high feed speeds required for large production runs. And the quality of the parquet is bound to impress you: Straightness, parallelity and shoulder accuracy are of the highest possible standard – as you would expect from WEINIG.

## Greater utility: Texturing and carving

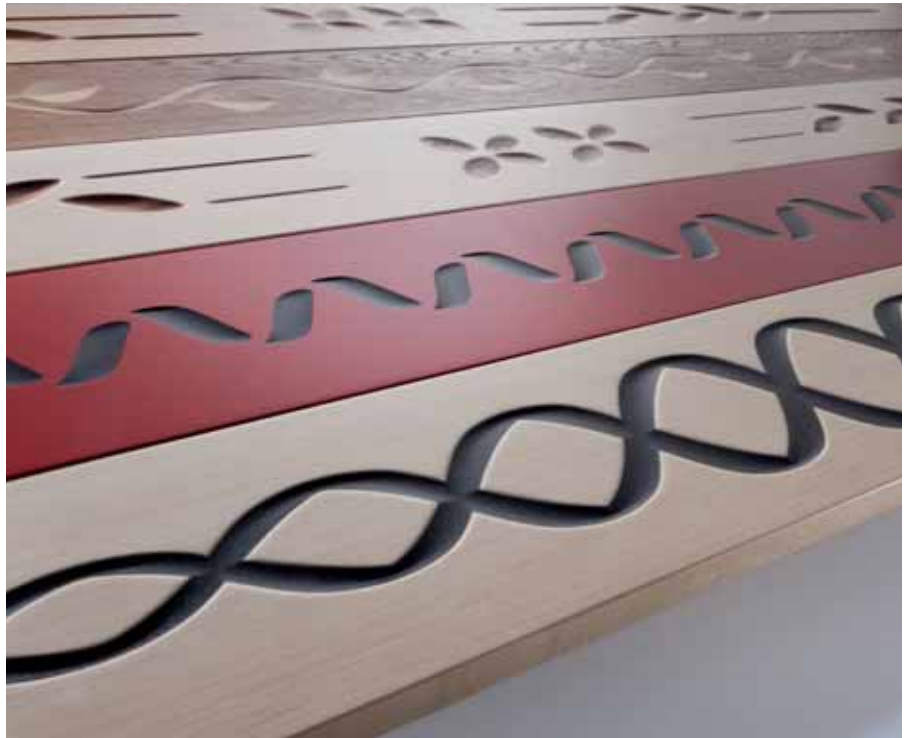

Creative surfaces are in fashion. With the Powermat 2400, you can create complex surface textures in a single pass at feed speeds of up to 60 m/min. Two processes are available to you: Textured surfaces with a rustic look are produced with a random generated spindle movement and 3D carved designs are produced with programmable CAD/CAM software controlling spindles or aggregates.

The WEINIG texturing and 3D technology open up a wide application spectrum – from furniture elements to flooring as well as outdoor wood products. What this means for you is differentiation from the competition, greater flexibility and higher machine utilization. And there is no need to worry about cost-effectiveness: The Powermat 2400 retains its qualities as a universal moulder for planing or profiling any conventional products.



## Greater utility: Jumping spindle

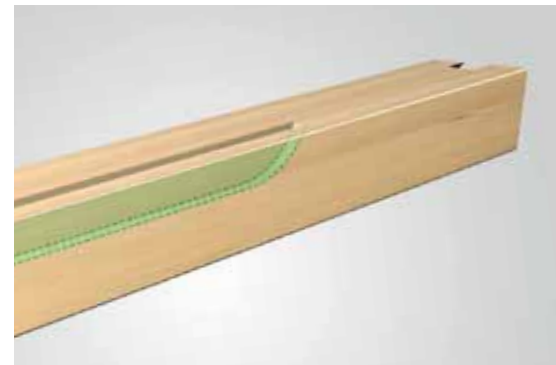
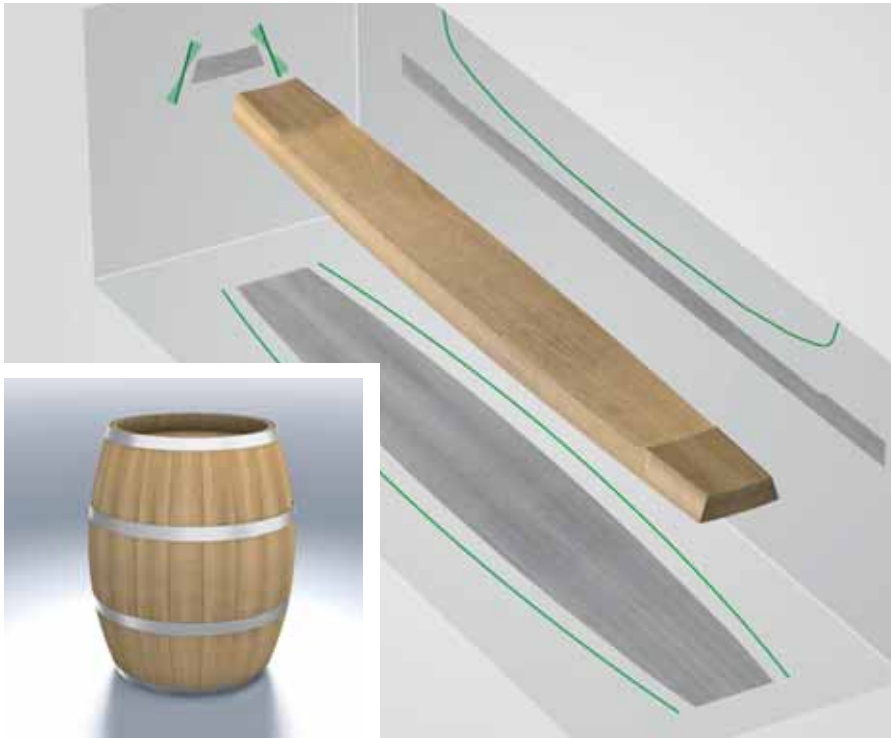

Intermittent bevels on pallets for pallet truck forks, intermittent grooves for furniture components or the varying angles and width for barrel staves present a challenge in production. The WEINIG CNC-controlled jumping spindle makes it possible to integrate high tech processes such as these into your production at high production cycles and with reliability. Individual part production guarantees optimal quality.

When it comes to producing barrel staves, WEINIG shows what they are really capable of: At the same time as the stave bevels are being shaped by the vertical spindles a relief with a defined position from end to end is being produced from the top spindle. Indispensable to create the bilged shape of the barrel!

The pallet industry is the most common application of the jumping spindle. The technology is essential for creating the beveled edge between the pallet spacer blocks. The values for the jump-in and jump-out positions are simply entered into the PowerCom computer.

## Added value: Other materials

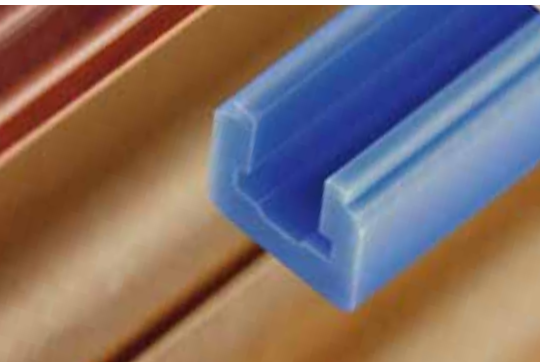

WEINIG is committed to solid wood. This statement is correct but that is not all! Other materials can also be processed on our moulders with the same high quality. In addition to all types of plastic materials there is the popular range of WPC (wood plastic composite) products. However, even challenging products such as insulation strips for transformers or cement fiberboard are no problem for the Powermat 2400. No matter what material is to be profiled, planed or even wire brushed – the high performance, surface quality, repeatable accuracy and production flexibility are without limits.

## Added value: Pencils and dowels



Features such as; PowerLock tools, PowerCom with CNC, a feed system specially tailored to the production task and an integrated feeding magazine make the Powermat 2400 the most high-performance pencil machine in the world. When it comes to producing dowels, this moulder impresses with outstanding repeatable accuracy, feed speeds of up to 25 m/min and high surface quality.

In addition to the pencil profiling moulder WEINIG offers a splitting unit to split the slats and grooving moulder for the graphite rods. All specially equipped with the accessories needed to produce perfect pencils. Dowels, curtain rods and broom handles are further areas of application for the WEINIG technology.



# Options: A clever decision



The Powermat 2400 is specially designed for high flexibility and can be equipped with many options. Your WEINIG expert will be pleased to help you decide to what degree a particular option makes sense or how other components can work together to make the machine even more efficient for your production needs.



### 1. Groove guide

The WEINIG groove guide is an ideal option for controlled processing of short and difficult to guide workpieces. The result is straight and accurate workpieces. Crooked or distorted workpieces are straightened on the face and edge. Tapered or curved workpieces can be planed to an exact thickness.

### 2. Mobile spindle

When processing random width material for laminated wood panels, stair treads or cabinet doors, for example, the mobile spindle from WEINIG is an excellent choice. This multi-tasking unit automatically measures the di-

mensions, adjusts itself to the relevant width and processes the workpiece with optimal wood yield. All in one cycle. It is operated via the control system of your Powermat 2400.

### 3. Reduced feed roller spacing

This option guarantees continuous transport of short pieces through the machine while preventing snipes and improving straightness.

### 4. Expertise in large and small

WEINIG has know-how for all applications. We have the right solution for moulding manufacturers, but also for producers of construction timber with cross sections up to 310 x 200 mm.



For more information,  
go to [film4.weinig.com](http://film4.weinig.com)

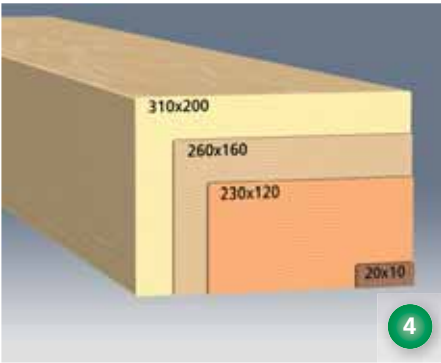

### 5. 2nd tilting spindle

With this spindle it is possible to tilt up to 45° to produce a bevel with a planing cutterhead. It is just as easy to produce an undercut or an angled groove with this spindle.

when the material dimension is changed. A change in size does not require a change of tools and hence no change-over time.

### 6. Reinforced feed roller shaft

In conjunction with large working dimensions it may be recommended to equip the machine with reinforced feed roller shafts. This guarantees optimal process reliability when it comes to transporting heavy workpieces.

### 7. Chamfering unit

WEING processing technology means that the chamfering aggregate moves automatically to the correct position

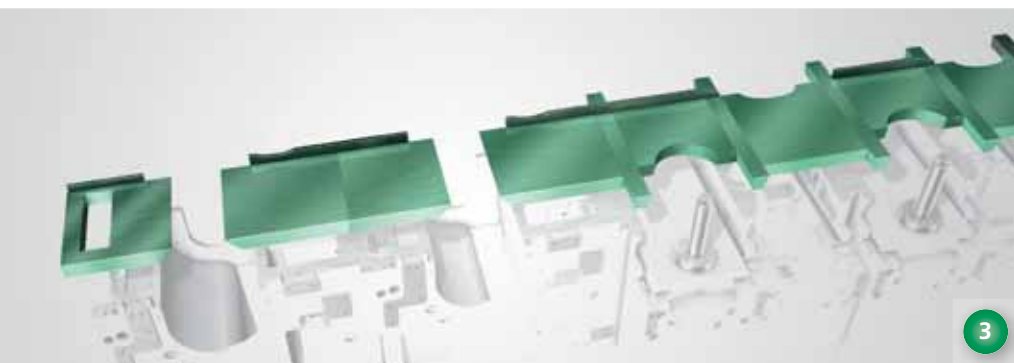
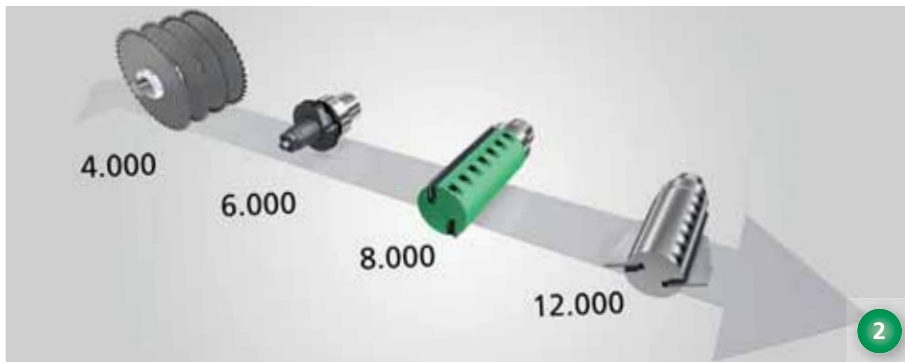

### 1. Anti kick-back device

A curtain of steel lamellas is located in front of the first infeed roller, preventing a kick-back of split workpieces. This reliably prevents injuries to the operator.

### 2. Frequency inverter

This practical option enables the spindle speed to be regulated to a different rpm to suit a new application or type of tool.

### 3. MarathonCoating

This special coating protects the machine table, fences and pressure elements from excess wear. This option is to be recommended especially when processing abrasive materials

such as tropical woods or MDF. There are three types of coatings available: MarathonCoating, MarathonPowerCoating and MarathonPowerCoating PLUS. The production process uses an environmentally friendly technology which does not generate any waste material.

### 4. Automatic Waxilit pump

This option allows you to optimize the amount of lubricant required to prevent resin build-up and support continuous transport of workpieces. The volume of lubricant and the intervals of application can be controlled by PowerCom according to the particular requirements.





5



6



7



8



9

### 5. Cassette system

The cassette system for counter profile shoes and special guides provides equal pressure at multiple points over the profile contour. This offers the advantages of improved surface quality and an enormous saving in setup times because the cassette is quick and simple to insert and clamp. A stop screw ensures that once the counter profile shoe has been set it will always reset to the same position.

### 6. Adjustable pressure bars

Various sizes available for different profile depths.

### 7. Setting stand for cassettes

This option allows you to quickly and easily pre-set counter profile cassette shoes to match the profile in the moulder without any additional adjustments.

### 8. Assembly stand for PowerLock tools

Installed in the grinding room, this device is used to ensure safe installation and changing of the knives and contributes to tool precision.

### 9. Counter profile shoe

A steel base plate with hole locations for screws to secure a counter profile shoe made of plastic or wood to it.



**1. Universal spindle**

The universal spindle increases your flexibility enormously because it can be used in 360 degree operation. Complex profiles and undercuts can be performed easily in one operation.

**2. Router application**

T-slots and other precision grooves can be profiled in one operation. A universal spindle with PowerLock cutterhead, which can be positioned over a range of 360°, is used for this.

**3. Improved sound insulation**

The machine enclosure is reinforced with a multi-layer construction having

a thickness of around 85 mm. This means a noise reduction of ca. 15 dB can be achieved.

**4. Motorized adjustment and positioning of jointing fences and straightening table**

Adjustment and positioning at the push of a button.

**5. Climate control unit for switch cabinet**

This option protects your valuable machine from overheating and extreme cold. It serves as a cooler unit for ambient temperatures above 40° C. Or as a heater to prevent



failure of electronic components at temperatures of 5° C and below. Climate control is also available for the separate operating panel with touchscreen.

Required for machines with 8 spindles or more! Cable length of switch cabinet to machine is 2.5 m.

**6. Operating panel separate from switch cabinet**

A stand-alone operating panel makes sense if space allows. This gives the operator greater comfort and flexibility.

**7. Switch cabinet and operating panel separate from the machine**

A particularly convenient solution that allows scope for individual organization throughout the work area.





1



2



3



4



5

**1. 3-roller infeed**

Ensures optimal feeding force for profiles and boards. Optimal results when combined with a mechanized infeed

**2. 4-roller infeed**

Heavy design with two feed rollers and two opposing table rollers. Optional with 220 mm feed roller diameter. Particularly suited for large cross sections with long lengths as well as bent and twisted material.

**3. Powerset**

Manual or motorized setting of the pressure elements before and after the left vertical and top tool holders. Side pressure rollers are arranged to protect against mechanical conflicts.

**4. Pressure elements with digital displays**

A control system supplies actual/target value information, is quick setting and guaranteed in the right position.

**5. Rotaplan pressure shoe**

Individually spring-loaded lamellas located above the bottom spindle guarantee an excellent surface finish even on scant material.

**6. Package Light Plus**

High performance LEDs provide bright lighting inside the Powermat. The homogeneous full illumination mimics natural daylight to create excellent conditions for precise work and optimum results.

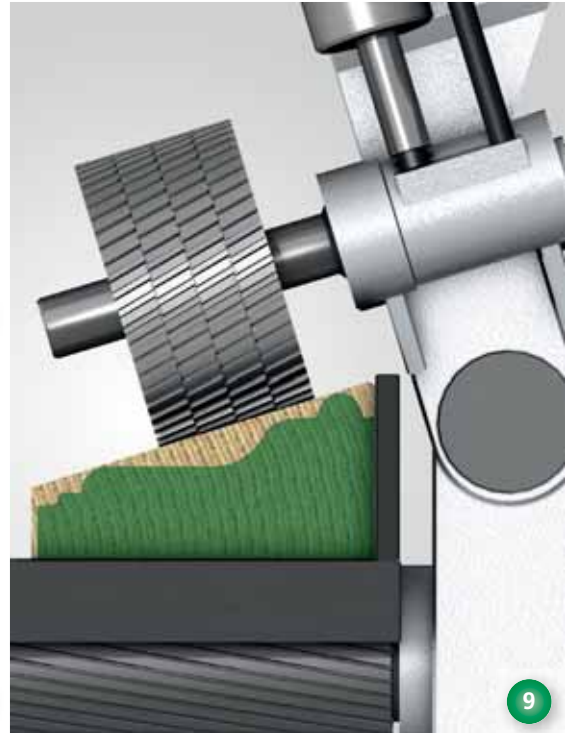
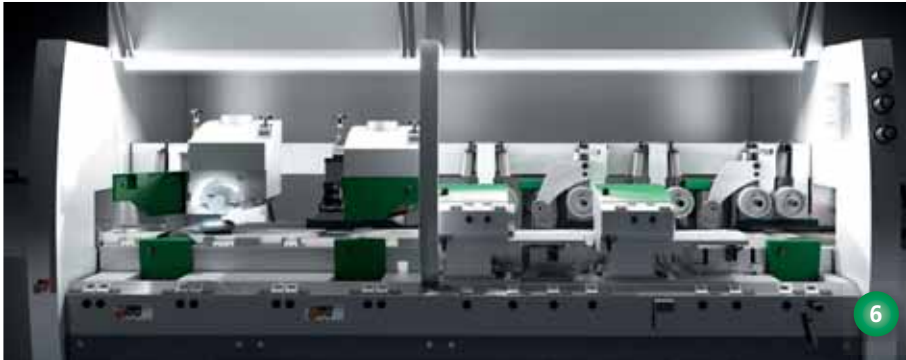

### 7. Jointing stones

The selection of the correct jointing stone is dependent upon the quality and hardness of the knife material being used. Jointing stones made of ceramic bonded mineral powders are used for HSS and Stellite knives. Special WEINIG jointing stones of greater hardness or with diamond inserts, are used for carbide knives.

### 8. Jointer presetting stand

Ideal for work preparation that saves on set-up time: The profiled jointing stone is mounted in the setting stand along with the profile cutterhead and pre-set to match the position in the moulder. This greatly reduces the set-up time required from one jointed profile to another.

### 9. Tilting feed beam

This enables optimal conditions to enable feeding and guiding of bevel re-sawn material. A tremendous increase in material yield can be achieved. The WEINIG tilting feed can be pivoted to suit any bevel from 0 to 15°.

# WEINIG's safety package: Much more than CE

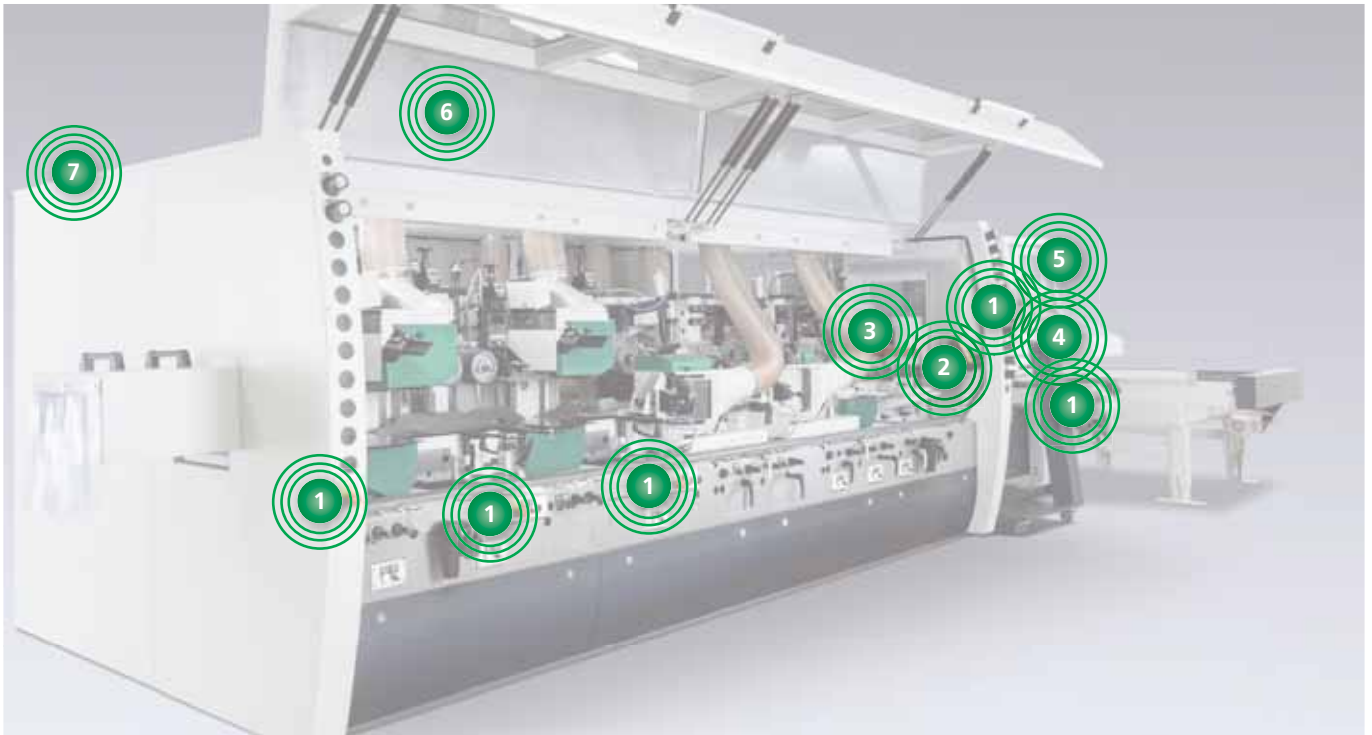

When it's a question of the safety of your machine and your employees, it is not enough to have a simple CE label stuck onto your machine. CE is good, but we are better. WEINIG supplies the Powermat 2400 in standard with a voluntary comprehensive package for active and passive safety. This includes:

1. Emergency stop buttons
2. Electromagnetic lock for the safety cover
3. Infeed flap switch (for hand protection)
4. Anti kick-back device (optional for splitting)
5. Key switch for mode of operation: automatic, manual or setup
6. Full safety enclosure
7. Electronic spindle brakes



# The control systems: Two for each individual requirement



## PowerCom Plus

- Multiple machine control system
- Machine and production data
- Tool and profile management
- Number of profiles: up to 10,000
- Production and order optimization
- User management
- Grinding room connection



## Memory Plus

- Teach-in oriented
- Standalone machines
- Number of profiles: up to 500
- Simple profile management

# PowerCom Plus and Moulder Master: Networked with your environment



**PowerCom Plus** displays all important system information at a glance. User-friendly touchscreen. The control system gives you access to the data of up to 15 machines. You can position any number of axes automatically at the touch of a button. Documentation of operating and machine data gives you the ability to optimize your production.



Those who are measuring tool dimensions have taken a decisive step toward workpiece precision and reduced setup times. OptiControl allows you to determine tool measurements with ease. Data is sent online to the control system. This makes machine setup child's play.

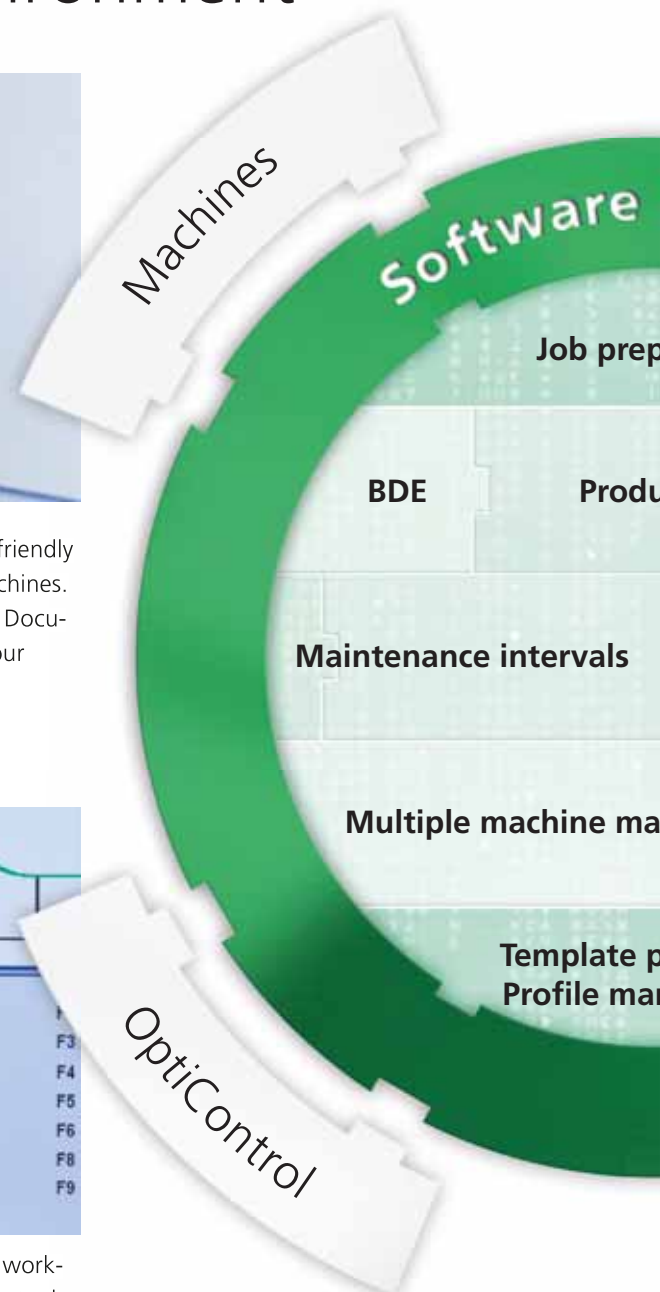

ODC = operating data capture

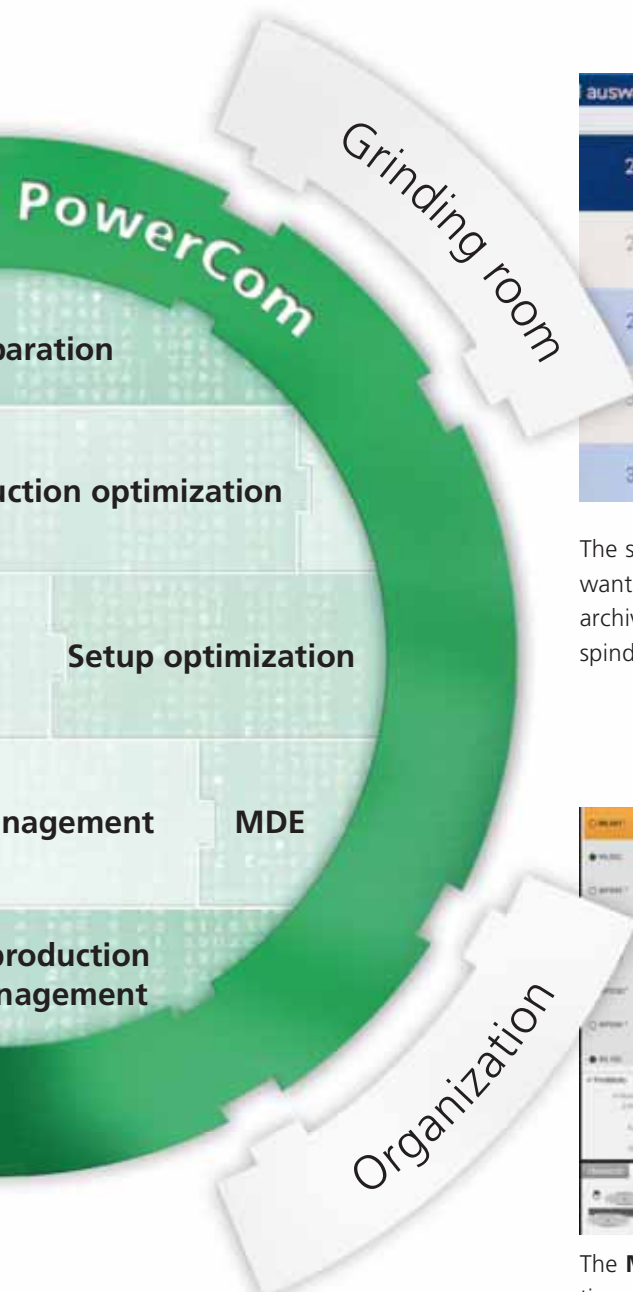

auswählen				
	Symbol	Bezeichnung	Gruppe	Typ:
2090		Riffel fein unten 6771/75 Breite: 150.00 Höhe: 25.00	0	
2130		Parkett (Feder 5 mm) Breite: 70.00 Höhe: 19.00	0	
2462		Handlauf Breite: 50.00 Höhe: 45.71	0	
3014		Verleimprofil (Treppe) Breite: 65.00 Höhe: 42.00	0	
3050		Verleimprofil Breite: 200.00 Höhe: 19.00	0	

The software enables you to manage data for up to 10,000 profiles and tools. If you want to produce a certain profile, the data is at your fingertips for retrieval from the archive. The settings are shown on a digital display on the adjustment axes of the spindles and ensure exact reproducibility of your work piece.

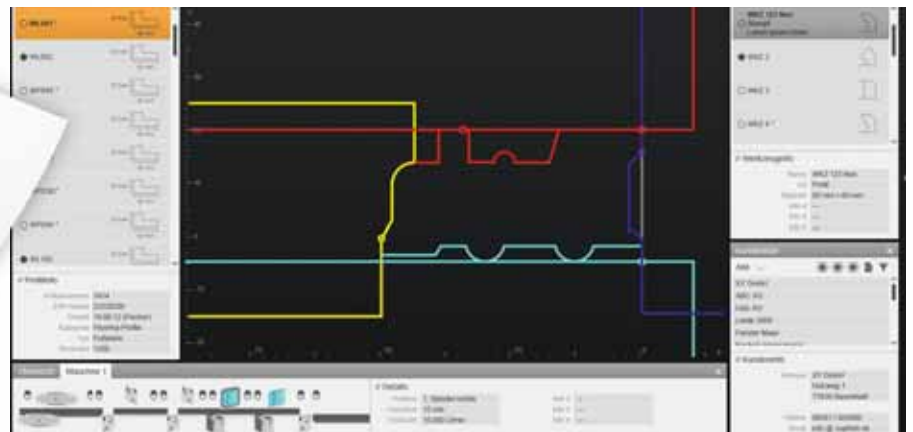

The **Moulder Master** combines all processes upstream of production. In conjunction with PowerCom, the software covers the entire process sequence up to setup of the machine. Profile and tool drawings can be created on a CAD interface. This enables a paperless production run with high process reliability and allows efficient management of data records.

MDC = machine data capture



# Memory Plus: Machine management in a class of its own



- Lightning-fast setting of workpiece dimensions
- Operation via touchscreen
- Clear presentation, tool radii entry via touchscreen
- Required tools displayed for each profile
- Tool data calculated automatically after sharpening
- Correction mode for easy-to-make settings
- Profile list with up to 500 profiles
- Further applications:
  - Mobile spindle
  - Rounding and chamfering
  - Separating glazing
  - Storing profiles after the teach-in process

The software was developed specially for dimensional planing with a constant tool cutting circle. Operating the control is self-explanatory. A touchscreen with clear digital displays and unique symbols offers a high level of convenience. With Memory Plus you can set workpiece dimensions as quick as a flash. Tool radii are entered on the touchscreen. Tool radii are calculated automatically when regrinding. Up to 500 Profiles can be stored in a list. A screen display provides information on the tools required for each profile. The highly flexible Memory Plus allows you to control further applications, such as a mobile spindle and separating a glazing bead.

# The WEINIG system: Integrated organization of the machine infrastructure



The WEINIG System enhances your Powermat 2400 to become a highly efficient machining center that raises productivity. The individual system modules fit together like building blocks to produce the perfect result. From tool preparation to moulder set-up. You can make your own knives and sharpen them with the Rondamat tool grinder. The advantages for you: this makes you independent from tool services and shortens your delivery times. The OptiControl measuring system and PC located in your tool room are used to determine tool measurements and enter profile data. This information is automatically transferred to the machine PC, which saves the values and provides these via the PowerCom controls to the spindles. Then simply press a button to start production of the profile. So simple, fast and repeatable at any time - that is production with the WEINIG system!

# Original WEINIG tools: Quality tested top technology



1



2



3

1. Original WEINIG Hydro-planing head type 502 Rotaplan with thin planer knife
2. Original WEINIG Hydro-profile milling head type 504 with clamping screws
3. Original WEINIG spiral milling head type 542 with turn-around carbide tips

A chain is only as strong as its weakest link. Which is why you should rely on WEINIG for your tooling requirements. We have been making cutterheads since 1980 and can offer an ideal tool solution for every application and feed speed such as conventional, hydro or PowerLock clamping systems. The HSS, stellite or carbide knife materials and cutting geometries are adapted exactly to the requirements of your material. We set standards with bore tolerances of H7 quality and G1 balance quality for the production of tool bodies. We can make you even more efficient with our Rondamat tool grinder program. The WEINIG system has one objective only: to create the conditions for you to supply perfect workpieces.

# PowerLock: Flexible and fast for high productivity

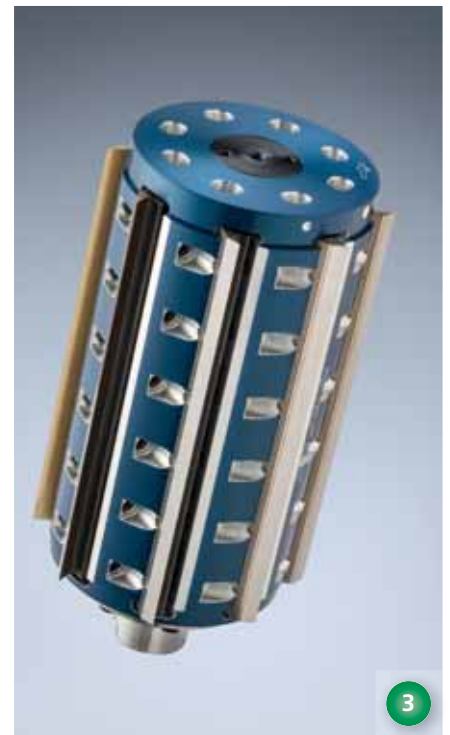

Long setup times cost time and money. With the original WEINIG PowerLock system you can set up in seconds and increase your productivity compared to standard tools. Press a button to release the cutterhead, remove it, insert a new cutterhead and press a button to clamp it. That's all. The immense rigidity of the monolithic HSK system makes high RPMs possible up to 12,000 rpm and offers excellent true running accuracy. Even with 310 mm working width no outboard bearing is required. All of this without compromising surface quality. Irrespective of whether you want to produce small batches or long production runs.

PowerLock is available in varying options for a wide range of cutting systems, working widths and applications. This tool system is famous the world over and is produced strictly according to WEINIG's high quality standards

Various tools and accessory options are available on the basis of the PowerLock system:

1. Original WEINIG PowerLock profile cutterhead type 538 with clamping screws
2. Original WEINIG PowerLock profile cutterhead type 538 with clamping screws
3. Original WEINIG Dual planing/profile cutterhead type 538



For more information,  
go to [film3.weinig.com](http://film3.weinig.com)



# WEINIG knife grinding systems: More flexibility and independence



Grinding, sharpening and creating profiles with the Rondamat:

- **Rondamat 960**  
Manual production and regrinding of profiling and straight knives using templates, maximum true running accuracy, numerous options
- **Rondamat 980**  
Fully automated for regrinding straight planing knives and solid cutter heads of all kinds
- **OptiControl**  
Exact measurements of tools such as planing and profiling cutterheads, solid cutter heads and saw blades. The measurements can be transferred to the machine

The Rondamat tool grinder rounds off WEINIG's production system perfectly. Producing profile knives and re-sharpening cutterheads on site makes you flexible and independent. You will benefit from shorter setup times and higher productivity. You can create a profile template at 1:1 scale from a drawing or an existing profile. Using this template you can profile the knife blank in a few minutes on the Rondamat 960. With the appropriate grinding wheels you can produce and sharpen HSS, stellite or carbide knives. The OptiControl measuring system will then determine the tool and profile data you need. This information is automatically transferred to the machine PC, which saves the values and provides these via the PowerCom controls to the spindles.

# PowerMech: Tailor-made performance



Thinking in terms of complete systems is considered in the development of WEINIG moulders right from the start. We have designed the PowerMech automation system for the Powermat 2400. Everything from a single source and adapted exactly to your needs, the PowerMech modules are the key to maximum profitability and top productivity. The functional units range from an infeed or outfeed system through scanning and conveying to packing and stacking. With the high level of automation you can decide how far you want to exploit the amazing capabilities of your Powermat 2400. The modular system is flexible and will grow with your needs. Whether fast throughput with fewer operators, linking several workstations, greater ease of use or more safety – PowerMech always offers a customized solution to fit around your Powermat.

The PowerMech system performs every task perfectly, both upstream and downstream of your Powermat:

- Destacking
- Feeding
- Buffering
- Visual grading
- Sorting
- Stacking packs
- Transporting
- Packing
- Stacking

...and much more



For more information,  
go to [film8.weinig.com](http://film8.weinig.com)

# WEINIG quality: The sum of many properties



Not many companies succeed in becoming a brand. WEINIG has succeeded in doing so. Trust plays a central role here. And the ability to prove this trust on a daily basis with our customer. We do this with quality. From product development to our supply of spare parts, from materials used to our worldwide service network. Based on employees noted for their expertise and passion for the product. Utmost care in assembling machines is part of this, as is continuous training. In order to maintain WEINIG's high standards we focus on vertical integration and independent quality management. Based on the world famous kaizen method, our production undergoes a continuous optimization process.

But WEINIG quality also means aligning production for the future with open machine systems, energy efficiency and sustainability. All these characteristics blend to create a product praised by our customers around the globe as outstanding. We call it 100% WEINIG quality.



For more information,  
go to [film6.weinig.com](http://film6.weinig.com)



# WEINIG service: Very close to customers



Customer relations are good. But we have a better word for it: WEINIG service. Supported by people who want to share their enthusiasm for wood with others. And when experts start talking together, a solution is not far away. This is why WEINIG service focuses on dialog with you, on outstanding training and a local support presence. The global WEINIG service network is so densely spread like no other in the sector. For you this means easy communication in your own language and rapid help. Whether by telephone or by a technician on site. We are here for you when you need it. You can order any spare part you need via the hotline for rapid delivery - even old models.

You will be advised in detail by a professional WEINIG expert in your country. In our individually tailored training programs you can find out how to optimally exploit the capabilities of your machine. Our specialists are always open to your production tasks.

- Subsidiaries in all continents of the globe
- Local WEINIG expert who speaks your language
- Mobile team of over 300 service technicians
- Spare parts via the hotline
- Professional advice by specialists via the hotline
- 6 day service
- Individually tailored training program
- Service agreements on request
- International ExpoCenter
- Financing to suit your needs



# Technical data

WEINIG planers and moulders offer a variety of spindle configurations. This means they can be specified perfectly to your particular application. The spindle sequences shown only cover one part of our flexible systems. Your WEINIG expert will be happy to advise you.

Please note: The dimensions given here are the values for a standard machine. Other configurations are possible with options such as improved sound insulation, a longer straightening table or modified position of the control cabinet, for example.

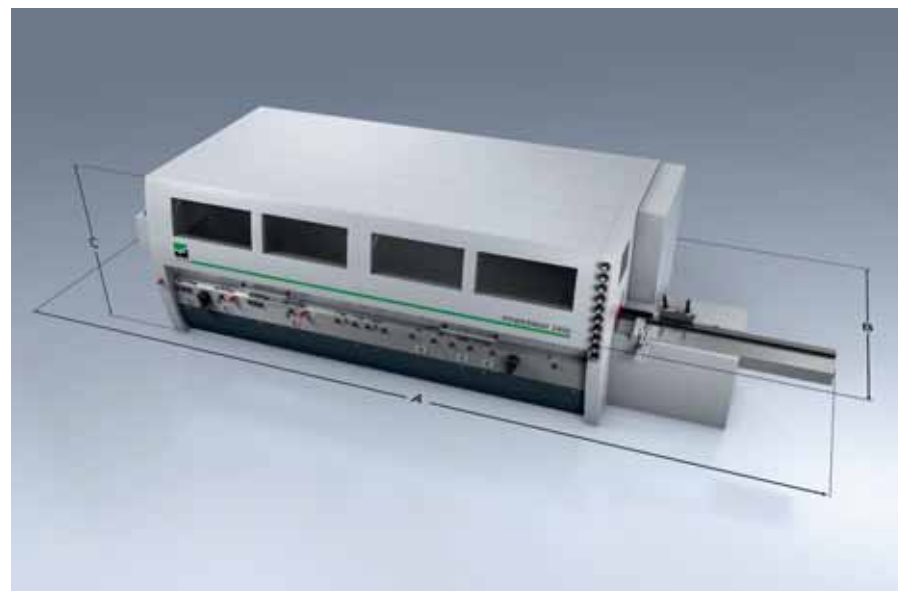

017

A = 4,528 mm, B = 2,125 - 2,200 mm, C = 1,740 mm



018

A = 5,078 mm, B = 2,125 - 2,200 mm, C = 1,740 mm



019

A = 4,578 mm, B = 2,125 - 2,200 mm, C = 1,740 mm



010

A = 5,078 mm, B = 2,125 - 2,200 mm, C = 1,740 mm



A = 1,000 mm, B = 2,340 - 2,415 mm, C = 1,740 mm

From left to right:  
Cleaving unit  
Saw spindle  
Universal spindle



A = 5,868 mm, B = 2,125 - 2,200 mm, C = 1,740 mm



A = 5,048 mm, B = 2,125 - 2,200 mm, C = 1,740 mm



A = 5,398 mm, B = 2,125 - 2,200 mm, C = 1,740 mm



# Technical data

Working height min./max. 10/160 mm	●
Working height min./max. 10/200 mm	○
Working width min./max. 20 - 230 mm	●
Working width 30 - 260 mm, speed max. 8,000 rpm	○
Working width 30 - 310 mm, speed max. 6,000 rpm with outboard bearing	○
Working width 30 - 310 mm, speed max. 8,000 rpm with PowerLock	○
6,000 rpm	●
8,000 rpm / 12,000 rpm / 10,000 rpm in connection with jointer	○
4,000 - 12,000 rpm, can be regulated electronically (only in connection with PowerLock)	○
Memory Plus	●
PowerCom Plus	○
Electronic displays	●
CNC-controlled axes	○
Pressure shoe in front of upper tool holder / left spindle, pneumatically swivels away	●
Max. tool diameter (not first bottom) 250 mm	●
PowerLock tool holder	○
Universal tool holder	○
Hydro outboard bearing	○
Straight jointer / automatic, profile jointer fully automatic	○
Frequency controlled feed speed 6 - 36 m/min	●
Frequency controlled feed speed 6 - 60 m/min / 8 - 80 m/min / 8 - 100 m/min (150 m/min on request)	○
MarathonCoating for machine tables	●
Max. motor power on vertical spindle (standard – option)	7.5 - 15 kW 21 kW via frequency inverter
Max. motor power on horizontal spindles (standard – option)	7.5 - 37 kW
Improved sound enclosure	○

● Standard ○ Option

Subject to technical alterations. The statements and pictures provided in this brochure also include optional equipment that is not included in standard delivery. Some protective covers were removed for photographing.







MICHAEL WEINIG AG  
Weinigstraße 2/4  
97941 Tauberbischofsheim  
Deutschland

Telefon +49 (0) 93 41 / 86-0  
Fax +49 (0) 93 41 / 70 80  
E-Mail [info-profiling@weinig.com](mailto:info-profiling@weinig.com)  
Internet [www.weinig.com](http://www.weinig.com)