

An all- rounder for timber construction.

HC WEINMANN

Our multifunction bridges

WALLTEQ M-120

WALLTEQ M-300/320

WALLTEQ M-340/380

YOUR SOLUTION







WALLTEQ multifunction bridges — Fast, precise and versatile

These CNC-controlled machines allow you to carry out all work on the sheathing of wooden frame elements in a fully automatic process — including, for example, fixing, formatting and production of all openings. Regardless of whether you are working with wall, roof, ceiling or gable elements, these machines can be used in all areas. Both small and large quantities can be produced efficiently and with high precision.

YOUR SOLUTION

MORE: [HOMAG.COM/WEINMANN](https://www.homag.com/weinmann)

CONTENTS

- 06 Base equipment and options
- 08 WALLTEQ M-120 and options
- 10 WALLTEQ M-300/320 and options
- 12 WALLTEQ M-340
- 14 WALLTEQ M-340 — Options
- 16 WALLTEQ M-380
- 18 WALLTEQ M-380 — Options
- 20 WALLTEQ M-380 — Special areas of application
- 21 WALLTEQ M-300/M-380 insuFill
- 22 Machine layout and technical data
- 24 Configuration options
- 26 Software
- 28 tapio
- 30 Service

Flexibility in wood frame construction

The multifunction bridges are versatile and can be expanded on an individual basis. Depending on the performance and product range required, different versions are available to suit your requirements.



Multifunctional

- Process a wide variety of materials without setup times
- Equipped for the future: The modular design makes it possible to adapt to changing market requirements at any time
- Depending on the design, the machines can be configured according to the customer's individual needs

Proven technology

- CNC controller for fully automatic processing
- Interpolating processing
- Durable design
- Low maintenance thanks to the central lubrication system and toothed belt drive

Powerful complete package

- Optimum working ergonomics and work safety
- Fully automatic data transfer from CAD
- Increased efficiency thanks to structured production processes



	WALLTEQ M-120	WALLTEQ M-300/320	WALLTEQ M-340	WALLTEQ M-380
	Produce small quantities profitably	Basic machine for production lines	Versatile	Individually configurable
Fastening	Stapling, nailing			Stapling, nailing, screwing
Processing	Routing	Routing or sawing	Routing, drilling, sawing	
Labeling	–	Marking, labeling		
Tool changer	–	–	12-part	12-part
Fastener chucks	2	1, optionally 2	1, optionally 2	Individual

Investment in the future

This machine lets you process a wide variety of elements and materials in a fully automatic process, putting you in the optimum position for producing batch size 1 and for meeting future requirements. Even with the standard features alone, the machines in the WALLTEQ series are equipped with a range of helpful details.

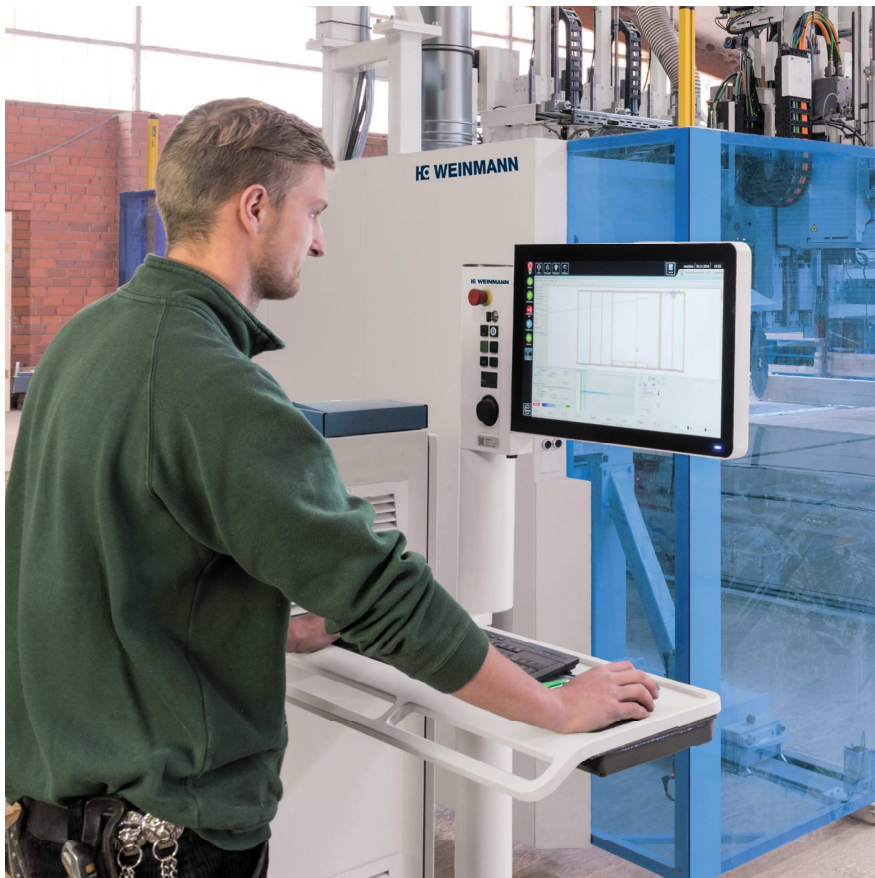

Your step into digitization

- Fully automatic data transfer from all common CAD programs for wood work
- Easy to operate with intuitive powerTouch user interface
- tapio-ready: all the processes in the value chain combined into a single digital platform
- Continuous data flow from data generation to the finished product (part of the BIM process chain)



Modern production technology

- Extensive processing capabilities thanks to versatile tool change technology
- CNC technology for consistently high accuracy
- Reduced maintenance effort thanks to central lubrication



The highest safety standards

- 8 Light barriers and 4 bumpers
- Protected working area, both on the assembly table and on the side of the assembly table



Individual production concepts

- Can be combined with different table concepts; several tables can also be approached
- Can be integrated into a production line at any time

Features to suit your needs

There are a range of options that can be integrated into any multifunction bridge allowing you to find your solution by configuring the machine specifically to your needs.



Central extraction system

- Minimize the amount of dust
- Optional: separation of different materials is possible



Piggyback suction device

- Compact, cost-effective suction unit
- Primarily suited to wood dust
- Automatic filter cleaning with the air jet system

fastenerSwitch: quick change system for fastening units

- Fully automated exchanging of different fastening units
- More flexibility: the system provides up to 4 different fastening units
- Minimized downtimes and increased efficiency



Activation with remote control

- Start the machine from various positions
- Shorter walking distances and optimal work flow



Modules for the power supply and switch cabinet

- Uninterrupted power supply to safeguard the control computer
- Switch cabinet heating
- Switch cabinet cooling

WALLTEQ M-120 multifunction bridge — Small quantities produced profitably

The WALLTEQ M-120 is the ideal entry-level solution for CNC-controlled manufacturing in the field of home building. Elements in wood frame construction can be manufactured quickly and easily — and all of this comes at an outstanding price-performance ratio.

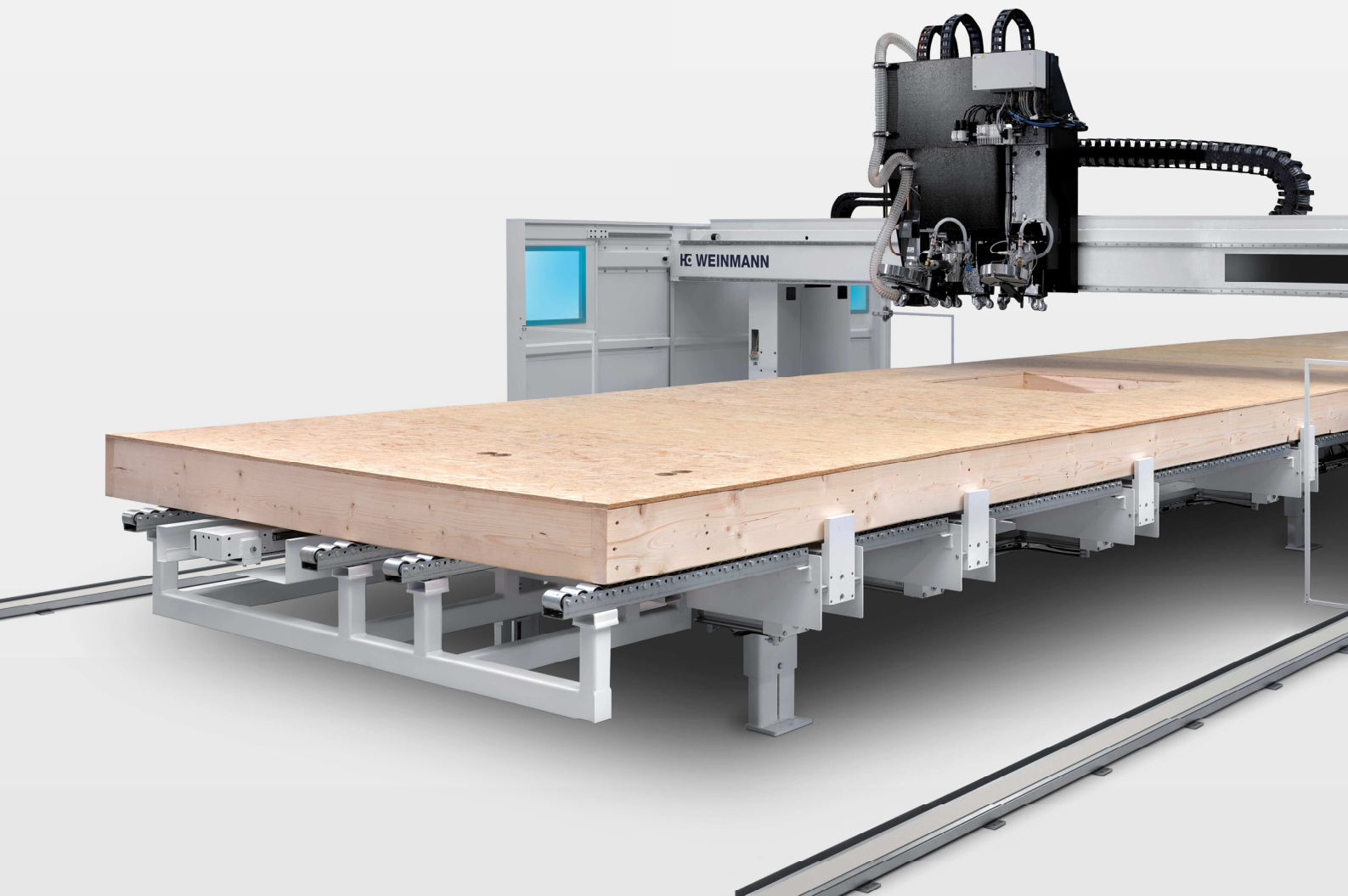

“We work to a high level of quality and our production is about 30 percent faster than manual production, even with the same number of employees.”

Christoph Bächle, Abbundzentrum St. Johann

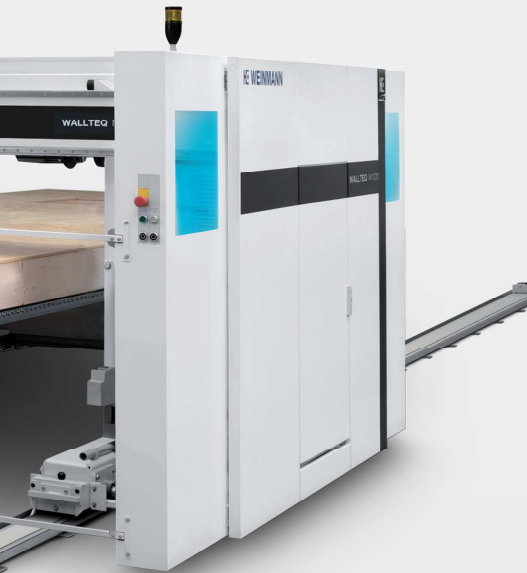

Fastening of sheathing



Interpolating routing processing



Formatting outer edges

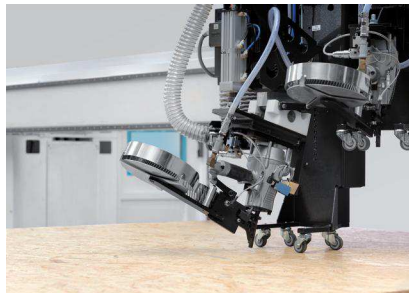

Option: swiveling chuck for nailing devices



Option: fast data entry directly at the machine with easyRUN

Fully automatic processing with routing unit

- The manufacture of window, door and socket cut-outs
- Tracking of and compensation for thickness variations in the element with scanning routing unit
- Fully interpolating routing of free-formed pieces such as circles, arcs or gable slopes

Two chucks for attachment devices

- Automatic fastening of sheathings by two different staple or nailing devices
- Ensures static equilibrium by guaranteeing the correct border and attachment clearances

HIGHLIGHTS:

- Entry-level solution with extremely very low acquisition costs
- Flexible manufacturing of various elements for production in batch size 1
- Fast and direct data input with easyRUN in addition to fully automatic data transfer

WALLTEQ M-300/320 multifunction bridge — The basic machine for production lines

The WALLTEQ M-300/320 is the ideal machine for use in production lines. Equipped with a fastening unit and, depending on the customer's requirements, a routing or sawing unit, it can be used to perform all processing steps on wall, roof and ceiling elements. The high processing speed coupled with the ability to customize equipment makes this machine perfect for use in production lines.

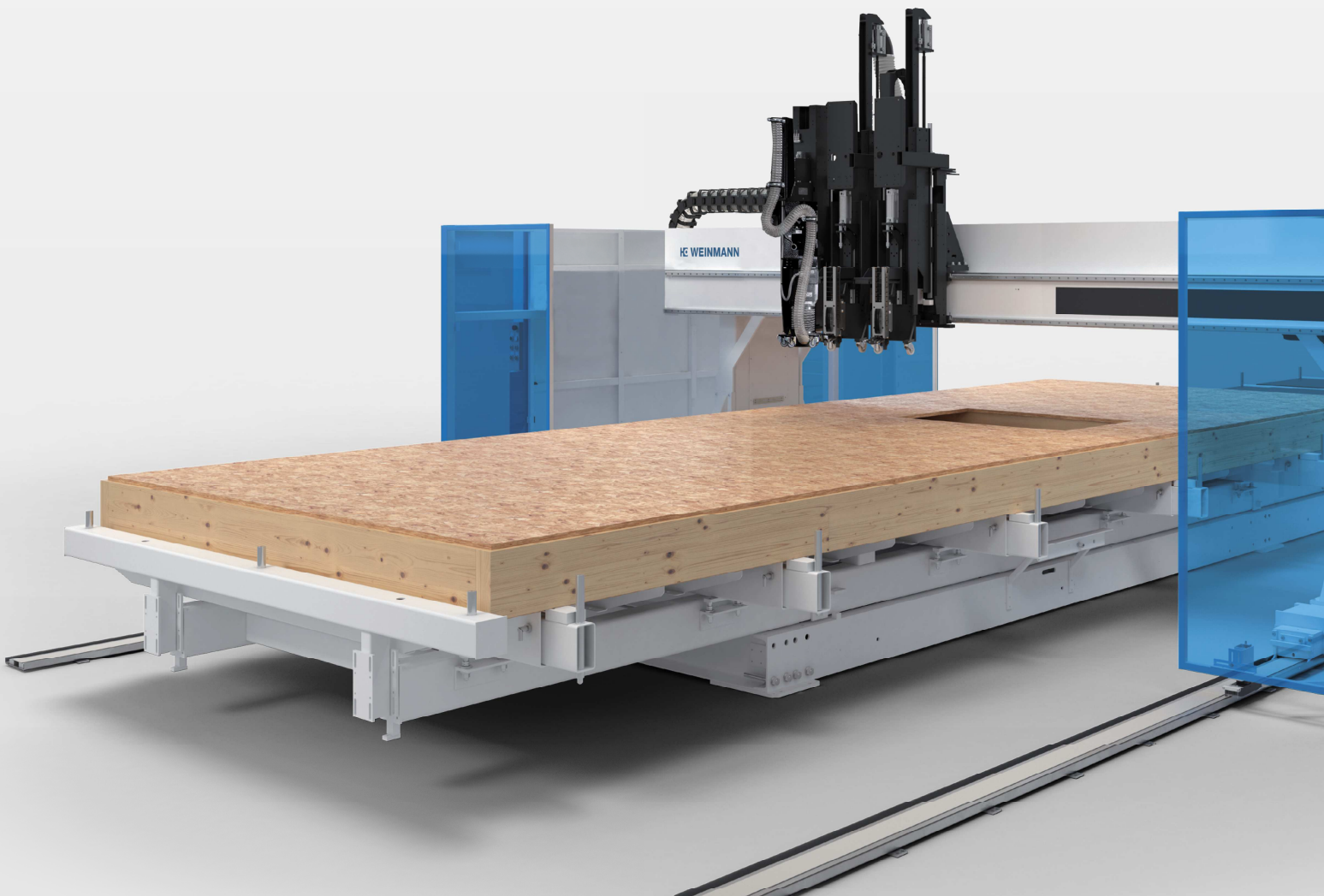

“I see the restructuring and the new production technology as important course markers that will prepare my company for further growth in the next few years.”

Andreas Gamper, Gamper Holzbau — Bauprojekt GmbH, Germany

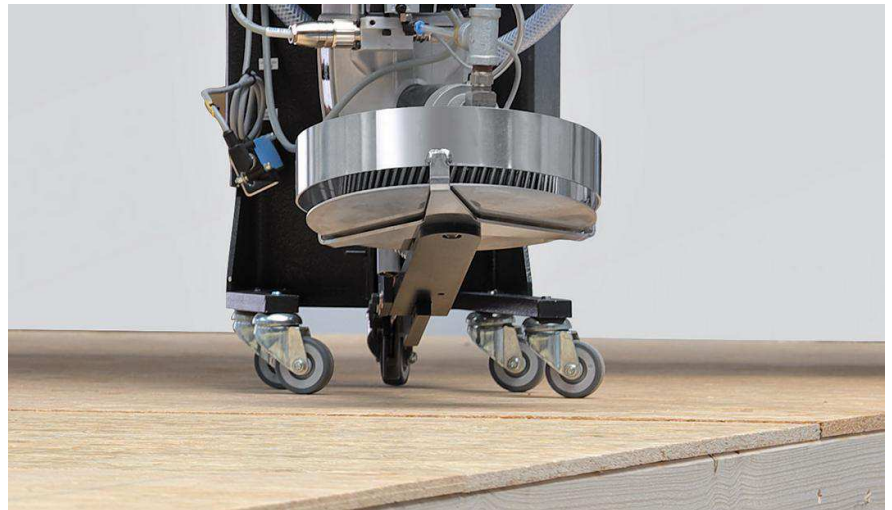

Fastening of sheathing

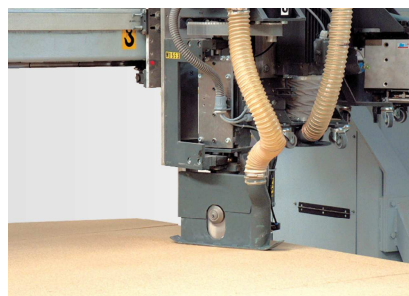

WALLTEQ M-300: fully automatic processing with the sawing unit

- Up to 65 mm cut depth
- Saw protection with integrated extraction technology

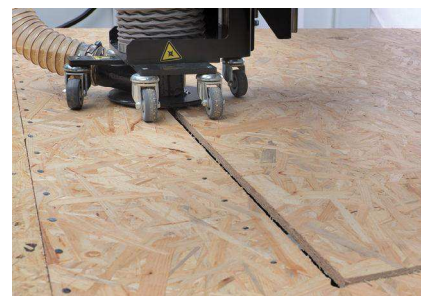

WALLTEQ M-320: fully automatic processing with the routing unit

- Up to 90 mm depth
- Routing protection with integrated extraction technology

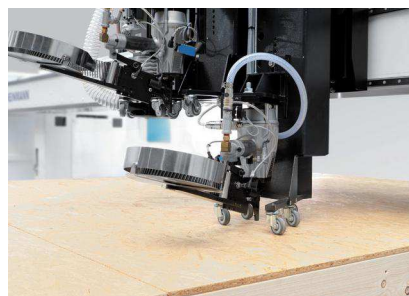

Optional expansions (not all options can be combined):

- Second fastening unit
- Sliding shoe
- Batten shoe
- Nail pusher
- Swiveling chuck for nailing devices

HIGHLIGHTS:

- Fully automatic data transfer
- Ideal for use in production lines
- Comprehensive safety technology

WALLTEQ M-340 multifunction bridge — Versatile

The WALLTEQ M-340 is a true all-rounder for timber frame construction and can be expanded according to individual needs. The integrated 12-slot tool changer will provide you with the right tool for the job whenever you need it, in no time at all. As a result, setup times are reduced to a minimum and efficiency is increased.

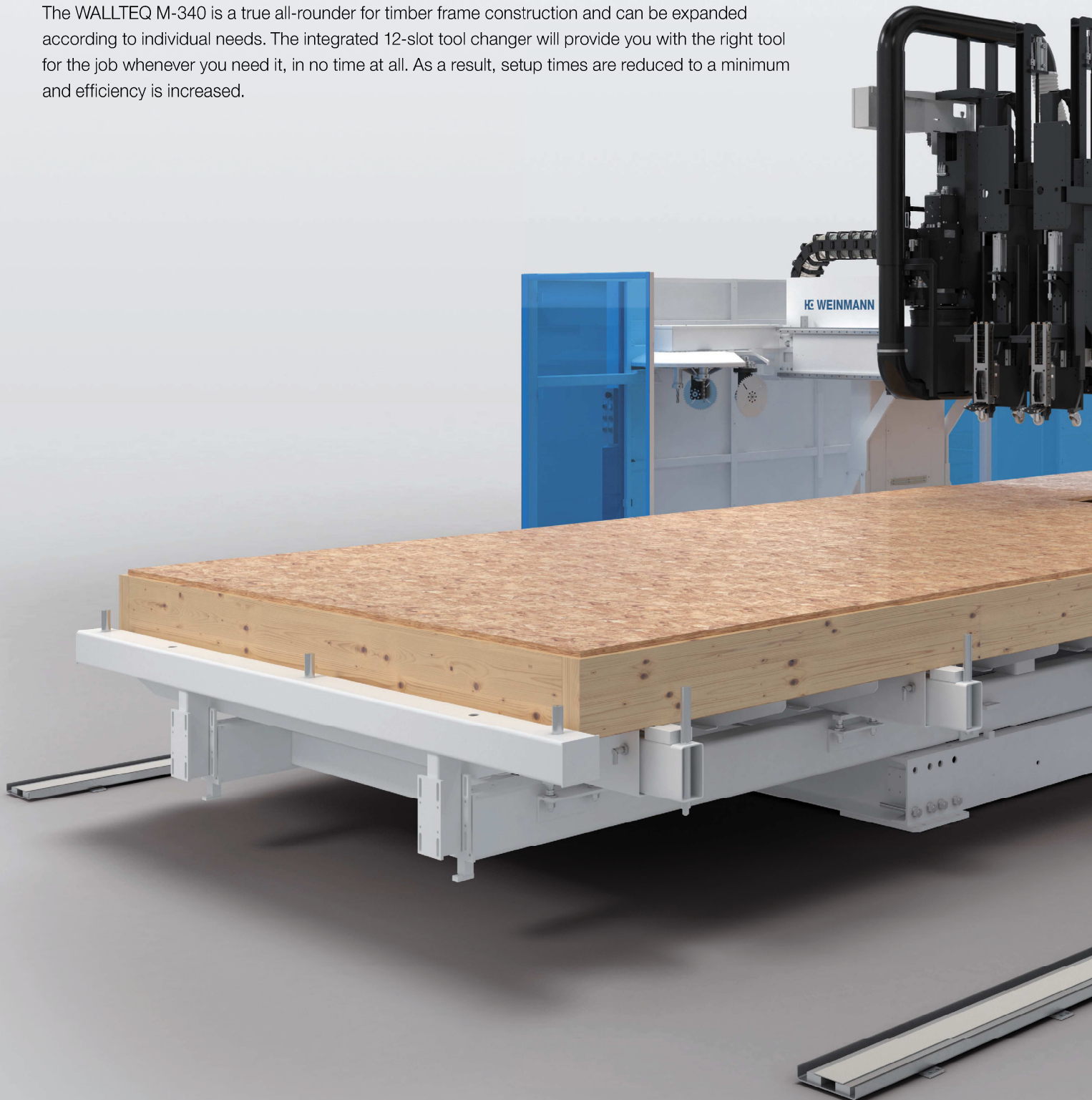



“The level of effort involved in work preparation has increased. However, this effect is more than compensated for by the shorter production and assembly times that have become possible thanks to the increased component precision and level of prefabrication.”

Daniel Hamdorf, Zimmerei Hamdorf, Fahrenkrug

WALLTEQ M-340 — Base equipment

Equipped with a 12-slot tool changer, the WALLTEQ M-340 is ideally suited to the manufacture of high quality wall, roof and ceiling elements in high quality. The fixing, sawing, routing and drilling takes place fully automatically.

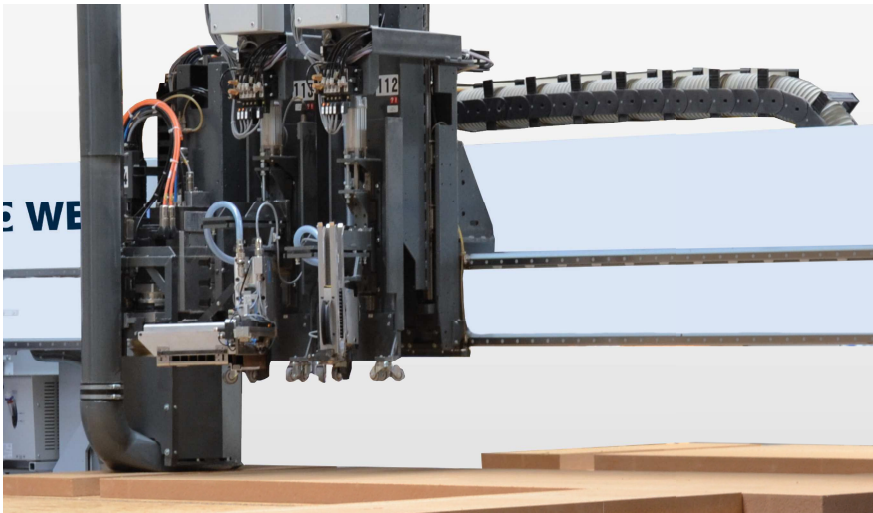

Processing soft wood fiber



Manufacturing window openings



12-slot tool changer



Tool set

- Sawing up to 80 mm cut depth
- Routing up to 55 mm
- Drilling up to 180 mm



Fastening of sheathing

Fully automatic tool change technology

- Quick setup times: Space for up to 12 tools in the tool changer
- 18.5-kW main spindle for a high chipping rate
- Extensive processing such as sawing, routing, drilling
- Separate the sawing unit in pick-up station for cutting depths of up to 135 mm

Fastening units:

- Different staple or nailing can be used, manufacturer-independent
- The highest speeds: fastening with up to 8 staples per second

HIGHLIGHTS:

- 12-slot tool changer
- Unlimited tool options
- High performance and flexibility

WALLTEQ M-340 — Optional features

These modules allow you to configure the machine according to your requirements.



Marking and labeling

Marking of panel joints, slat positions, or shuttering boards enables fast and easy positioning.

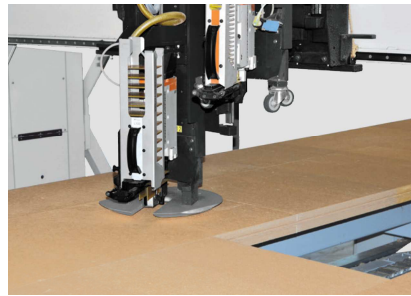

Sliding shoe for attachment devices

Fastening to protect the material, especially suitable for soft wood fiber.

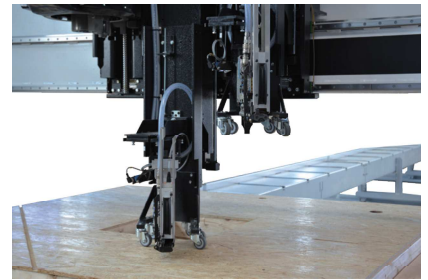

Chuck for a second fastening unit

Different fastening units enable the attachment of various types of sheathing material.

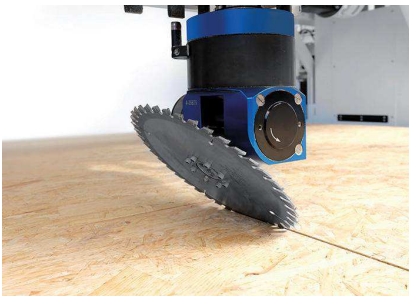

Flex 5 sawing unit

- Sawing angles (0–60°)
- 0–45°: up to 55 mm panel thickness

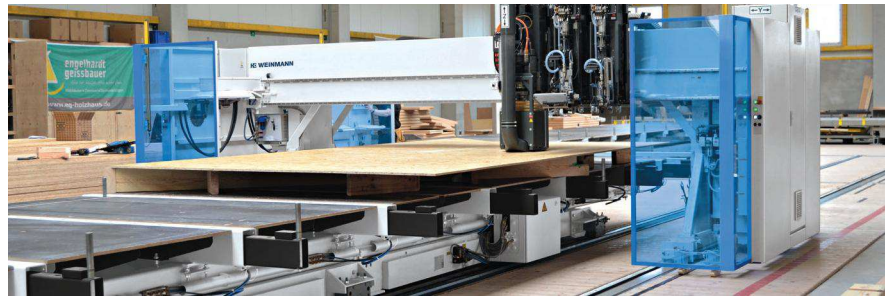

Increased dynamics

- Faster processing with consistently high accuracy
- A significant advantage, especially when it comes to larger elements and longer travel paths

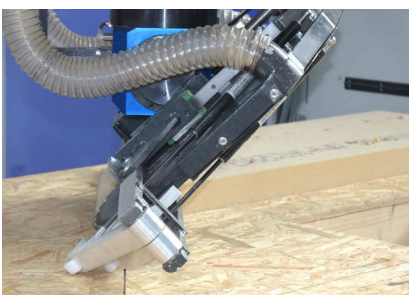

Sawing unit with a built-in protective cover and suction hood

WALLTEQ M-380 multifunction bridge — Configurable to individual requirements

With the WALLTEQ M-380, you are equipped for the future. The device carrier beams are configurable from both sides and have a maximum of 4 axis, offering space for up to 16 units and therefore affording you a wider bandwidth when processing. The WALLTEQ M-380 can be configured on an individual basis to fit your requirements to become your solution.

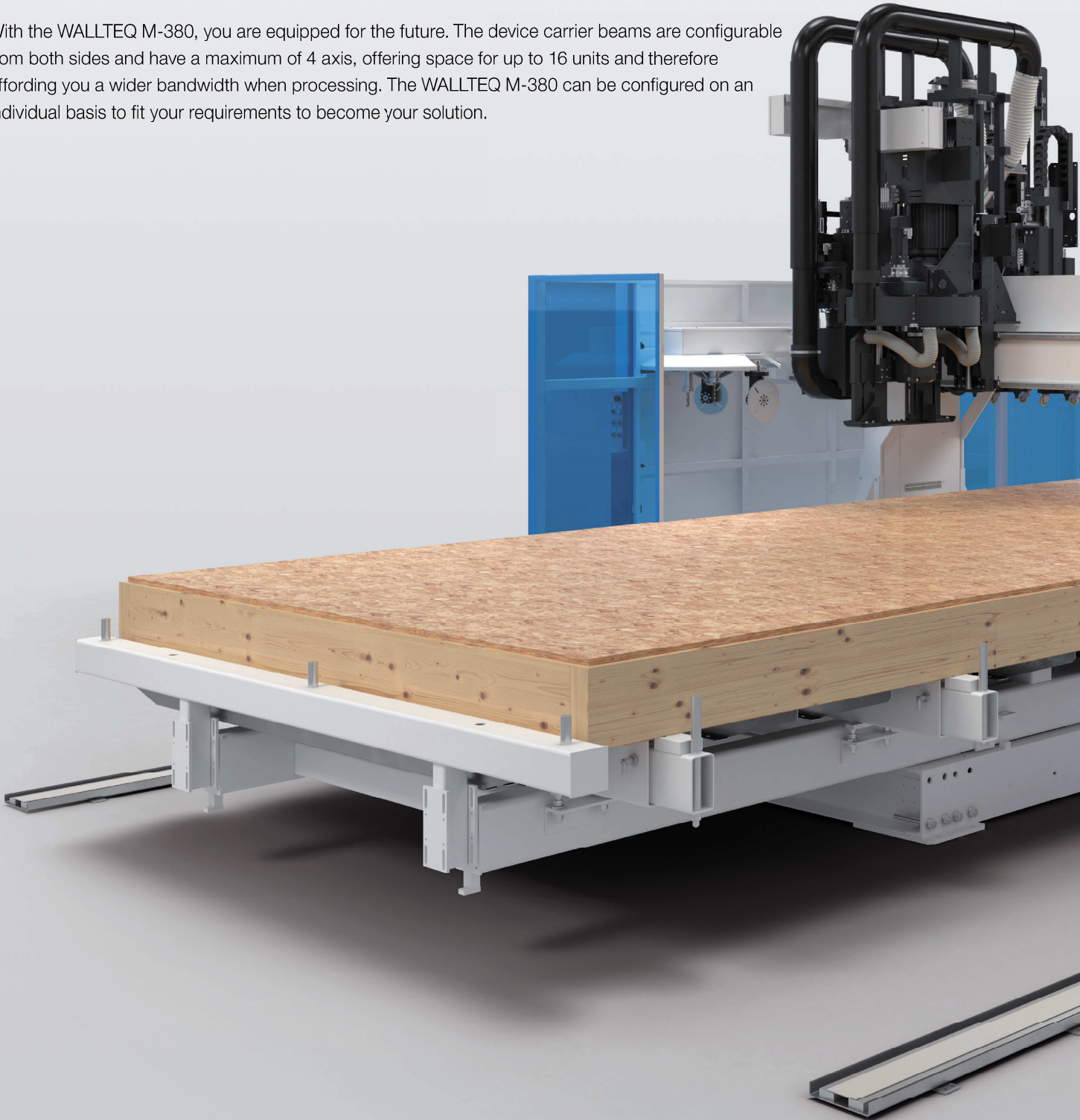

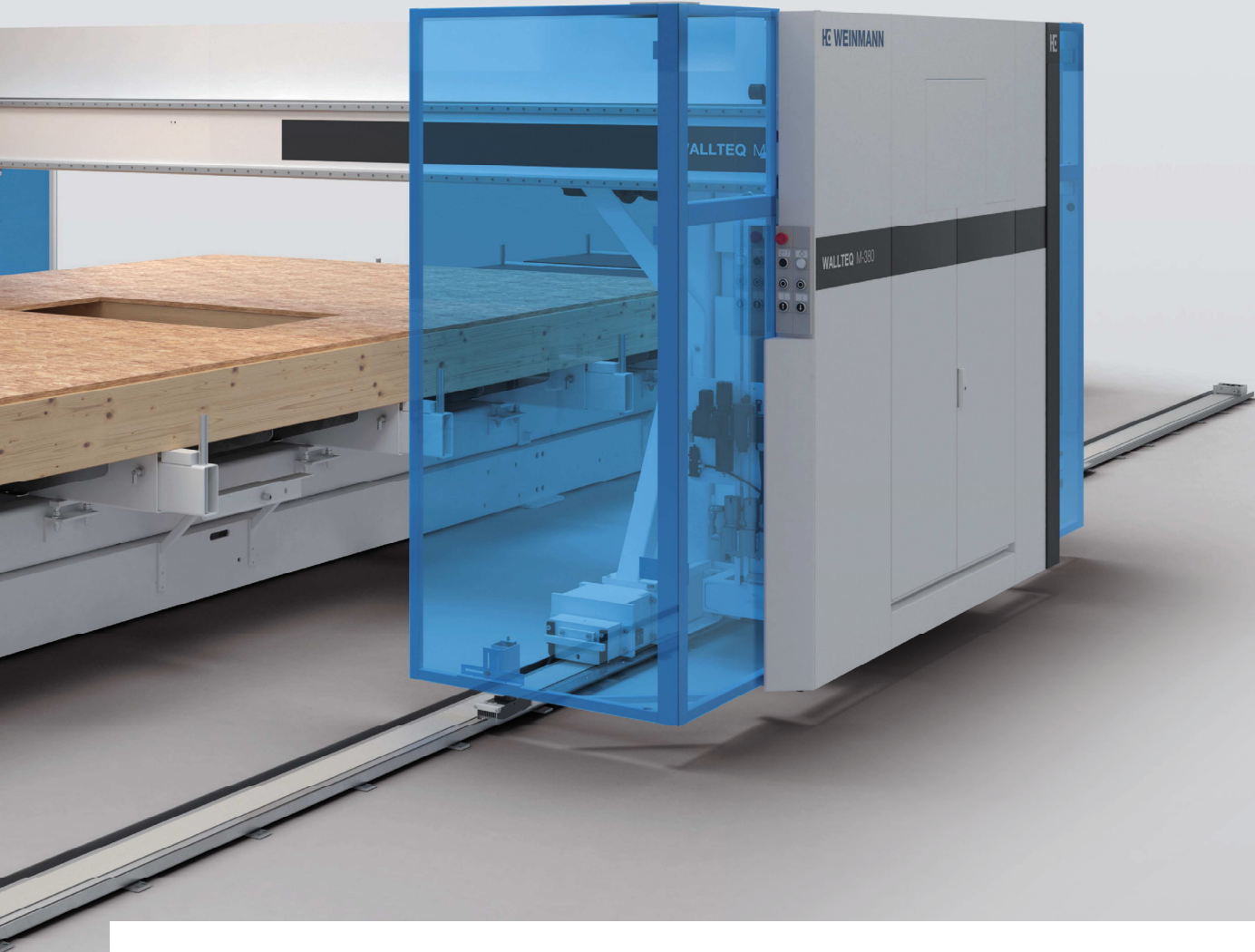

“The prefabrication allows us to reduce assembly times, providing us with a significant cost advantage. We were advised well, and the first plant operated smoothly right from the start.”

Jean-Luc Herrmann, Wolf System, Osterhofen

WALLTEQ M-380 — An incredible range of processing options

The additional processing units that are available with the WALLTEQ M-380 ensures that you as a customer are well positioned to meet any future requirements. The large number of possibilities are ranging from sawing and routing to drilling, marking and labeling.



Routing



Fully automatic sawing

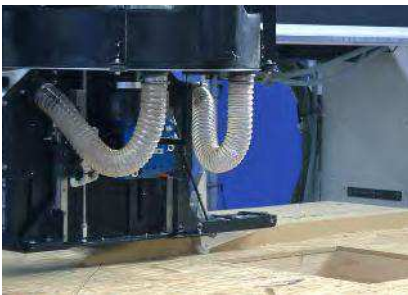

Flex 25 sawing unit

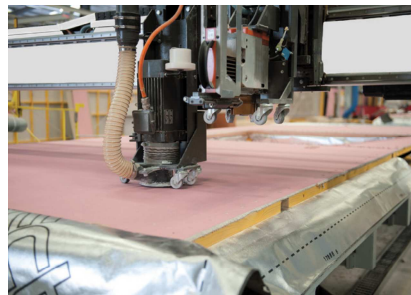

Processing gypsum plasterboard



Formatting the roof battens

Extensive processing options:

- 18.5-kW spindle for 12-slot tool changer
- Sawing, routing, drilling, marking, labeling
- Other sawing units: Flex 5, Flex 25

A wide range of materials:

- Soft wood fiber
- Gypsum plasterboard
- SIP
- Solid wood and CLT
- Facade panels
- And much more

HIGHLIGHTS:

- 12-slot tool changer
- Unlimited tool options
- High performance and flexibility

WALLTEQ M-380 — More options for fastening

There are also a wide variety of expansion options for fastening. In addition to staples and nails, for example, you can also use screws. It is also possible to increase performance with parallel fastening and nail pushers.

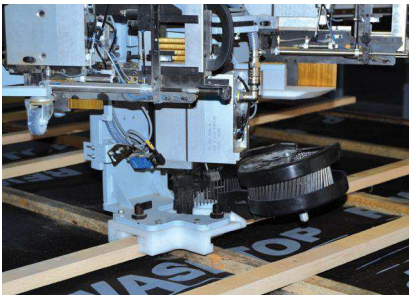

Batten shoe

Automatic batten positioning and fastening. Longitudinal and crosswise battens can be fastened with coil nailers.

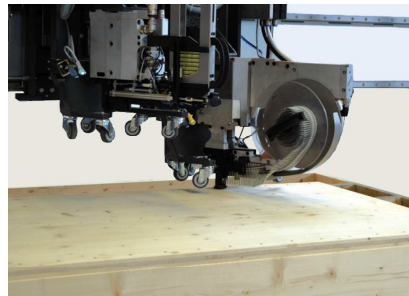

Nail pusher

Using the nail impression unit also significantly increases the quality of fastening. One common area of application is the fastening of gypsum plasterboard. Speed: 1.25 sec/nail

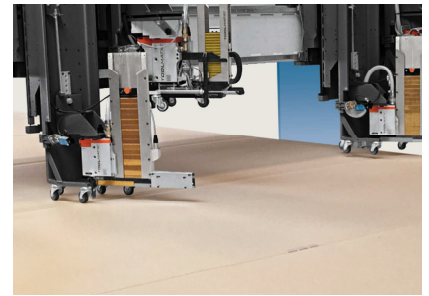

Parallel attachment

The sheathing is secured in parallel with two identical fastening units. Up to 40% higher performance can be achieved.



Screws

Fastening with screws suited for gypsum plasterboard or assembly panels. Only approx. 2.5 seconds are required per screw.

Automatic separation of loose screws with a length up to 250 mm.

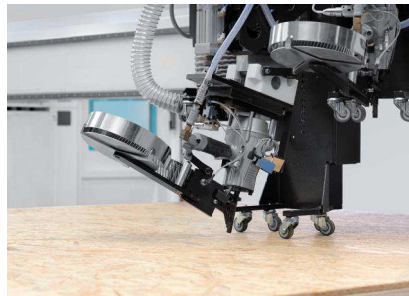

Swiveling units for nailing devices

- Swiveling unit for meeting the correct edge clearances, for example in the case of narrow studs or 2" x 4" construction method
- Horizontal swiveling to correctly attach soft wood fiber panels



Fastening shuttering boards

The attachment devices also allow you to automatically fasten panels for eaves shuttering.

HIGHLIGHTS:

- Staples, nails, screws, nail impressions
- Additional units for fastening to protect materials
- Automatic slat positioning and fastening

WALLTEQ M-380 — Special areas of application

The WALLTEQ M-380 demonstrates its multi-functionality capabilities in a host of other areas. The positioning and fastening of battens, pre-cutting of panels and gluing are just a few examples.

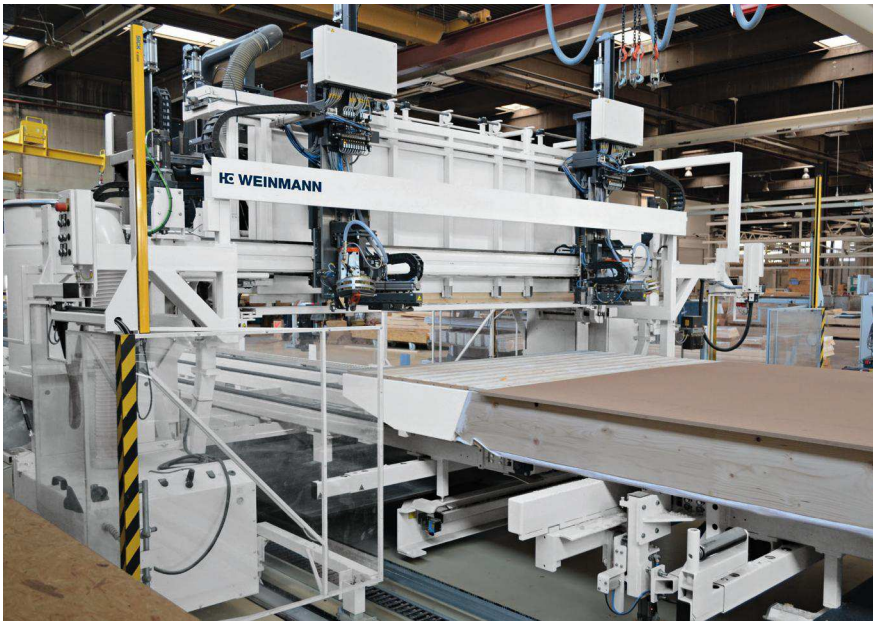

Fully automated positioning of battens

- Fully automatic fitting, positioning and fastening of the battens on the element
- Battens and shuttering boards with a size of min. 24 x 48 mm and max. 60 x 150 mm
- The capacity of the piggyback slat magazine is sufficient for a complete tier (12 m) of beam shuttering or exposed shuttering
- The batten magazine is filled manually or automatically



Fully automatic plate layout with nesting function

- Material savings and optimization of waste
- Manufacturing free contours without bars
- Also suitable for facade panels and other large-format panels such as CLT, sandwich or non-wood-elements

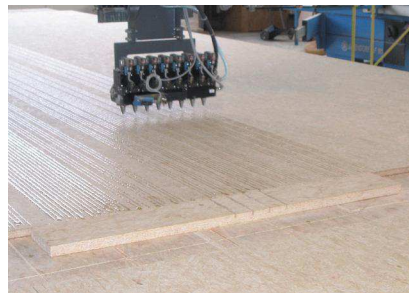

Gluing

Using a multi-nozzle system means that individual components and surfaces can be glued quickly.

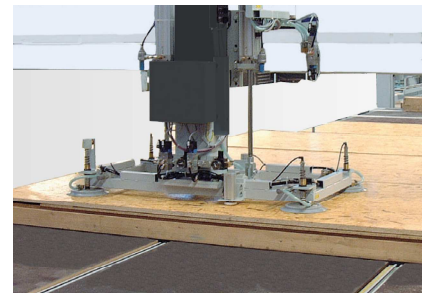

Automatic positioning of panels

The vacuum suction lifter mounted on the WALLTEQ automatically positions the panel materials on the element.

Multifunction bridge WALLTEQ M-300|M-380 insuFill – automated insulation.

The WALLTEQ M-310/M-380 insuFill allows the fully automated insulation of timber construction elements. The CNC-controlled multifunction bridge accurately moves the insulation plate exactly over the respective framework compartments. All specifications as the position, shape and size are stored in the CAD and transferred to the insulation plate via interface.



WALLTEQ M-300 insuFill - insulation station

- Fully automatic insertion of loose insulation material in wall, roof and floor elements as well as gable triangles or special elements
- Can be combined with any work table
- Fast flow times and shortened cycle times, suitable for medium-sized companies and industrial customers
- Optional: rotatable injection plate at 90° for floor and roof elements



WALLTEQ M-380 insuFill - allrounder for insulation and processing

- Fully automatic insertion of loose insulation material in wall, roof and floor elements
- Can be combined with any work table
- High flexible for small and medium-sized companies
- Optional: various processing and fastening options



Wide range of insulation materials

Loose insulation material such as cellulose, wood fiber and mineral wool can be insulated.



Optimum filling quantity

Automatic calculation of the filling quantity enables the optimal and consistent density distribution of the insulation material in each compartment.

HIGHLIGHTS:

- Quality assurance thanks to seamless documentation and verifiable fill quantities
- Optimal and uniform density distribution of the insulation per compartment
- Work processes become more pleasant since the volume of dust is significantly reduced
- Significant material savings, since there is no material waste
- High level of efficiency thanks to rapid and uniform insertion of the insulation

State-of-the-art technology for your production

Since it can be combined with individual table concepts and a travel path of up to 50 m, the WALLTEQ is even able to process the largest element dimensions, which means that you will also benefit from a high level of durability and availability. High safety standards are guaranteed by light barriers and motion detectors.

WALLTEQ M-120

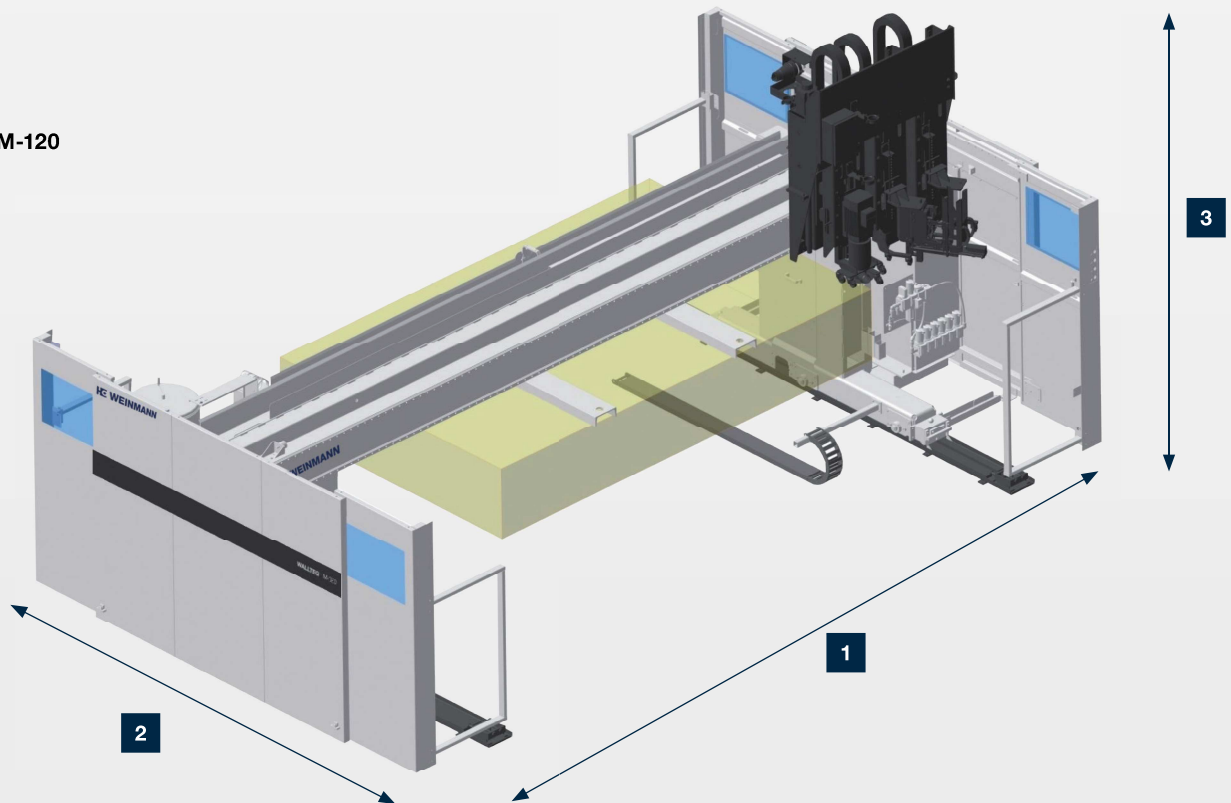

WALLTEQ M-300/320/340/380

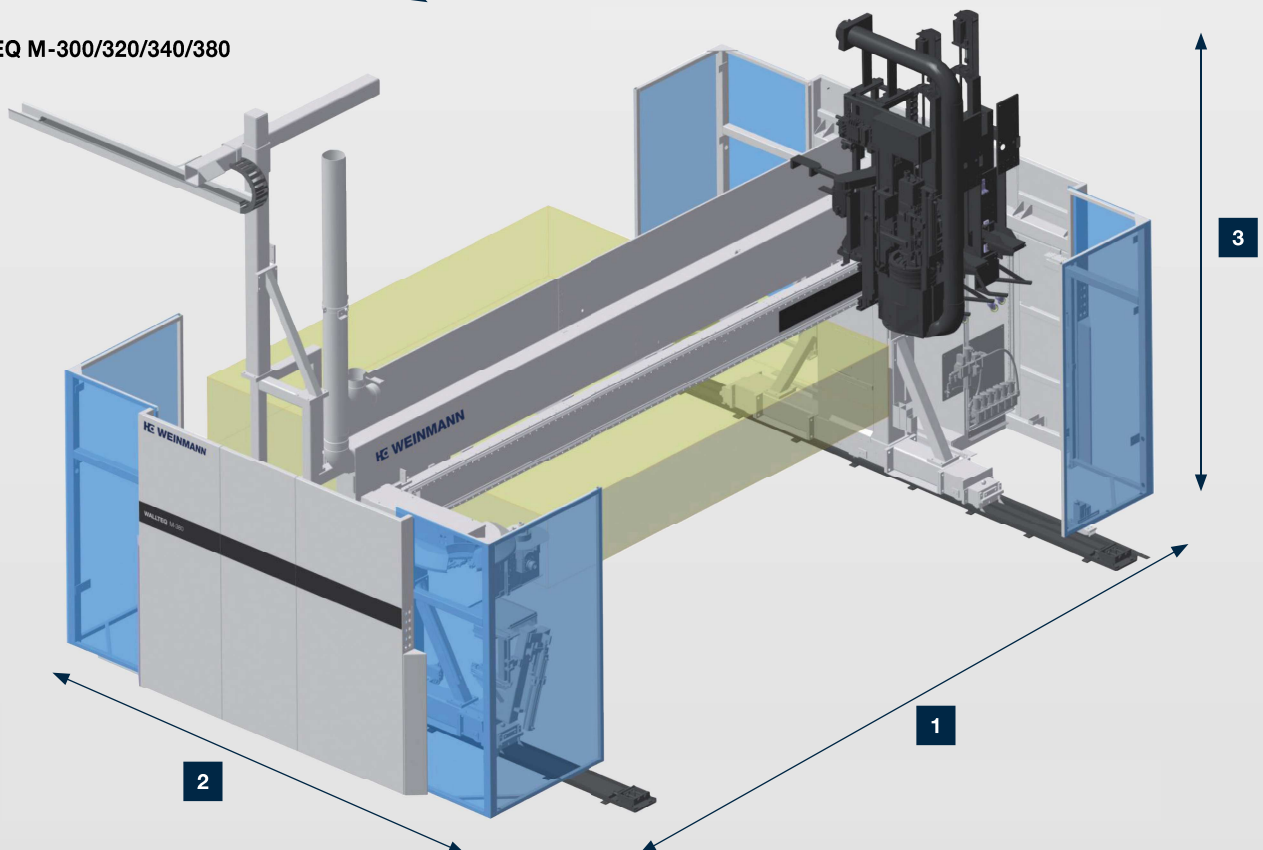

MACHINE DIMENSIONS	WALLTEQ M-120	WALLTEQ M-300/320	WALLTEQ M-340	WALLTEQ M-380
1 Width (mm)	6,025	6,370	6,370	6,860/6,330
2 Length (mm)	3,655	3,700	3,700	3,330/3,850
3 Height (mm)	2,820	3,450	3,450	3,450
Weight (tons)	2.9	4.0	4.0	5.0

PRODUCT DIMENSIONS	WALLTEQ M-120	WALLTEQ M-300/320	WALLTEQ M-340	WALLTEQ M-380
Width (mm)	3,600	3,200	3,200	3,200/4,200
Length (mm)	Customer-specific up to 50,000			
Height (mm)	500			

TECHNICAL DATA	WALLTEQ M-120	WALLTEQ M-300/320	WALLTEQ M-340	WALLTEQ M-380
Processing depth (mm)	Up to 60 depending on the material	Sawing up to 64 Routing up to 90	Up to 195 depending on the tool	
Piggyback suction device performance (m ³ /h)	720	1,850		
Central extraction system performance [m ³ /h]	850	2,200		
Electrical connection value (kW)	18		20–30	20–40
Compressed air connection value (NI/min)	1,500			
Pneumatic pressure (bar)	8			

Configuration options

The choice is yours. The available options provide you with a wide range of possibilities to adapt your multifunction bridge according to the requirements of your production. In the table you will find an overview of the options that are possible in the respective machine types.

	WALLTEQ M-120	WALLTEQ M-300/320	WALLTEQ M-340	WALLTEQ M-380
Extraction concepts				
Piggyback	✓	✓	✓	✓
Central extraction system	✓	✓	✓	✓
Energy chain				
On the floor	✓	✓	✓	✓
On consoles at a height of 4–4.5 m	✓	✓	✓	✓
Embedded in the floor shaft		✓	✓	✓
Handling				
Remote control		✓	✓	✓
Piggyback feed adjustment		✓	✓	✓
Machine				
Bridge expansion				✓
Travel path extension	✓	✓	✓	✓
Increased accuracy		✓	✓	✓
Increased dynamics		✓	✓	✓
Cooling unit	✓	✓	✓	✓
Switch cabinet heating	✓	✓	✓	✓
Units				
Additional units beam				✓
Gluing unit				✓
Blowing plate construction/preparation				✓
Panel positioner				✓
Automatic batten positioner				✓
Semi-automatic batten positioner		✓	✓	✓
fastenerSwitch - quick change of fastening units	✓	✓	✓	✓
Pickup station			✓	✓
Label printer		✓	✓	✓



	WALLTEQ M-120	WALLTEQ M-300/320	WALLTEQ M-340	WALLTEQ M-380
Fastening units				
Second fastening unit	✓	✓	✓	✓
Parallel attachment				✓
Sliding shoe for soft wood fibers		✓	✓	✓
Nail pusher		✓	✓	✓
Swiveling nailer in the X direction				✓
Swiveling nailer in the Y direction	✓	✓	✓	✓
Automatic height adjustment of the fastening units		✓	✓	✓
Screw unit				✓
Processing units – tool changer				
Spindle drive up to 18.5 kW			✓	✓
Spindle drive up to 26 kW				✓
Sawing up to 80 mm			✓	✓
Sawing up to 105 mm			✓	✓
Sawing up to 135 mm (pick-up station)			✓	✓
Drilling (tool-dependent)			✓	✓
Routing (tool-dependent)			✓	✓
Flex 5 sawing unit up to 55 mm			✓	✓
Flex 5 sawing unit preparation			✓	✓
Marking ballpoint pen		✓	✓	✓
Marking inkjet			✓	✓
Labeling inkjet			✓	✓
Processing units – single units				
Sawing up to 65 mm (1.5 kW)		✓	✓	✓
Flex25 sawing up to 195 mm (20 kW)				✓
Routing up to 60 mm (5.5 kW)	✓			
Routing up to 90 mm (6 kW)		✓		✓
Drilling up to 100 mm (4.4 kW)				✓

Software — The foundation for efficient production

Software is becoming an increasingly important factor in the use of machines. To enable shorter routes and realise customer requirements to the best possible extent, we develop the work preparation software and machine software completely in-house. Take advantage of our range of software modules that are perfectly tailored to your machine.

The advantages at a glance

- One software package for multiple machines
- Uniform operation of each WEINMANN machine
- Exceptionally user-friendly
- Easy to understand programs with a simple structure
- Software in your local language
- Complete solutions for the integration of the machine into the manufacturing process
- Coordinated modules
- Modern software architecture
- Free software updates



wupWorks 3

The wupWorks 3 software automatically converts WUP files created in a CAD program into CNC programs.

The corresponding data is displayed graphically as a 3D model. Fully automatic optimization cycles ensure the best results. The software also selects the correct tools automatically.

wupWorks work preparation

wupWorks work preparation allows you to optimize your production orders while you are still in the office. With the time simulation feature, you can determine the processing time and thus optimize your quotation, as well as data control and optimization. The software can generate unprocessed timber lists and automatically match tooling between the machine and the office.

- Less machine downtime thanks to elimination of data record optimization
- Shortening of machine throughput times

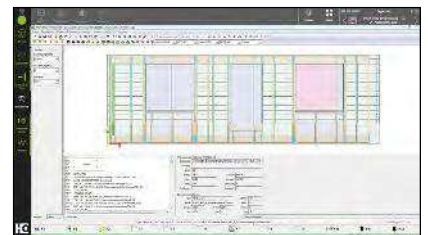

wupEditor Basic

In wupEditor, you can read a WUP or BTL file generated in a CAD program, convert it into a drawing and then edit this drawing. In addition, you can use macros to quickly and easily create or complete components and transfer components straight into wupWorks — without using a CAD system.

- Simple data checking
- Fast adjustment and expansion
- Easily create complete components using macro functions
- Create your own macro functions
- Minimal downtime during production; adjust the component directly at the machine
- Graphical 3D display

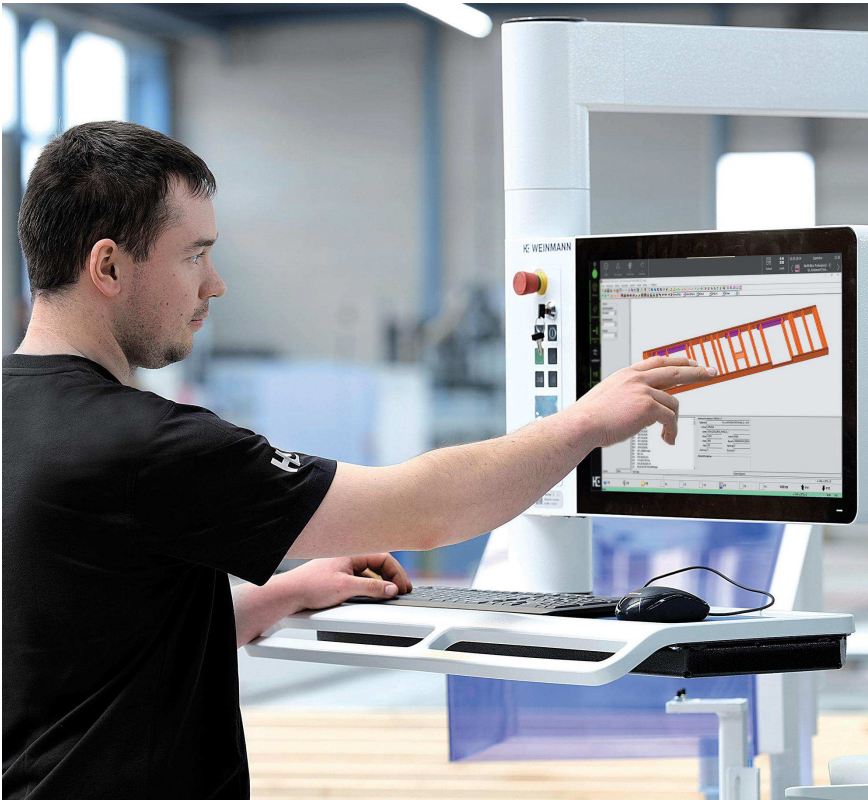

The next generation of powerTouch: **powerTouch2**

Faster, more comfortable, clearer:

Enjoy the benefits of our further improved powerTouch user interface.

- Direct and efficient operation, up to 30% faster
- Clearer and more informative thanks to additional information and live illustrations instead of program icons
- New applications for operating and controlling machines and systems (e.g. NCCenter in the PC87 control system on CNC machines or woodCommander 4 on throughfeed machines)
- Fresh, attractive design, based on the new WEINMANN machine design

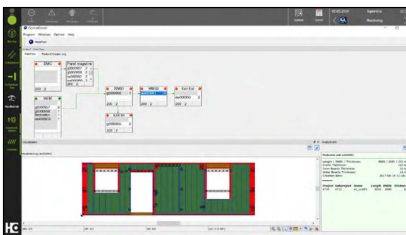

wupClient

The wupClient production line control unit enables communication between individual machines and a production system. The entire flow of data from CAD up to execution by the relevant machine is displayed. The production line control unit (wupServer or external control systems) used in combination with the wupClient installed on the machine provides central control of the production flow. The machines receive the right information at the right time, the elements are produced in the desired order and the outlay for logistics is reduced.

Tool database

The software is used to maintain all tool data, including dimensions, collision dimensions and permitted speeds. A graphical user interface supports the user during data entry, allowing the machine software to select the right tools for the task at hand.

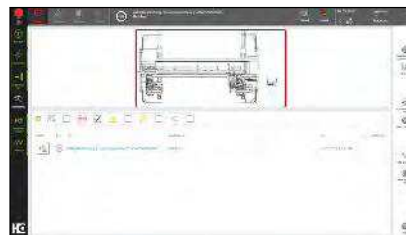

woodScout

The woodScout diagnostic system displays warnings and errors for diagnostic purposes. The program enables systematic troubleshooting, which increases machine availability.

You can also add your own comments to the expert information displayed. The integrated machine documentation automatically opens at the correct location for the fault description in question. The program provides information in a simple and user-friendly way, enabling you to resolve faults quickly and independently.

- Displays faults and warnings
- Quick and easy diagnosis and troubleshooting
- Reduces machine downtime

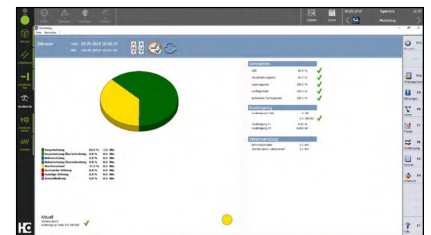

MMR Basic, Professional & Office

The MMR software module (Machine Monitoring & Reporting) records all production and machine data. The software logs a wide range of important data, including the number of workpieces produced and the run time of the machine. The usage-dependent maintenance instructions ensure that the right maintenance is carried out at the right time.

- Manual justification option when machine is in standby mode
- Display of maintenance information for the necessary service work
- Evaluation of key figures as daily and shift values
- Graphic evaluation of the machine statuses
- Fault analysis of error messages on the machine
- Option to connect to MMR Office to analyze data centrally in the office

Easy to get. And easy to use.

tapio is the open wood industry ecosystem

This means that everyone involved in the wood industry can participate.
Because together with our business partners, we develop digital solutions for everyone.

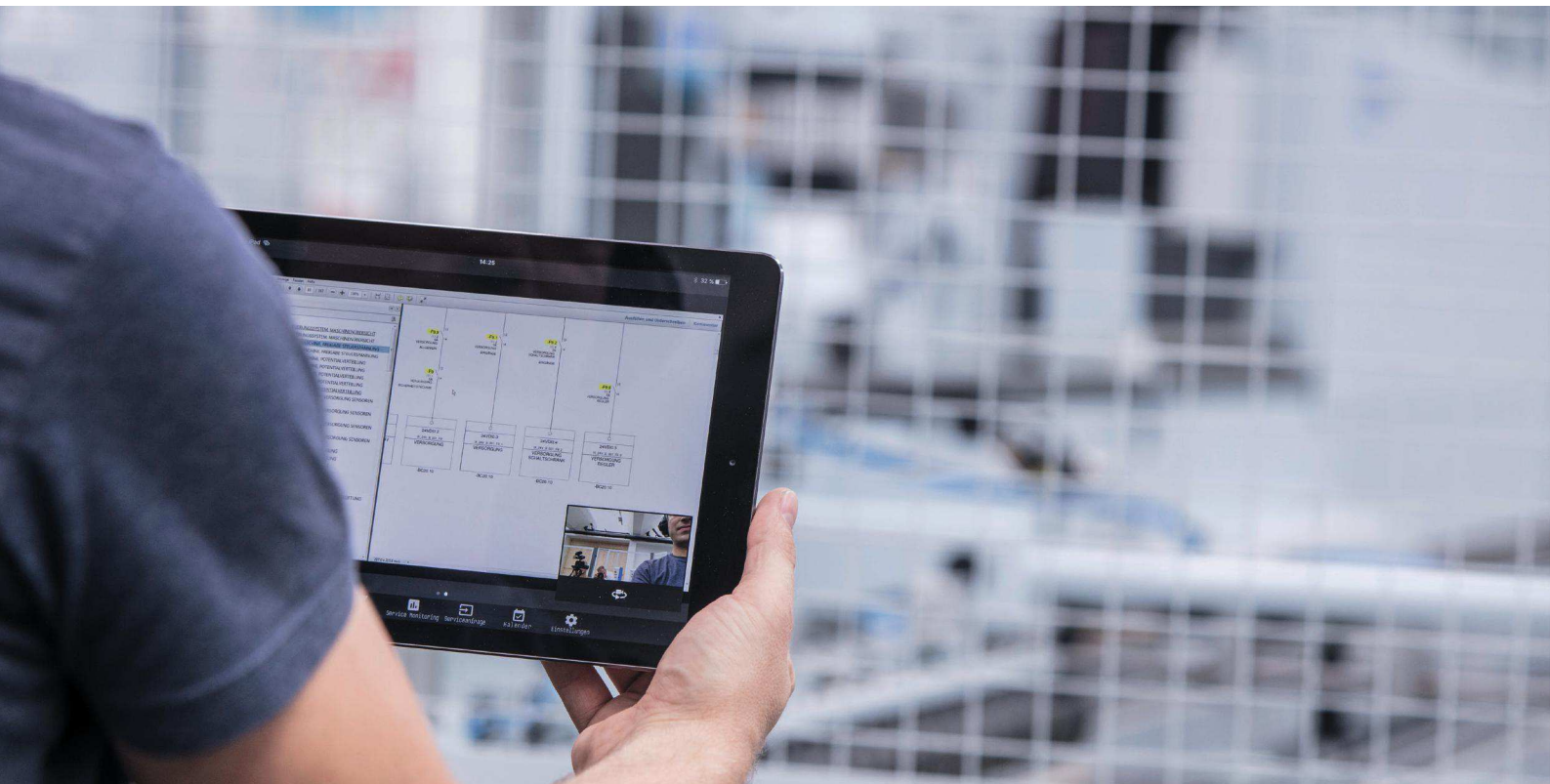

Just have a try:

Free use of the MachineBoard app! Just register under tapio and “connect” the machine www.tapio.one. The complimentary usage is limited in time.

Apps that make working life easier.

tapio
Partner

DataSave

- Protects machine and configuration expertise
- Faster service for machine breakdowns
- Saves time when restarting production
- Saves on maintenance costs
- Automatic backups of several machines

ServiceBoard

- Create service cases quickly and easily and send them to the correct service partner
- Live video diagnostics to solve service cases with image support
- Video reduces the language and distance barriers
- Also works without a machine connection to tapio (and is therefore ideal for older machines)

MachineBoard

- Push notifications
- Machine data and status can be viewed from anywhere in real time
- Lists of errors, warnings, maintenance tasks and actions
- Displays the remaining time until the next intervention by the machine operator



Free demo for all tapio apps, no registration required. Simply download and test.

Currently available in the EU and Switzerland.

(Due to the fast pace of the IT-landscape, the compatibility to the tapio platform is warranted for five years).

HC LIFE CYCLE SERVICES

Optimal service and individual consultations are included in the purchase of our machines. We support you with service innovations and products which are especially tailored to your requirements. With short response times and fast

customer solutions we guarantee consistently high availability and economical production – over the entire life cycle of your machine.



REMOTE SERVICE

- Hotline support via remote diagnosis by our trained experts regarding control, mechanics and process technology. Thus, more than 90% less on-site service required and consequently a faster solution for you!
- The ServiceBoard App helps to solve tasks in a fast, simple and concrete way. This is achieved by mobile live video diagnosis, automatic sending of service requests or the online spare parts catalog eParts.



SPARE PARTS SERVICE

- High spare parts availability and fast delivery.
- Ensuring quality by predefined spare parts and wear parts kits, comprising original spare parts.
- Identify and inquire for spare parts online under www.eParts.de 24/7, or buy even faster and more comfortably in the new HOMAG Webshop eCommerce.



MODERNIZATION

- Keep your machinery up to date and increase your productivity as well as your product quality, This is how you can meet tomorrow's requirements today!
- We support you with upgrades, modernization as well as individual consultancy and developments.



DIGITAL SERVICES

- ISN (intelliServiceNet) – The new remote service solution of the future! Fast restart of production because the remote service employee has extensive access to relevant physical data.
- intelliAdvice App – provides help for self-help. The preventive solutions proposed in the new App are the combination of our experiences and existing machine data.

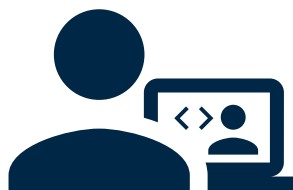

SOFTWARE

- Telephone support and consultancy through software support.
- machinery with intelligent software solutions ranging from construction to production.



FIELD SERVICE

- Increased machine availability and product quality by certified service staff.
- Regular checks through maintenance / inspection guarantee the highest quality of your products.
- We offer you the highest availability of technicians in order to reduce downtimes in case of unpredictable troubles.



TRAINING

- Thanks to training perfectly suited to your requirements, your machine operators can optimally operate and maintain the WEINMANN machines.
- The training also include customer-specific training documents with exercises proven in practice.
- Online training and webinars. Learn without traveling, meet your trainer in the digital classroom.

For you more than...

1,350

service employees worldwide

90%

less on-site service thanks to successful remote diagnosis

5,000

customer training sessions per / year

150,000

machines, all electronically documented in 28 different languages – in eParts

WEINMANN Holzbausystemtechnik GmbH

YOUR SOLUTION

info@weinmann-partner.de

www.hornmag.com/weinmann

