

SPECTACULAR SAWING!

WALLTEQ M-300 — For more houses every year.
The new multifunction bridge.







This is SPECTACULAR SAWING!

Your entry into automation: The new multifunction bridge WALLTEQ M-300. Made to move your business forward. The WALLTEQ M-300 has the ability to mill, saw (NEW!), clamp, mark and fasten, and manufactures with the highest precision. Its space requirement is minimal, its flexibility is greater, thanks to a quick tool changer and clever functions. The results are impressive. On the construction site and in your balance sheet even more so: **Expect up to 30% more productivity.**

YOUR SOLUTION

[MORE AT HOMAG.COM/WEINMANN](https://www.homag.com/weinmann)

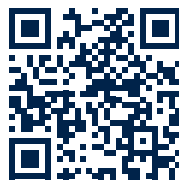

Product brochure

CONTENT

- 04 The future belongs to timber construction
- 08 Standard equipment
- 10 Equipment options
- 14 Expansion stages robot
- 16 Software
- 19 Apps
- 20 Training
- 22 Consulting package SCHULER
- 26 Life Cycle Services

Who is actually the hero here? That's right, IT'S YOU!

Why your role is more important than ever and how we want to support you.

THE FUTURE BELONGS TO TIMBER CONSTRUCTION

Housing shortages, climate change, and other challenges to our future: How can we fight back? One of the most important ways is by you, the carpenters. Every day, you help solve some of the most pressing problems in our world. Not by wielding speeches, but by getting down to work. In Germany, more than one in five buildings is now a timber structure, and the trend is rising. Throughout the world, timber is becoming more and more important as a building material. For good reasons: 40 to 80 tons of CO₂ are bound up in every single-family house made of wood - a multiple of the annual per capita emissions. In contrast, the construction of a concrete house releases almost 80 tons of CO₂. And if a wooden house is dismantled after 100 or more years, the natural material can simply be reused.



No wonder, then, that construction experts are calling for a resource turnaround instead of an energy turnaround. Carpenters can only smile about this and carry on as before. Although, of course, that's not quite true either. Their craft is also constantly evolving and has become a key discipline in the current situation. According to all forecasts, the boom in demand is set to intensify, and skilled workers are as sought-after as they are rare.

One factor that helps you to master the growing challenges is automation. It is an honor for us to be your partner with WEINMANN machines and expertise. This may be obvious, but it simply has to be said.

We are happy to provide you with ergonomic relief and thus also contribute to better prospects for older professionals. After all, every hand is needed. So that the future continues to belong to timber construction. And not the shortage of skilled workers.

By the way: In the 100 seconds or so in which you have been reading this text, 350 cubic meters of wood have grown in our forests. Working in a more "growth-focused" industry almost impossible.



TURN OF THE TIMES

Milling, sawing and much more:
The new multifunction bridge WEINMANN WALLTEQ M-300.

YOUR ENTRY INTO AUTOMATION

The WALLTEQ M-300 offers everything that carpentry businesses want:

- **Quick tool changes, whether sawing or milling, marking or fastening**
- **Minimum space requirement with maximum versatility**
- **Approx. 30% more productivity without additional personnel**



"We've gained a time savings of about 35% and increased our productivity from six houses a year to eleven houses - all with the same team."

Florian Wissel, Zimmerei Wissel, Germany

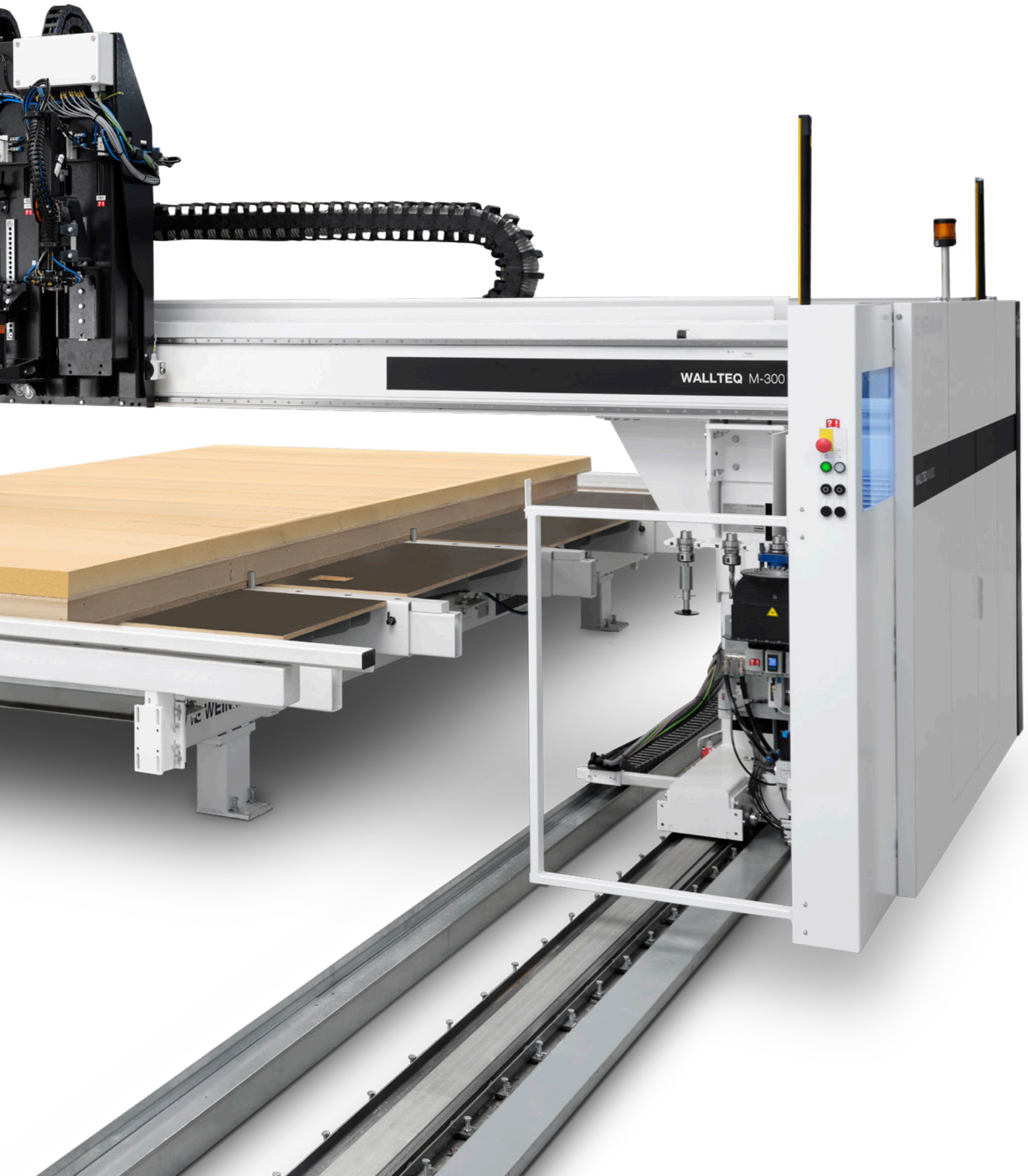

WALLTEQ M-300

The WALLTEQ M-300 is already well equipped as standard and can also be expanded selectively. In this way, you can carry out all machining work in the workshop with the highest precision and save a lot of time... and nerves later on the construction site... and nerves.

Equipped with two fastening units and, if desired, with a milling and/or sawing unit, all machining operations on wall and roof and ceiling elements are possible. The high machining speed and the relatively narrow table of the WALLTEQ M-300 pay off in terms of time and space savings.



Wide back staples

For more flexible wall constructions. Already in the standard version combined with the helpful sliding shoe, you can not only staple but also saw. And for maximum cleanliness, we have doubled the suction.



WEINMANN
WALLTEQ M-300

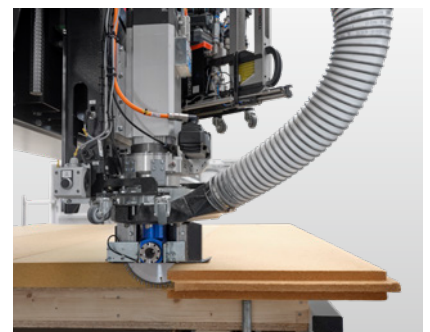

Sawing tool with HSK receptacle

In addition to the flexibility of the HSK receptacle, and the precision of the cut, the cleanliness at work is impressive here thanks to the new increased suction power of 2.2kW.

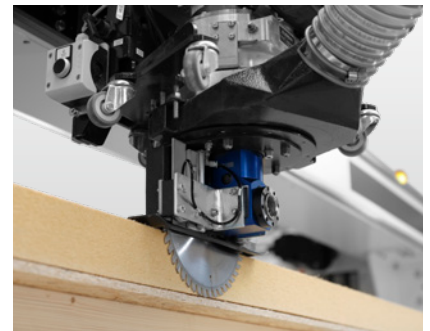

Fully automatic CNC processing

The sawing unit enables tasks to be completed much more quickly and accurately, which could otherwise only be done by hand on the construction site.

- Up to 80 mm cutting depth
- Saw guard with integrated suction technology



Compact dust extractor

Since dust is usually a nuisance, we focused on the "BAM, and gone" motto when developing this function. The compact dust extractor really gets going, especially when milling.



Fully automatic machining with milling unit

- Up to 90 mm depth
- Milling protection with integrated suction technology



Optionally expandable (options cannot be combined at will):

- Sliding shoe
- swiveling chuck for nailing devices
- Additional sawing units
- Increase of the machining width to 3.80 m

Get things done in your shop today – don't save them for the construction site.

The WALLTEQ M-300 is automation already at entry level. And all this at an excellent price-performance ratio. So many functions in so little space.

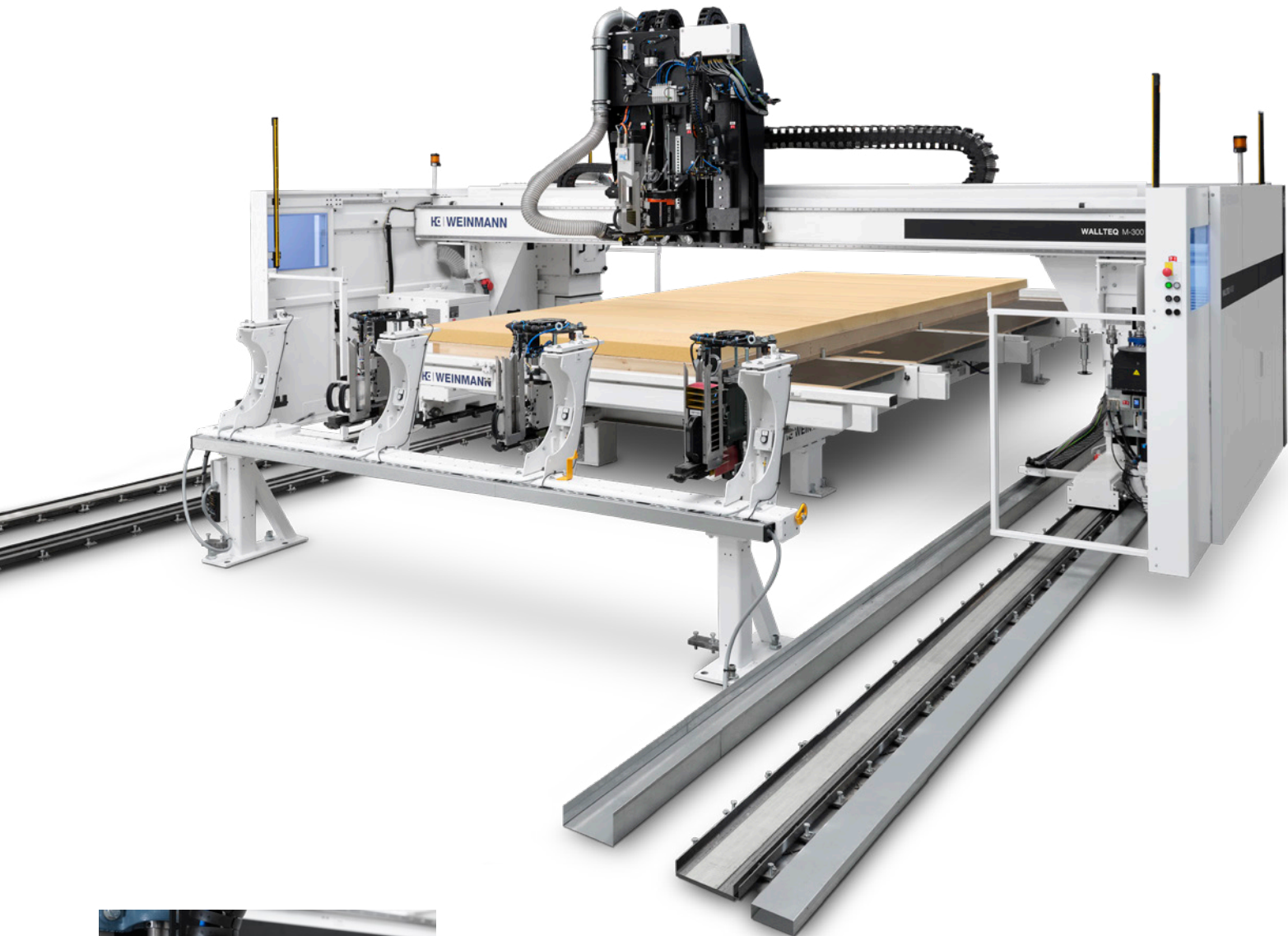

fastenerSwitch – quick-change system for up to 4 fastening units

Fast and precise change of necessary aggregates increases the flexibility to react to different fasteners and/or material types. At the same time, the changing system saves a lot of space because there is no need to select an additional bridge. A doubly attractive solution in the entry level of automation.

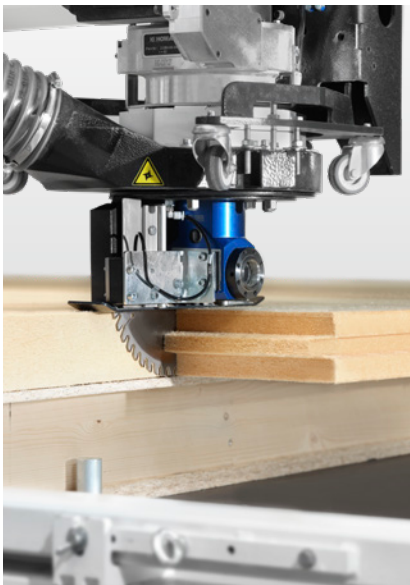

Fully automatic processing with sawing unit

- Up to 80 mm cutting depth
- Saw guard with integrated suction technology

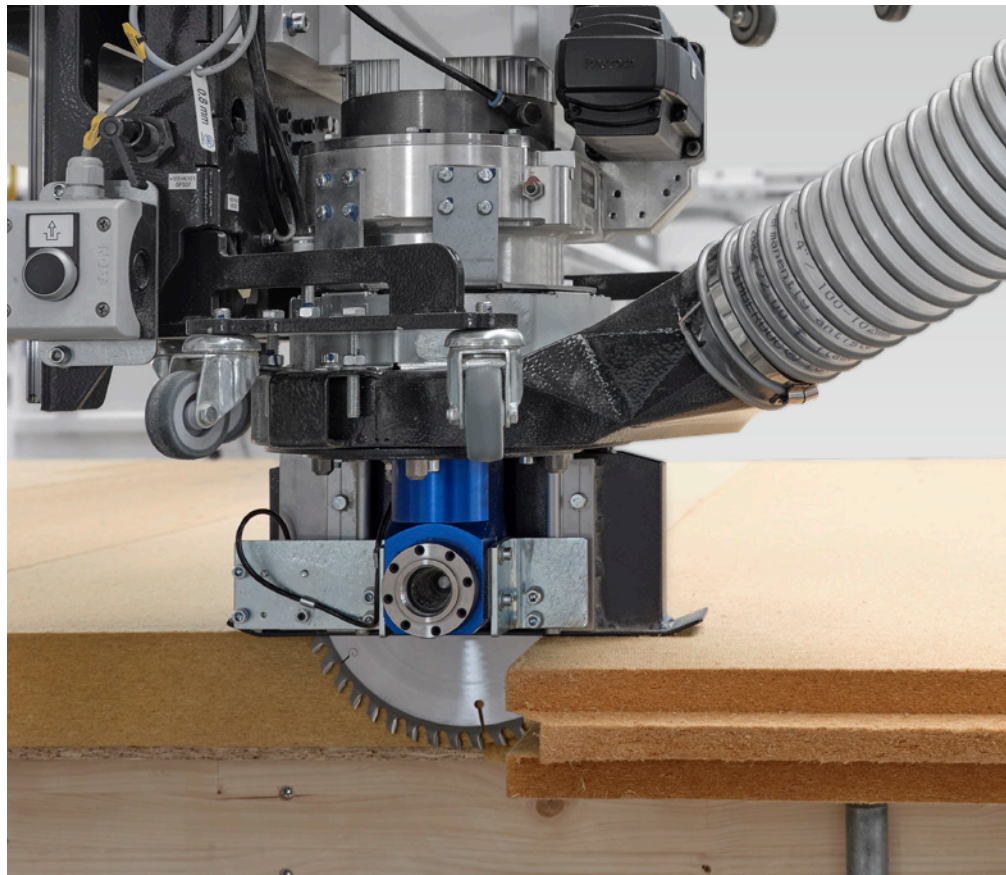

Machining wood fibre insulation boards with a large saw blade

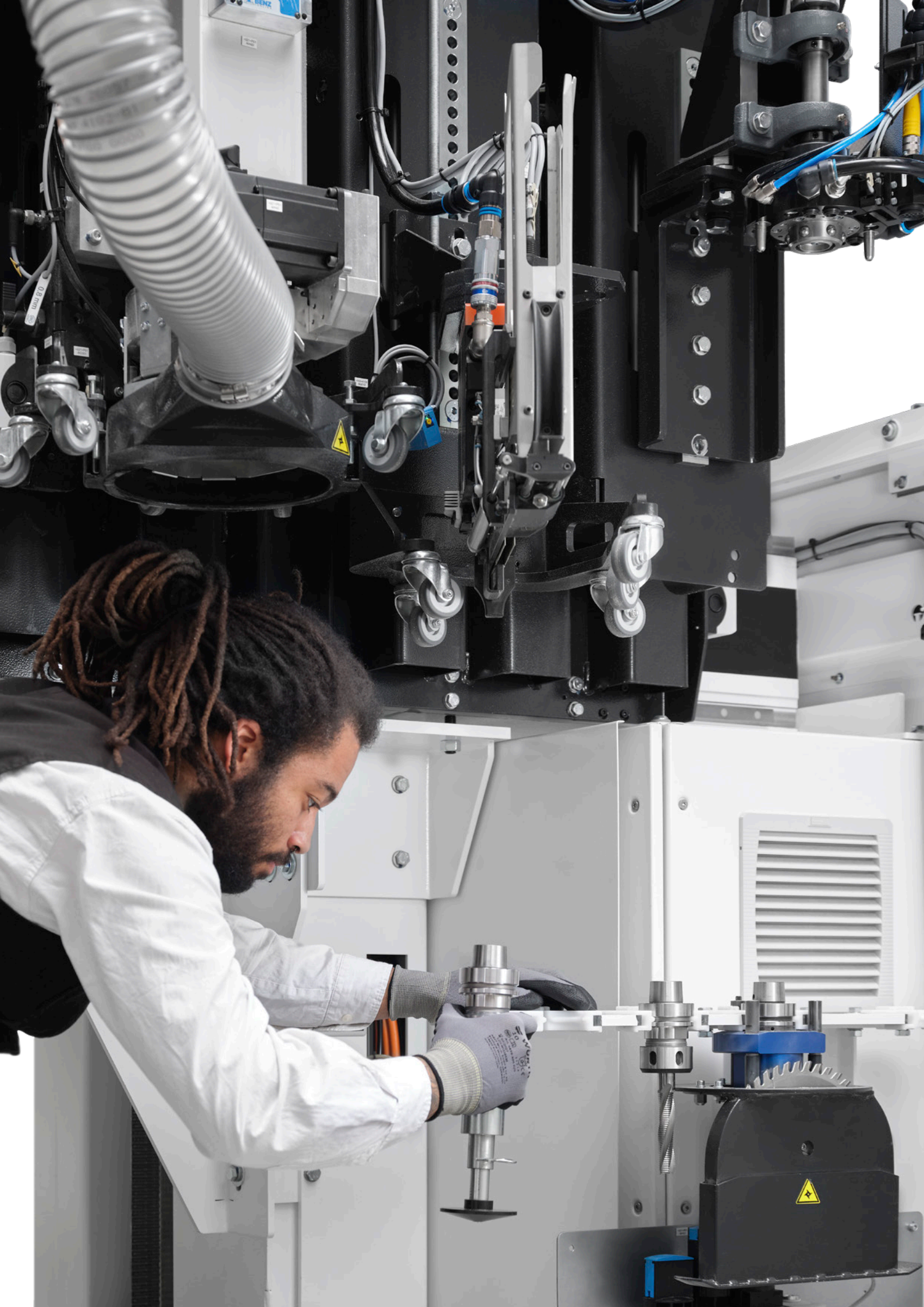

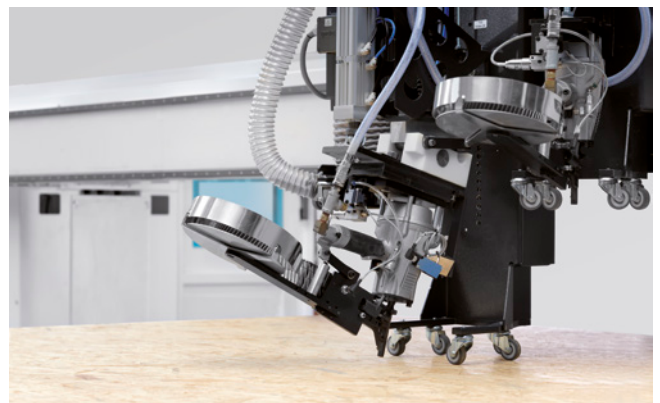
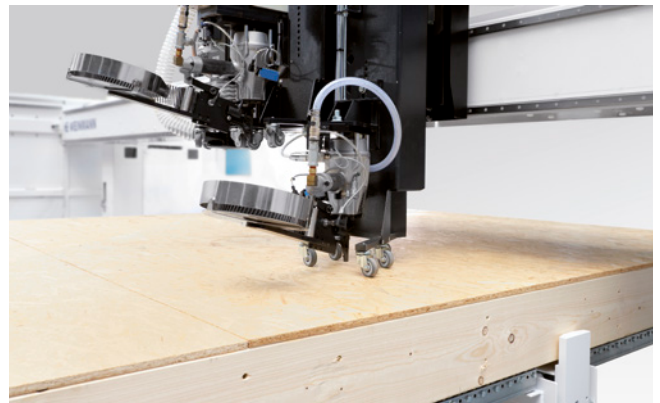
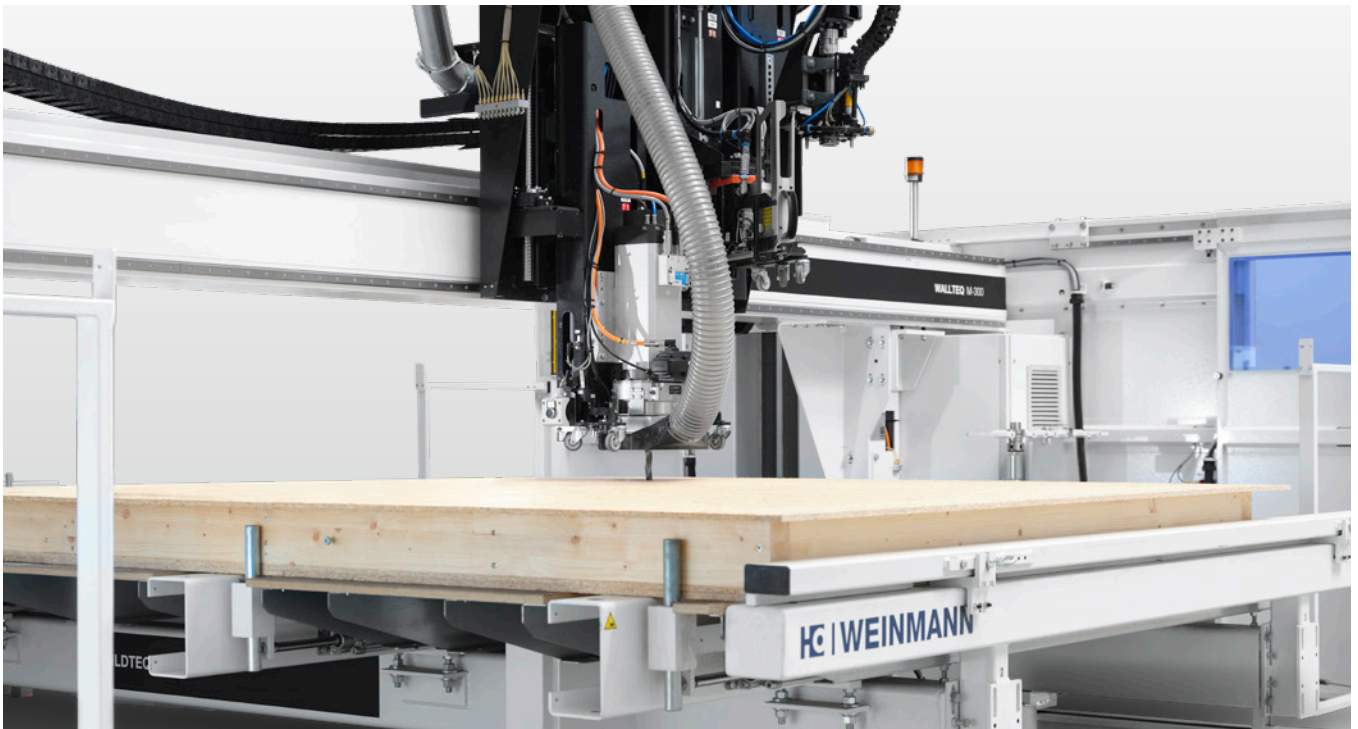

Precise milling as standard:

With the powerful cutter, any recesses such as socket holes, are a breeze.

Option: Swiveling unit for fastening aggregates

The angled insertion of fastening material is particularly in demand for narrow framing structures (2x4 market).

Next Level with Robot?

Yes, gladly if required!

Availability of almost 100 %, high repeatability and precise material handling – robots are reliable partners and automatically increase the efficiency of production in wood construction. In addition to increasing process quality, you can use your freed-up personnel elsewhere.

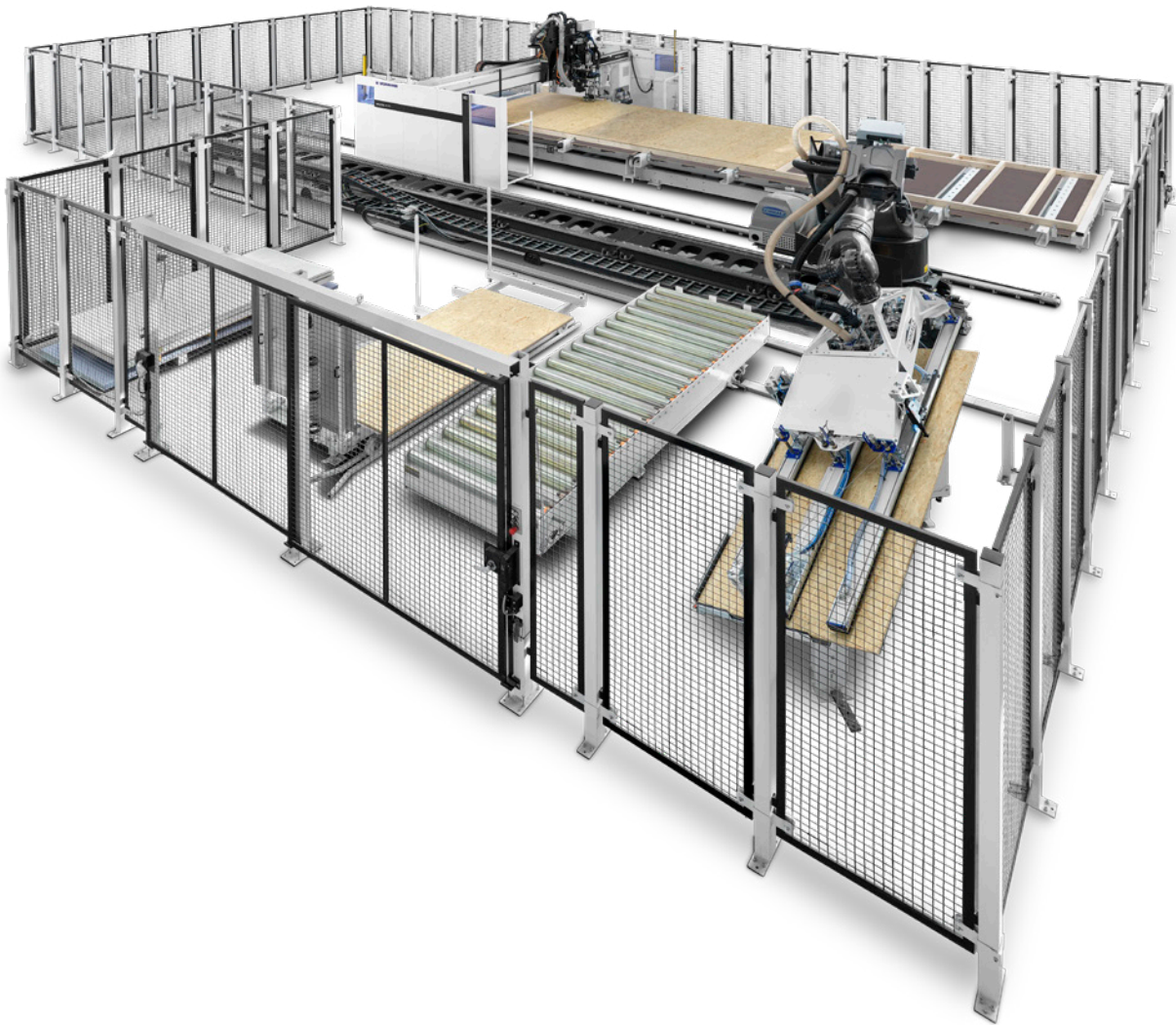

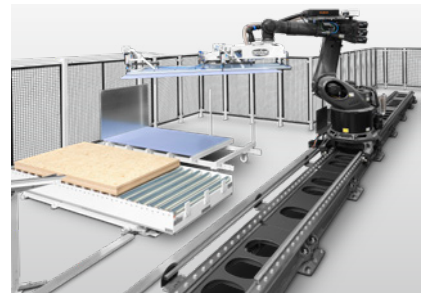
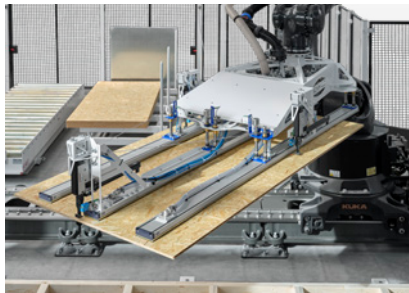
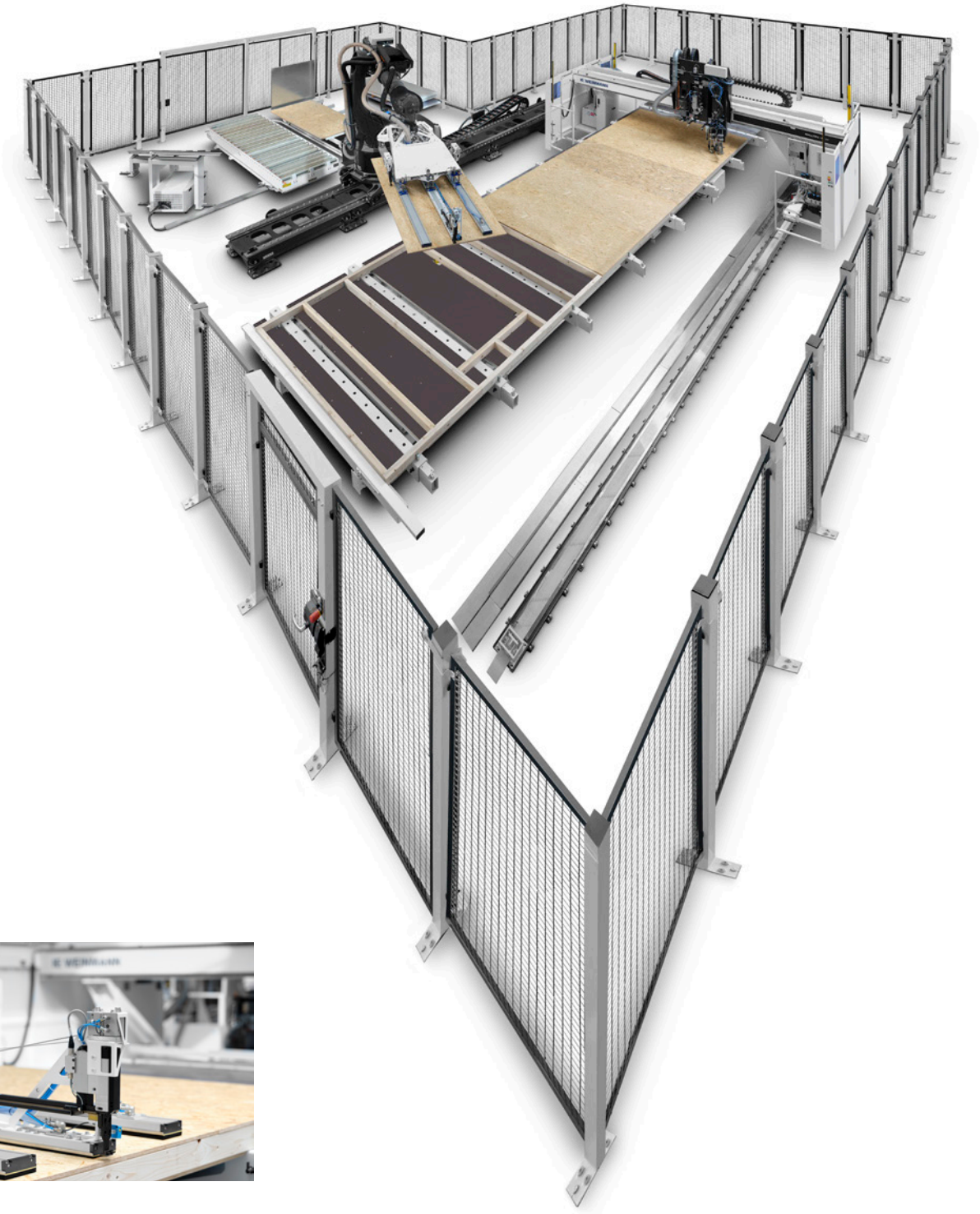

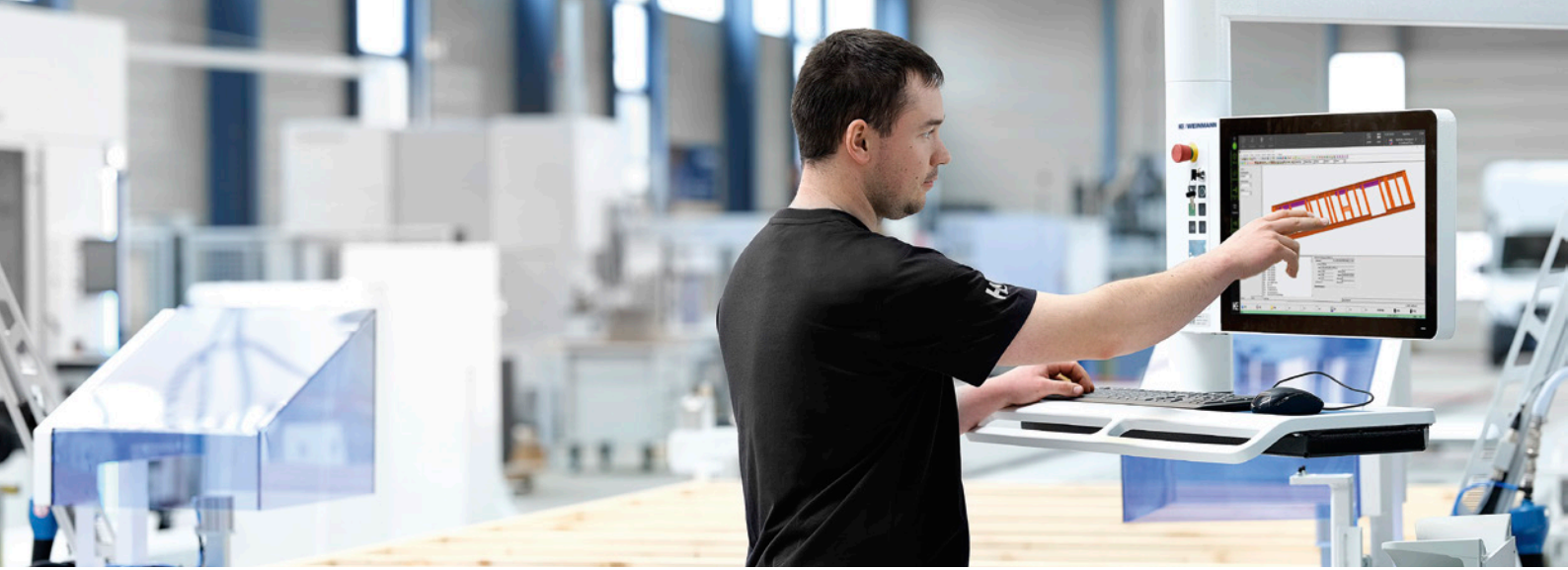

Software for the machine

wupWorks for the machine

wupWorks is the user interface for your machine's control system. The software automatically reads in, optimizes and processes the data records generated by the CAD. Thanks to the data interface, the machine is controlled independently of the CAD. In addition, the software enables you to graphically display workpieces and to control processing. You can assign machine functions, and travel paths and the use of tools are optimized.

wupViewer for the machine

With wupViewer, you can import data from the CAD program and visualize it graphically. With the clear 3D display, you can easily check the workpieces and machine processing..

wupEditor for the machine

wupEditor is used to transfer and graphically display data from the CAD program. In addition to wupViewer, not only can you import and graphically visualize the workpieces, but also edit them. This allows you to remain flexible and create and extend components directly on the machine. You can also display, adjust or delete processes.

MMR Basic and MMR Professional

With MMR you have absolute transparency: How many parts are produced on which machine? How busy are the machines and what is the proportion of waiting or malfunction times? This information can be very useful for effective operation of your production. MMR Basic is available on every machine and shows you selected key figures. The MMR Professional extension is available as an option and allows you to graphically evaluate the machine statuses and counters in the form of diagrams directly on the machine. In addition, the operator can add any possible causes of malfunction to the machine.

Software for the office



wupViewer Office

With wupViewer, you can import data from the CAD program and visualize it graphically. The software is used for checking workpieces and machine processing during work preparation. The software is available as a free download on our website.

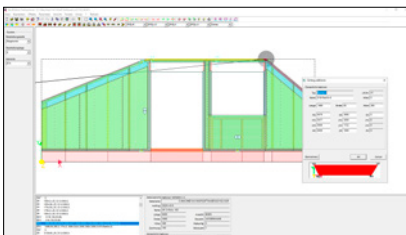

wupEditor Office

wupEditor is used to transfer and graphically display data from the CAD program. As an extension to wupViewer, not only can you import and graphically visualize the workpieces, but also edit them. wupEditor for the office can be purchased as a floating license or as a single user license.

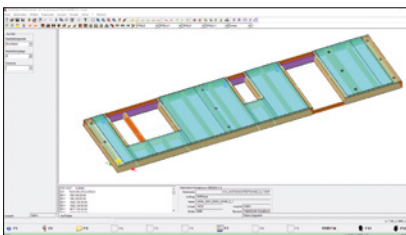

wupWorks 3 Office

With this software, you can read in and visualize WUP data records. This allows you to check whether components can be manufactured on the multifunction bridge during work preparation. wupWorks 3 can be purchased as a floating or single user license and is available for download as a trial version on our website.

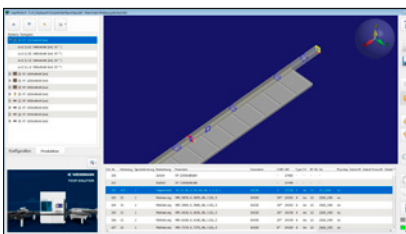

wupWorks 4 Office

With wupWorks 4, you can read in and visualize WUP or BTL data records. During work preparation, you can thereby check whether components can be manufactured on your carpentry machine and optimize unprocessed parts for orders or further production. The software can be purchased as a floating license or as a single user license and is available for download as a trial version on our website.

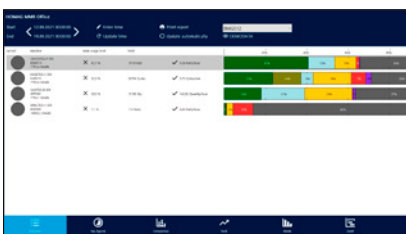

MMR Office

MMR Office copies the data from several machines to a separate database in the office. This has the advantage that the data can be viewed centrally there. The software enables you to make the machine data available for further evaluations and to connect machines from other manufacturers.



INFO

WEINMANN

Downloads and trial versions

Apps and digital assistants.

Quick and easy support in your machine environment.

Some people still use pen and paper to create their cutting patterns. But they look at their smartphone if they want to know what the weather is like – instead of looking out of the window. We asked ourselves: why not combine the best of both? Our apps and digital solutions make your everyday work easier: machines, material, tools, cutting patterns, components – you always have everything in your pocket or on your desk.

EXCERPTS FROM YOUR FEEDBACK:

- Are there simple solutions that can eliminate various obstacles in my day-to-day work (e.g. when organizing materials or sorting parts)?
- Is there a way to slowly approach using digital assistants?
- Which tools can you try out simply and easily without having to invest huge sums of money straight away?

OUR ANSWER? SMART AND POWERFUL SOLUTIONS:

- ✓ Always low investment
- ✓ Always up to date (no updates necessary)
- ✓ Always easy to use (no complex software)
- ✓ Always helpful

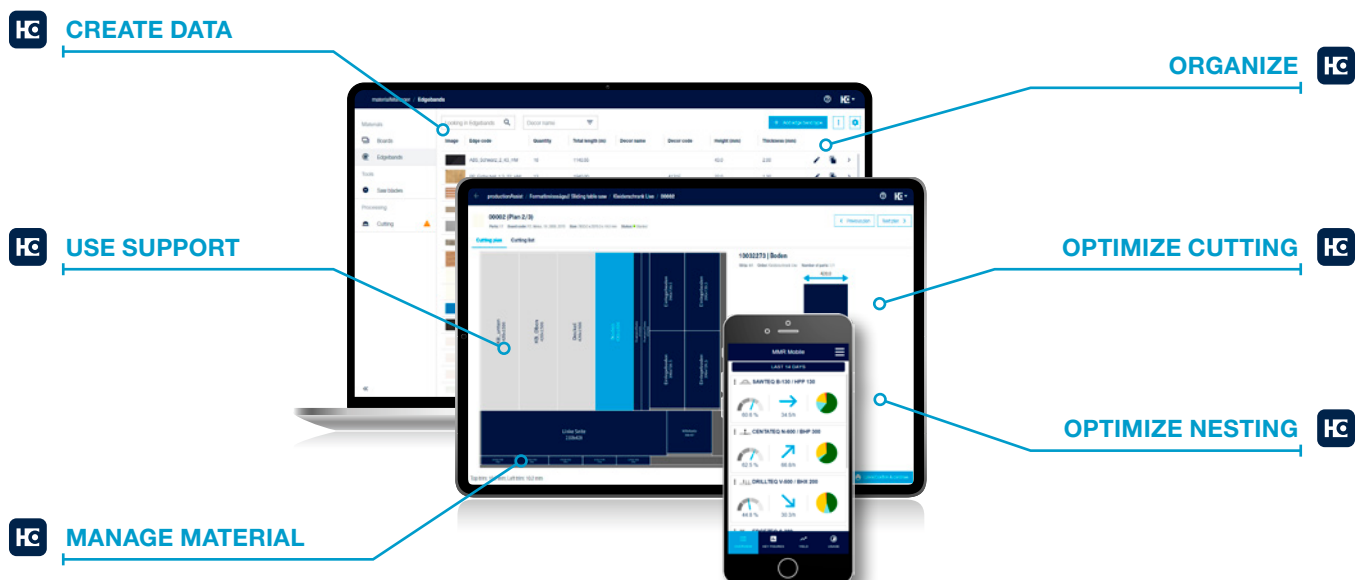



THE ADVANTAGES AT A GLANCE

- No investment, update or maintenance costs
Low starting price, no unplanned financial expense
- Licenses are independent of the user
Any number of employees can use the application without incurring additional costs
- Independent of hardware and operating system
Can be used anywhere, anytime
- Open system – import possible from almost all systems (ERP, industry software, CAD/CAM, Excel, CSV)
No obligation to use specific software systems
- Simple, smart operation
Minimal training required
- More efficient production
Jobs completed more quickly, more safely and in higher quality



More information at
digital.homag.com

The WEINMANN ACADEMY

Become a specialist (m/f/d) with us and be better than others.

Highest productivity requires technical know-how. The best way to increase your efficiency in operation and your output is through optimally trained employees. In addition to training courses for your new machine or software, we offer you continuous training and qualification. We are constantly developing our training courses and tailoring them to your individual requirements - so you are optimally prepared for current and future challenges.



PREPARATION



START OF PRODUCTION

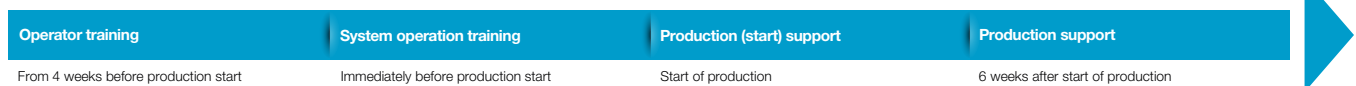

AFTERCARE/ FOLLOW-UP SERVICES



- To be presented by customer**
- CAD manufacturer offer**
- WEINMANN offer**

We are here for you!



SCHULER Consulting:

Strategies for practice

Shaping the future together

We want to shape the future of your company together with you. Set you up perfectly and lead you to success. Because only those who recognize opportunities, define the right means and also implement them consistently will be rewarded. Review the existing, question the tried and

tested, and sometimes break new ground. This is how the future works today. For this, we at WEINMANN have Schuler Consulting, probably the strongest partner based on industry know-how, at our side and directly accessible to you.



Our approach

orienting

focusing

realizing

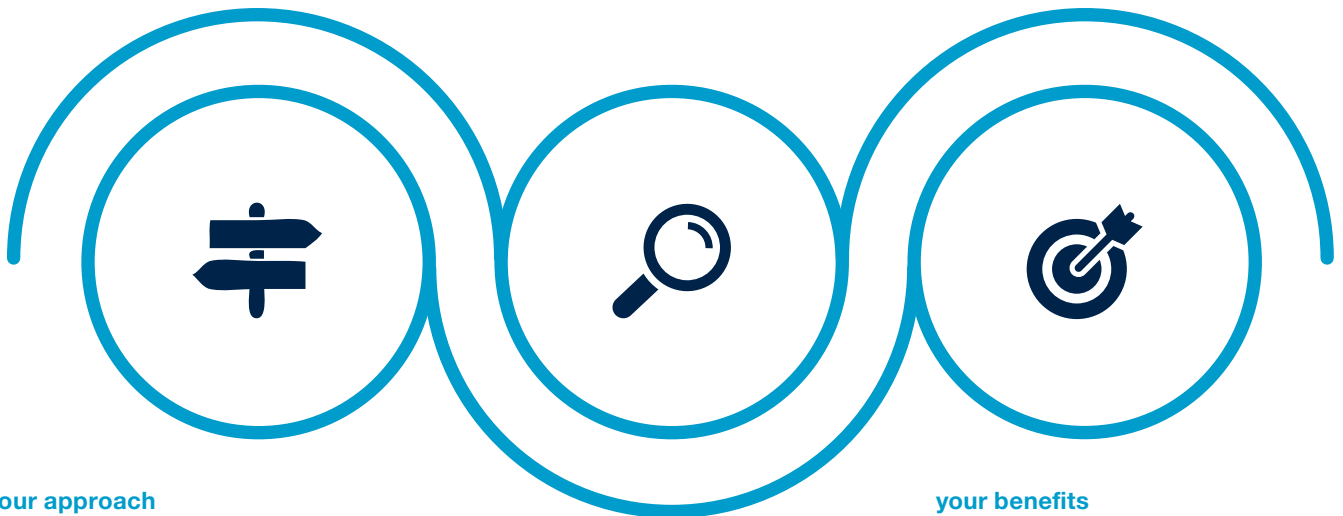

our approach

What is the state of your business today?

possible focus

Which optimisation potentials are there?

your benefits

What takes priority?



SCHULER Company ECG:

The right strategy for your future.

What we offer you? No one-size-fits-all solutions! Every company is unique, the challenges it faces are diverse. Changes in the market leave no company untouched. If you want to keep up, you have to act.

For timber construction, this means streamlining and optimizing processes, automating and digitizing. But where do you start? Feel free to contact us!

Lean Production:

Practical example: Improvements in material flow



INFO

SCHULER
Contact form



On to digital horizons!



More attractive and efficient workplaces by optimising towards lean production.

- Reduce waste (material, time, space, cost)
- Analysis and reduction of non-value added process times



Targeted automation and analysis of your processes and production

- Comprehensive analysis of your business from office to the construction site
- Development of a technology concept and recommendations for machine selection



As-is and to-be analysis as a basis for the digitalisation of your company's internal processes

- Software recommendations for work preparation
- Strategic roadmap for your digitalisation



Digitalisation in timber construction:

Getting focused and successful



We will analyse the relevant core processes in your organisation and provide you with targeted recommendations on how to break the vicious cycle of labour shortages. Together, we pave the way for meaningful digitalisation and automation. The result? You gain competitive advantages in productivity, efficiency and quality and create attractive workplaces in your company.



Recommendations for structuring and optimising your products

- Recommendations for improving and standardising your designs to increase automation and production efficiency



Support for product standardisation

- Recommendations for:
 - Construction of wall, roof and ceiling structures
 - Window and door openings
 - Component variety and dimensions



Automation and digitalisation know-how:

- Advice on the appropriate level of digitalisation and automation.
(Where do I need to digitise? Where does automation make sense?)

VALYOU

Our Mission, Your Performance.

LIFE CYCLE SERVICES

Improved performance, more efficient processes, faster help, assurance of availability and smarter working

TEAM & COVERAGE

Largest global service network in the industry with over 1,350 personnel.

INSTALLATION & COMMISSIONING

For a smooth start, we only let proven experts manage your setup.

OPERATION & CONTROL

After teaching your personnel the intuitive control system, our clever apps help to make the operator's life much easier.

MAINTENANCE & SERVICING

To keep things running, we're happy to take a preventative approach. You decide how often and how intensively you want the support to be. As we all know, prevention is better than the cure.

eSHOP & ONLINE ADVANTAGE

A few clicks and it's fixed. Receive exclusive advantages by ordering spare parts online, depending on market availability. shop.homag.com

HOTLINE & READINESS

When there's an emergency, we're here. Direct by phone, digitally via app or video, or with on-site support. We are close to you with over 90 regional service organizations worldwide. With more than 35,000 spare parts immediately available, we can deliver 85% of your orders fast.

TRAINING & EDUCATION

With classroom, live online or eLearning training, we offer flexible options to help you get knowledge. We conduct over 4,000 customer training courses every year, and we even have our own training centers in 19 countries

MODERNIZATION & IMPROVEMENT

Our modernization program is tailored to your machines and processes. We can evaluate your data and situation and advise you on the next step.

ANALYSIS & SUSTAINABILITY

On request, we analyze all your processes with proven tools and procedures (LeanSixSigma). We have a large, certified team of experts for this purpose.

FINANCING & CONSULTING

We offer you tailor-made financing concepts worldwide. With more than 60 years of experience and a close partner network of prominent banks and insurance companies to help us to find the right solution for you, we're always transparent and reliable in processing.

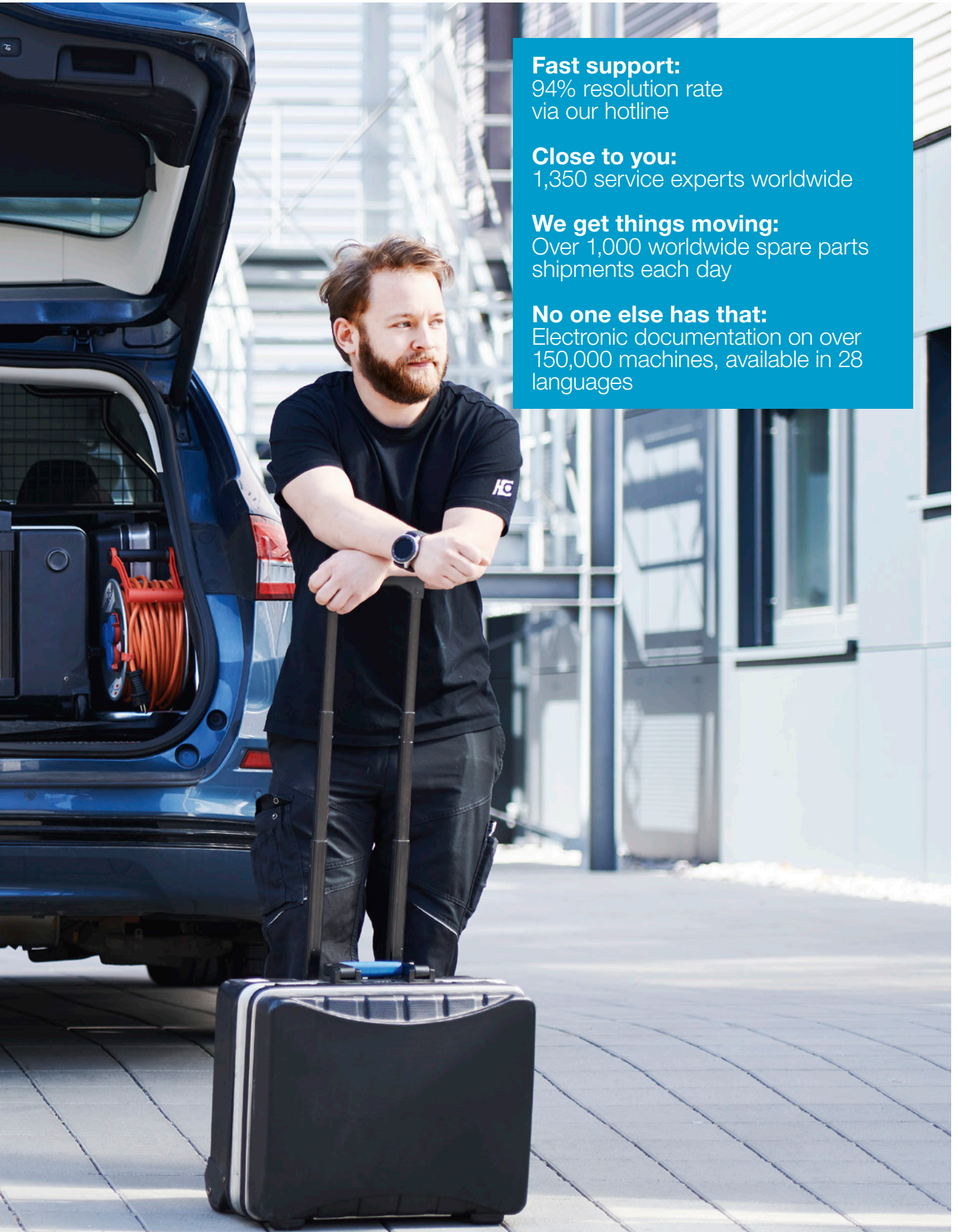

Fast support:
94% resolution rate
via our hotline

Close to you:
1,350 service experts worldwide

We get things moving:
Over 1,000 worldwide spare parts
shipments each day

No one else has that:
Electronic documentation on over
150,000 machines, available in 28
languages



HOMAG Group AG

info@homag.com
www.homag.com

YOUR SOLUTION