

STREAM

EAM

A SMART

AUTOMATIC SINGLE-SIDED
EDGEBANDING MACHINES



 **BIESSE**

50 YEARS



 **BIESSEGROUP**

EVOLVING TECHNOLOGY



THE MARKET DEMANDS

a change in manufacturing processes, enabling companies **to accept the largest possible number of orders**. This is coupled with the need to maintain high quality standards whilst offering product customisation with quick and defied delivery times, as well as responding to the needs of highly creative designers.

BIESSE MEETS

with **technological solutions** that guarantee high-quality lasting performance over long periods of time. **Stream A SMART** is the new range of automatic single-sided edgebanding machines, designed for artisan producers and small companies looking for ease of use and customised production.



STREAM A SMART

- ✓ ALL THE RELIABILITY OF AN INDUSTRIAL MACHINE
- ✓ TOP QUALITY FINISHED PRODUCT
- ✓ FULL CONFIGURABILITY FOR EVERY CUSTOMER REQUEST
- ✓ EASY-TO-USE TECHNOLOGY.

THE PRECISION OF AN INDUSTRIAL MACHINE

The sturdy structure guarantees the precision and reliability typical of production-line machines.

The **monolithic base** provides high stability and allows the machine to operate also over several work shifts whilst continuing to deliver high quality standards.



The sturdy 25 mm **columns**, fixed directly on the base, fully absorb all vibrations generated during machining.



The Belt Presser, which is standard in the Stream A Smart, allows the panel to run on the belt guaranteeing uniform pressure which is ideal even for more delicate coverings.

QUALITY EDGEBANDING

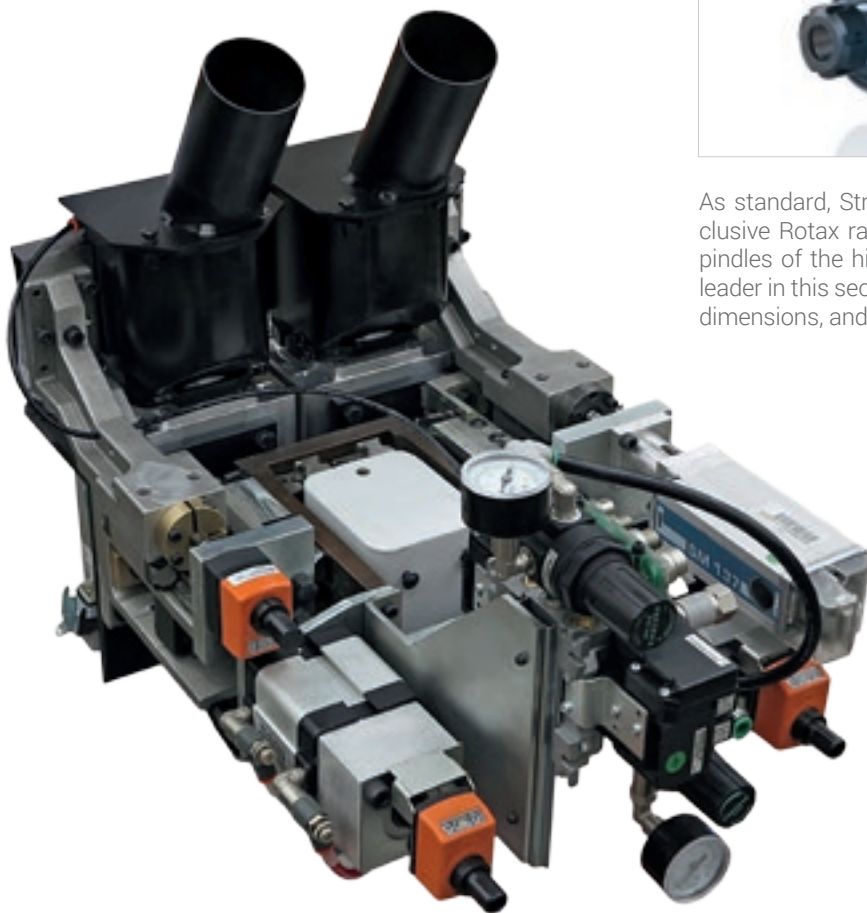

As standard, Stream uses only the electrospindles of the exclusive Rotax range on all the machines. These are electrospindles of the highest quality, designed and made by HSD (a leader in this sector); they guarantee optimum power, compact dimensions, and extremely high finishing standards.

The 2-motor **Pre-milling Unit** with automatic intervention guarantees a perfect base for glueing.

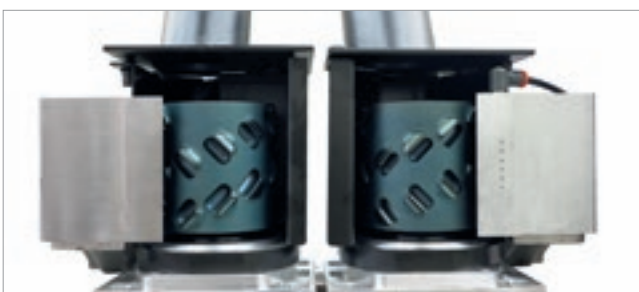

The **pre-milling copiers** allow to keep untouched the panel squaring.



The **auto-set device** for Pre-milling unit ensures the automatic centering of the tool in relation to the panel, thereby improving quality while reducing set-up times.

High-tech solutions created to guarantee high quality standards.

APPLICATION OF EDGE BANDING OF ANY SIZE

Gluing unit
for the automatic
application of edging
in rolls or strips, from
12 mm (22 mm opt).
Developed as standard
equipment for all
technologies for
maximum performance.

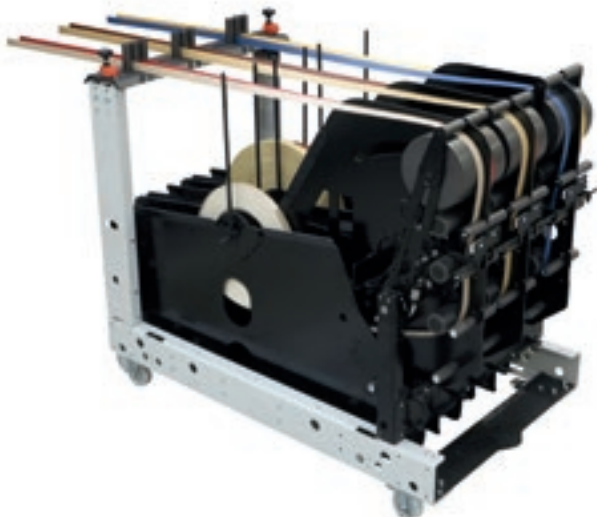
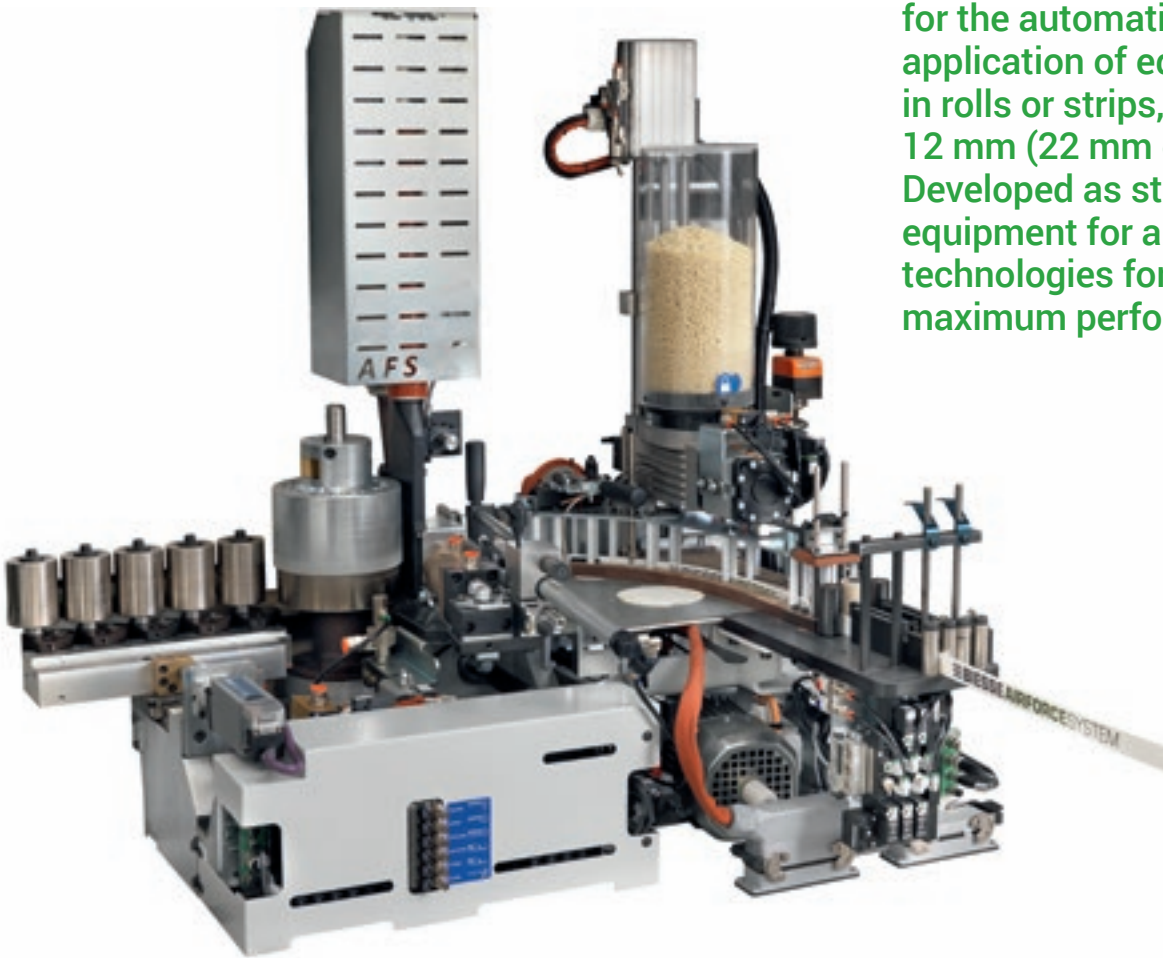

Greater flexibility and reduced tooling time thanks to the 2- or 6 -place magazine for automatic edge switchover in real time.



Glue pot

The **glue pot** is equipped with a pre-copying system to prevent direct contact between the roller and the panel, preserving the surface quality of the machined panel whilst allowing for a smooth and even application of glue, without wear to the glue pot.



New hybrid glue head for using EVA and PUR

- ✔ One single glue head that can work with both EVA and PUR in granules
- ✔ High flexibility thanks to the automatic system that drains the glue from below
- ✔ Automatic roller cleaning cycle on the basis of the panel length



Pre-melter for EVA glue

To meet all the priority machining needs:

- ✔ more glue available
- ✔ easy control of the glue level.



Pre-melter Top Melt TM10

New system for melting polyurethane glue from above.

- ✔ High flexibility of use thanks to small cartridge size.
- ✔ PUR glue on demand, according to the amount of glue used.
- ✔ Hermetically sealed system for extended glue life.



Pre-melter Top Melt TM20

New system for melting polyurethane glue from above.

- ✔ Perfect for high glue consumption.
- ✔ PUR glue on demand, according to the amount of glue used.
- ✔ Hermetically sealed system for extended glue life.

AIR FORCE SYSTEM

INVISIBLE EDGEBANDING

No joints and no glue line, in perfect harmony with the panel.

Air Force System, available on Biesse edgebanding machines, is based on the physical principle of convection. By using a compressed hot air system, the edge bonds perfectly with the panel guaranteeing resistance to water and heat and an excellent long lasting quality finish.



MAXIMUM WORKING PRECISION

Maximum cutting quality and precision thanks to the End Trimming Unit, enabling any excess to be eliminated at both ends of the panel. Two versions available according to the machining needs.

IN801

The edge trimming unit, on its THK double guide rail, guarantees optimal vibration absorption.



The IN801 unit includes, as standards:

- ✔ the dynamic suctioning system that follows the blades' every move,
- ✔ automatic blade tilting,
- ✔ copying system suitable for processing hinge holes.



Unique innovations in this machine price range to meet productivity and quality requirements of the most demanding manufacturers.



The copying and tracing system guarantees optimal finish quality also on high-gloss edges.



IT 70 S
Linear end trimmer for a perfect finish in any type of processing.

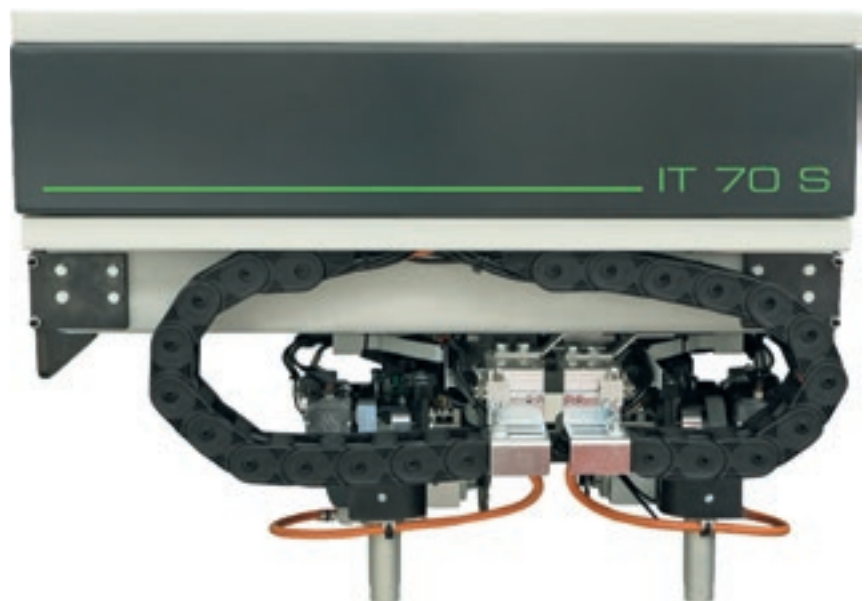

REDUCED PRODUCTION TIME



Stream A Smart offers personalized solutions that enable a reduction of set-up and machining times.

The Rough Trimmer reduces the excess edge on the top and bottom of the panel. It guarantees a perfect finish for solid wood, in one single movement (opt).

Duo System is a device for the automatic changeover between the rough-shaping and finishing functions.

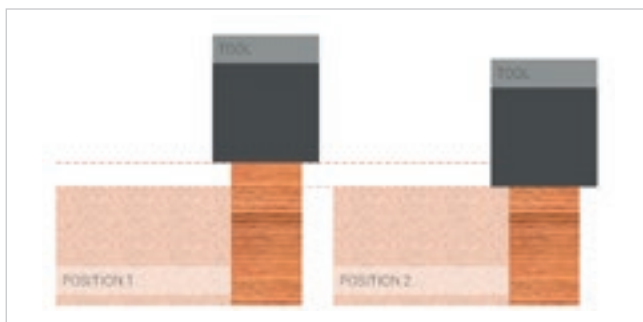



The Fine trimmer, for fine trimming of the top and bottom edges. Complete with 2 high-frequency motors and vertical/ horizontal copiers with rotating disc.



Multi-profile tools for various types of edgebanding strip.

IDENTITY

PRACTICAL DESIGN

An innovative yet simple design is the hallmark of Biesse's distinctive identity.

The transparent polycarbonate reinforced protection door is designed to guarantee maximum visibility for the operator. Fitted with 5-colour LEDs indicating machine status, it ensures that processing phases can be easily monitored.



UNIQUE TECHNOLOGY ON THE MARKET

Unique innovations in this machine price range to meet productivity and flexibility requirements of the most demanding manufacturers.

The multi-function Corner Rounding Unit forms a radius on both the front/ rear and top/bottom edges.

AR02E

Equipped with two engines for standard machining operations.

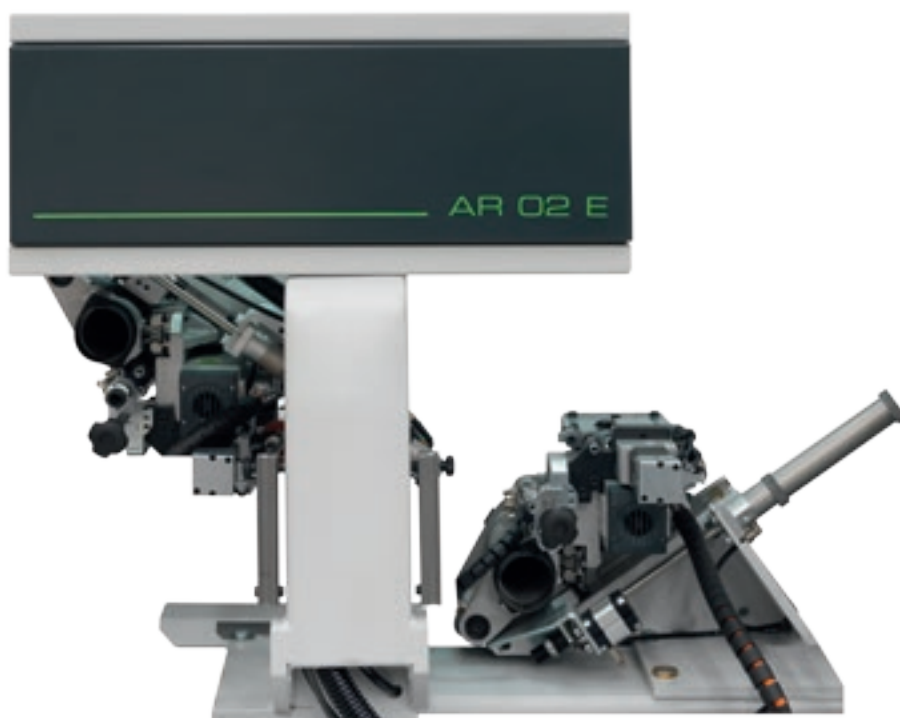

The controlled axis, fitted as standard on both version of the Corner Rounding unit, supports the management of infinite machining settings. The machine is perfectly suited to manufacturing needs.



Q-System

Patented Q-System chuck with real-time profile change.



The **Edge scraper** eliminates the imperfections resulting from previous machining operations on the top and bottom of the edge.

The axes on the edge-scraper unit enable automatic positioning in an unlimited range of positions, in accordance with the thickness of the edgebanding strip (opt.).



The **Grooving unit** can be tilted from 0 to 90°. It produces grooves and milling on the underside on the edge of the panel.

ULTIMATE RESULTS FOR FINISHED PRODUCTS

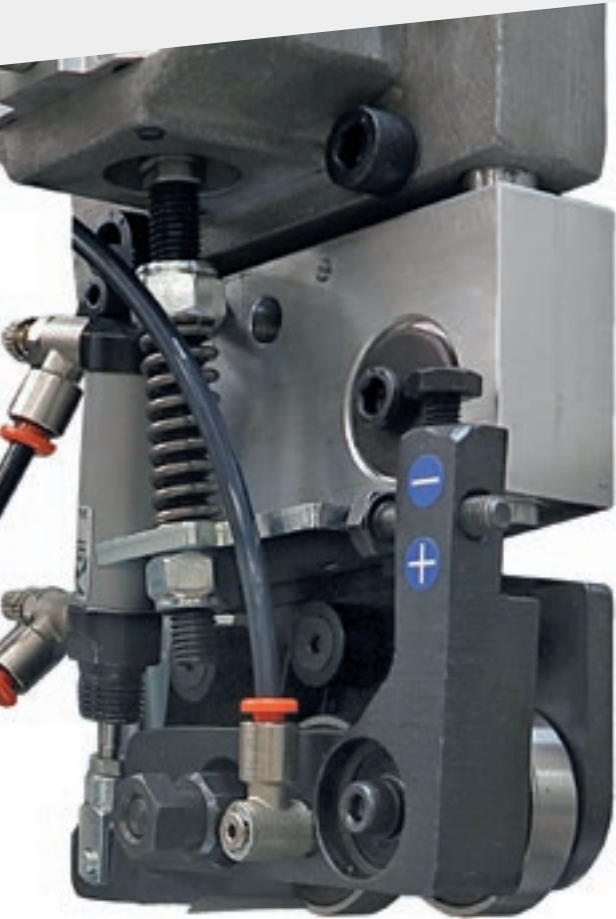

Buffing unit to clean and polish the edge and the panel.



Hot air blower for reactivating the color of the edges.



High quality results even with **high-gloss edged panels** with protective film.

TECHNOLOGY AT THE USER'S SERVICE



Advanced Statistics for monitoring productivity:

- ▶ Different types of charts available to understand and improve edgebanding machine performance
- ▶ Sub-division of the production statistics on the basis of the batch or the time gap
- ▶ Mobile app for keeping in contact with the machine status at all times.

New SMART TOUCH control 23"
Immediate, user-friendly programming thanks to the touch-screen control panel.

- ▶ Easy program management and usability.
- ▶ Rapid transition from one machining operation to the next.
- ▶ Modern, intuitive graphic interface.



TECHNICAL SPECIFICATIONS



STREAM A SMART

		L
Stream A Smart / 5.0	mm	6450
Stream A Smart / 5.5 A	mm	6950
Stream A Smart / 5.5 B	mm	6950

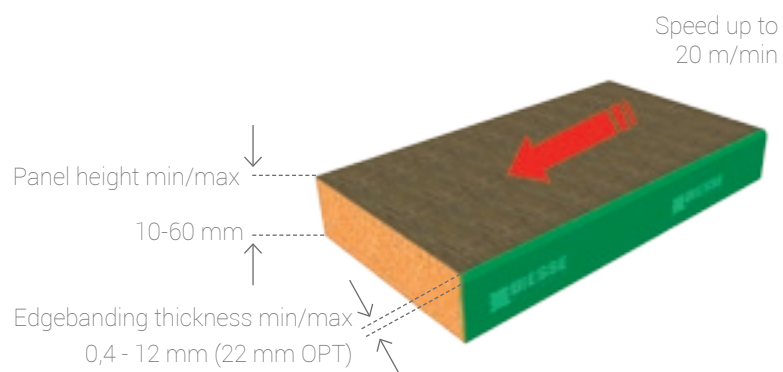

STREAM A SMART 5.0



Pre-milling unit

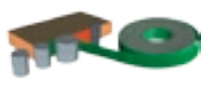

Gluing unit



End trimmer



Fine trimmer

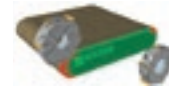

Corner rounding tool

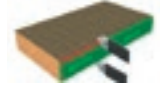

Edge scraper

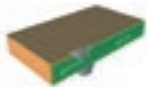

Glue scraper

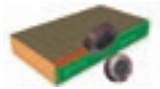

Buffing unit

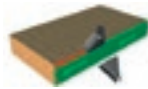

Hot air blower

STREAM A SMART 5.5 A



Pre-milling unit

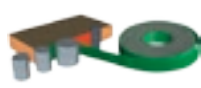

Gluing unit



End trimmer



Rough trimmer

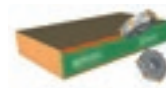

Fine trimmer



Corner rounding tool

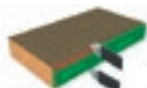

Edge scraper

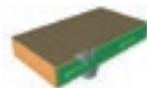

Glue scraper

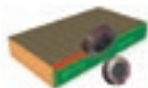

Buffing unit

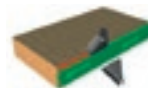

Hot air blower

STREAM A SMART 5.5 B



Pre-milling unit

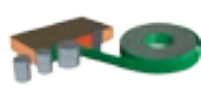

Gluing unit



End trimmer

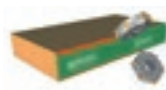

Fine trimmer



Corner rounding tool

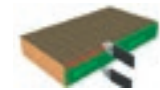

Edge scraper



Grooving unit

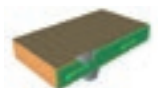

Glue scraper

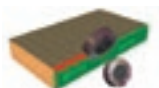

Buffing unit

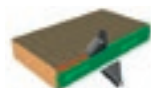

Hot air blower

The technical specifications and drawings are non-binding. Some photos may show machines equipped with optional features. Biesse Spa reserves the right to carry out modifications without prior notice.

A weighted sound pressure level (LpA) during machining for operator workstation on vane-pump machine Lpa=79dB(A) Lwa=96dB(A) A-weighted sound-pressure level (LpA) for operator workstation and sound power level (LwA) during machining on cam-pump machine Lwa=83dB(A) Lwa=100dB(A) K measurement uncertainty dB(A) 4

The measurement was carried out in compliance with UNI EN 848-3:2007, UNI EN ISO 3746: 2009 (sound power) and UNI EN ISO 11202: 2009 (sound pressure levels at workstation) during panel machining. The noise levels shown are emission levels and do not necessarily correspond to safe operation levels. Despite the fact that there is a relationship between emission and exposure levels, this may not be used in a reliable manner to establish whether further measures need to be taken. The factors determining the exposure level for the workforce include length of exposure, work environment characteristics, other sources of dust and noise, etc. i.e. the number of other adjoining machines and processes. At any rate, the above information will enable the operator to better evaluate dangers and risks.

SOPHIA

GREATER VALUE FROM MACHINES

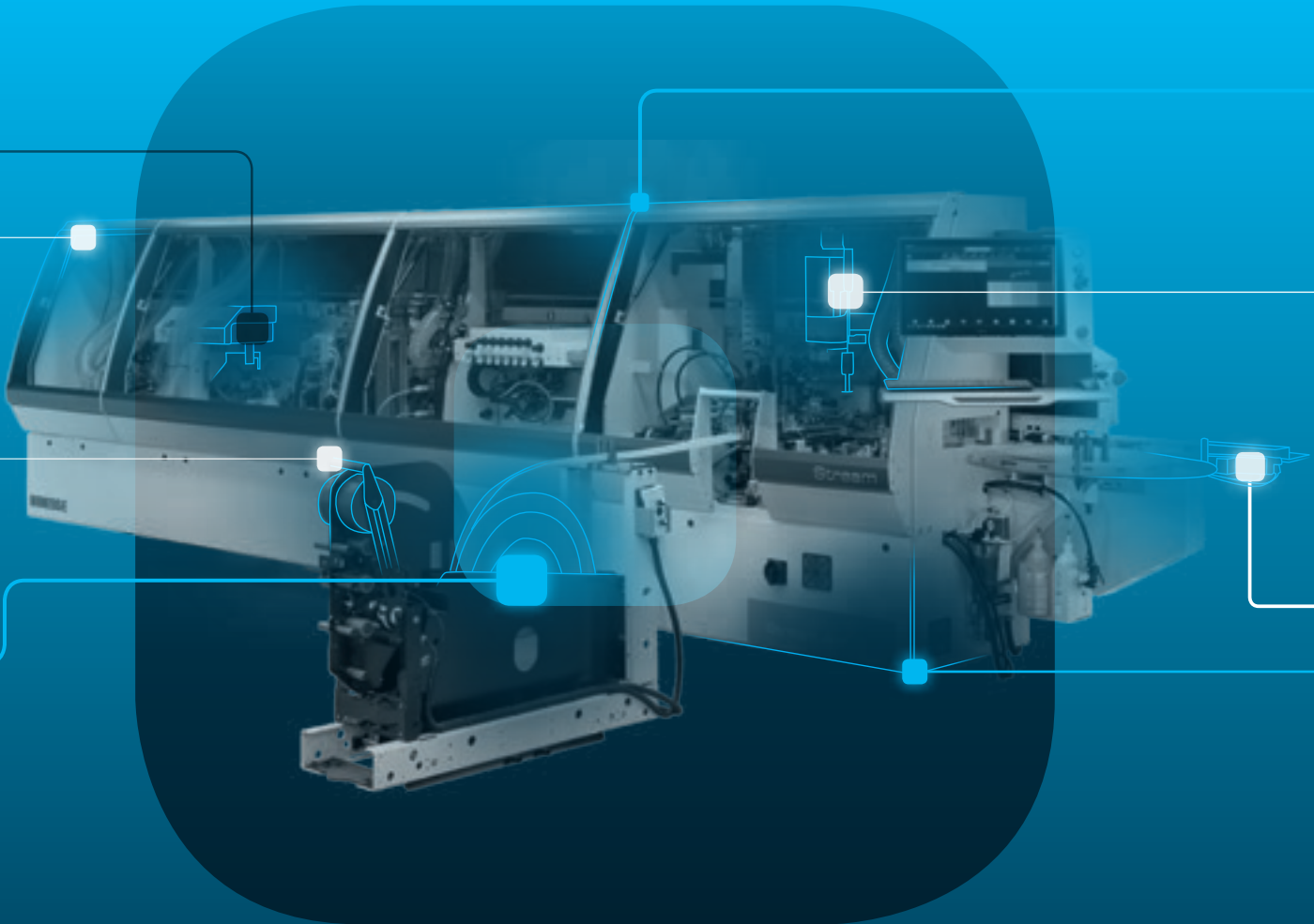

SOPHIA is the IoT platform created by Biesse in collaboration with Accenture which enables its customers to access a wide range of services to streamline and rationalise their work management processes.

It allows alerts and indicators to be sent to the customer in real time, in relation to production, the machines used and the type of process carried out. These are detailed instructions for more efficient use of the machine.

□ **10% CUT IN COSTS**

□ **50% REDUCTION
IN MACHINE DOWNTIME**

□ **10% INCREASE
IN PRODUCTIVITY**

□ **80% REDUCTION IN PROBLEM
DIAGNOSTICS TIME**

**SOPHIA TAKES THE INTERACTION BETWEEN
CUSTOMER AND SERVICE TO A HIGHER LEVEL.**

iOT
SOPHIA

IoT - SOPHIA provides a comprehensive overview of the specific machine performance features, with remote diagnostics, machine stoppage analysis and fault prevention. The service includes a continuous connection with the control centre, the option of calling for assistance from within the customer app (such calls are managed as priorities), and an inspection visit for diagnostic and performance testing within the warranty period. Through SOPHIA, the customer receives priority technical assistance.

PARTS
SOPHIA

PARTS SOPHIA is the easy new, user-friendly and personalised tool for ordering Biesse spare parts. The portal offers customers, dealers and branches the chance to navigate within a personalised account, consult the constantly updated documentation of the machines purchased, and create a spare parts purchase basket indicating the real time availability in the warehouse and the relative price list. In addition, the progress of the order can be monitored at all times.

 **BIESSE**

in collaboration with  **accenture**

SERVICE & PARTS

Direct, seamless co-ordination of service requests between Service and Parts. Support for Key Customers by dedicated Biesse personnel, either in-house and/or at the customer's site.

BIESSE SERVICE

- ✔ Machine and system installation and commissioning.
- ✔ Training centre dedicated to Biesse Field engineers, subsidiary and dealer personnel; client training directly at client's site.
- ✔ Overhaul, upgrade, repair and maintenance.
- ✔ Remote troubleshooting and diagnostics.
- ✔ Software upgrade.

500

Biesse Field engineers in Italy and worldwide.

50

Biesse engineers manning a Teleservice Centre.

550

certified Dealer engineers.

120

training courses in a variety of languages every year.

The Biesse Group promotes, nurtures and develops close and constructive relationships with customers in order to better understand their needs and improve its products and after-sales service through two dedicated areas: Biesse Service and Biesse Parts. With its global network and highly specialized team, it offers technical service and machine/component spares anywhere in the world on-site and 24/7 on-line.

BIESSE PARTS

- ✔ Original Biesse spares and spare kits customized for different machine models.
- ✔ Spare part identification support.
- ✔ Offices of DHL, UPS and GLS logistics partners located within the Biesse spare part warehouse, with multiple daily pick-ups.
- ✔ Order fulfillment time optimized thanks to a global distribution network with de-localized, automated warehouses.

92%
of downtime machine orders fulfilled
within 24 hours.

96%
of orders delivered in full on time.

100
spare part staff in Italy and worldwide.

500
orders processed every day.

MADE WITH BIESSE

BIESSE TECHNOLOGY ACCOMPANIES THE GROWTH OF STECHERT

"On these chairs sits the world" is the motto of the Stechert Group that can effectively be taken literally. What began 60 years ago as a small manufacturing company for pram mouldings, furniture doors and door locks is today one of the largest international suppliers of contract and office chairs, as well as tubular steel furniture. Moreover, since 2011 the company has a partnership with WRK GmbH, an international specialist in podiums, conference room and grandstand seating, associated with Stechert via the joint commercial company STW. For Stechert management, however, the excellent results obtained are no excuse for resting on their laurels. On the contrary, the company is investing heavily in the Trautskirchen site to make its production even more efficient and profitable. In the search for a new machinery partner, the company's management chose the Italian manufacturer Biesse. "For the project we chose machines that already had certain options and were predisposed for automation", said Roland Palm, Biesse Area Manager. An efficient production cycle was created

in which workers are able to perform at their best after only a short training period.

At the start of the production line is the panel saw "WNT 710" with one cutting line. "Because", explained skilled cabinet maker Martin Rauscher, "we want to be able to work panels of up to 5.90 metres in order to reduce waste as much as possible." Normal rectangular panels for tables or wall panels are taken directly to the "Stream" edgebander with "Air-ForceSystem" technology. The Biesse edgebander has a group that activates the laminated edging material no longer via a laser beam but using hot air to obtain the so-called "zero gap". "The quality is just as good as the laser system, if not even better: with a connection power of 7.5 kW, the cost per square metre is much lower", underlined the Biesse Area Manager.

We want to be ready for when we mould the frame ourselves and we must therefore calibrate the panels" said Martin Rauscher, "The same is true of course for solid wood and multiplex panels, which require grinding before being

painted in an external company. For both types of work a Biesse "S1" sander is used. In order to meet the needs of the future, in the Trautskirchen plant there are also two Biesse numerically controlled machining centres: a "Rover C 965 Edge" and a "Rover A 1332 R", which are perfectly complementary.

The Stechert Group also intends to strengthen sales of innovative solutions for interior fittings, with complete systems for walls, ceilings, floors and mezzanines. For panel sectioning, the Group has purchased a "Sektor 470". For other geometry, groove and spring machining as well as boring and surface milling, there are two Biesse machining centres, an "Arrow" for nesting applications, a "Rover B 440" and more recently a 5-axis machine, the "Rover C 940 R" machining centre in order to be able to produce, in particular, wall and ceiling panels machined in 3 dimensions.

Source: HK 2/2014

LIVE THE EXPERIENCE

BIESSEGROUP.COM

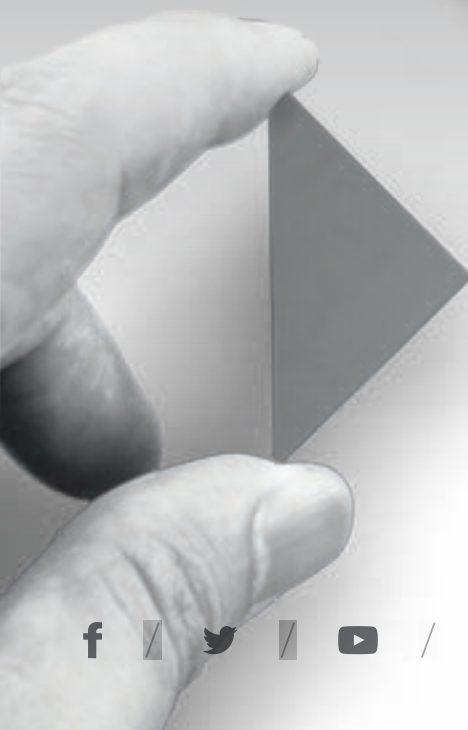

Interconnected technologies and advanced services that maximise efficiency and productivity, generating new skills to serve better our customer.

LIVE THE BIESSE GROUP EXPERIENCE AT OUR CAMPUSES ACROSS THE WORLD.



