

STREAM EAM B

AUTOMATIC SINGLE-SIDED
EDGEBANDING MACHINES

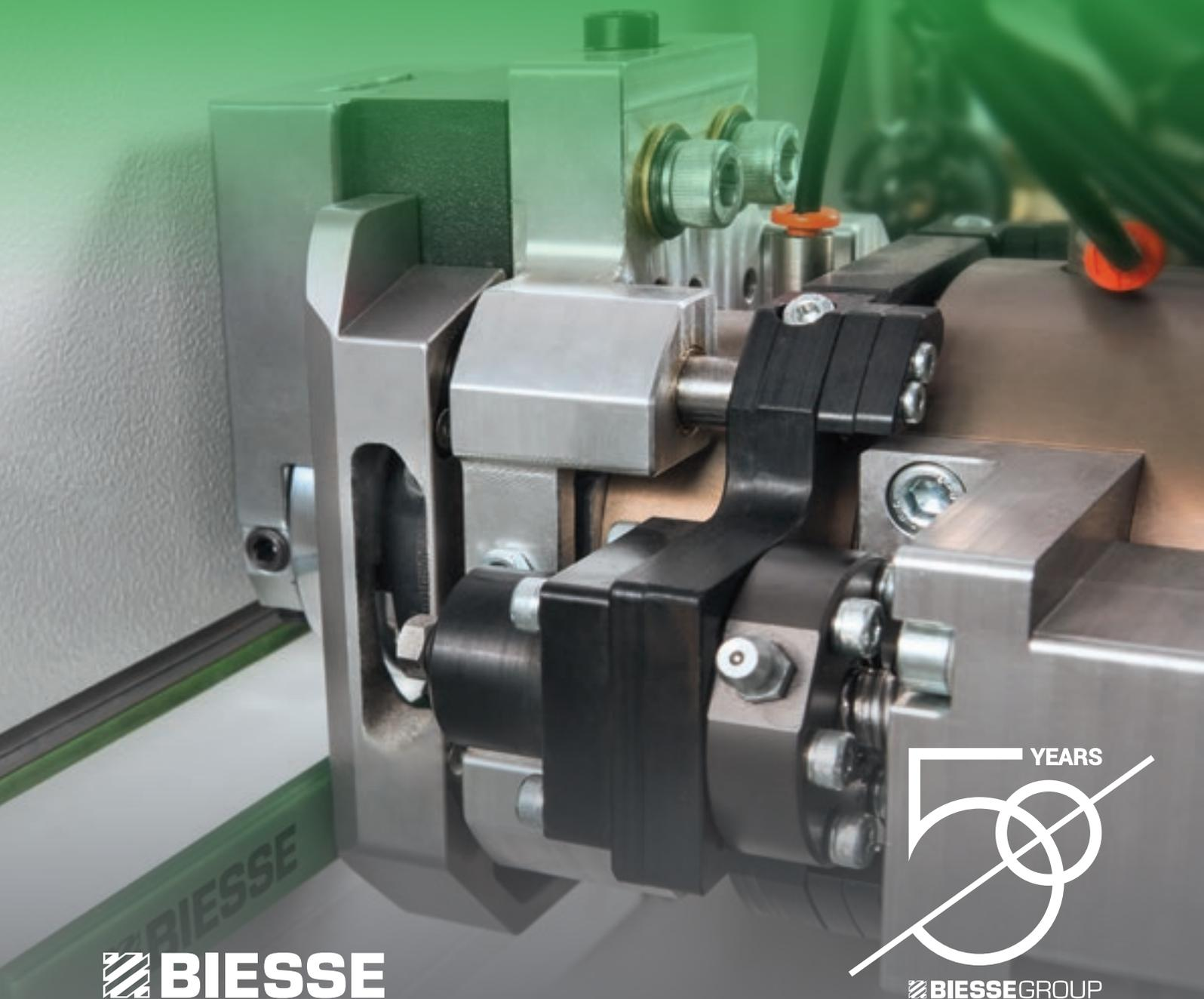

 **BIESSE**

50 YEARS

 **BIESSEGROUP**

PERFECT EDGEBANDING



THE MARKET DEMANDS

a change in manufacturing processes that will enable companies to **accept the largest possible number of orders**. This is coupled with the need to maintain high quality standards whilst offering **product customisation** with quick and defined delivery times, as well as responding to the needs of the most highly automated enterprises.

BIESSE RESPONDS

with **technological solutions** that guarantee high quality lasting performance for long periods of time. **Stream B** is a single sided edgebander that meets the needs of large companies for high productivity. It can cover three work shifts, 7 days a week, and has an endless number of possibilities for product customisation based on production requirements.



STREAM B

- ✔ RELIABLE TECHNOLOGY
- ✔ PERFECT INTEGRATION IN COMPANY WORK-FLOWS
- ✔ OPTIMAL EDGE GRIP
- ✔ MACHINING PRECISION
- ✔ ATTENTION TO DETAIL

CAN BE CONFIGURED FOR ALL TYPES OF MACHINING

Stream B can be configured to suit customers with an endless number of possibilities.

Preparation of the panel



Pre-Milling Unit



Gluing of edgelanding strip

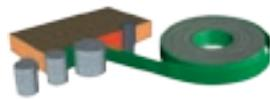

Gluing Unit



Edgelanding strip machining operations



End Trimmer Unit

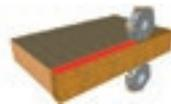

Rough Trimmer Unit

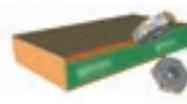

Fine Trimmer Unit



Corner Rounding Unit



Panel machining operations



Grooving Unit



Edgelanding strip finishing



Edge Scraper Unit

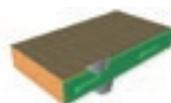

Glue Scraper Unit



Buffing Unit

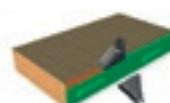

Hot Air Blower



Sanding Unit



RELIABLE TECHNOLOGY

The structure of the machine is extremely robust and rigid, sized with cutting edge calculation and design tools.



Biesse fits **ROTAX electrospindles** as standard on all its machines which are **built exclusively for Biesse by HSD**, a leading international company in the sector, and guarantee power, a compact size and extremely high finishing standards.



The **Monolithic Base** provides high stability and allows the machine to operate 24 hours a day, 7 days a week whilst continuing to deliver high quality standards.

The **Belt Presser**, which is standard in the Stream B, allows the panel to run on the belt guaranteeing uniform pressure which is ideal even for more delicate coverings.



Stream B can also be used to customise the machine's structure and guarantee maximum productivity with a series of options that increase the machine's performance.

The **First Run Wheels** perfectly align the panel on the length-wise run through constant pressure of the 3 rubber wheels.

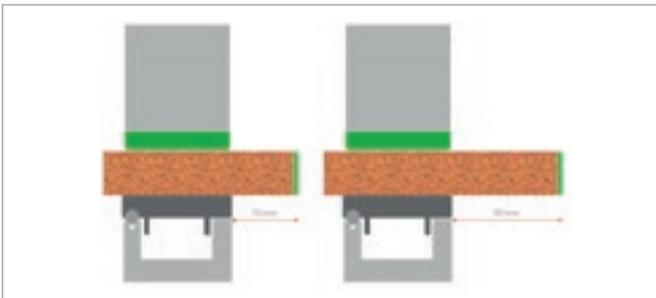
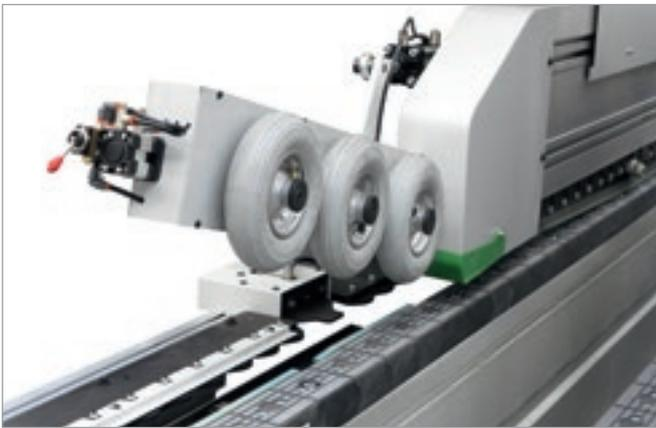

Industrial conveyor chain.



The **Movable Tables** can be used for machining which is not possible on other machines with fixed machining lines. One of the most widely used applications is the creation of channels that are more than 35 mm deep.



The **Square infeed system** is a device that guarantees that long, narrow panels are perfectly inserted into the machine for transversal machining.



PERFECT INTEGRATION INTO PRODUCTION FLOWS

Biesse can provide bespoke solutions which are tailored to meet your specific productivity, automation and space requirements.

The **Foster infeed device** is an automatic feeder that allows panels of any size to be correctly inserted into the machine on the crosswise run.



The **Parallelogram Piece Support** is an extended side support that can be used to machine large panels.

DESIGN OF INTEGRATED LINES OVER 100 METRES LONG



BiesseSystems provides a full project consultancy and management service to companies who wish to implement integrated technology solutions for their manufacturing processes.

In addition, a team of sector experts, who can understand and anticipate company needs, are always on hand to work with the customer from inception through to system installation and commissioning.

OVER 1000 SYSTEMS SOLD WORLDWIDE.

ECO-FRIENDLY EDGEBANDING



**STREAM B HAS A GREEN ENERGY SAVING
PACKAGE WHICH OPTIMISES SUCTION
AND ELECTRICITY CONSUMPTION.**

PERFECT GLUING SURFACE



The **RT20 2-motor Pre-milling Unit** with automatic intervention guarantees a perfect base for gluing. New optimisation of the suction system guarantees optimum cleaning.

The **RT30 2-motor Pre-milling Unit** with automatic intervention guarantees a perfect base for gluing. With its dual copying system, it can machine the panel profile without losing the squaring.



OPTIMAL EDGE ADHESION

Technological solutions created to guarantee high quality standards.

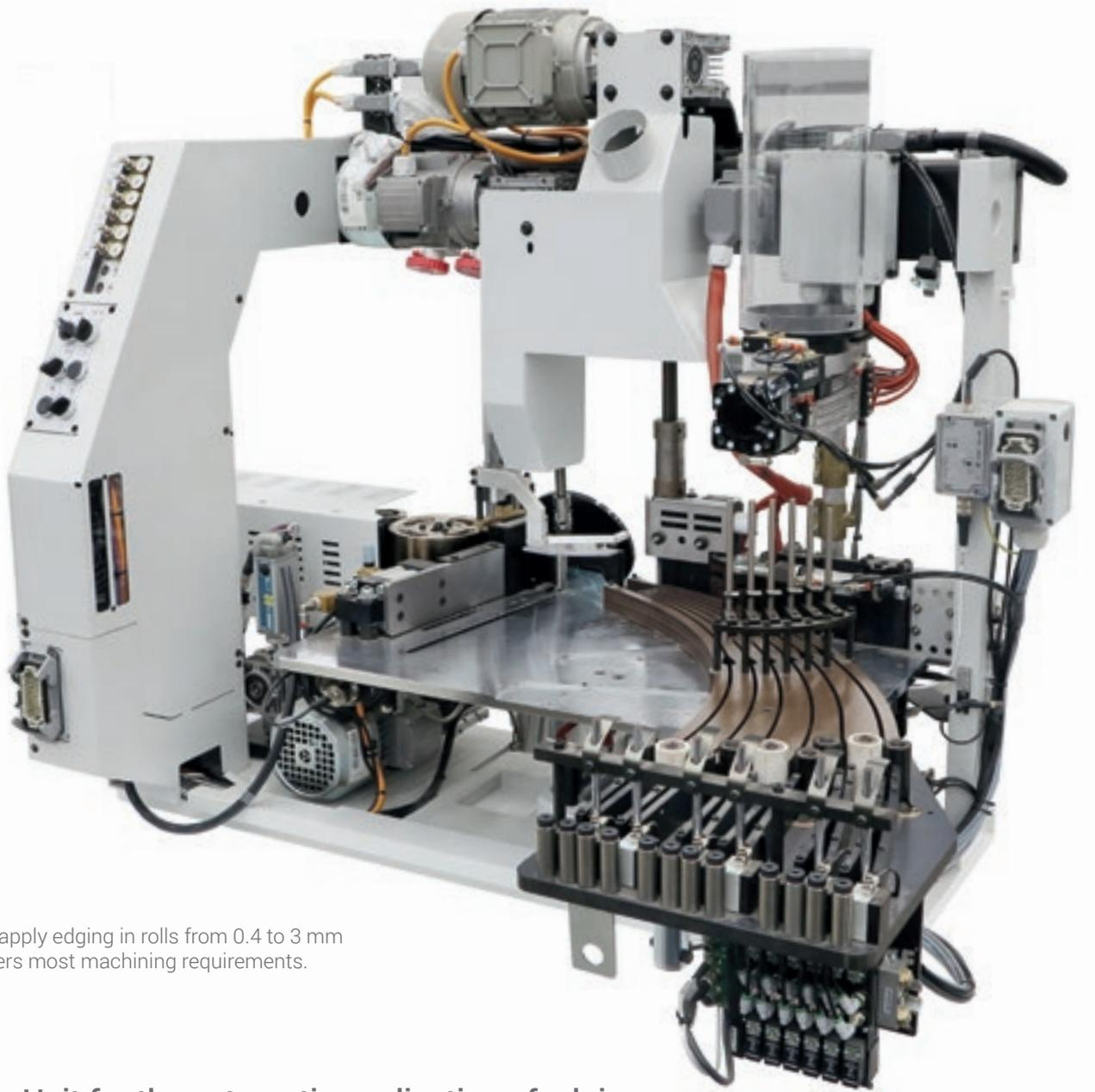

SP10

Used to apply edging in rolls from 0.4 to 3 mm and covers most machining requirements.

Gluing Unit for the automatic application of edging in rolls or strips, from 0.4 to 20 mm. It comes as standard with dedicated movement on glue roller, strip loading roller and pressure roller.

SP20

Unit specifically for machining up to 20 mm thick solid wood edging in rolls or strips.

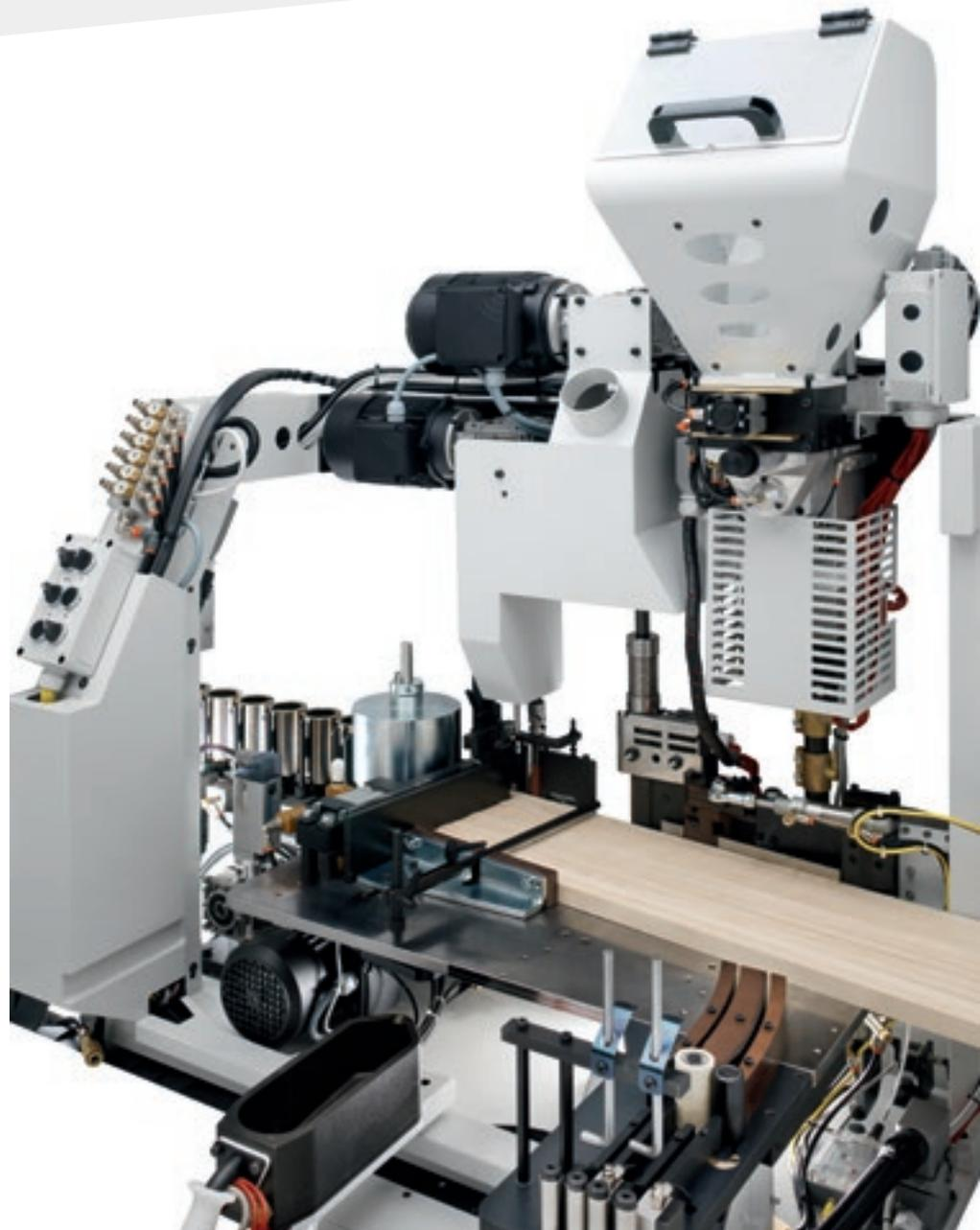

SP30

The ideal solution for machining that requires high speed and rapid setup times.

MULTIPLE SOLUTIONS FOR OPTIMUM MANAGEMENT OF GLUE

High Melt is a Biesse-patented continuous glue recycling system that keeps the machine clean without burning the glue.

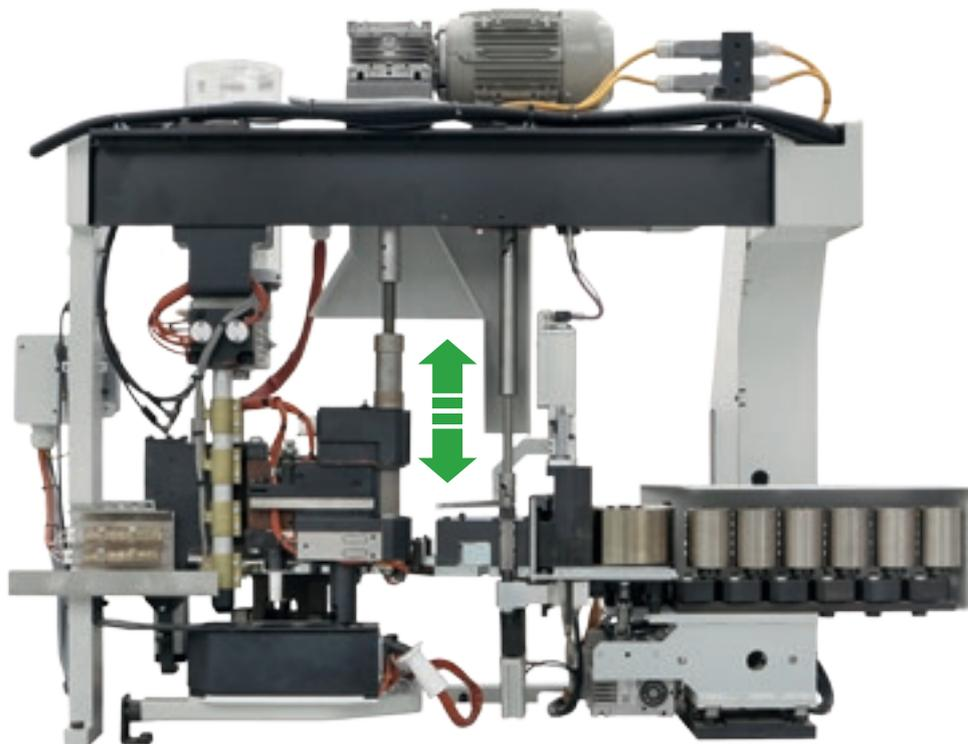
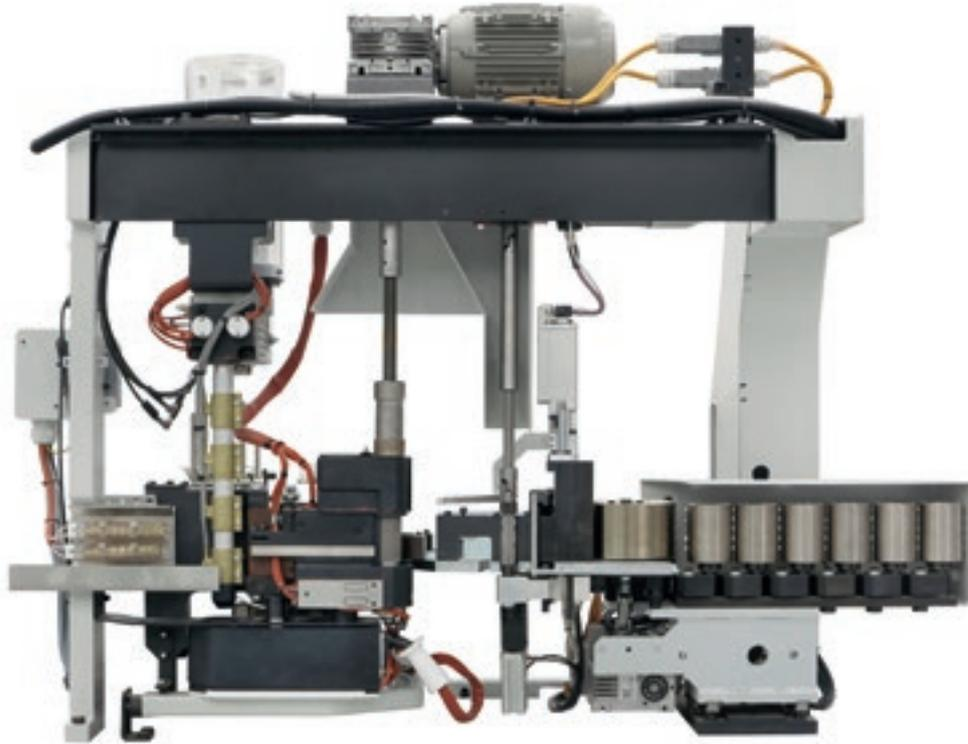

Magazine for multiple edge management. Thanks to a magazine that can house a wide combination of edges, the unit guarantees unprecedented flexibility.



Glue chuck maintenance station:

- ✔ Can be accessed to carry out maintenance on the chucks
- ✔ Specific temperature control according to the type of glue (EVA/PUR)
- ✔ Dedicated glue roller drive



gPod, the Biesse device for polyurethane glue with "PUR on demand" system for melting only the required amount of glue in real time.

The **Eva Premelter** is a pot for glue in granular form that with its large capacity guarantees constant machining for long periods in full autonomy.



↙
Nordson pre-melter for high production needs. An exclusive direct injection system for non-stop machining operations at high speed and consumption levels.

BIESSE OFFERS SPECIFIC SOLUTIONS FOR THE USE OF POLYURETHANE GLUES RESISTANT TO HEAT, HUMIDITY AND WATER.

AIR FORCE SYSTEM

INVISIBLE EDGEBANDING

No joints and no glue line, in perfect harmony with the panel.

Air Force System, available on Biesse edgebanding machines, is based on the physical principle of convection. By using a compressed hot air system, the edge bonds perfectly with the panel guaranteeing resistance to water and heat and an excellent long lasting quality finish.



FOR SUPERB PERFORMANCE AND EXECUTION

Specific solutions developed for preparing the panel for the subsequent machining phases, guaranteeing maximum precision.



The **IT90P**, a linear edge trimming unit with stepper movement for higher speeds, enables work rates of up to 30 m/ min.



MAXIMUM CUTTING QUALITY AND PRECISION THANKS TO THE END TRIMMER THAT SUPPORTS THE TRIMMING OF THE PANEL EDGE AT BOTH ENDS. VARIOUS SOLUTIONS AVAILABLE DEPENDING ON MACHINING REQUIREMENTS.



The **IT90X** linear edge trimming unit with brushless movement for high speed operations enables work rates of up to 42 m/min.

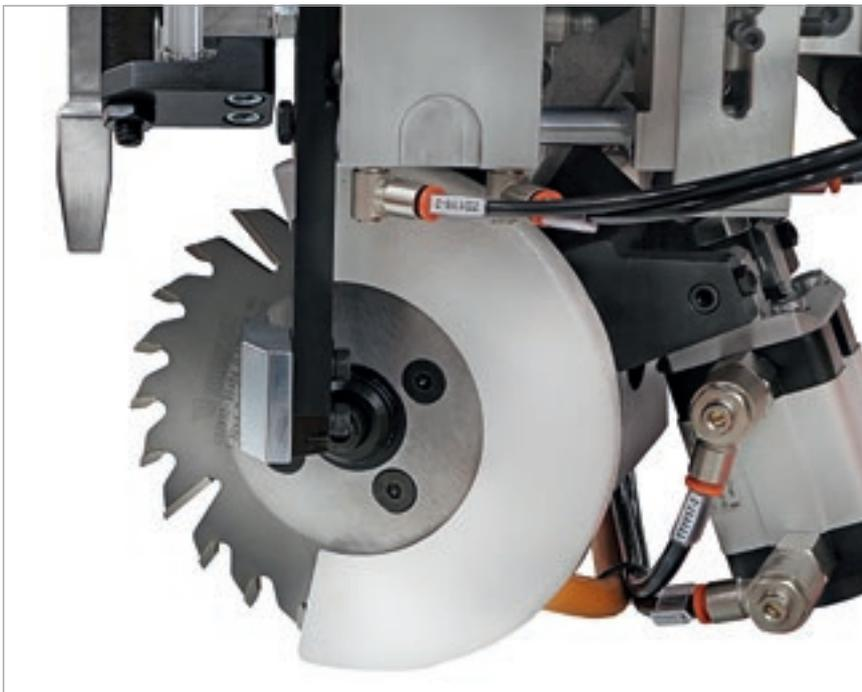

The copying and tracing system also guarantees optimal finishing quality on high-gloss edges with film.

REDUCED PRODUCTION TIME

Stream B offers personalised solutions that reduce set-up and machining times.

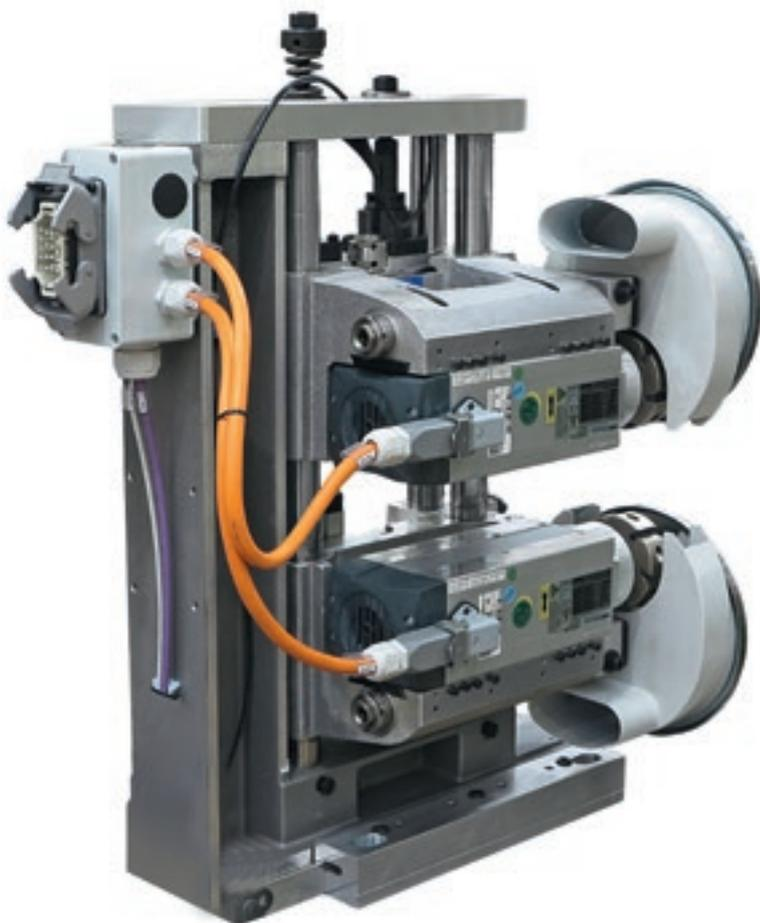

The Overlapping Rough Trimmer reduces the excess edge on the top and bottom of the panel. It also guarantees a perfect finish for solid wood, in one single movement.



Duo System is a device for the automatic changeover between the rough-shaping and finishing functions.

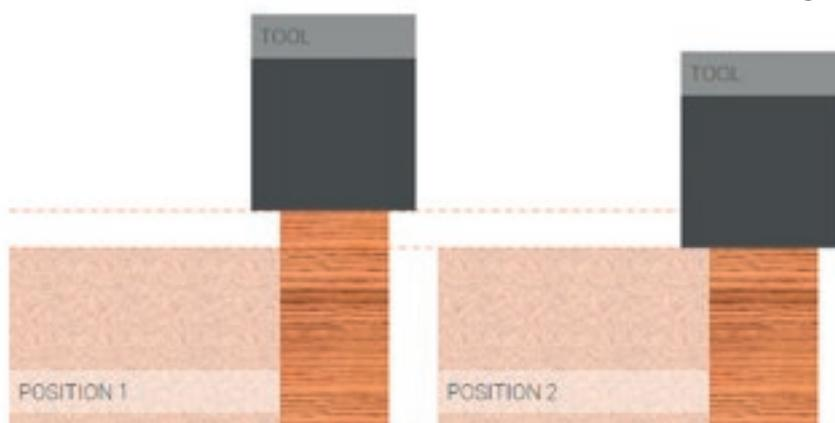

The Fine Trimming Unit trims the top and bottom of the edges with 2 high-frequency motors and vertical/front rotating disc copiers.

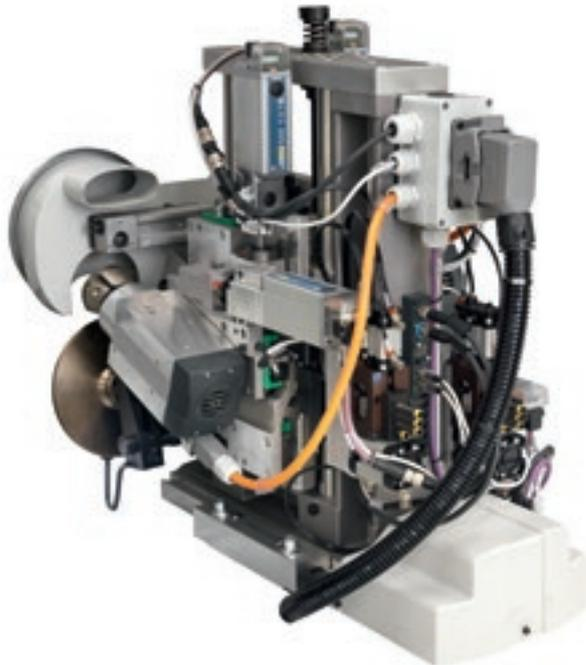

RF40

Full machining setting autonomy. The ideal solution for users who require absolute machining flexibility, thanks to full adjustment of the machine to the required edge thickness.



Nuovo RF50

Top quality thanks to the high-frequency motors (24000 rpm) and diamond-head mills.

Thanks to the 7 axes with NC control, the tool position can be adapted to even the slightest variations in the edgebanding strip and panel.

ATTENTION TO DETAIL

Solution created to meet the productivity and flexibility needs of the most demanding manufacturers.



The multi-function Corner Rounding Unit forms a radius on both the front/rear and top/bottom edges.



AR30NC

Equipped with two engines for standard machining operations.



AR34NC

Equipped with four engines to process even different materials such as rounded wood edges.



The controlled axis, fitted as standard on both version of the Corner Rounding unit, supports the management of infinite machining settings. The machine is perfectly suited to manufacturing needs.

AR80

2-motor corner-rounding unit with brushless movement for high machining speeds and maximum quality and precision.

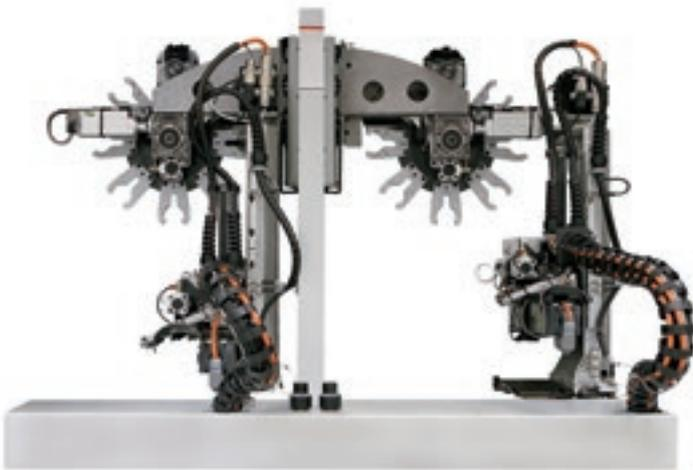
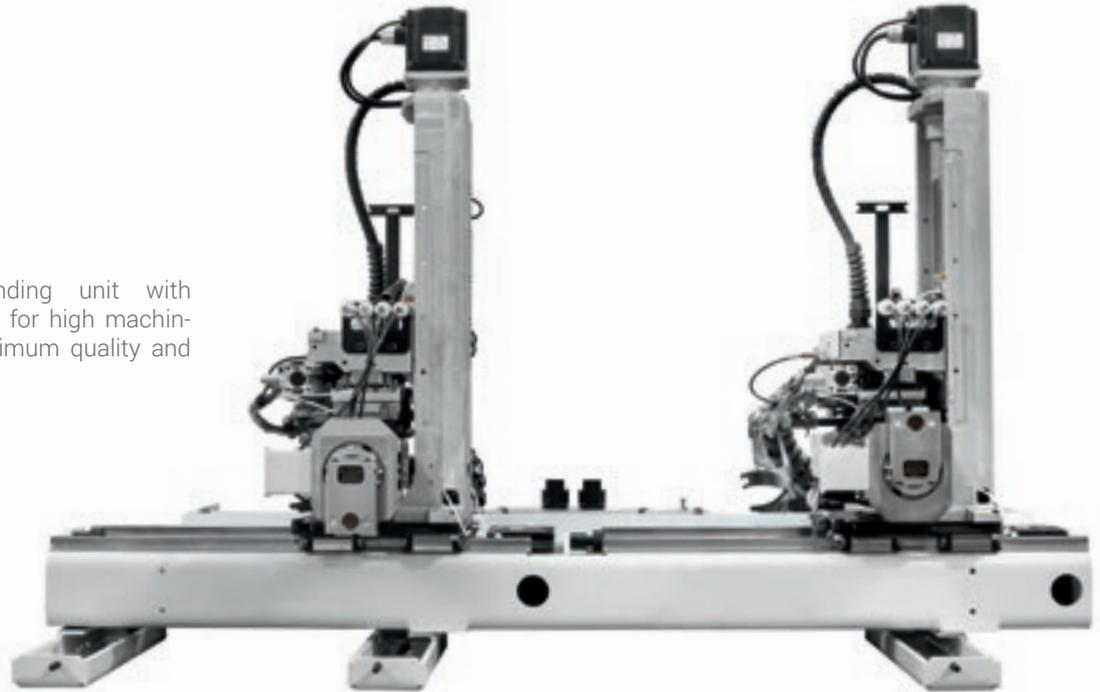

Tool change magazine

Reduction in cycle times thanks to automatic tool change for machining edges of different thicknesses.

Q-System

Q-System patented chuck with real-time profile change.



EDGE BANDING LINE

24/7 CONSTANT EDGEBANDING

No compromise on quality and productivity for consistent, excellent edgbanding.

Stream B is an edgbanding machine that can be placed in a line system. Its excellent configurability and maximum customisation make it an ideal product that embodies Biesse's high engineering skills. Stream B can be set up to operate with a right-to-left or left-to-right flow. Stream B productivity on the loading/ unloading line is much higher than a stand-alone solution both in terms of quality and performance. Stream B is the ideal solution for a company that wants to make the switch to Industry 4.0.



HIGH-QUALITY PRODUCTS

Technological solutions designed for a perfect finish, for all machining operations.

Compact machining unit with the management of 2 profiles with pneumatic settings.



The axes on the edge-scraper unit enable automatic positioning in an unlimited range of positions, in accordance with the thickness of the edgebanding strip.

THE EDGE SCRAPER ELIMINATES THE IMPERFECTIONS RESULTING FROM PREVIOUS MACHINING OPERATIONS ON THE TOP AND BOTTOM OF THE EDGE.



RB40

Positioned on the column for the complete absorption of any vibration generated on the structure, with the multiple management of controlled-axis profiles for infinite settings.



Pro-Nesting Kit

Ideal solution for edge banding of pre-drilled panels.



New RB50

Maximum flexibility thanks to one single tool for machining up to 5 different profiles.

Thanks to the 7 axes with NC control, the tool position can be adapted to even the slightest variations in the edgebanding strip and panel.

A WIDE RANGE OF MACHINING OPTIONS

Stream B technology can be used for complex machining, guaranteeing quality, precision and absolute reliability over time.

FB30

Unit with manual movement and positioning of the unit with 0-90° rotation



EB32

Equipped with a double carriage to make a channel simultaneously on the bottom and front surface of the panel.



THE GROOVING UNIT CAN BE USED FOR GROOVING AND MILLING ON THE BOTTOM, TOP AND FRONT SURFACE OF THE PANEL.



EB42

Maximum flexibility thanks to a dual electrospindle and fully controlled-axis setting management.

The motor can be replaced by an **electrospindle** for rapid blade changing.

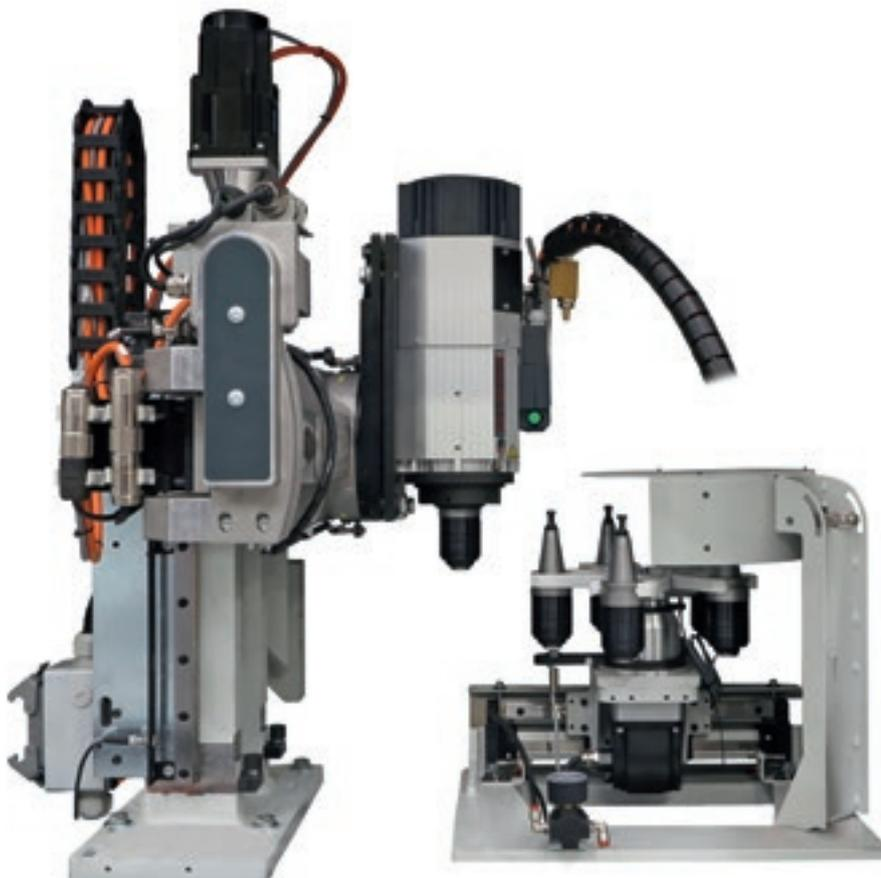

EB60

Brushless servo-controlled axis electrospindle and grooving unit. It provides extreme precision in a timed drive context. The **Tool Magazine** has 5 compartments for automatic NC tool changing.

OPTIMUM CLEANING OF PRODUCT

Multiple solutions for guaranteeing high quality product standards.



The **Glue Scraper** removes excess glue from the top and bottom of the panel. This is the only model on the market fitted with 4 pneumatic cylinders for a top quality finish.

Buffing unit for cleaning and polishing the edge and panel.



Hot air blower for reactivating the colour of the edges.

OPTIMISATION OF STAND-ALONE PROCESS



PRS EKO panel return
+ 20% productivity in a stand-alone context. Management of entire edgebanding process with just one operator.

TECHNOLOGY AT OUR USERS' DISPOSAL

Immediate, user-friendly programming thanks to the touch-screen control panel.



Advanced Statistics for monitoring productivity:

- ✔ Different types of charts available to understand and improve edgebanding machine performance
- ✔ Sub-division of the production statistics on the basis of the batch or the time gap
- ✔ Mobile app for keeping in contact with the machine status at all times.

19" control panel with SINTRA interface.

- ✔ Easy program management and usability.
- ✔ Rapid transition from one machining operation to the next.
- ✔ Modern, intuitive graphic interface.



TECHNICAL SPECIFICATIONS

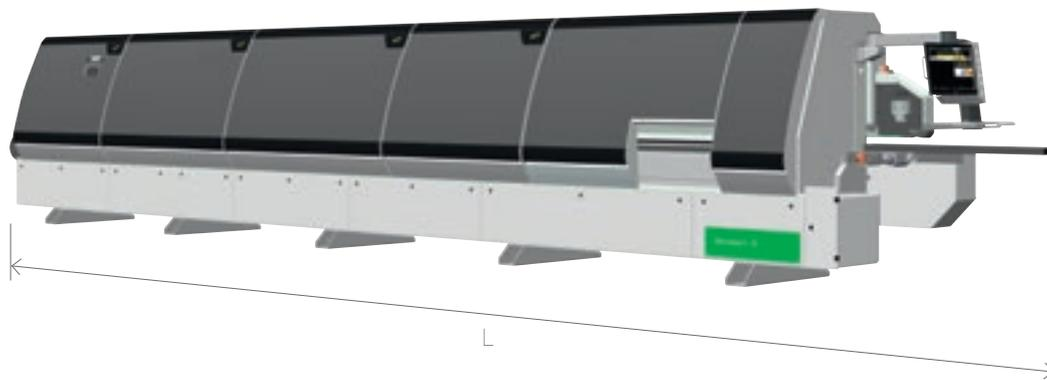

STREAM B

	L mm	L inch
Stream B 5.5	6640	261
Stream B 6.5	7640	301
Stream B 7.0	8140	320
Stream B 7.5	8640	340
Stream B 8.0	9140	360
Stream B 8.5	9640	380
Stream B 9.0	10140	399
Stream B 9.5	10640	419
Stream B 10.5	11640	458
Stream B 11.5	12640	498

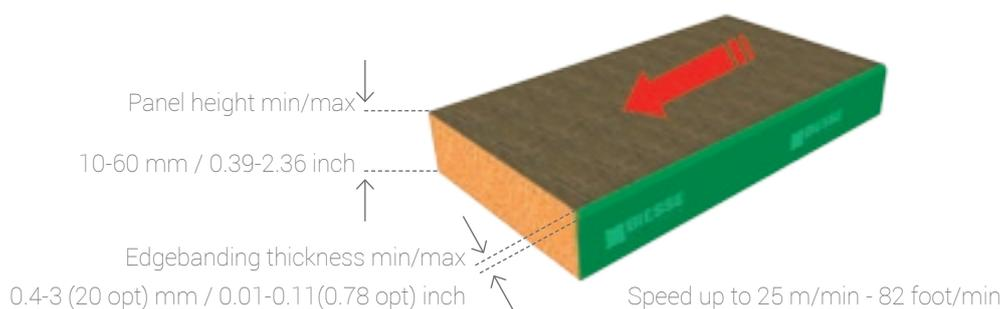

The technical specifications and drawings are non-binding. Some photos may show machines equipped with optional features. Biesse Spa reserves the right to carry out modifications without prior notice.

A-weighted sound pressure level (LpA) during machining for operator workstation on vane-pump machine Lpa=86dB(A) Lwa=106dB(A) A-weighted sound-pressure level (LpA) for operator workstation and sound power level (LwA) during machining on cam-pump machine LpA=86dB(A) Lwa=106dB(A) K measurement uncertainty dB(A) 4

The measurement was carried out in compliance with UNI EN 848-3:2007, UNI EN ISO 3746: 2009 (sound power) and UNI EN ISO 11202: 2009 (sound pressure levels at workstation) during panel machining. The noise levels shown are emission levels and do not necessarily correspond to safe operation levels. Despite the fact that there is a relationship between emission and exposure levels, this may not be used in a reliable manner to establish whether further measures need to be taken. The factors determining the exposure level for the workforce include length of exposure, work environment characteristics, other sources of dust and noise, etc. i.e. the number of other adjoining machines and processes. At any rate, the above information will enable the operator to better evaluate dangers and risks.

SOPHIA

GREATER VALUE FROM MACHINES

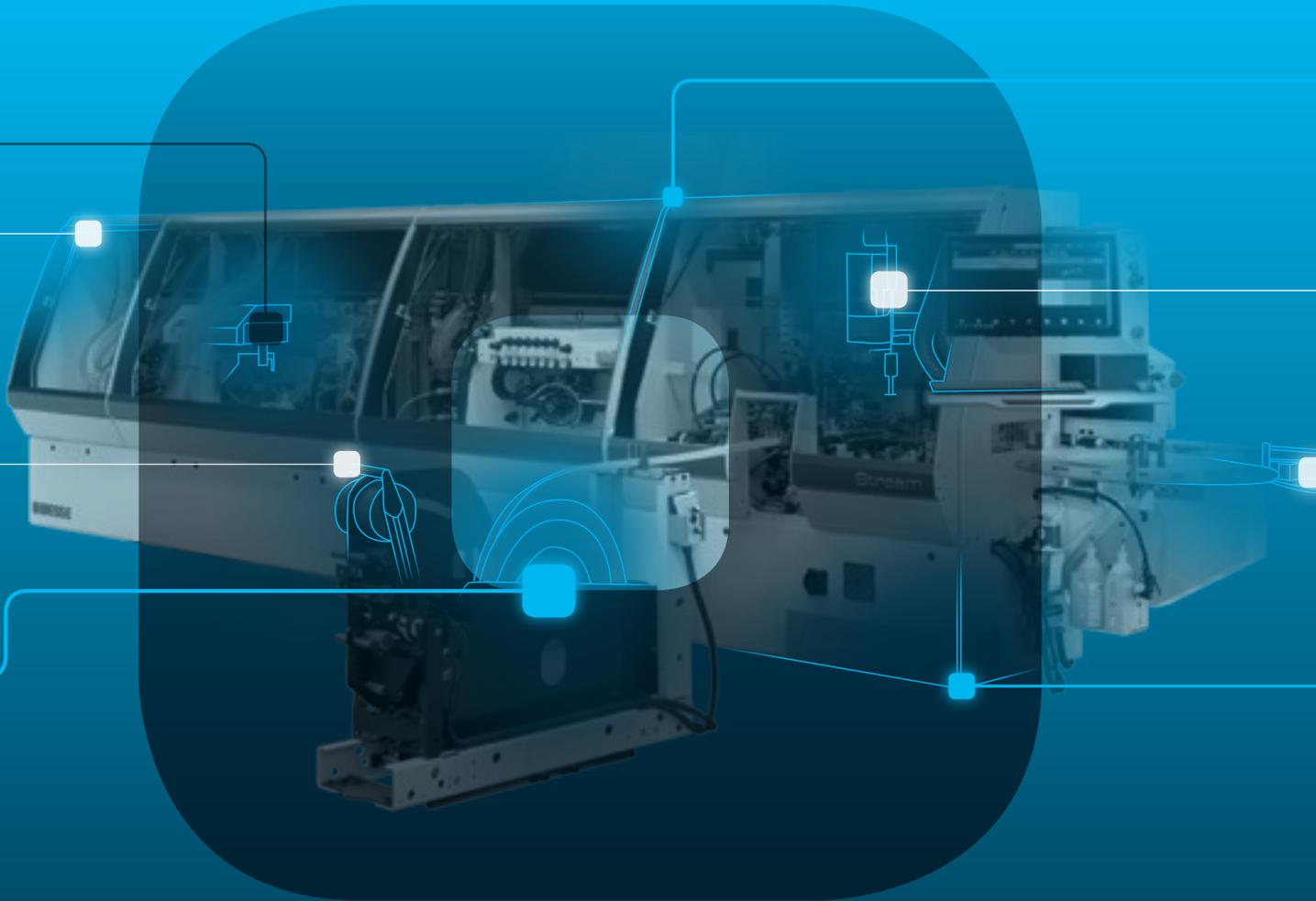

SOPHIA is the IoT platform created by Biesse in collaboration with Accenture which enables its customers to access a wide range of services to streamline and rationalise their work management processes.

It allows alerts and indicators to be sent to the customer in real time, in relation to production, the machines used and the type of process carried out. These are detailed instructions for more efficient use of the machine.

□ **10% CUT IN COSTS**

□ **50% REDUCTION
IN MACHINE DOWNTIME**

□ **10% INCREASE
IN PRODUCTIVITY**

□ **80% REDUCTION IN PROBLEM
DIAGNOSTICS TIME**

**SOPHIA TAKES THE INTERACTION BETWEEN
CUSTOMER AND SERVICE TO A HIGHER LEVEL.**

iOT
SOPHIA

IoT - SOPHIA provides a comprehensive overview of the specific machine performance features, with remote diagnostics, machine stoppage analysis and fault prevention. The service includes a continuous connection with the control centre, the option of calling for assistance from within the customer app (such calls are managed as priorities), and an inspection visit for diagnostic and performance testing within the warranty period. Through SOPHIA, the customer receives priority technical assistance.

PARTS
SOPHIA

PARTS SOPHIA is the easy new, user-friendly and personalised tool for ordering Biesse spare parts. The portal offers customers, dealers and branches the chance to navigate within a personalised account, consult the constantly updated documentation of the machines purchased, and create a spare parts purchase basket indicating the real time availability in the warehouse and the relative price list. In addition, the progress of the order can be monitored at all times.

 **BIESSE**

in collaboration with  **accenture**

SERV ICE & PARTS

Direct, seamless co-ordination of service requests between Service and Parts. Support for Key Customers by dedicated Biesse personnel, either in-house and/or at the customer's site.

BIESSE SERVICE

- ✔ Machine and system installation and commissioning.
- ✔ Training centre dedicated to Biesse Field engineers, subsidiary and dealer personnel; client training directly at client's site.
- ✔ Overhaul, upgrade, repair and maintenance.
- ✔ Remote troubleshooting and diagnostics.
- ✔ Software upgrade.

500

Biesse Field engineers in Italy and worldwide.

50

Biesse engineers manning a Teleservice Centre.

550

certified Dealer engineers.

120

training courses in a variety of languages every year.

The Biesse Group promotes, nurtures and develops close and constructive relationships with customers in order to better understand their needs and improve its products and after-sales service through two dedicated areas: Biesse Service and Biesse Parts. With its global network and highly specialized team, it offers technical service and machine/component spares anywhere in the world on-site and 24/7 on-line.

BIESSE PARTS

- ✔ Original Biesse spares and spare kits customized for different machine models.
- ✔ Spare part identification support.
- ✔ Offices of DHL, UPS and GLS logistics partners located within the Biesse spare part warehouse, with multiple daily pick-ups.
- ✔ Order fulfillment time optimized thanks to a global distribution network with de-localized, automated warehouses.

92%
of downtime machine orders fulfilled
within 24 hours.

96%
of orders delivered in full on time.

100
spare part staff in Italy and worldwide.

500
orders processed every day.

MADE WITH BIESSE

A NEW EDGEBANDING SYSTEM TO ENSURE QUALITY

Closet America, a leading home and professional closet system manufacturer headquartered in Lanham, Maryland, is proud to be the first company in the United States to incorporate the Biesse AirForce edgbanding system into its production line. "In our efforts to provide our customers with a high-quality, customised closet system along with our top-notch customer service, we were excited to invest in the Biesse AirForce system. Closet America is known for our quality closet design, our superior product and expert

installation. Our investment in the AirForce system, coupled with the use of Rehau's LaserEdge edgbanding material, is another step towards continuously exceeding our customers' expectations". The AirForce system enables companies to exploit the sustainability benefits provided by the excellent range of laser edgebands with invisible glue line. AirForce emits compressed air at a very high temperature from a special nozzle directly onto the reactive layer of the laser edgeband, thus activating the layer and welding the edgeband to the

substrate. Installing the new Stream A together with Air-ForceSystem will result in a product of an exceptional quality, apart from contributing to increasing manufacturing speed".

*Skip Labella
President of Closet America*



LIVE THE EXPERIENCE

BIESSEGROUP.COM



Interconnected technologies and advanced services that maximise efficiency and productivity, generating new skills to serve better our customer.

LIVE THE BIESSE GROUP EXPERIENCE AT OUR CAMPUSES ACROSS THE WORLD.



BIESSEGROUP

