

# cms evotech range

CNC machining centers for plastic materials processing

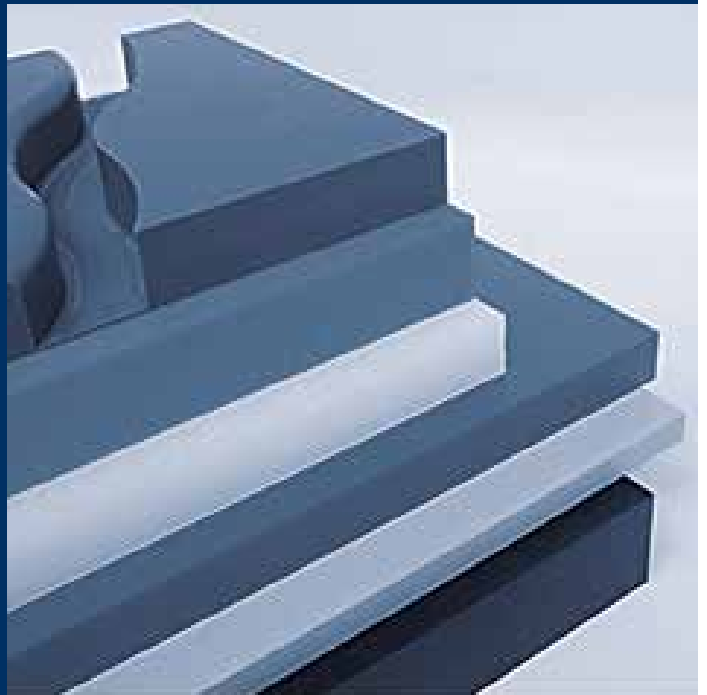

CMS is part of SCM Group, a technological world leader in processing a wide range of materials: wood, plastic, glass, stone, metal, and composites. The Group companies, operating throughout the world, are reliable partners of leading manufacturing industries in various market sectors, including the furniture, construction, automotive, aerospace, ship-building, and plastic processing industries. SCM Group coordinates, supports, and develops a system of industrial excellence in three large, highly specialized production centers employing more than 4,000 workers and operating in five continents. SCM Group: the most advanced skills and know-how in the fields of industrial machinery and components.

CMS SpA manufactures machinery and systems for the machining of composite materials, carbon fiber, aluminum, light alloys, plastic, glass, stone and metals. It was established in 1969 by Mr Pietro Aceti with the aim of offering customized and state-of-the-art solutions, based on the in-depth understanding of the customer's production needs. Significant technological innovations, originating from substantial investments in research and development and take-overs of premium companies, have enabled constant growth in the various sectors of reference.



plastic technology

**CMS Plastic Technology** produces numerically-controlled machining centers and thermoforming machines for plastic materials processing, offering technologically advanced solutions. The brand originates from the prized synergy between technical-industrial expertise in thermoforming from the historical company Villa, established in 1973, and CMS' s historical experience in milling. Thanks to constant investments in research and innovation, CMS Plastic Technology is recognized as a unique partner for entire processes: from thermoforming, to trimming, to the realization of models and molds, ensuring maximum productivity.

**CMS Plastic Technology** is in the forefront of manifold sectors, such as: automotive, aerospace, earth-moving machinery, motorhomes, buses, railway industry, bathtubs production, technical items, visual marketing, mechanical components and packaging.



# cms evotech range

<b>TECHNICAL FEATURES OVERVIEW evotech 250</b>	4-5
<b>TECHNICAL FEATURES OVERVIEW evotech 400</b>	6-7
<b>TECHNICAL FEATURES OVERVIEW evotech 500</b>	8-9
<b>ARCHITECTURE</b>	10-11
<b>TOOL CHANGERS</b>	12-13
<b>MULTI-FUNCTION WORKTABLE</b>	14-15
<b>SAFETY SYSTEMS</b>	16
<b>CONFIGURATIONS</b>	17
<b>OVERALL DIMENSIONS</b>	18
<b>TECHNICAL DATA</b>	19
<b>DIGITAL SERVICES</b>	20-21
<b>THE RANGE</b>	22-23



# 250 TECHNICAL FEATURES OVERVIEW

**cms evotech 250**

CNC machining centers for plastic materials processing

## KEY BUYER BENEFITS

- + 3 and 5 axis machining centres with mobile gantry structure dedicated to the machining of **plastic materials** and **advanced materials** and characterized by a **rigid and stable frame**
- + Spindles up to 15kw and 24.000 rpm ensure **high removal capacity** and **top finishing and accuracy levels** under any conditions
- + The aluminium worktable is characterized by perfect **planarity**, ensuring **clamping accuracy** and **advanced nesting** machining even with the **most severe machining operations on technical details**
- + Gantry structure driven by a **highly dynamic dual motor**. **Solution dedicated to the processing of plastic materials and advanced materials**

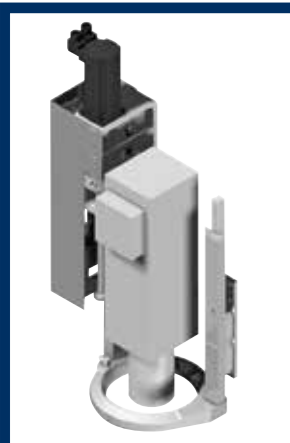

**Synchron electronic copying device.** This device ensures milling of the top surface of the work-piece at constant-depth through the synchronised movement of the Z-axis.

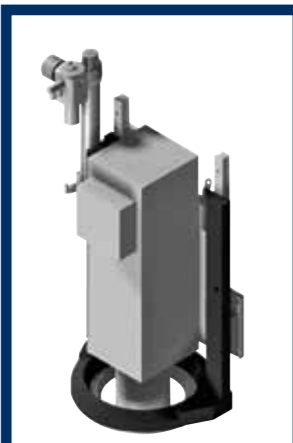

**Mechanical co-axial presser** indispensable when clamping small-size workpieces and in the machining of technical articles from plastic material sheets.



**Maximum cleaning** of the machine and the working environment due to the double coaxial dust extraction hood that allows the suction of shavings and sawdust in any condition of use.



**Side tool store** up to 12 positions.



**Multi-function worktable** suitable for any reference and workpiece clamping needs. The most flexible solution for any need when clamping plastic material parts.



**Chain tool store** with 32 positions anchored to the mobile gantry structure, developed for managing heavy and large tools.

**Maximum operator safety** thanks to the compact bumper protections.



**Total absence of vibrations** even at high speed with the gantry structure driven by a dual motor. Solution dedicated to the processing of plastics and advanced materials.

# TECHNICAL FEATURES OVERVIEW

**cms evotech 400**

CNC machining centers for plastic materials processing



The MACH 5 device in only five seconds replaces the tool drastically reducing down-times.

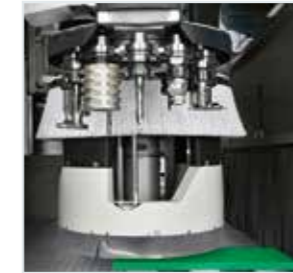

**Maximum cleaning** of the machine and the working environment due to the double coaxial dust extraction hood that allows the suction of shavings and sawdust in any condition of use.

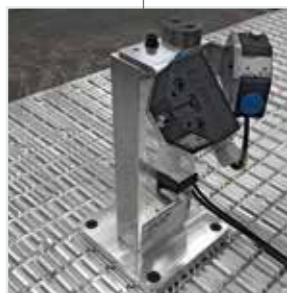

Guaranteed accuracy of the 5-axis with the RTCP setting (Rotation Tool Center Point system) that automatically re-adjust the machining head parameters through a self-calibration system and a software function available on the machine.

**Multi-function worktable** suitable for any reference and workpiece clamping needs. The most flexible solution for any need when clamping plastic material parts.

**Maximum operator safety** thanks to the compact bumper protections.



**Total absence of vibrations** even at high speed with the gantry structure driven by a dual motor. Solution dedicated to the processing of plastics and advanced materials.

# TECHNICAL FEATURES OVERVIEW

**cms evotech 500**

CNC machining centers for plastic materials processing

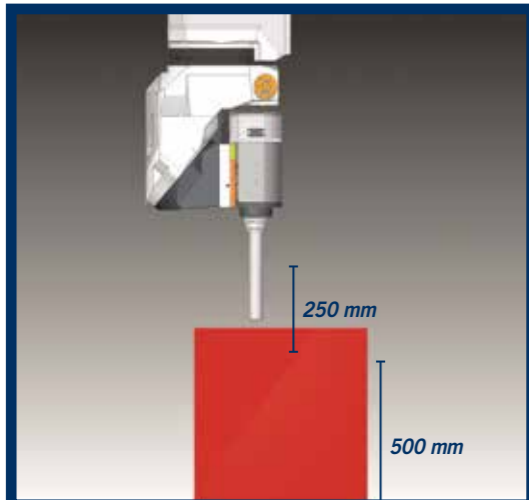

The increased stroke of the vertical axis allows machining of work-pieces up to 500 mm in height, using large dimensioned tools.



**Maximum cleaning** of the machine and the working environment due to the double coaxial dust extraction hood that allows the suction of shavings and sawdust in any condition of use.



**PRISMA machining head** with 5 axes electrospindle.



**Circular tool store with 12 positions**, located on the machining head.

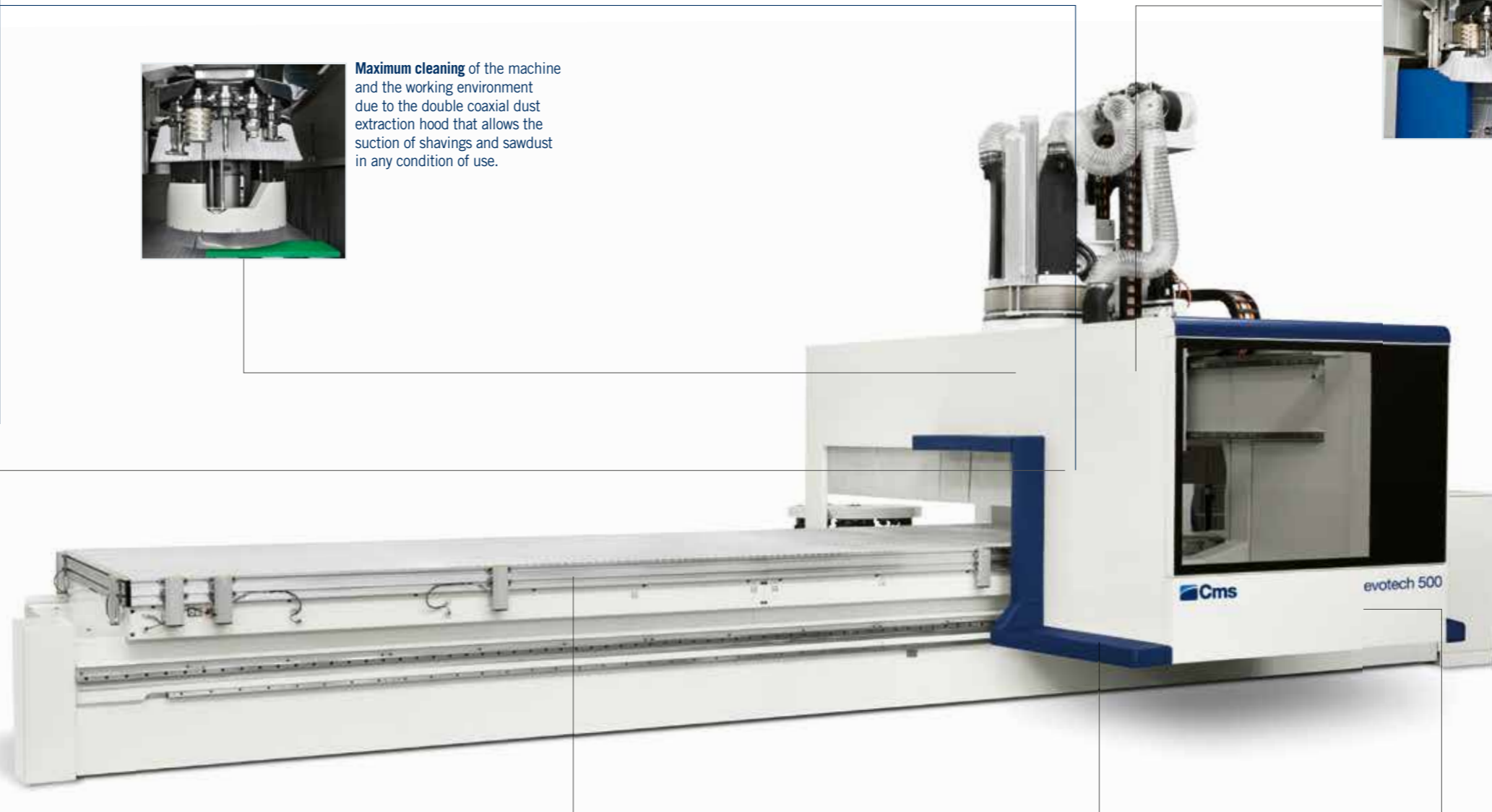

**Multi-function worktable** suitable for any reference and workpiece clamping needs.

The most flexible solution for any need when clamping plastic material parts.

**Maximum operator safety** thanks to the compact bumper protections.



**Total absence of vibrations** even at high speed with the gantry structure driven by a dual motor. Solution dedicated to the processing of plastics and advanced materials.



# ARCHITECTURE

## HIGH LEVEL TECHNICAL STRUCTURE FOR PLASTIC MATERIALS PROCESSING

### MOBILE GANTRY STRUCTURE

The machines of evotech series are designed with a sturdy and highly ribbed mobile gantry structure that ensures maximum finish quality, accuracy and productivity.

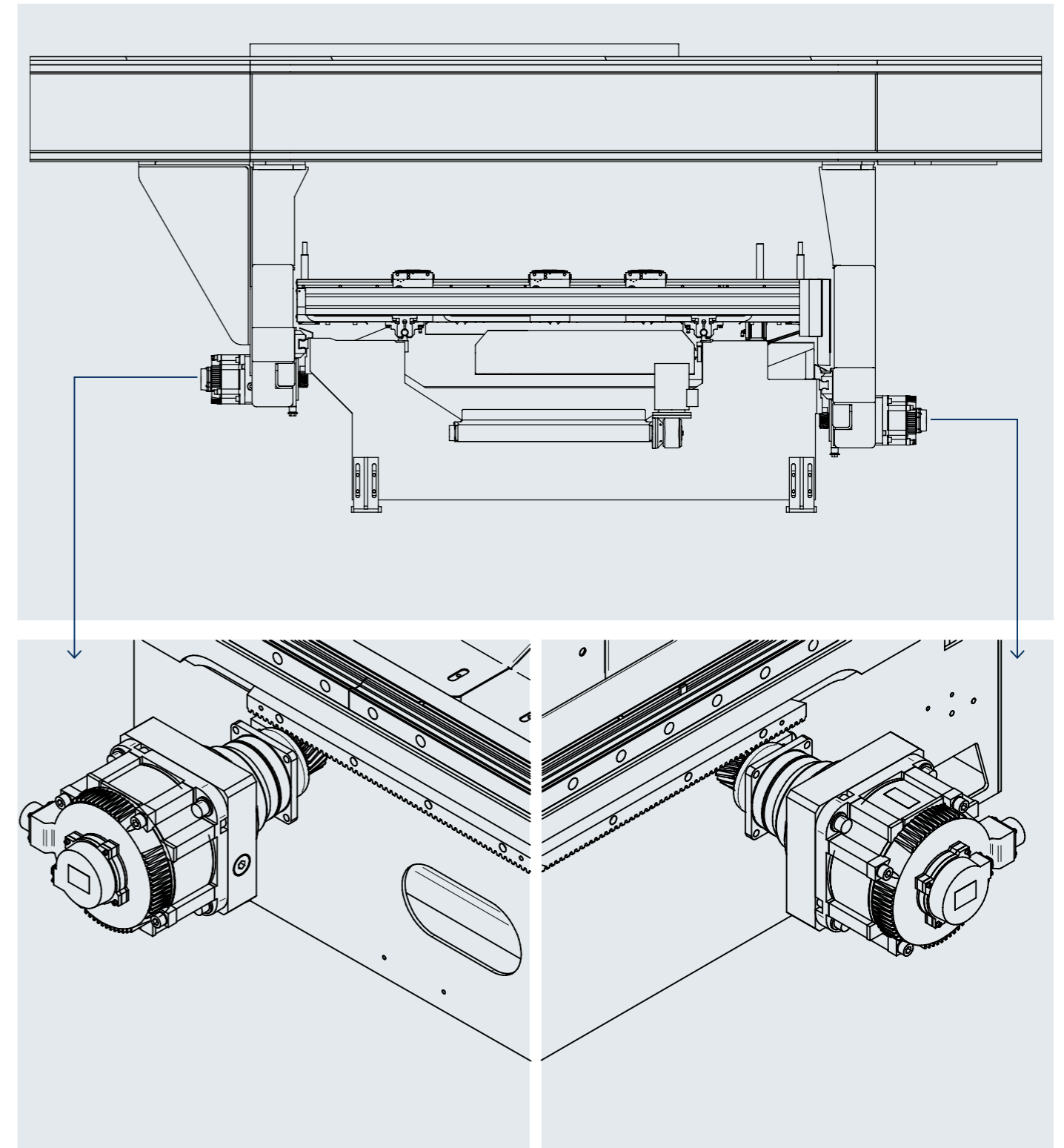
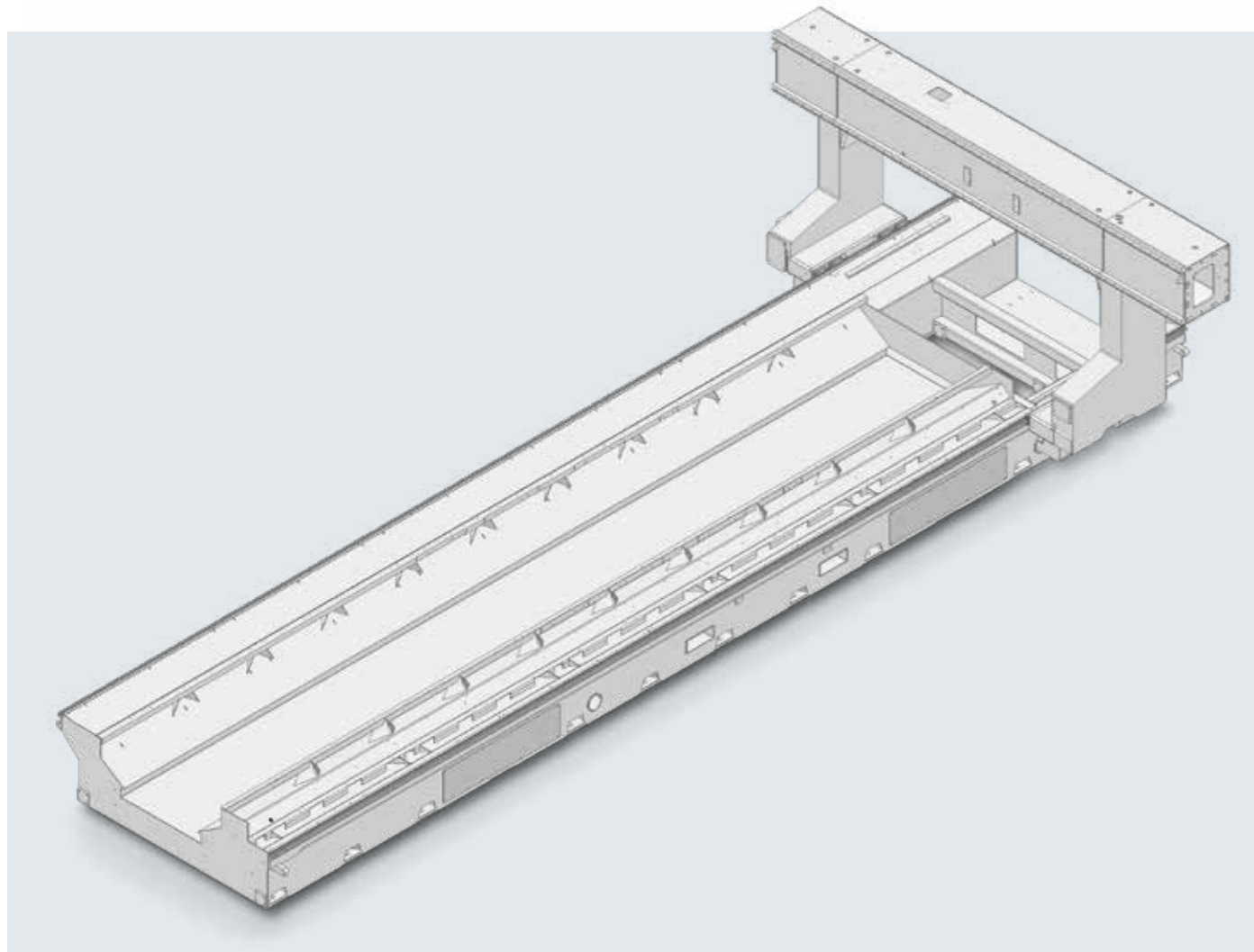

The movement of the X axis is obtained by means of a gantry system with double rack and double motorization, to ensure maximum accuracy and speed of movement, as necessary in the processing of plastic and advanced materials characterized by the highest technological content.

# TOOLS CHANGERS

**cms evotech range**

CNC machining centers for plastic materials processing



**TRC**  
**48 or 32 positions**  
Chain tool store anchored to the mobile gantry structure, developed for managing heavy and large tools.



**RAPID**  
**24 or 16 positions**  
Circular tool store anchored to the mobile gantry structure, to have the most tools available.

**MACH 5**  
In only five seconds, it replaces the tool drastically reducing down-times.



**RAPID 12 ON-BOARD**  
**12 positions**  
Circular tool store located on the machining head, it allows the tool change during drilling operations.



**TR 12**  
**12 positions**  
Maximum efficiency with the side tool store positioned on the right side of the worktable.



# MULTI-FUNCTION WORKTABLE



## MULTI-FUNCTION WORKTABLE

The aluminium worktable ensures maximum processing reliability. Characterized by perfect planarity, it guarantees clamping and machining accuracy both in nesting operations and in the processing of advanced materials components.

The vacuum system is formed directly within the extruded aluminium parts and distributed on a grid of holes spaced at 120 mm on the whole surface of the worktable.

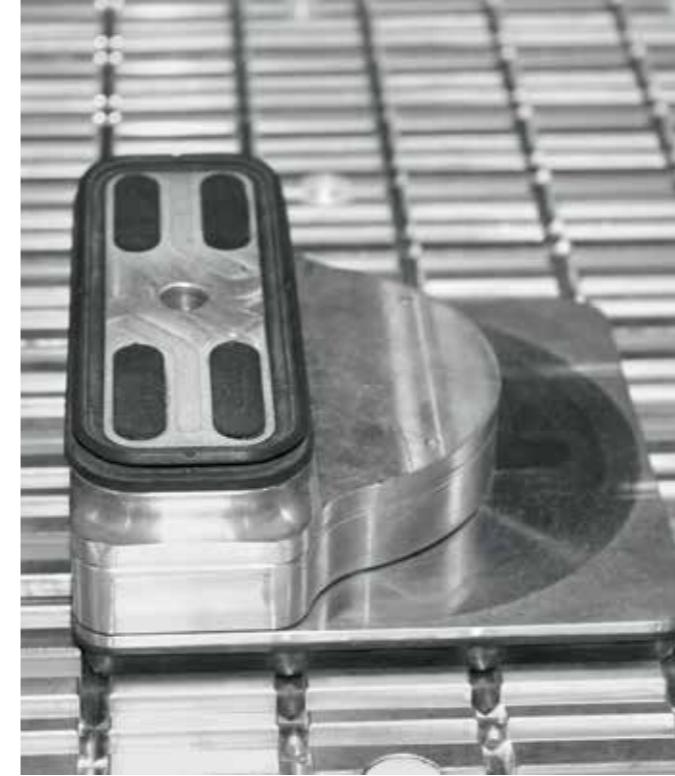
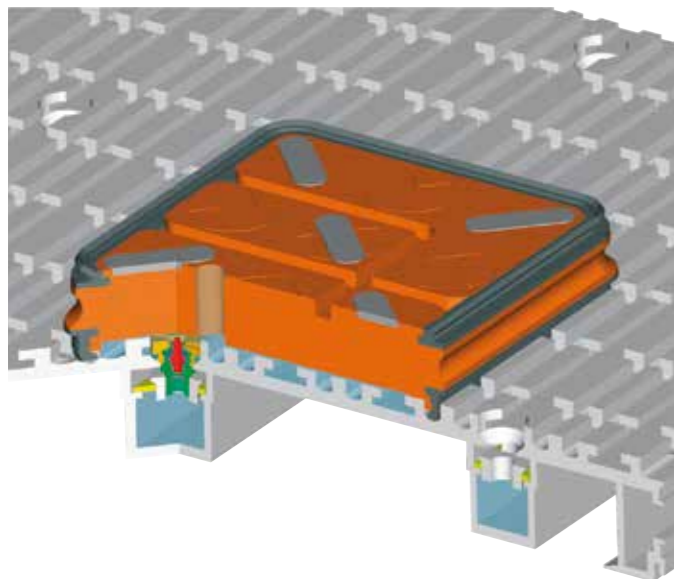

On the entire surface of the worktable there are T-grooves that allow the firm locking of any additional equipment.



It is possible to configure the worktable with countless types of MPS suction cups, adding or removing them easily, depending on the type and geometry of the parts to be clamped. Ideal solution in the production of technical articles made of plastic materials.

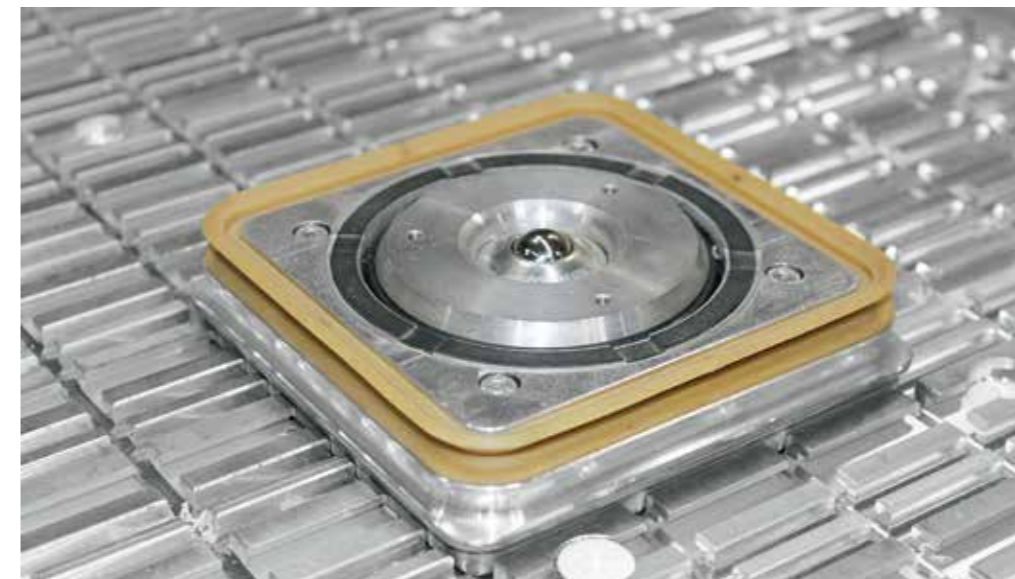



# SAFETY SYSTEMS



The machining head cover is equipped with compact bumper protections, enabling the use of the entire work area, and the positioning of several pieces on the worktable all at the same time.

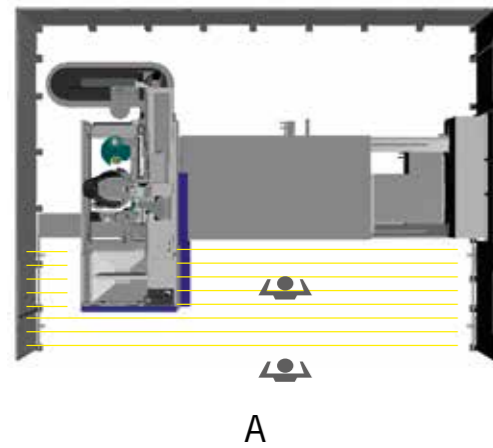

## PRO-SPEED

The safety system with horizontal photocells and bumper protections, combines total access to the worktable and maximum operator's safety during work-piece loading and unloading. When machining, the top speed can be reached for higher productivity.

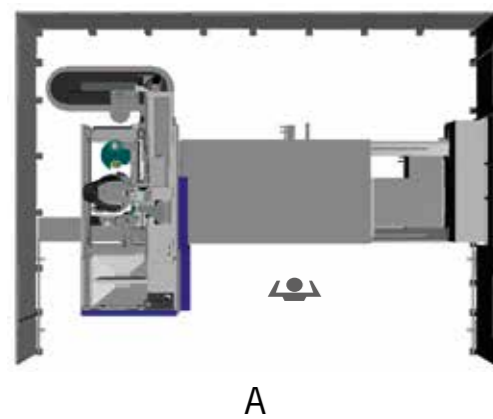

## PRO-SPACE

Designed to minimise the machine footprint while guaranteeing maximum operator's safety thanks to the bumper protections installed on the mobile gantry structure. During machining, the speed is limited to max. 25 m/min.

# CONFIGURATIONS

cms evotech range

CNC machining centers for plastic materials processing

	EVOTECH 250	EVOTECH 400	EVOTECH 500
PRISMA 5 axes machining head	✓	✓	✓
3 axes machining head	✓	✓	-
Drilling unit	✓	✓	✓
Deflector on electrospindle	✓	✓	✓
MACH 5 tool change device	-	✓	-
TRC 48 tool store	-	✓	✓
TRC 32 tool store	✓	-	✓
RAPID 24 tool store	✓	✓	✓
RAPID 16 tool store	✓	✓	✓
RAPID 12 ON-BOARD tool store	✓	✓	✓
TR 12 tool store	✓	✓	✓

# OVERALL DIMENSIONS

## MULTI-FUNCTION WORKTABLE

WORKING AREA X-Y-Z		PRO-SPEED		PRO-SPACE	H
		A	B	B	
<b>EVOTECH 250</b>					
3650 x 1600 x 250	mm	7550	5100	4240	2850
4970 x 1600 x 250	mm	8880	5100	4240	2850
6170 x 1600 x 250	mm	10220	5100	4240	2850
3650 x 2120 x 250	mm	7550	5500	4570	2850
4970 x 2120 x 250	mm	8880	5500	4570	2850
6170 x 2120 x 250	mm	10220	5500	4570	2850
<b>EVOTECH 400</b>					
3650 x 1600 x 350	mm	8520	5960	5250	3000
4970 x 1600 x 350	mm	9820	5960	5250	3000
6170 x 1600 x 350	mm	11250	5960	5250	3000
3650 x 2120 x 350	mm	8520	6500	5650	3000
4970 x 2120 x 350	mm	9820	6500	5650	3000
6170 x 2120 x 350	mm	11250	6500	5650	3000
<b>EVOTECH 500</b>					
3650 x 1600 x 500	mm	8440	5700	4670	3600
4970 x 1600 x 500	mm	9850	5700	4670	3600
6170 x 1600 x 500	mm	11130	5700	4670	3600
3650 x 2120 x 500	mm	8440	6260	5100	3600
4970 x 2120 x 500	mm	9850	6260	5100	3600
6170 x 2120 x 500	mm	11130	6260	5100	3600

# TECHNICAL DATA

**cms evotech range**  
CNC machining centers for plastic materials processing

		EVOTECH 250	EVOTECH 400	EVOTECH 500
<b>AXES</b>				
X-Y-Z axes max. speed (PRO SPEED version)	m/min	60-60-30	90-90-30	95-90-30
X-Y-Z axes max. speed (PRO SPACE version)	m/min	25-60-30	25-90-30	25-90-30
Z axis work-piece passage (max.)	mm	250	350	350
<b>MACHINING HEAD</b>				
Axes electrospindle motor power (max)	kW	12	17	12
3/4 axes electrospindle motor power	kW	15	15	21
5 axes electrospindle 5 rotation speed (max.)	rpm	24.000	24.000	24.000
3/4 axes electrospindle rotation speed (max.)	rpm	24.000	24.000	24.000
<b>DRILLING UNIT</b>				
Vertical and horizontal spindles (max.)	n.	30	30	26
Rotation speed	rpm	8.000	8.000	8.000
<b>TOOL CHANGERS</b>				
Tool store on machining head	position	12	12	12
Rear tool store	position	32	48	48
Side tool store	position	12	12	-
Front tool store	position	-	-	16
<b>INSTALLATION</b>				
Exhaust air consumption	m³/h	4430	4430	4430
Compressed air consumption (min.-max.)	NI/min	350-550	350-550	350-550





## Maestro cnc

In the office, before the production, the design and programming system Maestro cnc ensures that routing, drilling or sawing can quickly and easily be programmed thanks to 3D graphics of work pieces and machining and clamping aids as well as a smart App and macros library to program any machine operation with a mouse click.

Another click away and CNC programs are automatically generated.

### SOFTWARE

#### Office



## Maestro active cnc

Maestro active is our new operator interface software which has been A single operator can easily and confidently run multiple machines due to controller and interface consistency: regardless the machine, Maestro active maintains the same look&feel, with many identical icons and navigation buttons, thus ensuring the same approach to interaction.

### EASE OF USE

The new interface has been specifically designed and optimized for immediate use via touch screen. Graphics have been redesigned for simple and comfortable navigation, with tablet-like icons on touch screen controller.

### "ZERO" ERRORS

Improved productivity thanks to integrated help and recovery procedures that reduce the possibility of error from the operator's side.

### SOFTWARE

#### Factory

## Maestro cnc

### ADDITIONAL FUNCTIONS

## THE SOFTWARE THAT SIMPLIFIES THE WORK

CAD/CAM programming software to design all the production processes. Developed in Windows® environment it ensures easy programming with an advanced, simple and intuitive sketching environment that features all the tools necessary to design the parts, their layout on the work table, tools management and the relative machining operations. All the procedures are contained in a perfectly integrated and high performance software.



### Maestro pro view - Unique in the simulation of 3D objects

3D simulator allows to have in office the three-dimensional model of the machine and to visualize in advance all the machinings that will be done during production



### Maestro 3d - Unique in the creation of 3D objects

The module integrated in the Maestro suite is designed to program three dimensional objects on 5-axis machining centres.



### Maestro apps - Unique know-how

Maestro apps is a library of programming functions that are always available and easy to use, developed Specifically for plastic materials processing.



### Maestro msl connector - Total integration

Connector for third-parties with design software.

## Maestro active cnc

## AN INNOVATIVE INTERACTION WITH YOUR CMS MACHINE FOR PLASTIC MATERIALS PROCESSING

### FULL CONTROL OF PRODUCTION PERFORMANCES

The creation of customizable reports by operator, shift, program, forecast period (and much more) allowsto monitor, optimize and improve the production performance.

### FULL MACHINE AWARENESS AND KNOWLEDGE MANAGEMENT SYSTEM

Maestro active allows to record the times related to setup, maintenance, training and other events, tracing all the activities in a database. The operator's know-how is also stored and made available to other people inside the organization thanks to the possibility to comment and document all production events or notifications.

### ORGANIZE YOUR PRODUCTION

Maestro active allows to create different users with different roles and authorizations (e.g.: operator, maintainer, administrator, ...). Any user can only execute the functions whose permissions have been assigned to him. It is also possible to define the work shifts on the machine and then detect activities, productivity and events that occurred in each shift.

### TOTAL QUALITY OF THE FINISHED PRODUCT

With Maestro active the quality of the finished piece is no longer put at risk by worn tools. The new Maestro Active Tool Life Determination system sends notification messages as the tool reaches its end of life and recommends its replacement at the most appropriate time.

### TOOLS? NO PROBLEM!

Maestro active guides the operator during the magazine tooling phase, taking into account the programs to be executed.

# THE RANGE OF CMS PLASTIC TECHNOLOGY

# FOR PLASTIC PROCESSING

## 3/4-AXIS CNC MACHINING CENTERS



TRACER



TIME



EVOTECH

## BEAM SAWS



HELIX

## BAND SAWS



T-MAXI

## 5 AXIS CNC MACHINING CENTERS



ATHENA



ANTARES



ARES



MX5

## THERMOFORMING MACHINES



BR5



BR5 CS



BR5 S



BR5 HP



BR5 SPECIAL SPA



MASTERFORM





**C.M.S. SPA**

via A. Locatelli, 123 - 24019 Zogno (BG) - IT

Tel. +39 0345 64111

[info@cms.it](mailto:info@cms.it)

[cms.it](http://cms.it)

a company of **scm**group