

# cms tracer 200x/300x

CNC machining centers for plastic materials processing

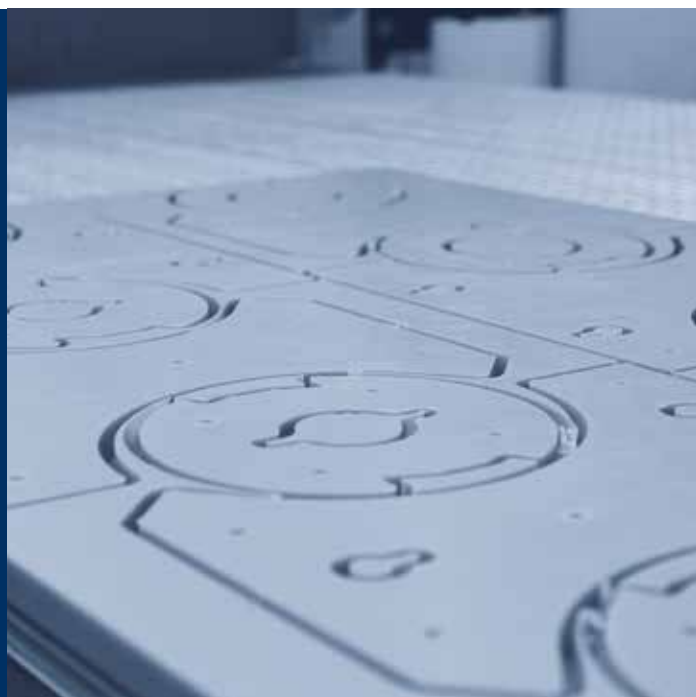

CMS is part of SCM Group, a technological world leader in processing a wide range of materials: wood, plastic, glass, stone, metal, and composites. The Group companies, operating throughout the world, are reliable partners of leading manufacturing industries in various market sectors, including the furniture, construction, automotive, aerospace, ship-building, and plastic processing industries. SCM Group coordinates, supports, and develops a system of industrial excellence in three large, highly specialized production centers employing more than 4,000 workers and operating in five continents. SCM Group: the most advanced skills and know-how in the fields of industrial machinery and components.

CMS SpA manufactures machinery and systems for the machining of composite materials, carbon fiber, aluminum, light alloys, plastic, glass, stone and metals. It was established in 1969 by Mr Pietro Aceti with the aim of offering customized and state-of-the-art solutions, based on the in-depth understanding of the customer's production needs. Significant technological innovations, originating from substantial investments in research and development and take-overs of premium companies, have enabled constant growth in the various sectors of reference.



**CMS Plastic Technology** produces numerically-controlled machining centers and thermoforming machines for plastic materials processing, offering technologically advanced solutions. The brand originates from the prized synergy between technical-industrial expertise in thermoforming from the historical company Villa, established in 1973, and CMS' s historical experience in milling. Thanks to constant investments in research and innovation, CMS Plastic Technology is recognized as a unique partner for entire processes: from thermoforming, to trimming, to the realization of models and molds, ensuring maximum productivity.

**CMS Plastic Technology** is in the forefront of manifold sectors, such as: automotive, aerospace, earth-moving machinery, motorhomes, buses, railway industry, bathtubs production, technical items, visual marketing, mechanical components and packaging.

# cms tracer 200x/300x

<b>TECHNICAL FEATURES OVERVIEW</b>	4-5
<b>SAFETY SYSTEMS</b>	6-7
<b>NESTING AND MUCH MORE</b>	8
<b>TOOL CHANGERS</b>	9
<b>WORK TABLES</b>	10-11
<b>LOADING AND UNLOADING</b>	12-13
<b>OVERALL DIMENSIONS</b>	14
<b>TECHNICAL DATA</b>	15
<b>DIGITAL SERVICES</b>	16-17
<b>THE RANGE</b>	18-19



# TECHNICAL FEATURES OVERVIEW

**cms tracer 200x/300x**  
CNC machining centers for plastic materials processing

The new generation of 3, 4, 5-axis CNC nesting centres for drilling and routing. Models are also available in cell version with both automatic loading and unloading belt.

## KEY BUYER BENEFITS

- + **“All in one”** machining centre, 3 and 5 axes for the processing of **plastic materials** and **advanced materials**, equipped with technical solutions especially dedicated to the **advanced nesting** and the **technical article**
- + **Best-in-class wide spindle and head range** for all machining needs up to 15kw and 24.000 rpm
- + **Incomparable optimization of encumbrance** thanks to the available “pro-speed” and “pro-space” solutions
- + Worktables with **unique vacuum management solutions**, thanks to the dynamic **X-Vacuum** system

**Console with integrated PC**, industrial PC with multi-touch color display, 21,5” screen size, Full HD, positioned on a support base with displacement wheels, for an easy handling of the mobile console along the machine perimeter.



**Faster machining cycles** thanks to **FAST** tool changer with 12, 14, 18 positions.



**Tools are always available** thanks to the **R16** rear tool changer.



**Maximum effectiveness in all machining situations**  
The pressure roller solution ensures the perfect clamping of parts such as plastic strips and profiles, small nesting parts and overlapping panels. On the whole, a perfect seal is provided in conditions of poor vacuum tightness. In the case of operations that do not involve the use of pressure rollers, these are excluded while maintaining the full performance of the machine unchanged.



3-, 4-, 5-axis main electrospindle



**All at your fingertips** with the **TECPAD 7"** remote control with color touch-screen.

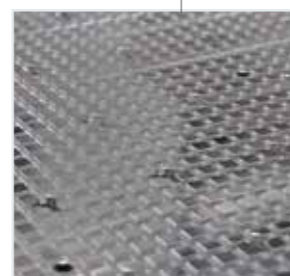

**Sturdy, practical and resistant** “PHE” (Phenolic High Efficiency) and “HE” (High Efficiency) work tables.



**Wide range of specific pods** suitable for both HE work table and spoilboard.



**TRB** tool changer with 11, 14, 16 and 19 positions.

# SAFETY SYSTEMS FOR PLASTIC MATERIALS PROCESSING

**cms tracer 200x/300x**  
CNC machining centers for plastic materials processing

## GUARANTEED SAFETY: BUMPERS PROTECTIONS

Fully safe machining with the bumpers safety system which locks the machine only in case of accidental contact with the operator.



## MINIMUM OVERALL DIMENSIONS, MAXIMUM SAFETY AND FLEXIBILITY: PRO-SPACE

The absence of perimeter fences facilitates the work table access on all the sides of the machine; panels can be loaded and unloaded from both the rear and front side thanks to the control devices located on both sides. The protections allow the machine to be used with a feed speed up to 25 m/min along the horizontal X-axis.

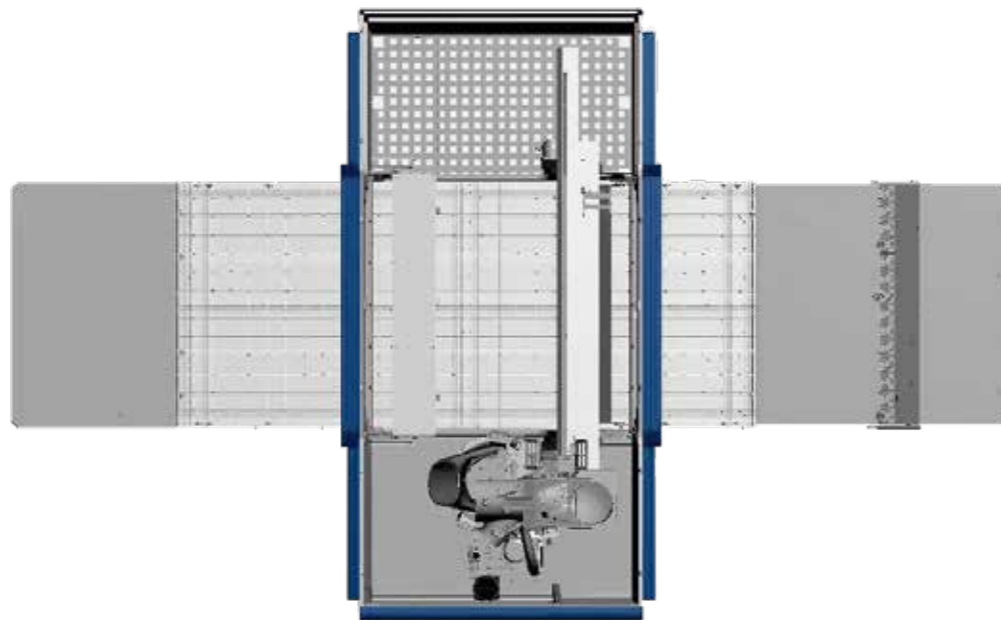

## TOTAL FREEDOM AND HIGH PRODUCTIVITY: PRO-SPEED

Protection system for the machine use to the maximum speed. When the operator enters into the loading area, which is delimited by the front photocell barrier, the machine automatically reduces the speed; when the operator leaves the loading area, the system restores the maximum speed.

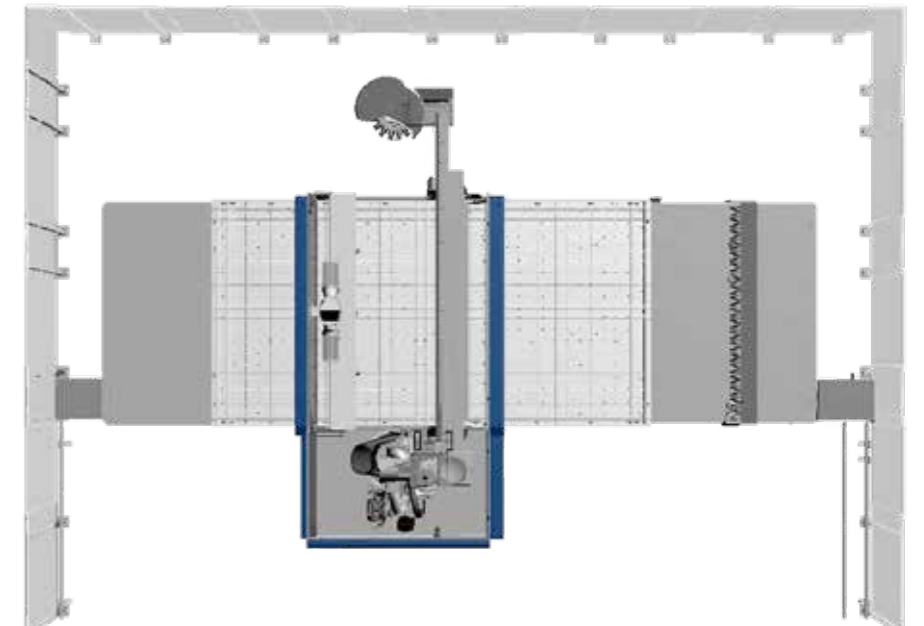

# NESTING AND MUCH MORE

**JQX ELECTROSPINDLE** The JQX (Just Quality eXtreme) 5-axis electrospindle features direct drive and up to 12 kW of power, ensures utmost machining freedom and total quality in the processing of technical articles made of plastic materials. These specifications enable the tracer 300x to meet all nesting and 5-axis machining needs with maximum performance.



Easy cutting and grooving operations along X and Y direction thanks to the 0°-90° blade unit.



Higher efficiency and machining time reduction with the up to 5,4 kW additional routing unit.

# TOOL CHANGERS

**cms tracer 200x/300x**  
CNC machining centers for plastic materials processing



\* For all the configurations is available the "Pick-up" tool changer fitted on the mobile cross beam. Ideal set-up for tools and large sized angular heads.



**TOOL LENGTH DETECTION DEVICE**  
Positioned on the machine base side, it allows to automatically detect the length of the tool.



**TRB** side tool changer with up to 19 positions.



Many tools always available thanks to the **R16** rear tool changer.

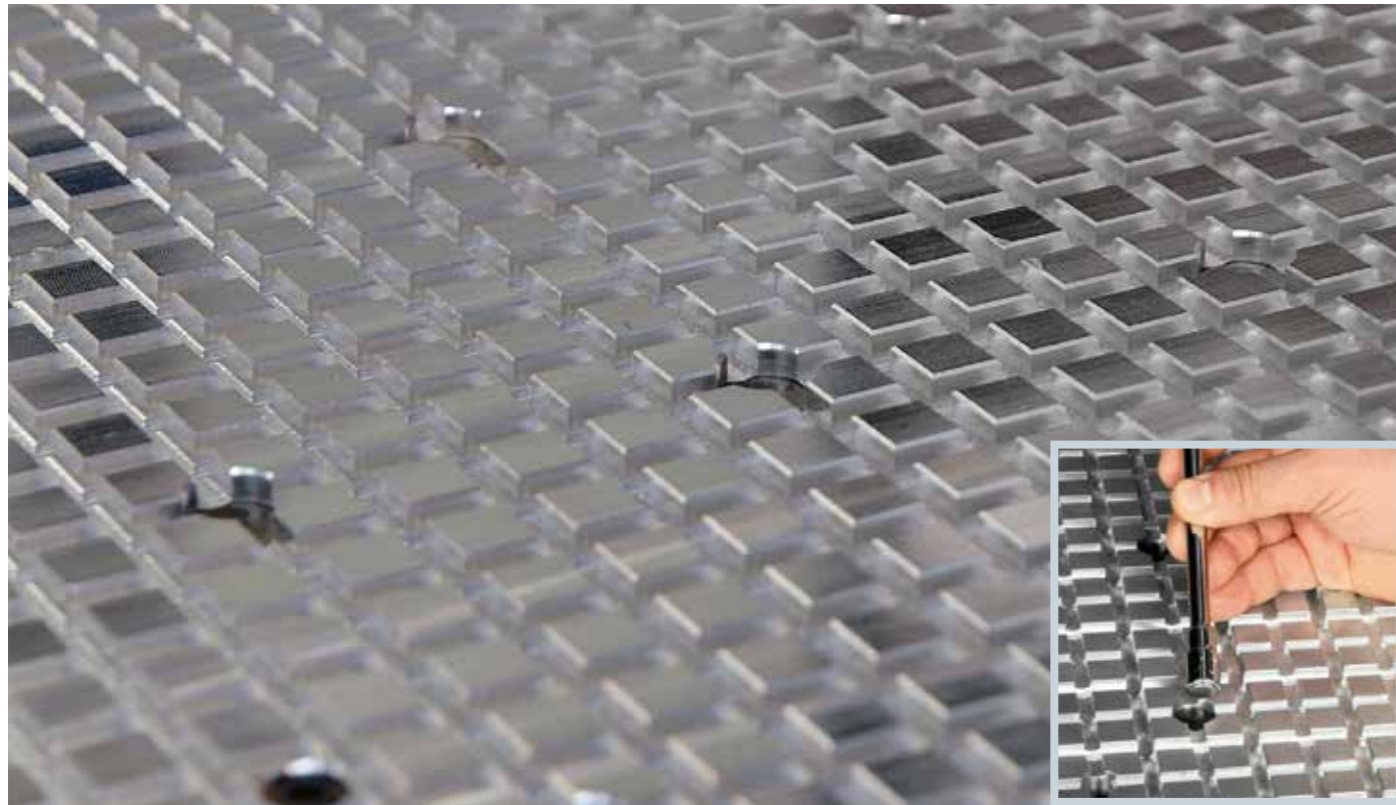

**DESIGNED FOR EFFICIENCY AND SAVING: "HE" (High Efficiency) WORK TABLE**

Sturdy and practical work table, resistant over time thanks to its laminate aluminum structure. Easy and quick setting with the magnetic locking system of the vacuum: in a few seconds the vacuum is activated only in the positioning area of the piece to be machined



Maximum workpieces locking only where needed: starting at 2 increasing up to 30 vacuum zones according to the table size.

**X-VACUUM**

Maximum vacuum holding capacity for processing small workpieces or highly breathable materials.

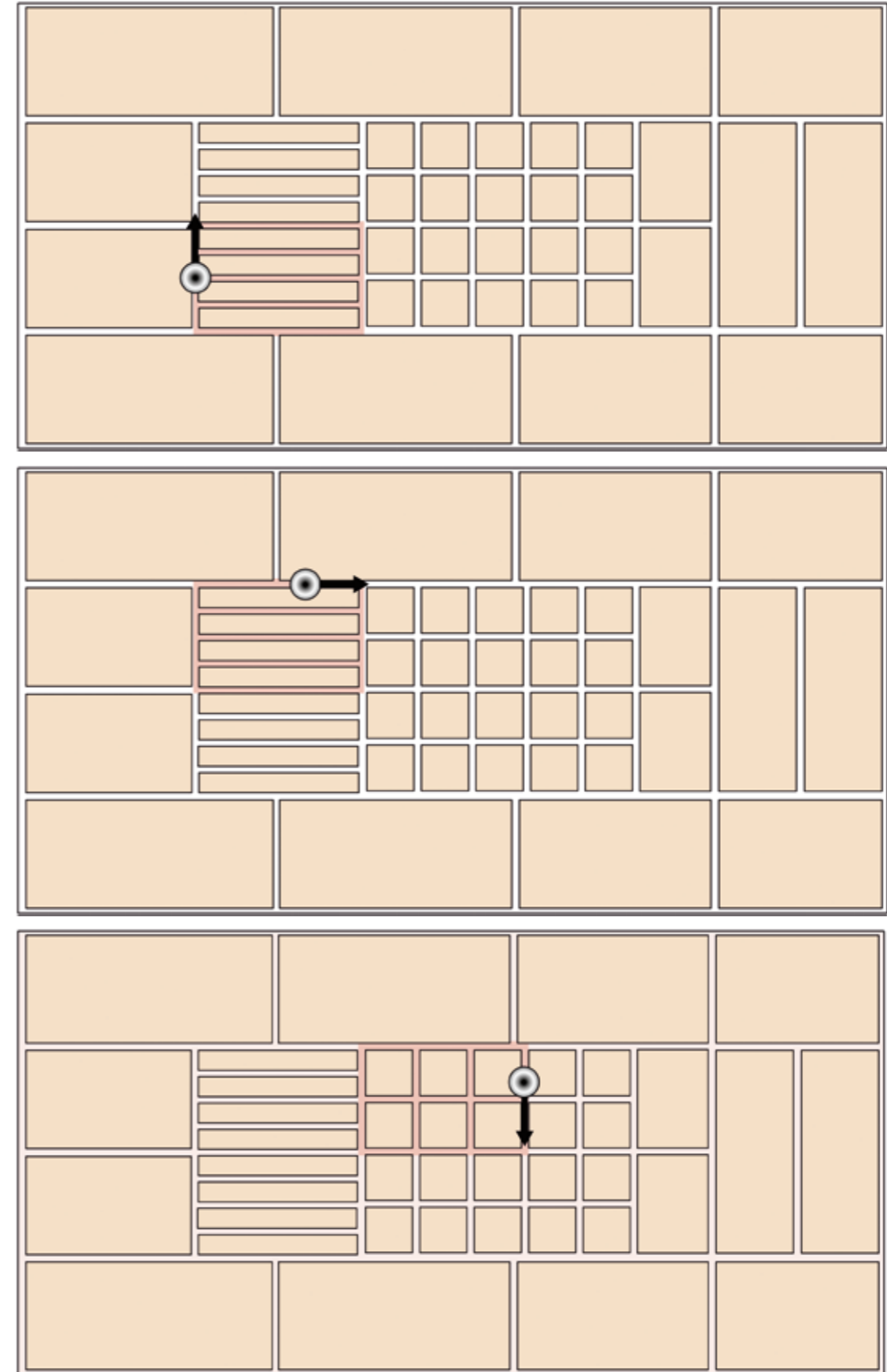

The vacuum is condensed into the area of the worktable where the workpiece is being processed.

# LOADIN AND UNLOADING

**cms tracer 200x/300x**  
CNC machining centers for plastic materials processing

Machine available in nesting cell configuration with loading lifting table and unloading belt (also available with the loading version only or the unloading one) and right and left version

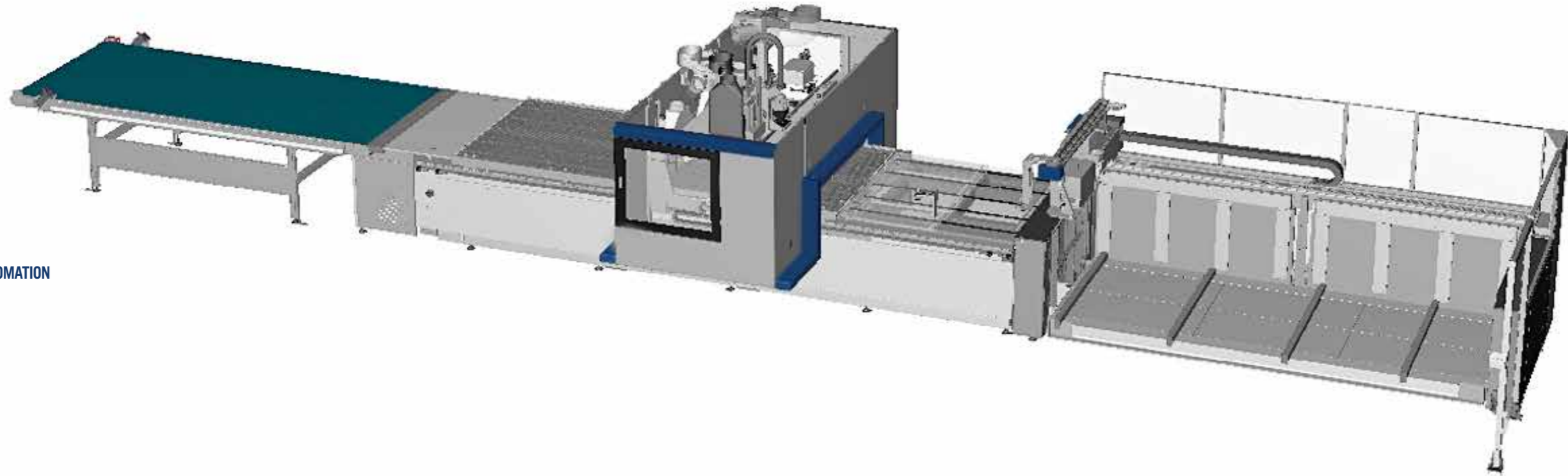

LOADING/UNLOADING AUTOMATION

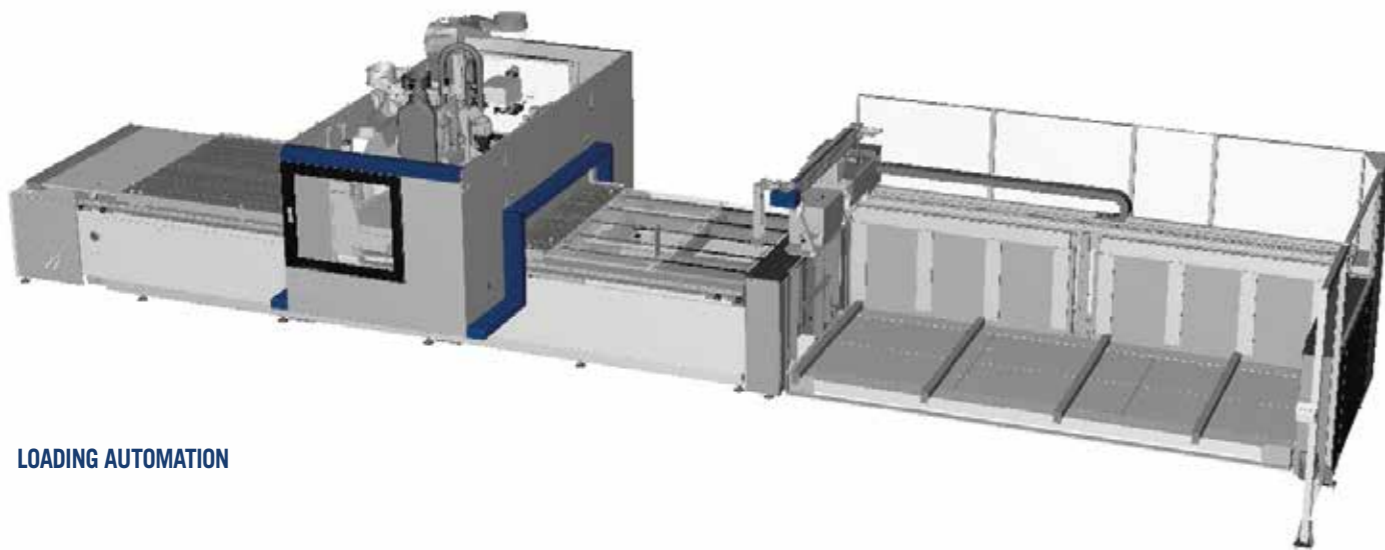

LOADING AUTOMATION

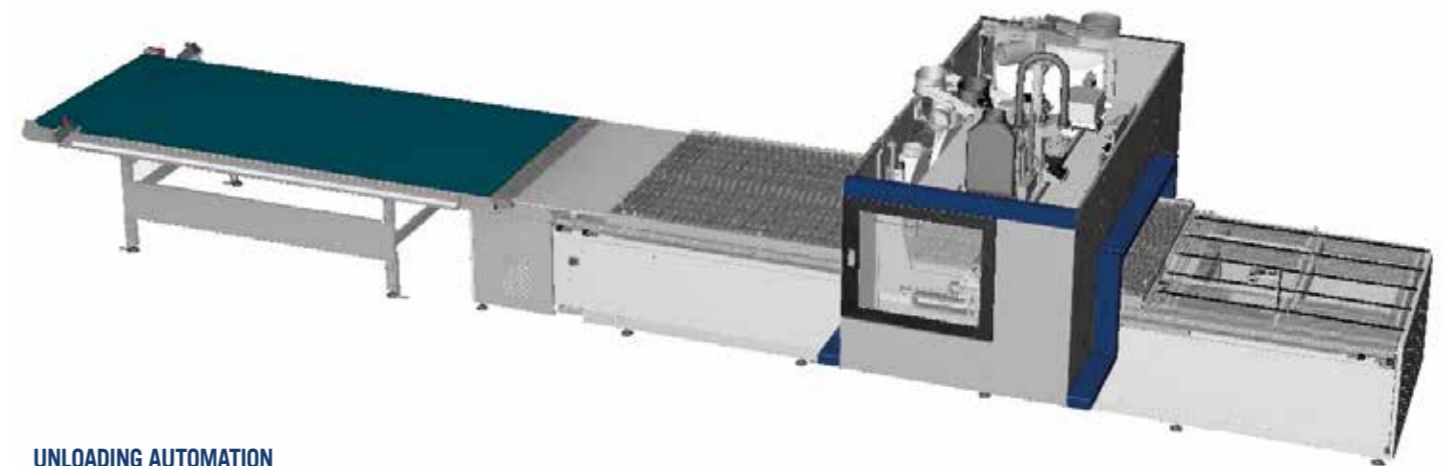

UNLOADING AUTOMATION

# OVERALL DIMENSIONS

\* It includes the operating area

PRO-SPACE		A	B	C
cms 200x/300x 1224	mm	2610/2790	6110/6350	3965/4465
cms 200x/300x 1531	mm	2610/2790	6710/6950	4265/4765
cms 200x/300x 1536	mm	2610/2790	7310/7550	4265/4765
cms 200x/300x 1836	mm	2610/2790	7310/7550	4565/5065
cms 200x/300x 2231	mm	2610/2790	6710/6950	4885/5385
cms 200x/300x 2243	mm	2610/2790	7910/8150	4885/5385

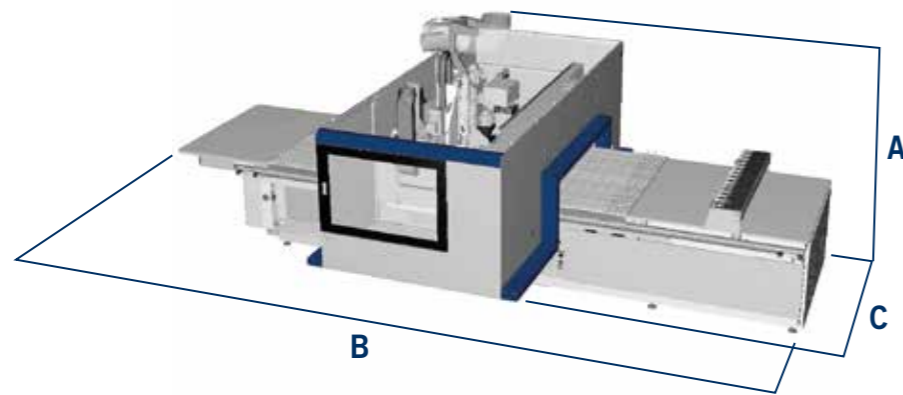

\* It includes the operating area

PRO-SPEED		A	B	C
cms 200x/300x 1224	mm	2610/2790	6570	4190/5060
cms 200x/300x 1531	mm	2610/2790	7170	4490/5360
cms 200x/300x 1536	mm	2610/2790	7770	4490/5360
cms 200x/300x 1836	mm	2610/2790	7770	4790/5660
cms 200x/300x 2231	mm	2610/2790	7170	5110/5980
cms 200x/300x 2243	mm	2610/2790	8370	5110/5980

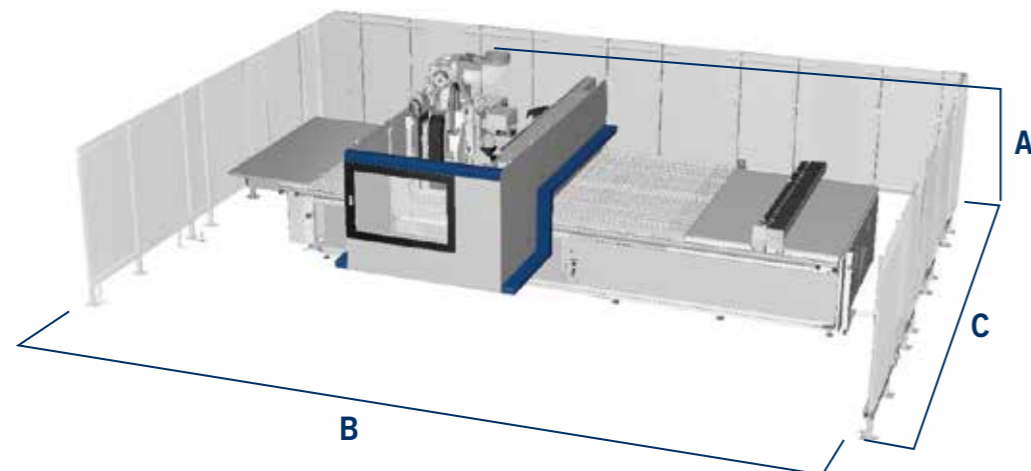

# TECHNICAL DATA

**cms tracer 200x/300x**  
CNC machining centers for plastic materials processing

TRACER		200x	300x
<b>AXES</b>			
Vectorial speed X-Y axes "PRO-SPACE" version	m/min		84
Vectorial speed X-Y axes "PRO-SPEED" version	m/min		113
Z-axis panel passage	mm	150	180
<b>ROUTING UNIT</b>			
Motor power (up to)			
3-4 axis	kW (hp)		15 kW (20,5)
5 axis		-	13,5 (18,4)
Rotation speed (max.)	rpm		2400
Available tools on tool changer (up to)	positions	38	53
<b>DRILLING UNIT</b>			
Vertical spindles (max.)	n.		21
Horizontal spindles (max.)	n.		12
Rotation speed (max.)	rpm		8000
Integrated blade in X, diameter	mm		125
<b>INSTALLATION</b>			
Exhaust air consumption	m <sup>3</sup> /h		4430
Exhaust air speed	m/sec		25
Exhaust outlet diameter	mm		250





## Maestro cnc

In the office, before the production, the design and programming system Maestro cnc ensures that routing, drilling or sawing can quickly and easily be programmed thanks to 3D graphics of work pieces and machining and clamping aids as well as a smart App and macros library to program any machine operation with a mouse click.

Another click away and CNC programs are automatically generated.

### SOFTWARE

#### Office



## Maestro active cnc

Maestro active is our new operator interface software which has been A single operator can easily and confidently run multiple machines due to controller and interface consistency: regardless the machine, Maestro active maintains the same look&feel, with many identical icons and navigation buttons, thus ensuring the same approach to interaction.

### EASE OF USE

The new interface has been specifically designed and optimized for immediate use via touch screen. Graphics have been redesigned for simple and comfortable navigation, with tablet-like icons on touch screen controller.

### "ZERO" ERRORS

Improved productivity thanks to integrated help and recovery procedures that reduce the possibility of error from the operator's side.

### SOFTWARE

#### Factory

## Maestro cnc

### ADDITIONAL FUNCTIONS

## THE SOFTWARE THAT SIMPLIFIES THE WORK

CAD/CAM programming software to design all the production processes. Developed in Windows® environment it ensures easy programming with an advanced, simple and intuitive sketching environment that features all the tools necessary to design the parts, their layout on the work table, tools management and the relative machining operations. All the procedures are contained in a perfectly integrated and high performance software.



### Maestro pro view - Unique in the simulation of 3D objects

3D simulator allows to have in office the three-dimensional model of the machine and to visualize in advance all the machinings that will be done during production.



### Maestro 3d - Unique in the creation of 3D objects

The module integrated in the Maestro suite is designed to program three dimensional objects on 5-axis machining centres.



### Maestro apps - Unique know-how

Maestro apps is a library of programming functions that are always available and easy to use, developed Specifically for plastic materials processing.



### Maestro msl connector - Total integration

Connector for third-parties with design software.

## Maestro active cnc

## AN INNOVATIVE INTERACTION WITH YOUR CMS MACHINE FOR PLASTIC MATERIALS PROCESSING

### FULL CONTROL OF PRODUCTION PERFORMANCES

The creation of customizable reports by operator, shift, program, forecast period (and much more) allowsto monitor, optimize and improve the production performance.

### FULL MACHINE AWARENESS AND KNOWLEDGE MANAGEMENT SYSTEM

Maestro active allows to record the times related to setup, maintenance, training and other events, tracing all the activities in a database. The operator's know-how is also stored and made available to other people inside the organization thanks to the possibility to comment and document all production events or notifications.

### ORGANIZE YOUR PRODUCTION

Maestro active allows to create different users with different roles and authorizations (e.g.: operator, maintainer, administrator, ...). Any user can only execute the functions whose permissions have been assigned to him. It is also possible to define the work shifts on the machine and then detect activities, productivity and events that occurred in each shift.

### TOTAL QUALITY OF THE FINISHED PRODUCT

With Maestro active the quality of the finished piece is no longer put at risk by worn tools. The new Maestro Active Tool Life Determination system sends notification messages as the tool reaches its end of life and recommends its replacement at the most appropriate time.

### TOOLS? NO PROBLEM!

Maestro active guides the operator during the magazine tooling phase, taking into account the programs to be executed.

# THE RANGE OF CMS PLASTIC TECHNOLOGY

# FOR PLASTIC PROCESSING

## 3/4-AXIS CNC MACHINING CENTERS



TRACER



TIME



EVOTECH

## BEAM SAWS



HELIX

## BAND SAWS



T-MAXI

## 5 AXIS CNC MACHINING CENTERS



ATHENA



ANTARES



ARES



MX5

## THERMOFORMING MACHINES



BR5



BR5 CS

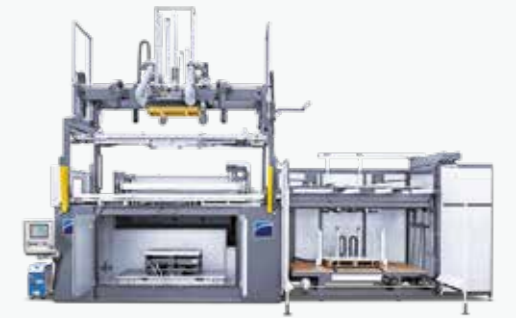

BR5 S



BR5 HP



BR5 SPECIAL SPA



MASTERFORM



**C.M.S. SPA**  
via A. Locatelli, 123 - 24019 Zogno (BG) - IT  
Tel. +39 0345 64111  
[info@cms.it](mailto:info@cms.it)  
[cms.it](http://cms.it)

a company of **scm**group