

# COSTA Levigatrici

# PARQUET machines



 **COSTA**  
LEVIGATRICI

# Calibrating-sanding lines

- **SEMI-AUTOMATIC CALIBRATING LINE for CORE MATERIAL (plywood) complete with loading-stacking platforms)**

Working Width	1650 mm
Working Speed	30 m/min
Installed Power	270 kW

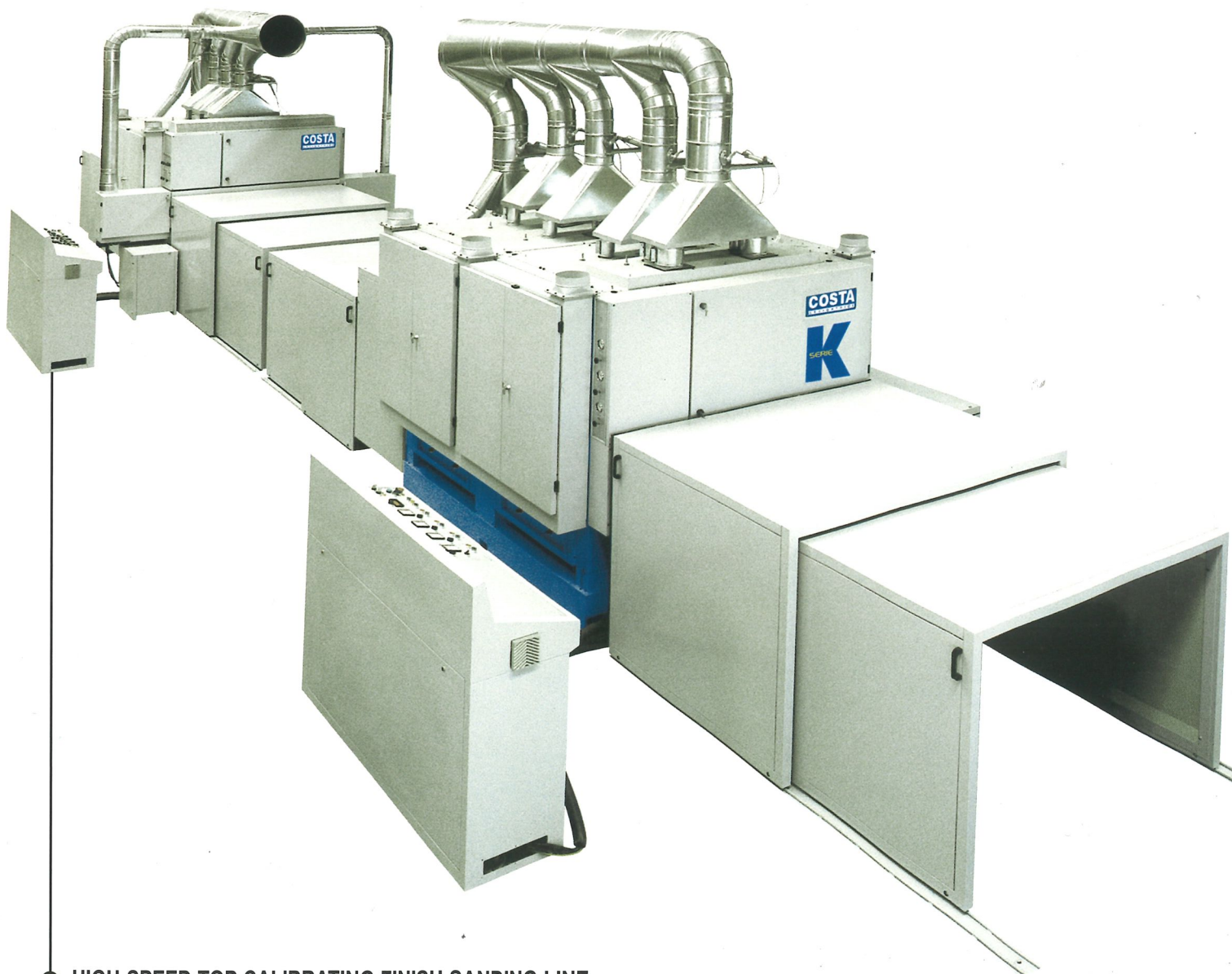

- **HIGH-SPEED TOP CALIBRATING FINISH SANDING LINE**

with full sound protections to 75dB , air return system, automatic re-setting control to hold thickness tolerance on work pieces.

**CALIBRATING machines**  
for the accurate preparation of layers (prior to pressing)

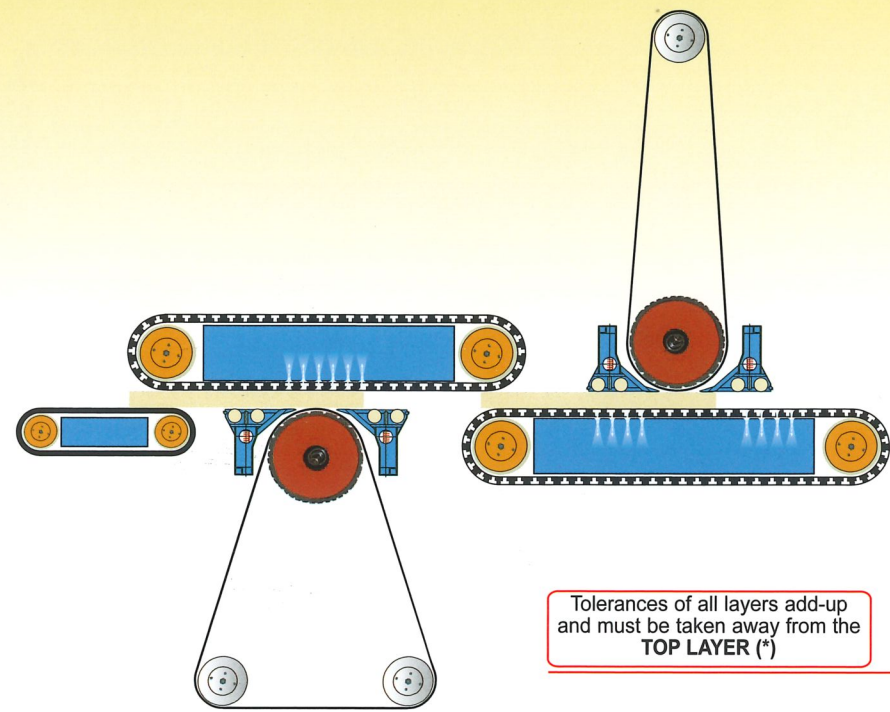

**WHY CALIBRATING THE INDIVIDUAL LAYERS ?**

- to avoid taking away the exceeding thickness tolerances of the internal layers from the top layer.
- to have a more stable plank with layers with normalized thickness.
- to have a better utilization of the press, with more even pressure on the work-pieces when pressing.

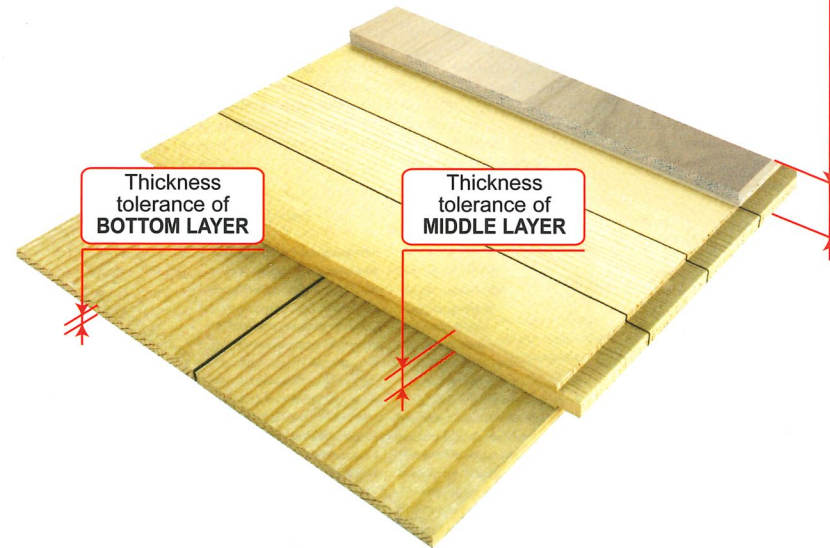

**CALIBRATING machines** utilized in the PARQUET flooring working cycle either in a stand alone or in first position of the finishing line to dimension the thickness of the planks

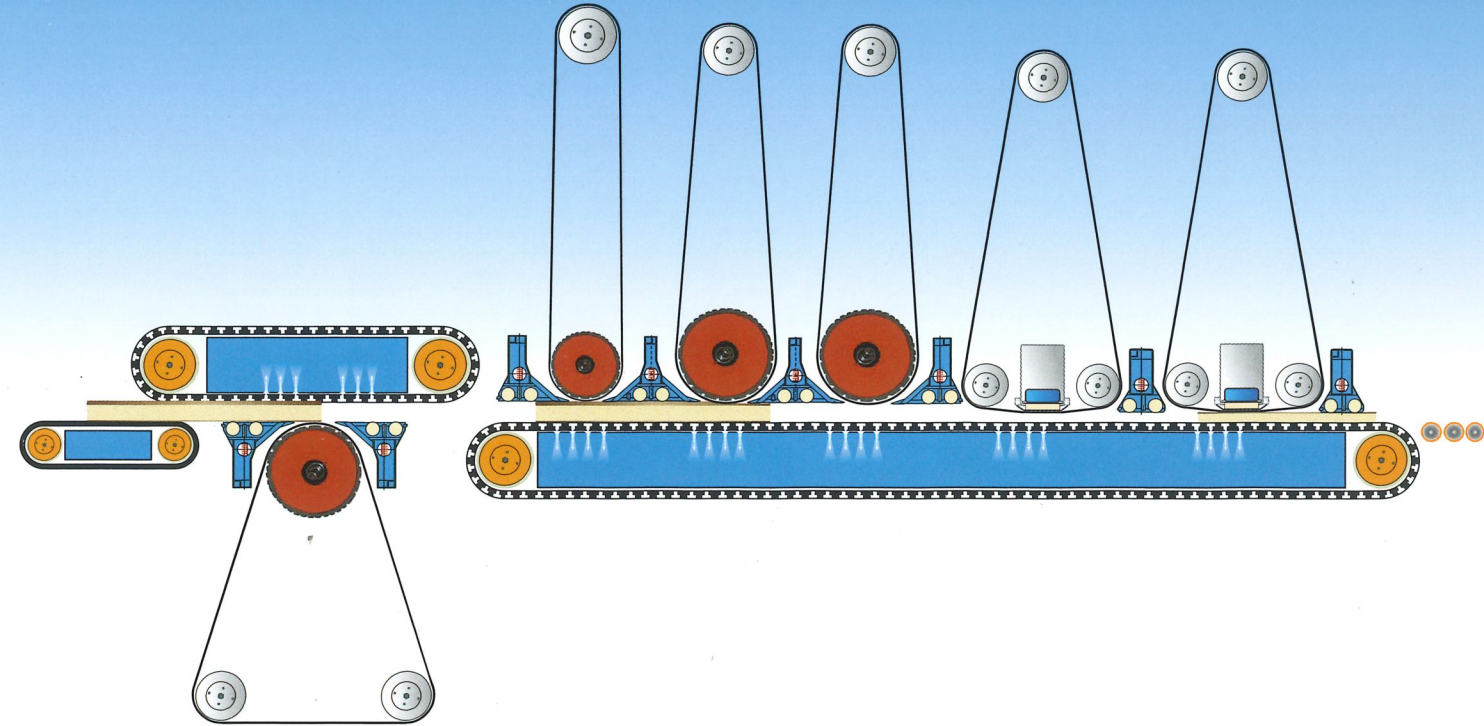

After pressing, the planks must be calibrated-sanded to "perfection" prior to lacquer finishing. This calibrating-white-wood sanding operation is normally performed in the first position of the finishing line. A first bottom machine can be useful to level the back side of the planks, to reduce the take away from the top layer, (\*) due to tolerances adding up from other layers. On the top side the surface finish requirement is determining the number of working units, up to 6 units on top side and 4 in bottom side, depending on feed speed and take away needed. The power of the working units is in relation to the amount of take-away, the sanding belt grit utilized, to the feed speed of the line.

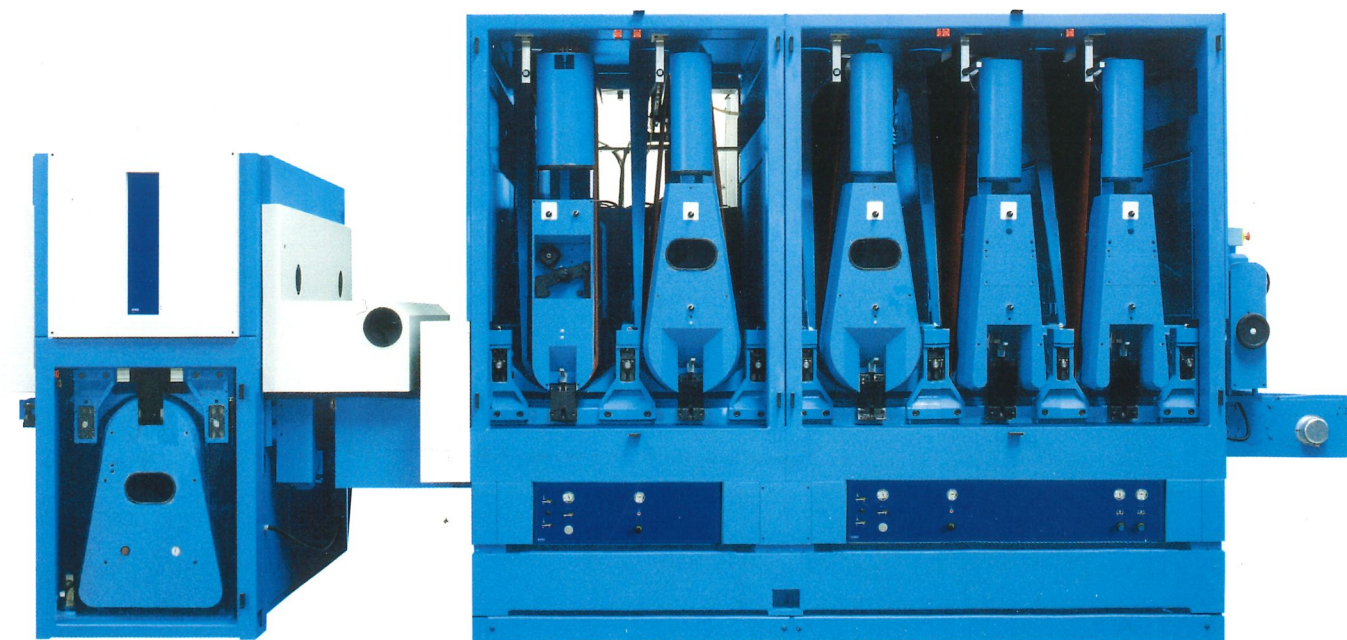
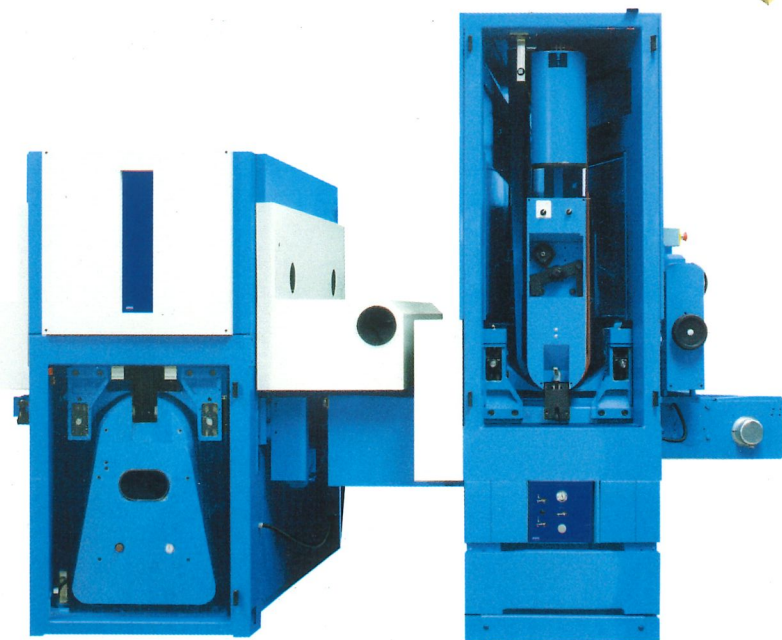

**GRAIN HIGH-LIGHTING machine**  
to brush the grain with steel-anderlon brushes

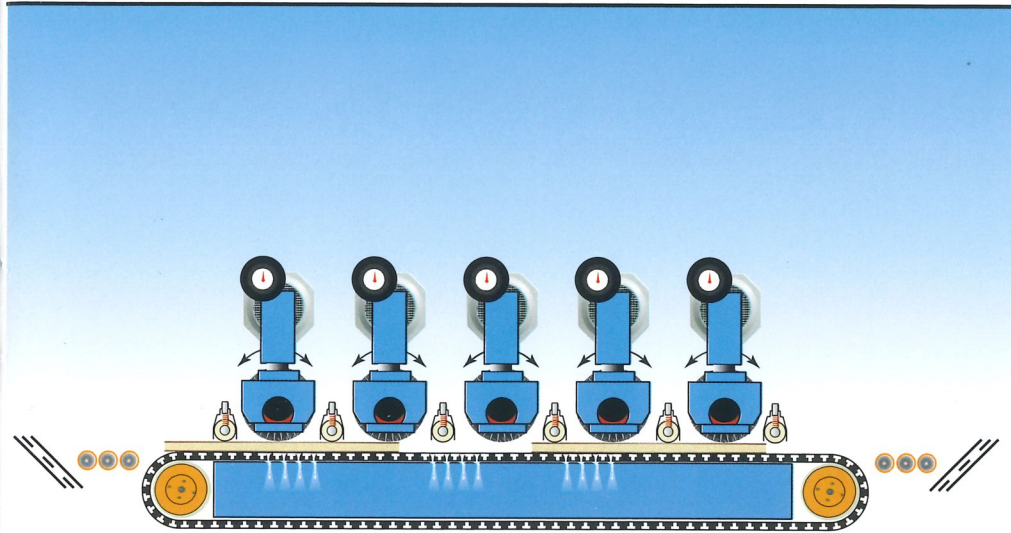

GRAIN HIGH-LIGHTING machine is utilized in the flooring working cycle to brush the grain (more or less deeply) with steel-tyrex/anderlon brushes. This machine is normally positioned right after the calibrating machine. The brushes need to be two for each type in use, each with the inversion of rotation in order to compensate the consumption of the brushes, and in order to have the same finish all around the knots and in the start-end of the grain (when with only 1 brush the finish is different in the grain directions and around the knots). We normally recommend 2 steel brushes, followed by 2 tyrex/anderlon units and a final vegetal cleaning brush, with rotary blowers in the end of the process to clean perfectly the work-pieces prior to further finishing operations. Our machine is completely enclosed to avoid the dispersion of dust in the working area.

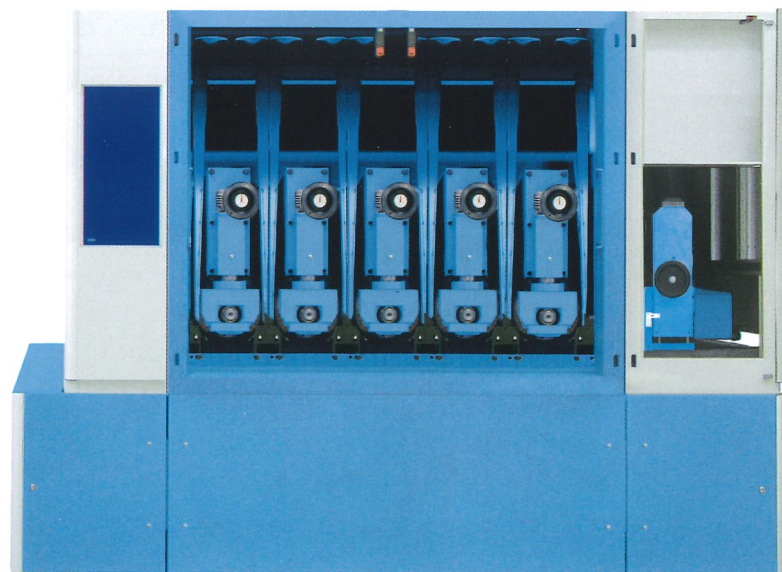

**FILLER SANDING machine**  
to level the filler applied

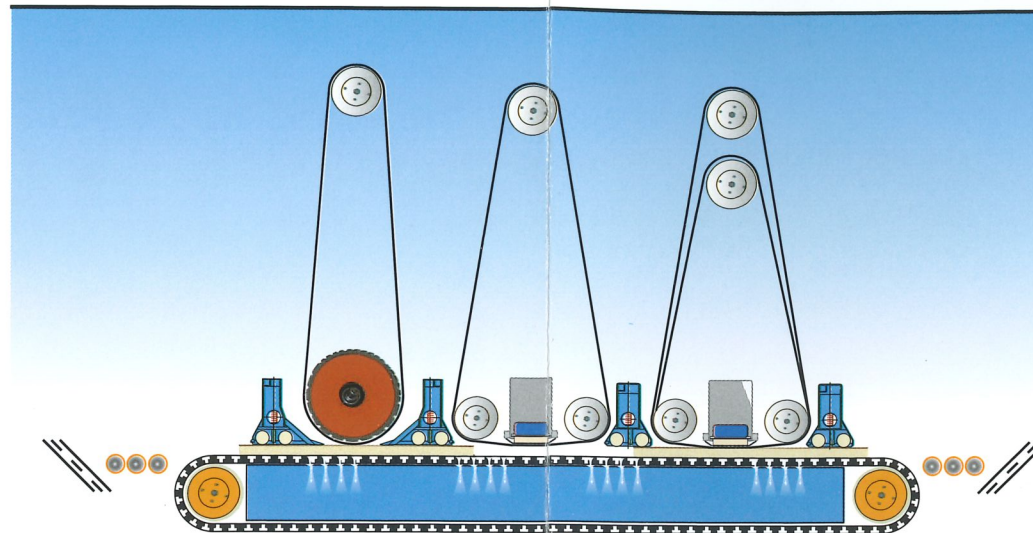

FILLER SANDING machine is utilized in the flooring working cycle to level the filler applied to close the gaps between the top strips on the surface. The machine is equipped with one cylinder and one or two pad units depending on the surface finish requirement. The cylinder is recommended for the higher take away capacity of this unit (compare to pads) together with the easier-better cleaning possibility of the sanding belt grit to prevent clogging.

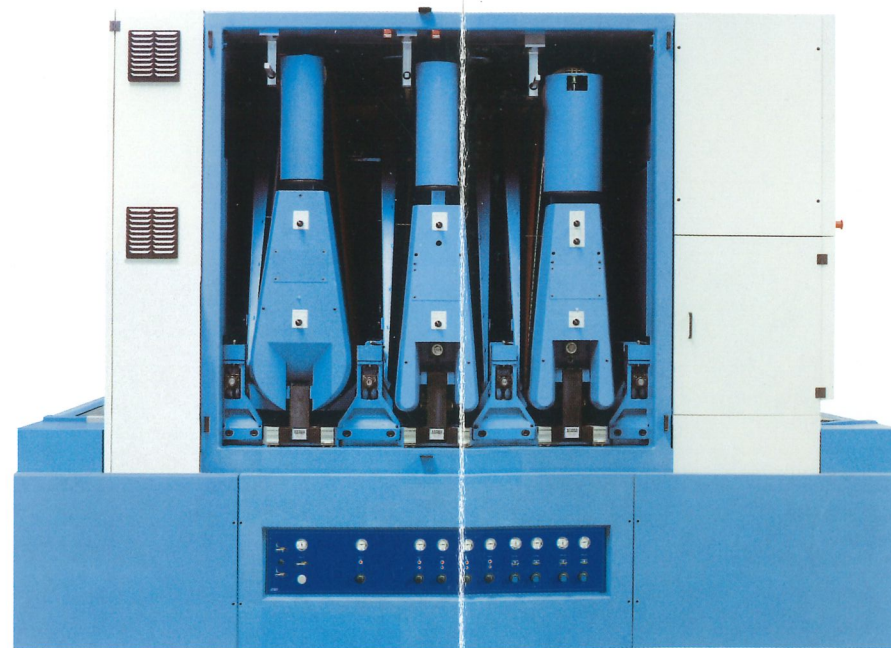

**LACQUER SANDING machine**  
utilized in the PARQUET flooring working cycle

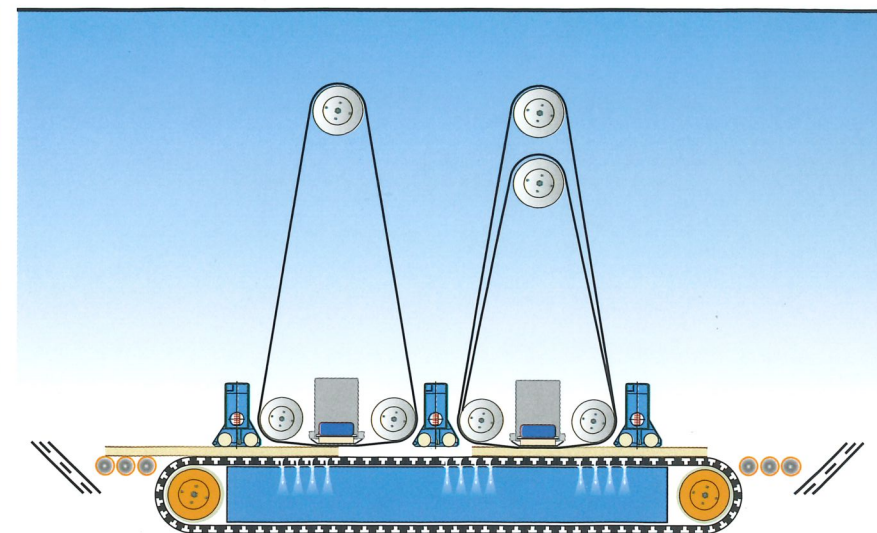

LACQUER SANDING machine utilized in the PARQUET flooring working cycle to level the lacquer applied on the surface. The machine is equipped with one or two pad units depending on the surface finish requirement. The length of the sanding belt is very important for the longer lasting time and therefore for diminishing the down time needed for the change when the belts are clogged. The final sanding belt grit sequence utilized ranges from 280-320 to 360-400.

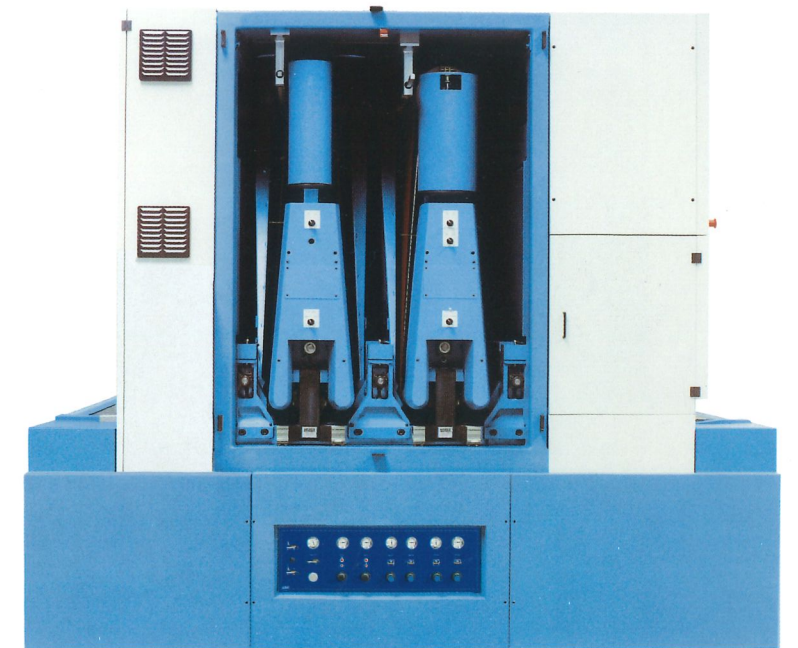

### Feed table

The heavy calibrating machines require an absolutely rigid feed table of reference to assure the accuracy of the work-pieces in the calibrating process.

Our feed tables are build in thick solid steel sheets type T1 (hardness up to 400 Brinell), grinded to a very fine level of rugosity, for an accuracy of surface flatness of mm +/- 0,025.

**Interchangeable inserts in hardened or ceramized steel** (optional), positioned under the working units; recommended to prevent excessive wear in heavy-duty operations and in high speed machines;

additional option is the water cooling system running in the inserts ( complete with heath exchanger ) to hold precision.

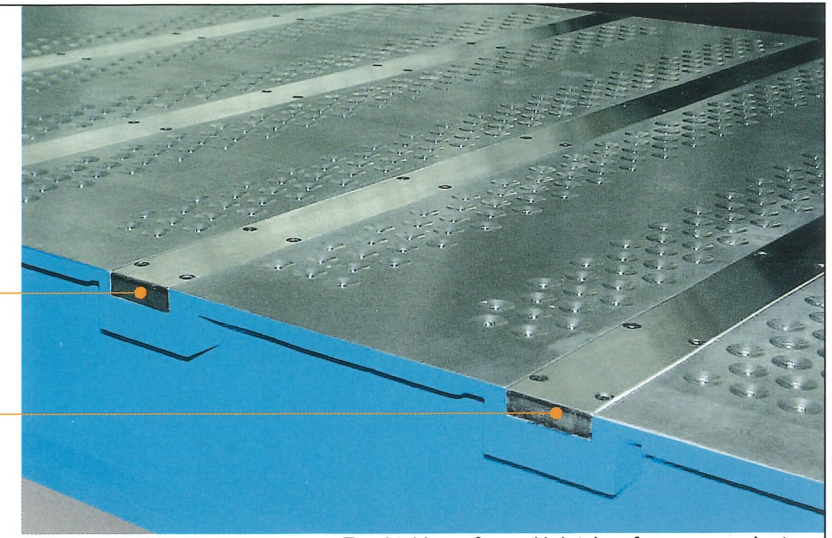

Feed table surface with intakes for vacuum plant

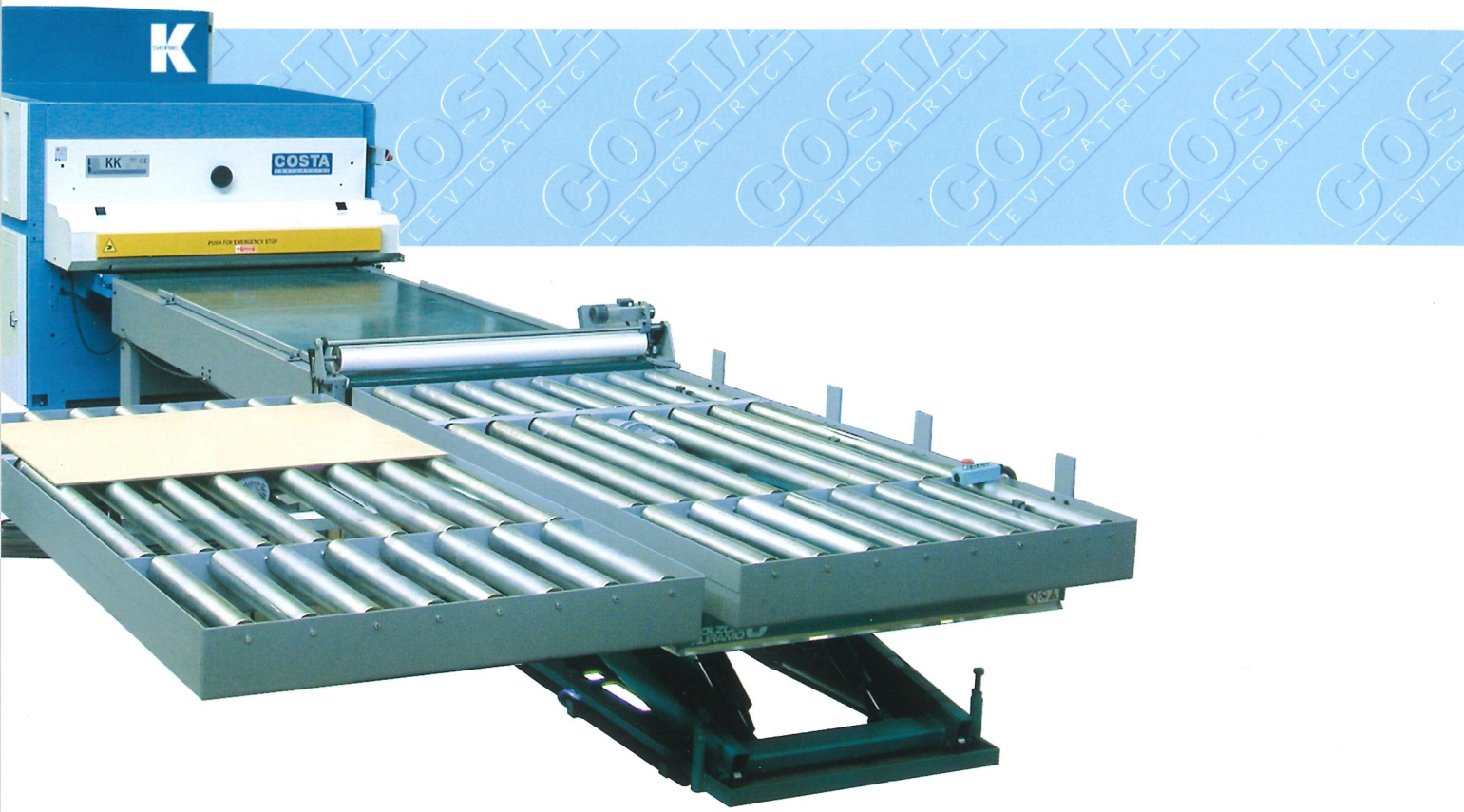

### 6 units CALIBRATING MACHINE 1st position in high-speed finishing line

This machine is equipped with a special sound-proofed AIR-RECOVERY system to recycle the air coming from the dust filter back inside the machine, up-to the 70% of the volume extracted. The machine and air return are equipped with sound protections to 75 dB.



### Frame + lifting system

The top frames of our calibrating machines are very rigid to maintain tight thickness tolerances; we utilize 1 separate frame for the first 2 working units followed by another independent frame with the remaining finishing heads.

In this way we utilize a set of two supporting columns for each main working unit.

Each frame is lifted with independent lifting/supporting columns.



In the same base it is positioned also the feed table, totally extractable for the (eventual) change of the feed belt.

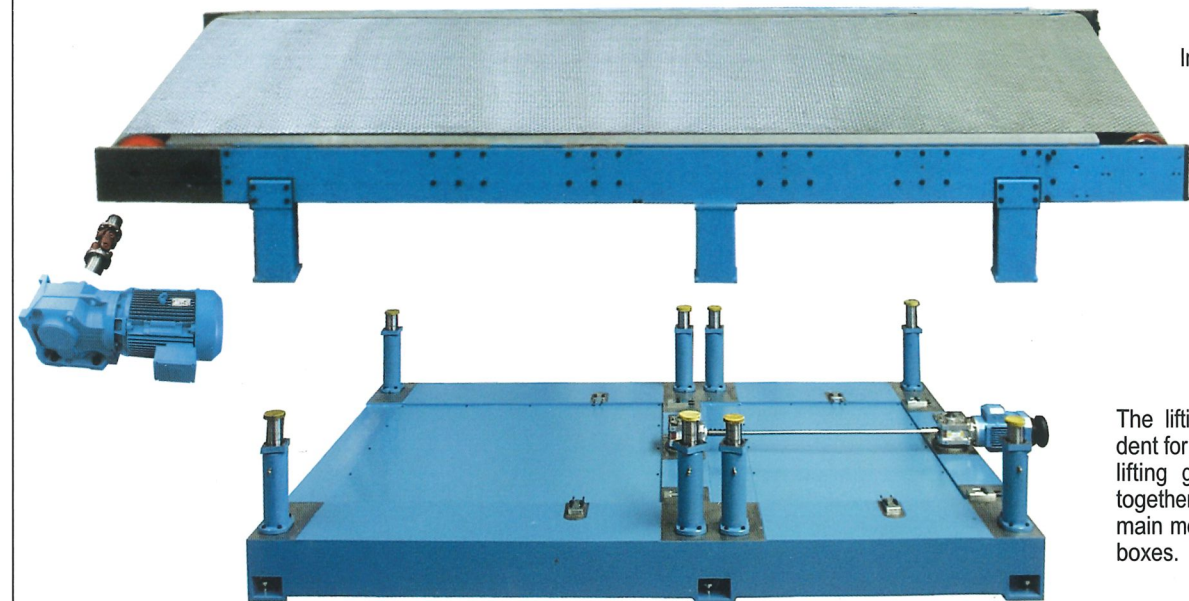

The lifting system is independent for each top frame; the two lifting gear boxes are linked together by a solid shaft; one main motor is driving both gear boxes.

**Pressure unit (top view)**

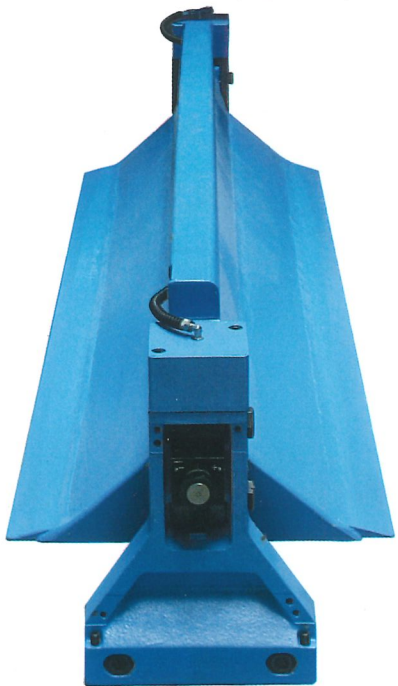

Heavy-duty pressure units with chromium coated or ceramic treated "lips". These units are mounted on slides with centralized pneumatic pressure adjustment. The central part of the pressure units is complete with rubber covered pressure rollers in 2 halves, adjustable with excentric setting.

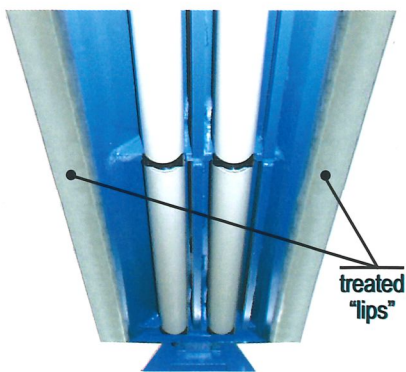

**Pressure unit (bottom view)**

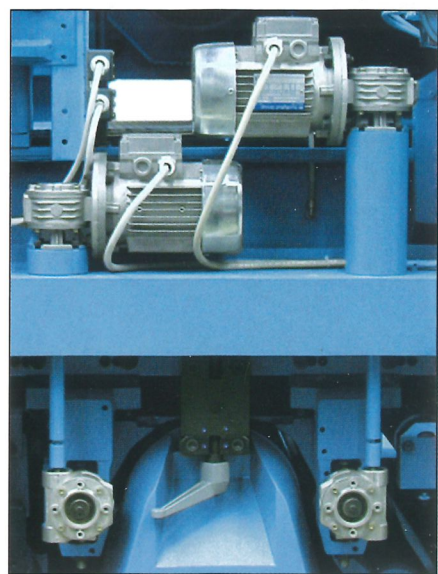
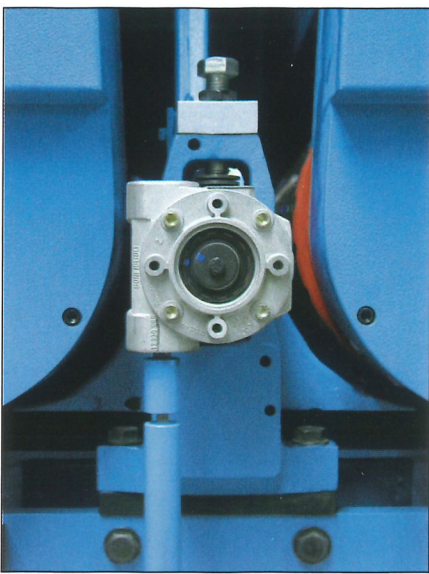

**Automatic setting of pressure shoes**, with control of position from PC, to follow the re-positioning of the cylinder working units (opt.). This option requires PC and is best utilized in conjunction with Costa Calibrating Manager.

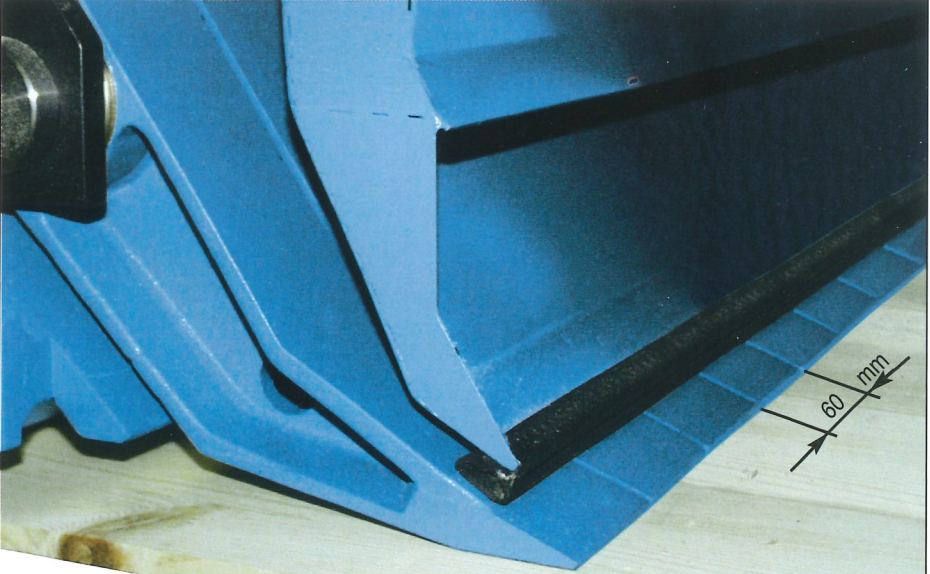

**Infeed sectioned pressure unit + dust hood intake**

First infeed sectioned pressure shoes with lips, pitch of sections 60 mm, with independent pneumatic pressure to assure the appropriate load to streighten warped material (opt.).

**Infeed driven pressure-safety roller**



Heavy driven infeed pressure roller, rubber covered, to flatten warped work-pieces, complete with emergency-safety system to prevent overlapped loading (opt.).

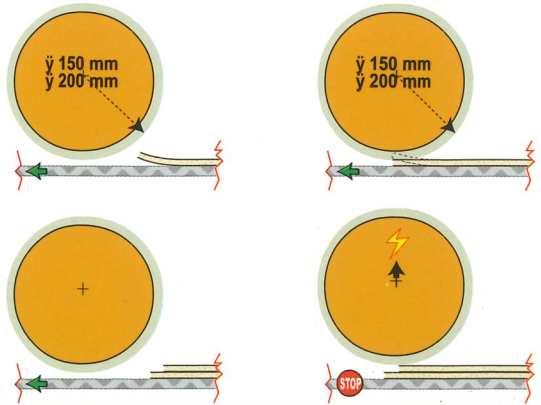

# Important features of our parquet flooring machines : WORKING units

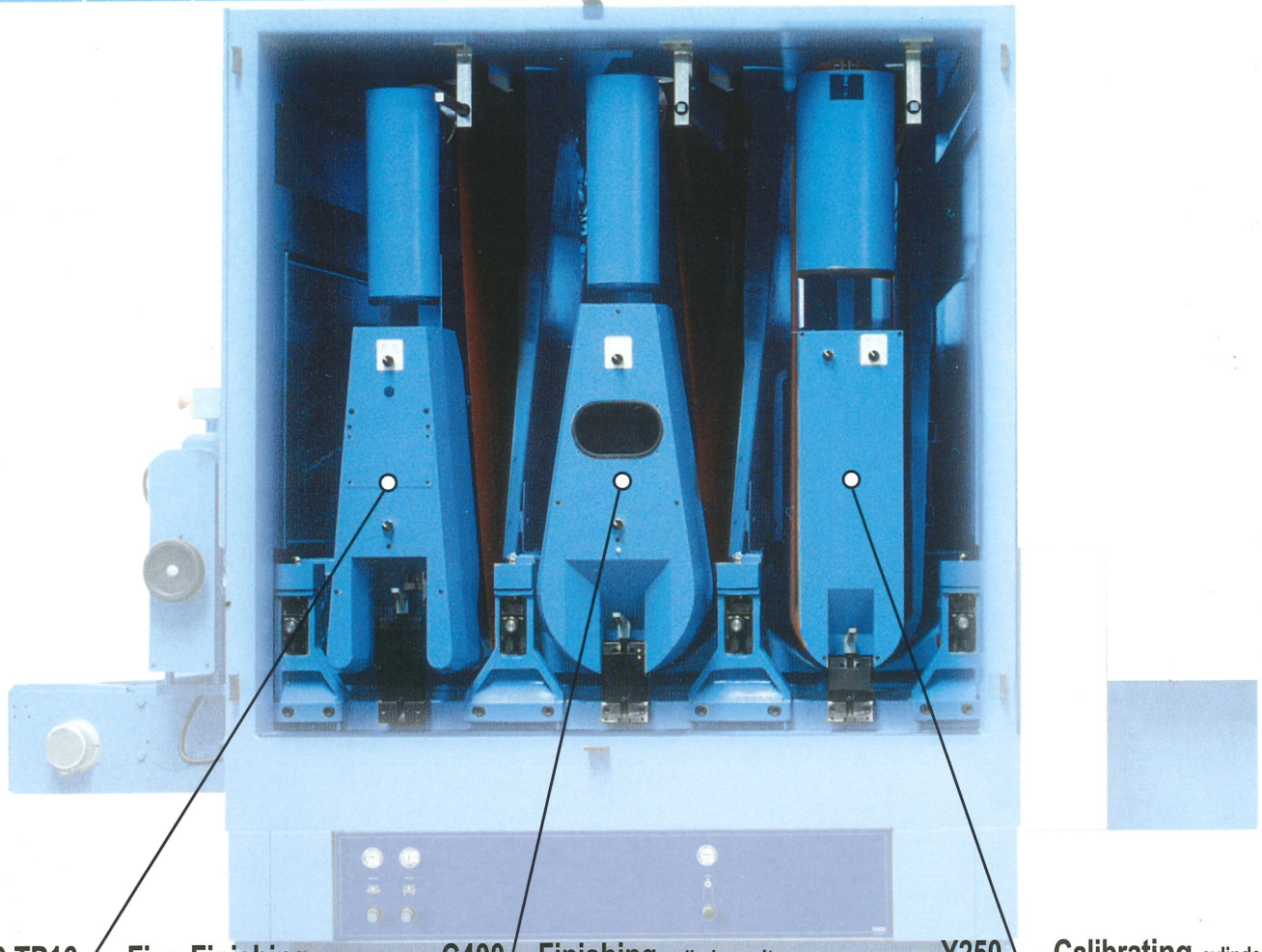

**TP32 TP16** - Fine Finishing  
electronic controlled sectioned pad unit

**C400** - Finishing cylinder unit

**Y250** - Calibrating cylinder unit

This is the sanding unit for finishing the surface; it can compensate eventual thickness and planarity differences of the work-pieces. The sanding belt is pressed down to the surface of work-pieces by a number of contact elements, at variable intensity of pressure. The wide surface of contact of the pad unit gives a flat look to the surface. For an ideal protection of edges and corners of panels we recommend the sectioned pads with electronic control of the timing and of the pressures of intervention of each individual pad segment.

The rubber hardness determines the level of adaptation of the cylinder working pressure on the panel surface;

a soft rubber cylinder has more adaptability to the unevenness of the surface and is recommended for fine sanding grits;

a hard rubber cylinder has less or no adaptability to the surface, therefore it is better for calibrating operation;

Heavy-duty working unit with cylinder  $\varnothing$  mm 250, foreseen for heavy utilization.

Y250 is equipped with:

- special bearings for high speed and greasing for life;
- high speed tension roller.

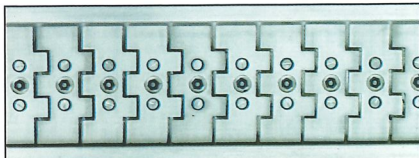

- pitch of sections 32 mm
- n° 42 sections with a working width of 1350 mm
- n° 52 sections with a working width of 1650 mm

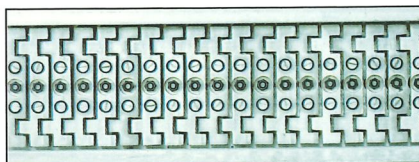

- pitch of sections 16 mm
- n° 84 sections with a working width of 1350 mm
- n° 104 sections with a working width of 1650 mm

tension roller

steel surface or rubber covered cylinders

Pneumatic operated disk brakes to stop the working units within few seconds from emergency.

motor of the working unit

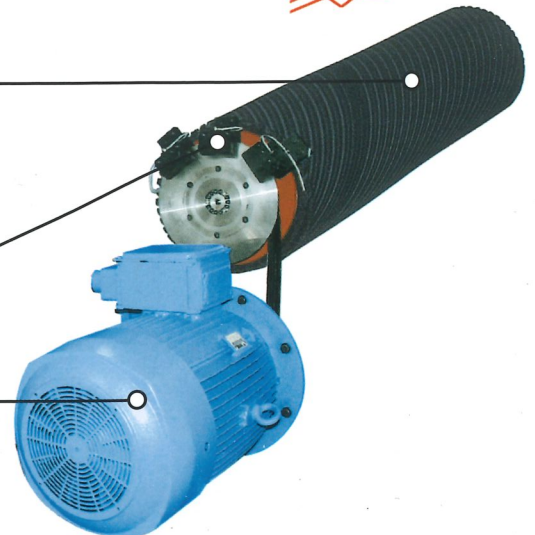

# Important features of our parquet flooring machines : THICKNESS measuring system

# Electric/Electronic Controls and Line Connections

## LT2 - "Laser thickness control of the processed work-pieces"

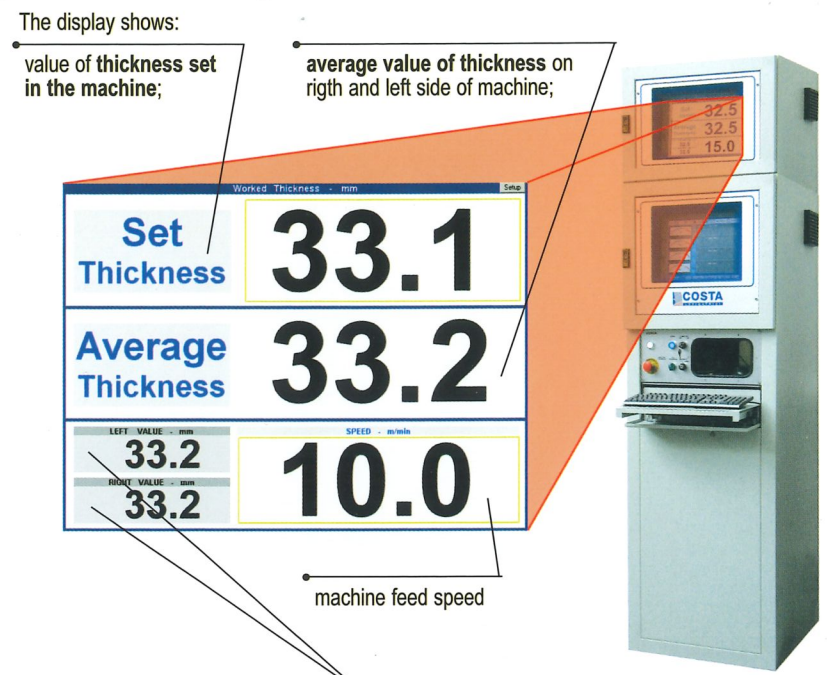
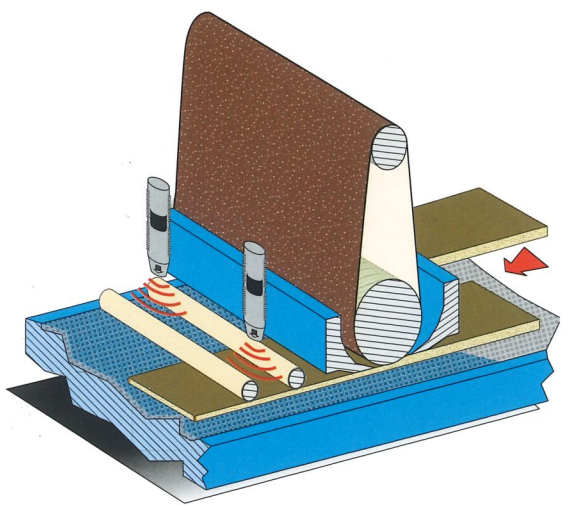

The display shows:  
 value of thickness set in the machine;  
 average value of thickness on right and left side of machine;

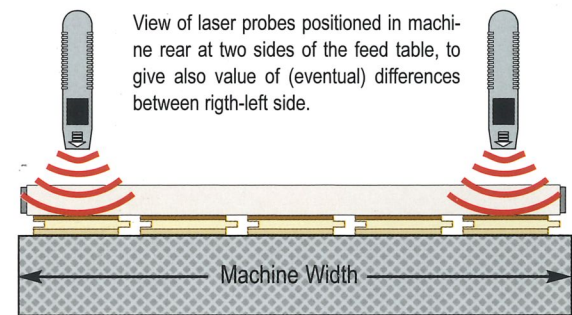

Actual thickness value measured by each laser probe

The continuous monitoring of the thickness of processed work-pieces and the correction of thickness tolerances caused either by thermal excursion of working units and / or by the wear of the sanding belts, avoid rejects of entire batches of material.

The laser probes show the thickness value of work-pieces on right and left side in real time, and calculates the average between the two sizes.

The difference between the thickness set in the machine and the average of the thickness coming out, corresponds to the correction that should be made to reset the machine thickness, either in automatic ( with PC3 ) or manually by the operator.

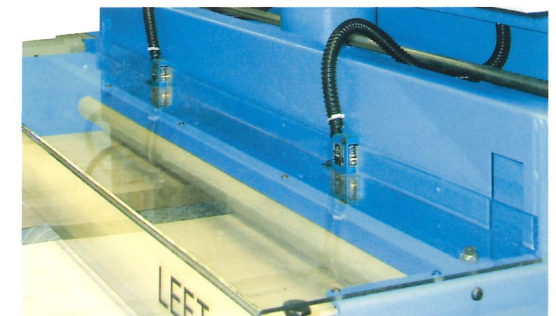

Thickness taken by 2 laser probes, positioned between two pressure rollers (to assure an absolute adherence of work-pieces to the feed table, to avoid reading false figures due to warped pieces).

Optional display set in machine rear side



## PC3 - Computer control with interconnecting possibilities

Computer controlled machine, with monitor and keyboard positioned in a separate column

This is a PC working position that can be fully integrated in the company network. The PC control system allows to pre-set all the working programs; in addition to the total control of the machine, can also give complete production data (\*) such: number of pieces processed, working time per each code, square meter produced, compressed air, volume of dust extraction, electric power consumption, etc..

Through a modem we have the possibility to connect directly Costa Service for help and service.

(\*) note: - this connectivity to company networks usually require a specific program of communication.

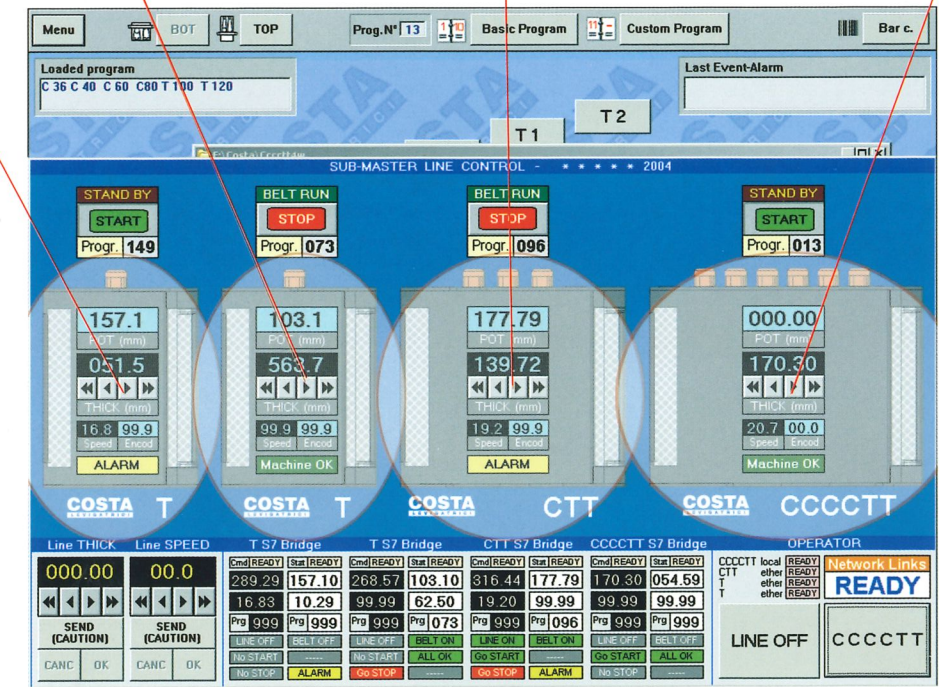
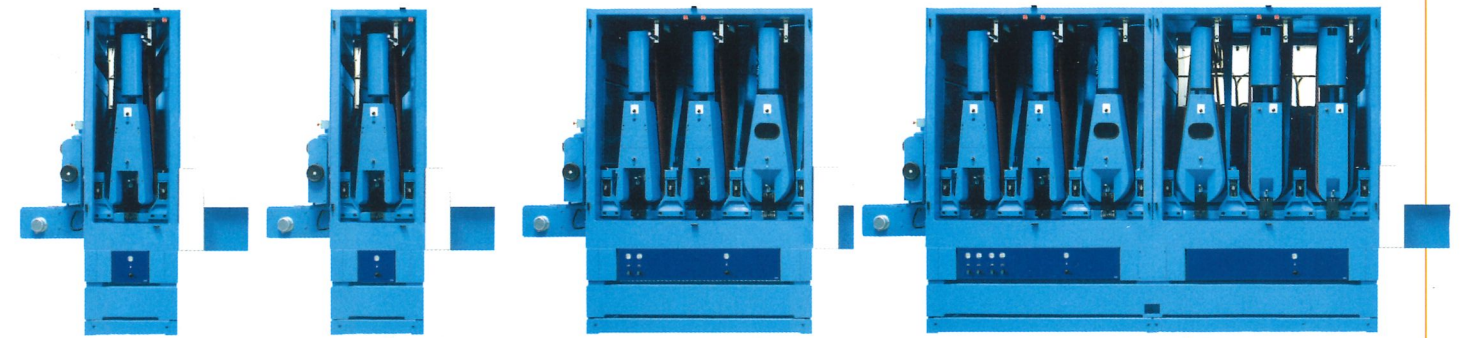
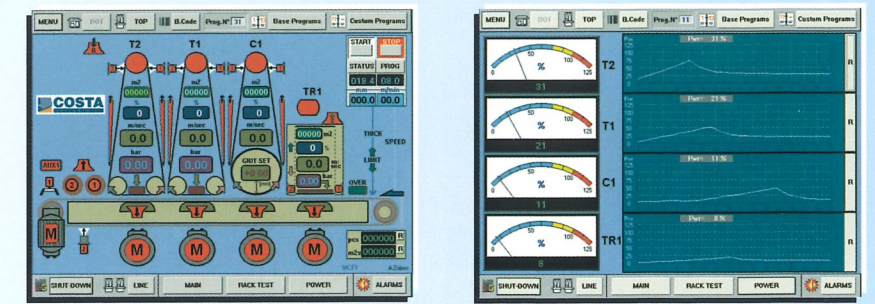

**COSTA LINE MANAGER** is the program that is overlooking the passage of data between the different machines in a working line, to allow the control and the change to new working data, by recalling the code number of the work-pieces. One PC "Line Master" is controlling all machines (or sections of line) with specific program and instructions. "Service Manager" is operated directly by Costa Levigatrici Service connected via modem with the PCs of the machines installed.



# Costa Calibrating Manager - PC Program

Program for setting the machine for calibrating operations with the option/choice to obtain:

A - the highest feed speed

B - the lowest power/belts consumption

in all cases maintaining the given thickness tolerance.

The Operator must input the following data in the PC :

- Type of material
- Width of work pieces
- Average or maximum take away
- Sanding belt grit sequence
- Feed speed required

Unit	Belt Grit	Belt Speed [m/s]	Diameter [mm]	Motor [kW]	Removal [mm]	man Utilization [%]	Power [%]	Life [m2]
C1T	40	36	250	75	0,38	99	00.0	000
C2T	60	30	250	55	0,15	52	00.0	000
C3T	80	25	400	45	0,08	42	00.0	000
C4T	100	20	400	37	0,06	45	00.0	000
T5T	120	18	T	22	0,03	33	00.0	000

The program is requiring a "dialog" with the Operator based on the fix machine parameters such: number of working units to utilize, power available, sanding belt grit sequence, feed speed , percentage of sanding belt utilization recommended.

The Operator can insert variable of take away, of feed speed, of sanding belt grit sequence, up to an acceptable definition of the final data of each working unit. The figures obtained can be transferred to the machine, -with a code number- that will be stored in the PC and can therefore be repeated at any time.

The main panel displays three working units (C3, C2, C1) with the following parameters:

- Power Load:** C1 000.0%, B1 000.0%, B2 000.0%
- Power Management:** Pwr C1 035, Pwr C2 035, Pwr C3 035
- Unit Settings:** Each unit shows m2, m/sec, and GRIT-SET (+0.00 [mm]).
- Control Panel:** Includes 'START', 'STOP', 'STATUS', 'PROG', 'THICK', 'SPEED', 'LIMIT', 'OVER', 'SHUT-DOWN', 'LINE', 'MAIN', 'RACK TEST', 'POWER', and 'ALARMS' buttons.

The second window of the program is showing the Main Panel and the electronic grit system (that are needed for the utilization of this program). Once the Operator has confirmed the sanding belt grit sequence for each working unit, the programme will set the depth of cut of each working unit . The Power Management window monitors the consumption in watt of each working unit. The programme maintains the balance between the motor power of the working units, with the same difference set in the initial program between the working units.



# Combined bottom + top calibrating - sanding machines

Series KK are our "heavy-duty" machines, with possibility to install high-power motors for high feed speed of production.

- centralized thickness adjustment with electronic programmer with 50 programmes;
- centralized feed speed adjustment from control panel of first machine;
- abrasive belt length 2620 / 3250 (top machine only) mm;
- working width 1350-1650 mm;
- thickness workable 0 - 160 mm.



View of the heavy-duty drive unit linked with a cardan joint to the traction roller of the feed belt in a top calibrating machine

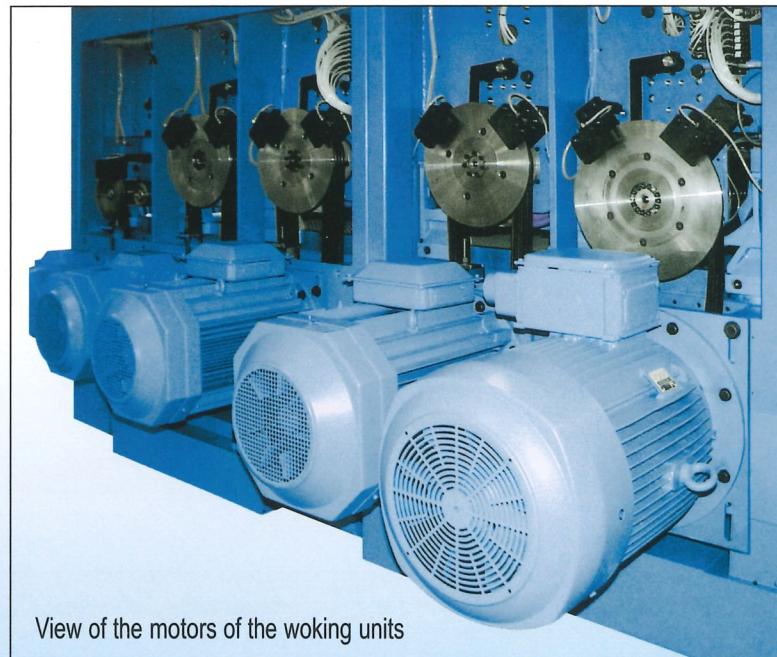
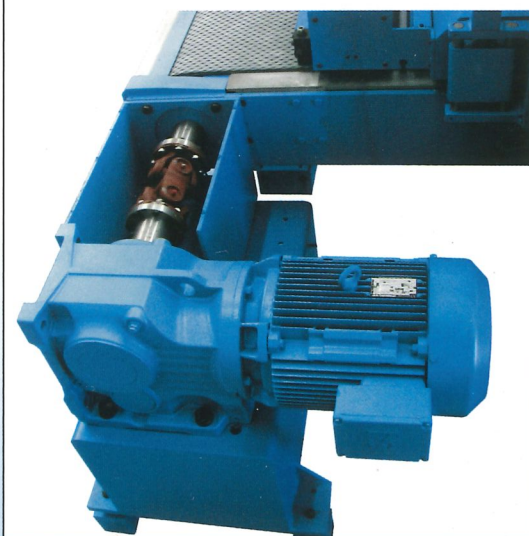

View of the motors of the woking units



# Bottom calibrating - sanding machines

- available with 1 up to 4 working units;
- constant pass-line from floor;
- abrasive belt length 2620 mm;
- working width 1350 - 1650 mm;
- thickness workable 0 ÷ 160 mm.

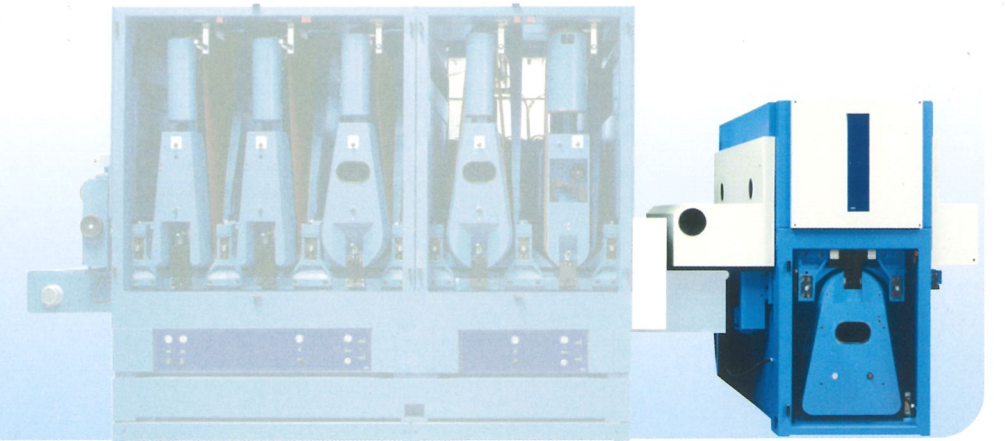

# Top calibrating - sanding machines for lines

K C

- available with 1 up to 6 working units.
- constant pass-line from floor.
- abrasive belt length 2620 / 3250 mm;
- working width 1350 - 1650 mm;
- thickness workable 0 ÷ 160 mm.

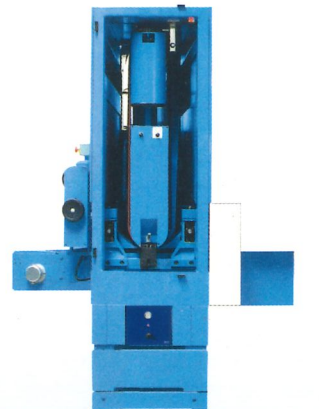

K CC

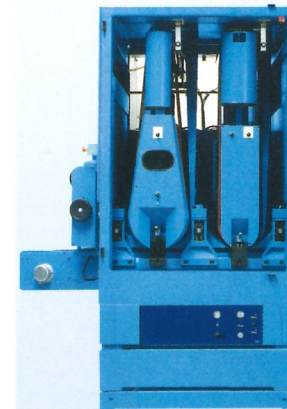

K CTT

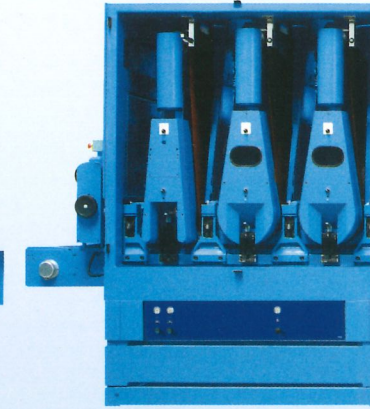

K CCCT

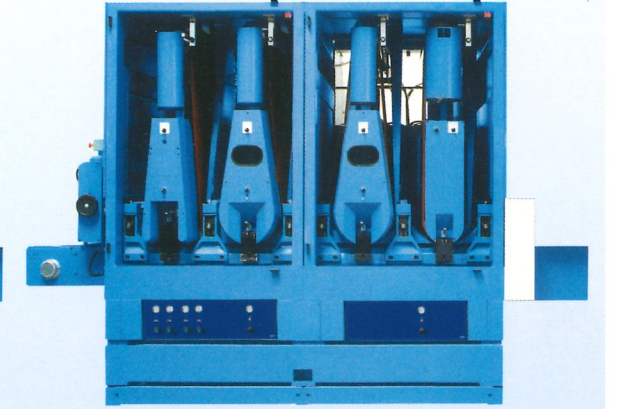

K CCCCT



K CCCCTT

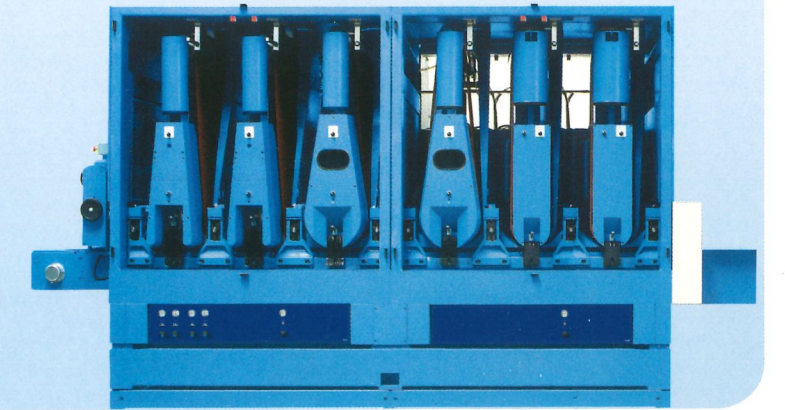



# Combined bottom + top calibrating - sanding machines

Series KKH are our "middle" range machines, with possibility to install high-power motors for high feed speed of production.

- centralized thickness adjustment with electronic programmer with 50 programmes;
- centralized feed speed adjustment from control panel of first machine;
- abrasive belt length 2620 - 3250 (top machine only) mm;
- working width 350 - 650 - 1350 mm;
- thickness workable 0 - 160 mm.

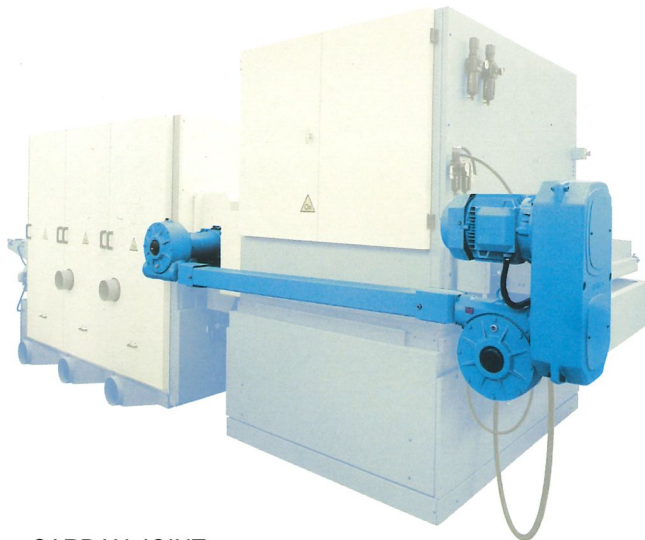

### CARDAN JOINT

It is a Costa Levigatrici feature the linkage with a mechanical system (with cardan joint) between the bottom and top sections, in order to avoid slippage or slow-down of panels between the feed units, with sanding marks or (worse) heavy wear of the feed belts.

The motors of the working units with up to 30 kW of power are positioned inside the frame, both in the top and in the bottom machines of Serie KKH.

Bigger power motors must be positioned outside

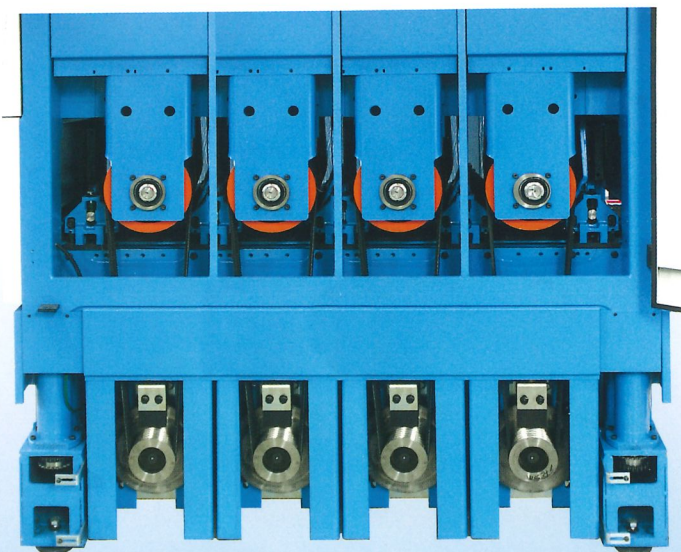

# Bottom calibrating - sanding machines

- available with 1 up to 4 working units;
- constant pass-line from floor;
- abrasive belt length 2620 mm;
- working width 350 - 650 - 1350 mm;
- thickness workable 0 ± 160 mm.

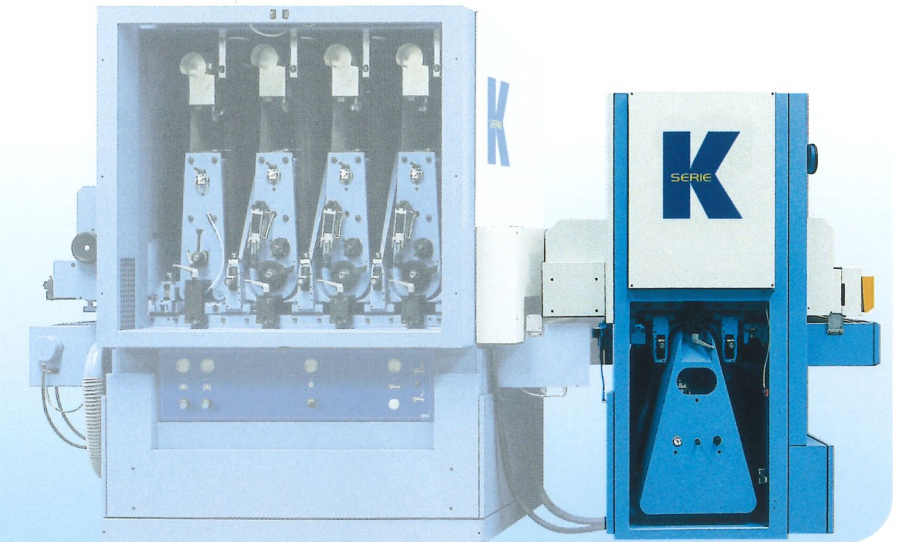

# Top calibrating - sanding machines for lines

- available with 1 up to 4 working units.
- constant pass-line from floor.
- abrasive belt length 2620 mm;
- working width 350 - 650 - 1350 mm;
- thickness workable 0 ± 160 mm.

**KH C**

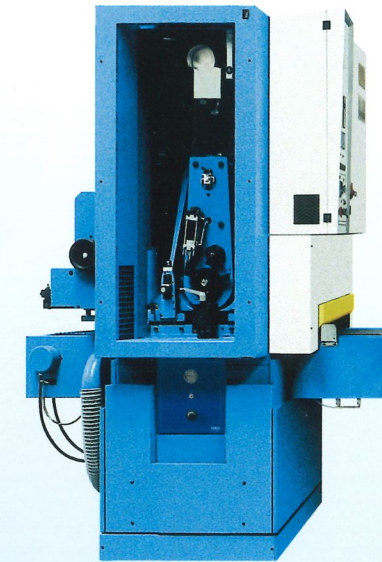

**KH CC**

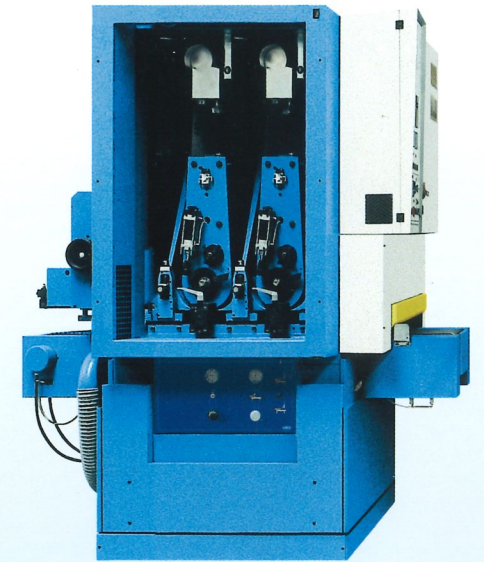

**KH CCT**

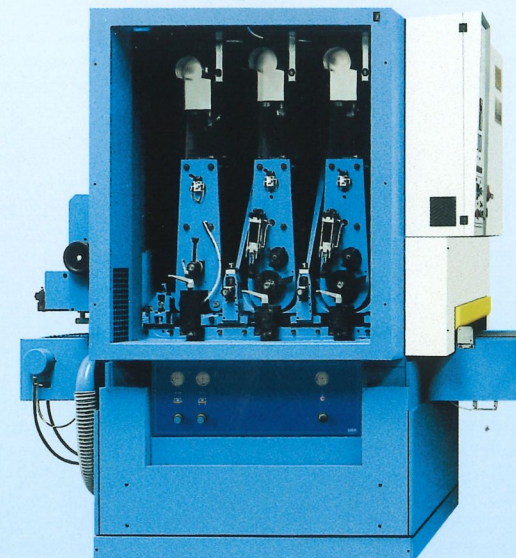

**KH CCCT**

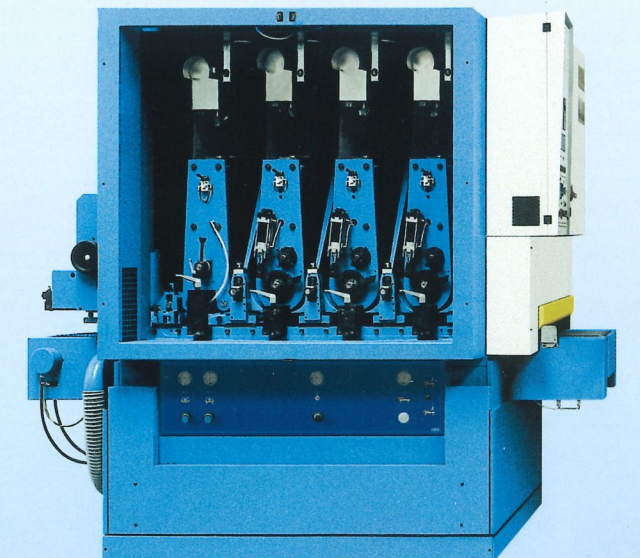



# Combined bottom + top calibrating - sanding machines

Machines of Series KKA are obtained by linking machines of Series KA from 1 to 4 units, and bottom machines of Series KBA from 1 to 3 working units;

- infeed + intermediate driven feed tables each with a length of 1000 mm;
- centralized thickness adjustment with electronic programmer with 50 programmes;
- centralized feed speed adjustment from control panel of first machine;
- abrasive belt length 2620 mm;
- working width 1350 mm;
- thickness workable 0 - 160 mm.

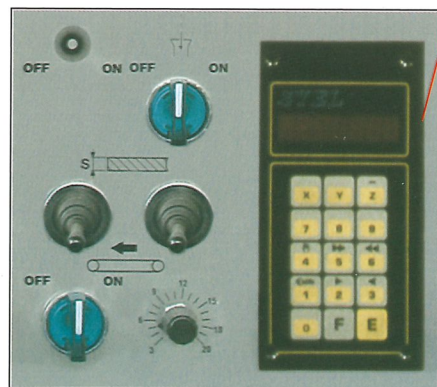

The thickness positioning of the two sections of machines is made by a thickness programmer that can either split the take away in automatic or can give different values to bottom and top sections; - possibility to store up to 50 different pre-programmed positions.

## KKA C - CCCT

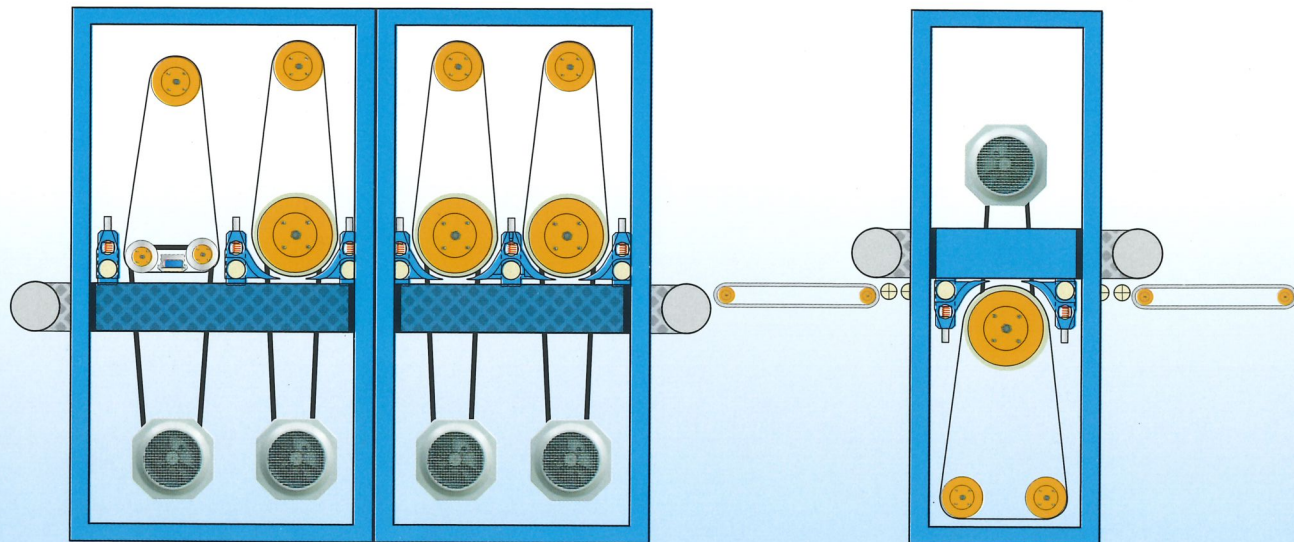

# Bottom calibrating - sanding machines

- available with 1 up to 3 working units;
- standard equipped with motorized in-feed table total length 1000 mm (to easy the loading of work-pieces);
- constant pass-line from floor;
- abrasive belt length 2620 mm;
- working width 1350 mm;
- thickness workable 0 ÷ 160 mm.

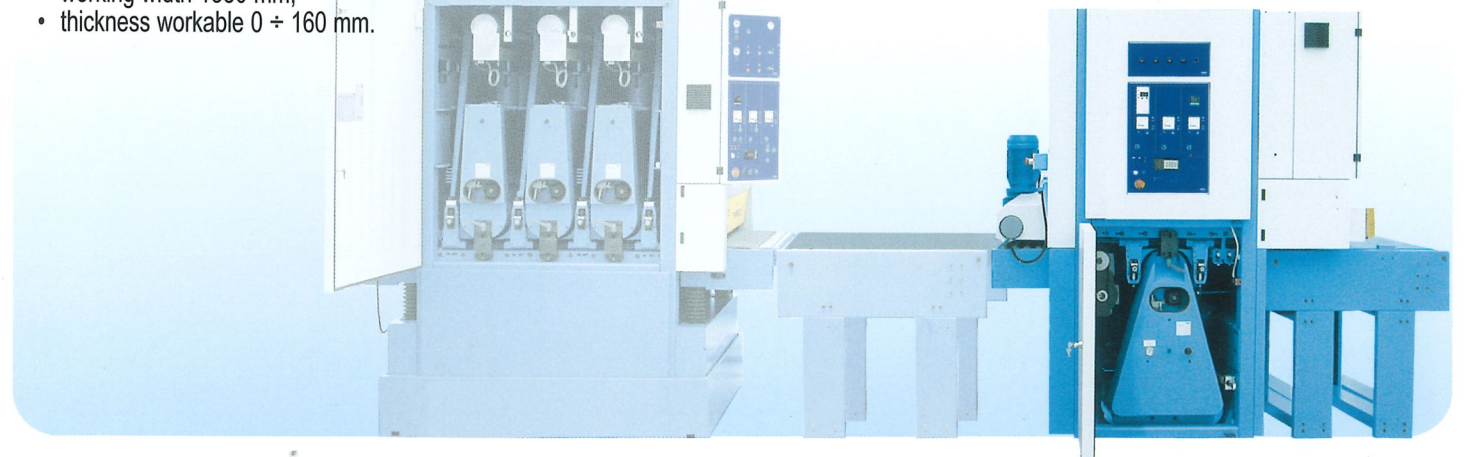

# Top calibrating - sanding machines for lines

## KA CT

- available with 2 up to 4 working units.
- constant pass-line from floor.
- abrasive belt length 2620 mm;
- working width 1350 mm;
- thickness workable 0 ÷ 160 mm.

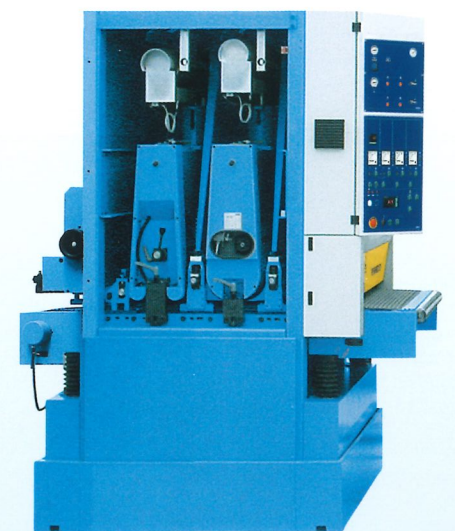

## KA CCC

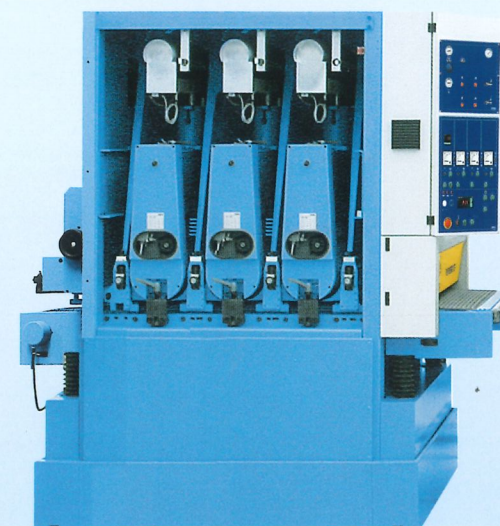

## KA CCCT

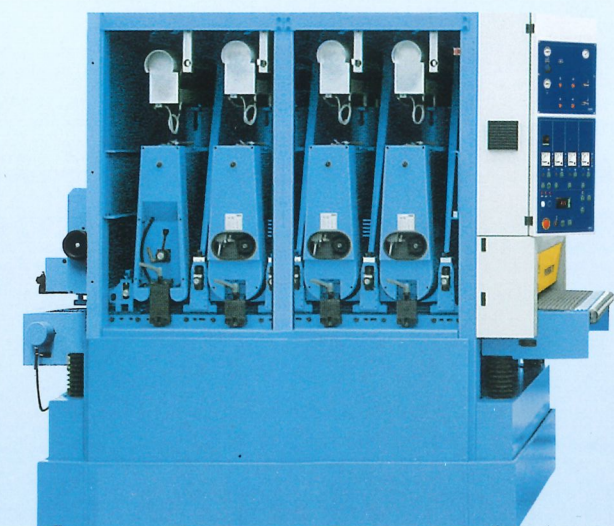

# BA-R series "Grain highlighting machines"



In Series BA-R the brush units have a diameter of 250 mm in steel, and are equipped with one speed motors from 4 kW with inversion of rotation and related dust hoods.

Series BA-R represents our proposal in the field of brushing machines for grain highlighting

- Is available with constant pass-line at 930 mm from floor, with movable head carrying the working units that allows a working thickness from 0 to 160 mm;
- working width 1350 mm;
- rubber feed belt drive system equipped with inverter 2,5 kW for variation of feed speed from 5 to 25 m/min in continuous;
- pressure unit for longitudinal units with rubber covered rollers spring-loaded;
- brush units of two types (see following examples);

In rear of machines we can insert another cleaning brush and / or rotary blowers.



To improve both the structuring depth we can increase the depth of pressure or insert the side oscillation system.  
To increase the feed speed we can have bigger motors on the brush units starting from kW. 5,5 to 7,5 to 11 to 15 to 22 each unit.  
In the brush unit, in addition to the steel brushes or inox at different density, we can insert anderson or tynex brushes, and/or finishing brushes with softer material to eliminate fuzz prior to staining.

**BA-R2** - grain highlighting machines with 2 steel brush units GS-25

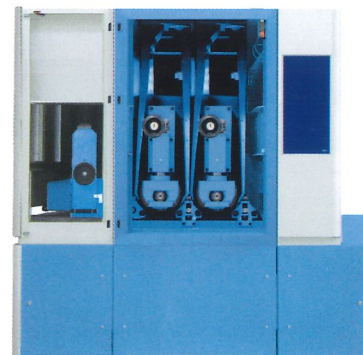

**BA-R3** - grain highlighting machines with 3 steel brush units GS-25

**BA-R4** - grain highlighting machines with 4 steel brush units GS-25

**BA-R5** - grain highlighting machines with 5 steel brush units GS-25

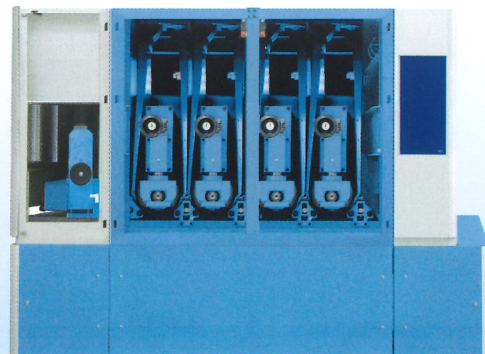
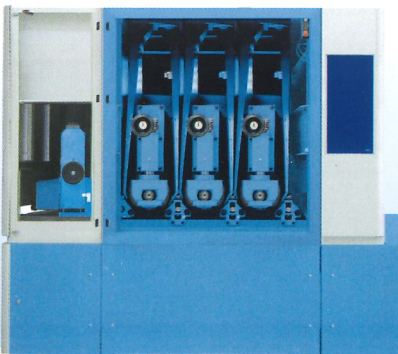

# BC3 - BC2 series "Brush machines for cleaning"

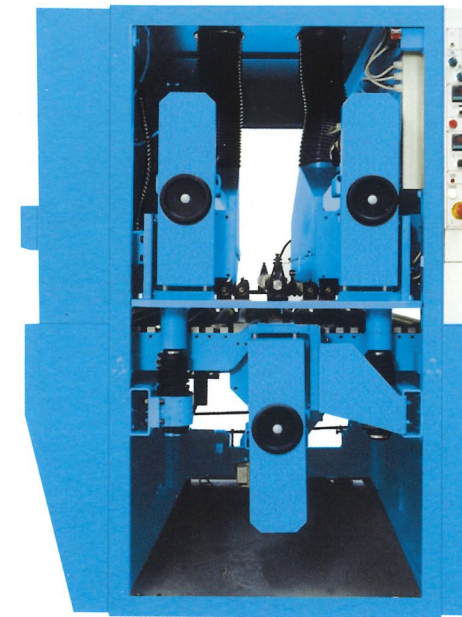

Brushing-cleaning unit with only top units or with bottom + top units, to insert in finishing lines at constant working height, with driven rollers drive system; the brushes are particularly flexible with very long helicoidal bristles, rotating opposite one another. They are equipped with a thickness opening system, adjustable from their own control panel or from the line control system or by the sanding machine control panel. Standard equipped with:

**Model BC3**

- 1 Bottom brush Ø 250 mm, motor kW 1,1
- 2 Top brush Ø 250 mm, motor kW 1,1 (each)

**Model BC2**

- 2 Top brushes Ø 250 mm, motor kW 1,1 (each)

Optional : antistatic or de-ionizing bars - rotary air jet blowers in machine rear

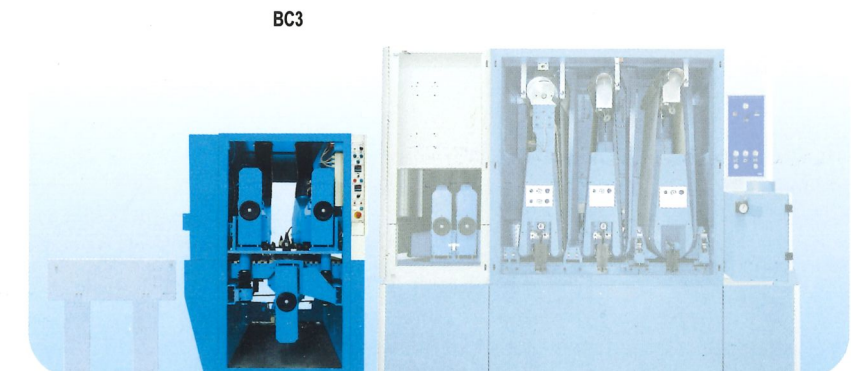
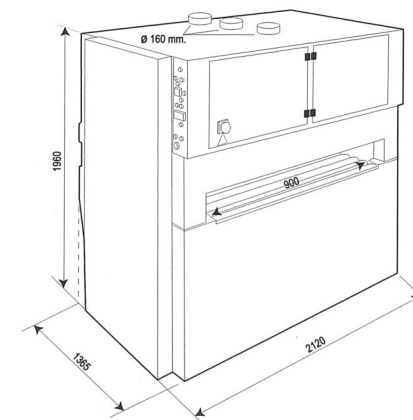
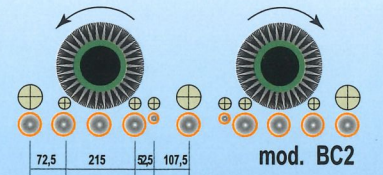
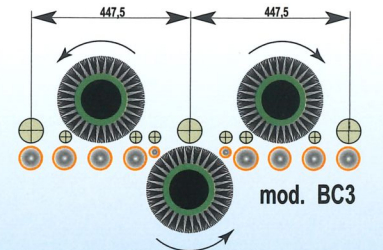

# The other lines in our range of products:



Universal  
Sanding-Calibrating Machines



Sanding Machines



Finishing brushing machines  
Structuring machines



We reserve the right to change features without any notice



COSTA LEVIGATRICI S.p.A.  
Via Venezia, 144 - 36015 Schio (VI) Italy  
Tel. (+39)0445-675000 - Fax (+39)0445-675110  
www.costalev.com - info@costalev.com