

S E R I E S

SMI-AZ/2



Rifilatrice

Trimming Machine

Machine Affleureuse

Buendigfrasemaschine

Perfilatora de Canto





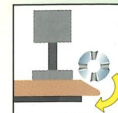

Freivol





SMI



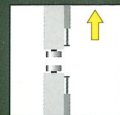

-  **SMI** Macchina semiautomatica, gestita da un PLC e con un inverter, per la rifilatura d'angoli su pannelli bordati in melaminico, impiallacciatura, PVC o ABS a spessore, con profili piani o soft-formati.
-  **SMI** Semi-automatic machine controlled by a PLC with inverter for trimming corners on panels edged in melamine, veneer, PVC or ABS with flat or soft-formed profiles.
-  **SMI** Máquina semiautomática, gestionada desde un PLC y accionada mediante un inverter para perfilar los ángulos de tableros chapeados con recubrimiento en chapa, PVC o ABS de distintos espesores, con perfilados planos o soft-formatados.
-  **SMI** Machine semi-automatique, gérée par un PLC et équipée d'un inverter, pour le rognage à épaisseur d'angles sur des panneaux bordés en mélamine, plaquage, PVC ou ABS, avec profils plats ou soft-formés
-  **SMI** Halbautomatische Maschine, über einen PLC betrieben und mit einem Wendegetriebe, für das Nachschneiden von Ecken an Platten mit Kanten aus Melamin, Furnierholz, entsprechend starkem PVC oder ABS, mit flachen oder softgeformten Profilen.

Freivol



 **AZ/2** Macchina rifilatrice per pannelli dritti e curvi, bordati con impiallacciatura, melaminica, PVC o ABS, con spessore fino a 3 mm. Con due motori a 12.000 giri, 0,37 kW comandati da un inverter.

 **AZ/2** Trimming machine for straight and curved panels, edged in veneer, melamine, PVC or ABS with thickness up to 3 mm. Two 12.000 r.p.m. 0,37 kW motors controlled by an inverter.

 **AZ/2** Máquina ribeteadora de cantos para tableros rectos y curvos, canteados con chapa, melamina, PVC o ABS con espesores de hasta 3 mm, accionando mediante 2 motores 0,37 kW a 12.000. r.p.m. gestionados mediante un inverter.

 **AZ/2** Machine affleureuse pour panneaux droits et courbés, en plaquage, mélaminé, PVC ou ABS, avec épaisseur jusqu'à 3 mm. Equipée avec deux moteurs à 12.000 tours 0,37 kW, commandé par un inverter.

 **AZ/2** Beschneidemaschine für gerade oder gewölbte Platten mit Kanten aus Furnierholz, Menamin, PVC oder ABS mit einer Stärke bis 3 mm. Mit zwei Motoren mit 12.000 Umdrehungen und 0,37 kW, von einem Wendegetriebe angetrieben.

AZ/2



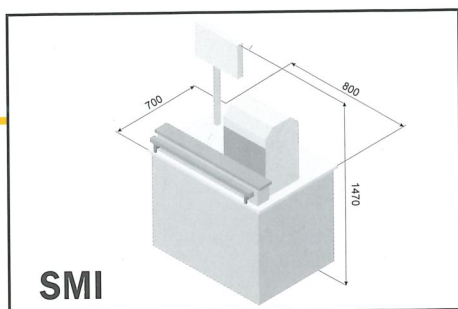

SMI

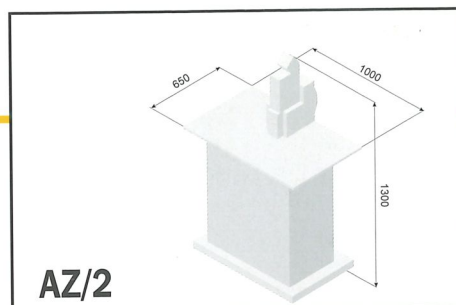

AZ/2

DATI TECNICI - SPECIFICATIONS - DONNES TECHNIQUES - TECHNISCHE ANGABEN - DATOS TECNICOS

Modello - Model - Modéle Modell - Modelo	Serie SMI	Serie AZ/2
Altezza pannello Panel height - Hauteur du panneau Werkstückstärke - Altura tablero	16 mm ÷ 52 mm	10 mm ÷ 60 mm
Raggio interno minimo Minimum internal radius - Rayon minimum interne Kleinster Innendurchmesser - Radio mínimo interno	21 mm	20 mm
Giri motore minuto Engine rpm - Tours minute du moteur Motorendrehzahl/Min. - Giros por minuto del motor	12.000 r.p.m.	12.000 r.p.m.
Voltaggi e frequenza Voltage and cycles - Voltage et fréquence Spannung, Frequenz - Voltaje y frecuencia	230V 50/60Hz SF	230V 50/60Hz SF
Pressione d'aria Air pressure - Pression Druck - Presion	6 bar	6 bar
Potenza installata Installed power - Puissance installée Leistung installierte - Potencia instalada	220 W	750 W
Peso Weight - Poids Gewicht - Peso	210 Kg	80 Kg

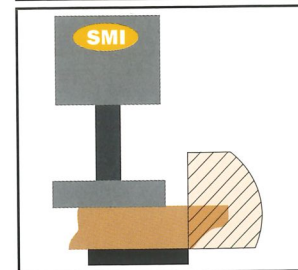
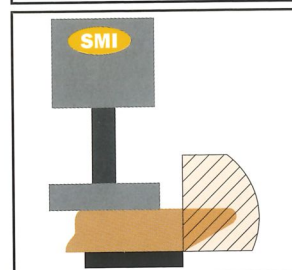
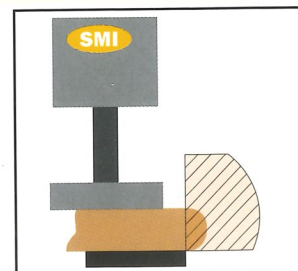
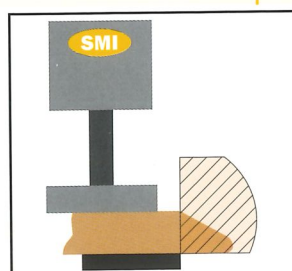
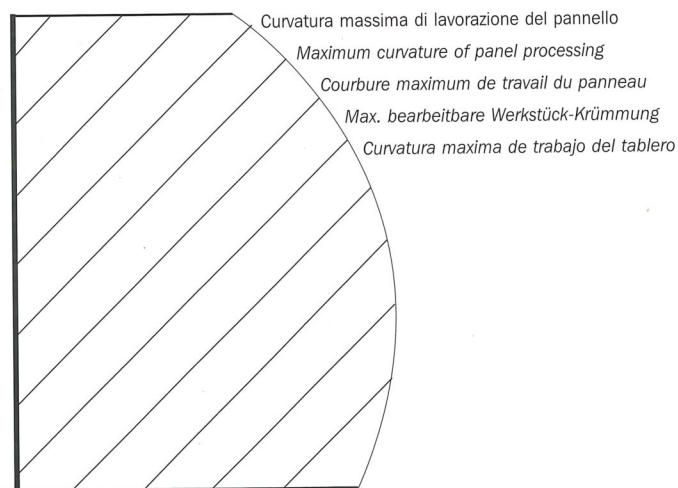

La Ditta si riserva di apportare qualsiasi modifica senza preavviso. - The Company reserves the right to alter any detail with no forewarning. - La maison réserve le droit d'apporter les modifications jugées utiles sans préavis. - Die Firma behält sich das Recht für Änderungen ohne Voranzeige vor. - La empresa se reserva cualquier modificación sin preavisar a los clientes.

Fravol

**MACCHINE PER LA LAVORAZIONE DEL LEGNO
MANUFACTURE OF WOODWORKING MACHINES**

Uff. e Dep.: Via A. Niedda, 5-7 - 35010 PERAGA di Vigonza - (PD) - Italy
Tel. +39 - 049 725085 - 725888 - Fax +39 - 049 8931635
e-mail: fravolexport@tin.it - fravol.export@tiscalinet.it

DEALER