

PANELMATIC

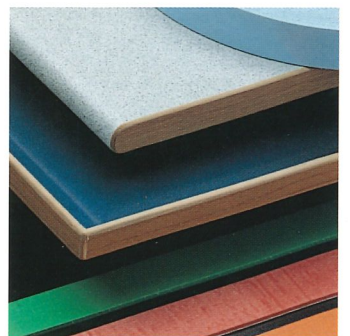

TOP VERSATILITY

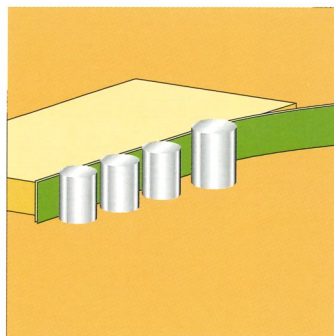
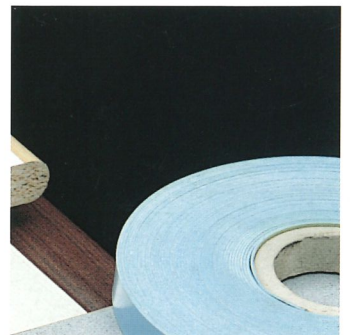
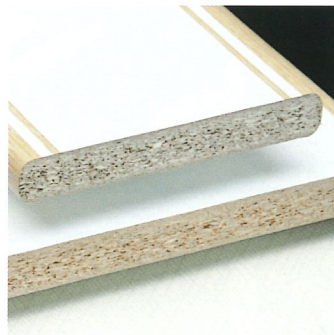
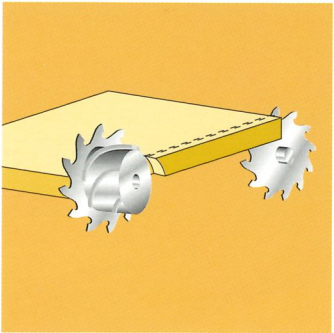
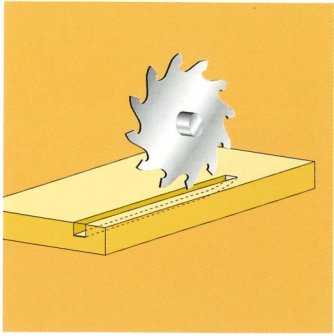

GRUPPO
DELMAC

gabbiani

PANELMATIC 1

SQUADRABORDATRICE DOPPIA MONOLATO
SINGLE SIDE DOUBLE TENONER EDGE BANDING MACHINE
COMBINADA PERFILADORA-CHAPADORA DOBLE UNILATERAL
EINSEITIGE DOPPELFORMATBEARBEITUNGS- UND KANTENANLEIMMASCHINE
TENONNEUSE-PLAQUEUSE DE CHANTS DOUBLE MONOLATERALE

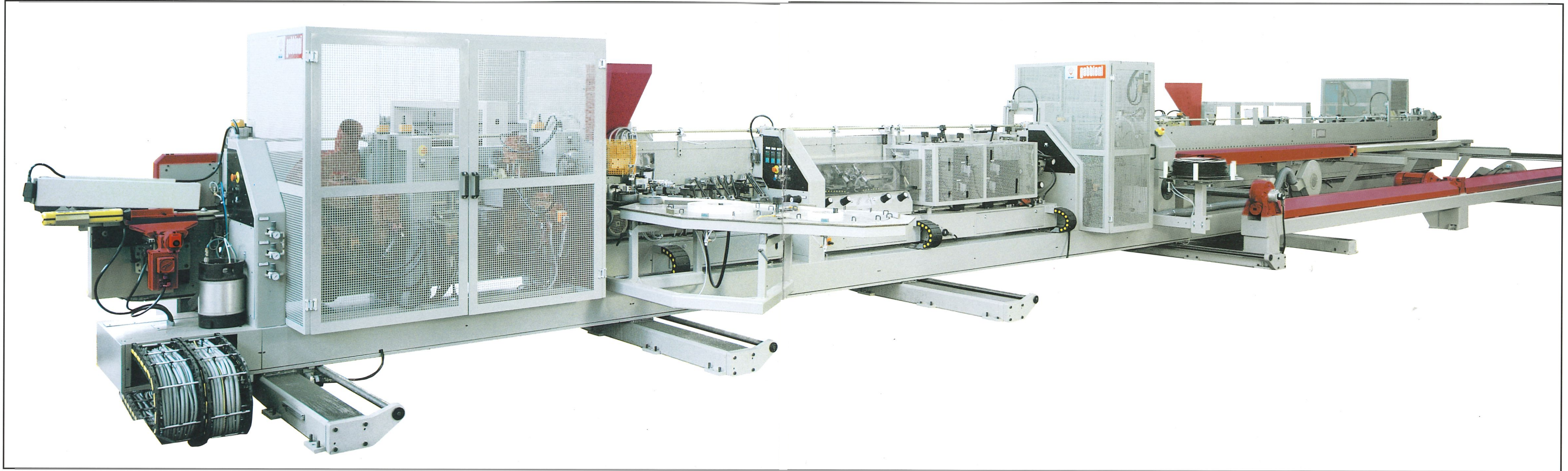

LAVORAZIONI

Squadratura longitudinale di pezzi stretti fino ad un minimo di 55 mm.

EFFICIENZA

Elevata produttività dovuta alla semplicità nell'eseguire lavorazioni e messe a punto tradizionalmente svolte su più macchine.

PROCESSINGS

Longitudinal sizing and edge banding processing of narrow workpieces up to a min. 55 mm in width.

EFFICIENCY

High productivity and accuracy to the offset base and mechanical linkage allowing small pieces to be efficiently handled.

TRABAJOS

Escuadrado, chapado longitudinal de piezas estrechas hasta un mínimo de 55 mm.

EFICACIA

Elevada producción debida a la sencillez en el manejo

BEARBEITUNGEN

Längsseitige Formatbearbeitung der schmalen Werkstücke bis zu min. 55 mm.

LEISTUNG

Hohe Produktionsleistung durch einfache Ausführung der Bearbeitung und Einstellungen, die an mehrere Maschinen ausgeführt werden.

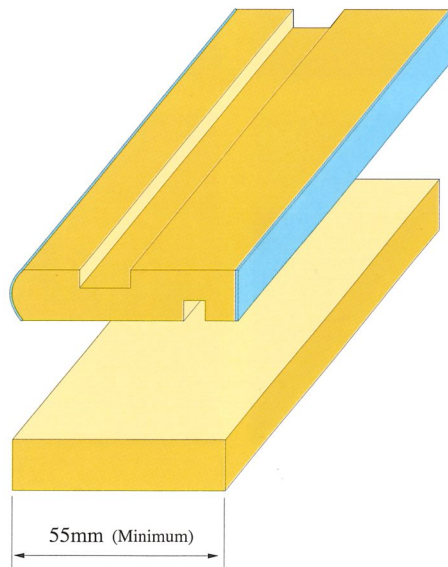

USINAGES

Equerrage et placage longitudinal des pièces jusqu'à un minimum de 55 mm.

EFFICACITE'

Productivité élevée grâce à la simplicité dans l'exécution des usinages et mis à point qui sont traditionnellement exécutées par plusieurs machines.



SQUADRATURA

Squadratura e profilatura di pannelli.

SQUARING PROCESSING

Sizing, squaring, profiling and tenoning of panels.

ESCUADRADO

Escuadrado y perfilado de paneles.

WINKELBEARBEITUNG

Winkel- und Profilarbeitung der Platten

EQUERRAGE

Equerrage et profilage des panneaux



ABS

Applicazione di bordi in ABS/PVC.

ABS

Application of ABS/PVC edges.

ABS

Aplicación de chapado en ABS/PVC.

ABS

Anleimung von Kanten in ABS/PVC

ABS

Application de chants en ABS/PVC



LEGNO

Applicazione di impiallacciatura e di listelli di massello.

WOOD

Application of veneer and solid wood panels.

MADERA

Aplicación a listones macizos.

HOLZ

Anleimung von Furnier und Massivleisten

BOIS

Application de placage et de pièces en bois massif



SOFT

Applicazione di bordi melaminici con procedimento softforming.

SOFT - Application of melamine edges by softforming procedure.

SOFT - Aplicación a melamina y proceso de softforming.

SOFT - Anleimung von Melaminkanten mit softforming Vorgang.

SOFT - Application de chants en mélamine avec procédé softforming.

PANELMATIC 2

**SQUADRABORDATRICE DOPPIA
DOUBLE TENONER EDGE BANDING MACHINE
ESCUADRADORA-CHAPADORA DOBLE
DOPPELFORMATBEARBEITUNGS-UND KANTENANANLEIMMASCHINE
TENONNEUSE-PLAQUEUSE DE CHANTS DOUBLE**



LAVORAZIONI

Squadrabordatura sui due lati di pannelli con profilo diritto e sagomato.

BASAMENTI

Basamento di guida dotato di guida rettificata e pattino a ricircolo di sfere. Montanti con scorrimento a velo d'aria.

PROCESSINGS

Edge banding processing.

MACHINE BEDS

Machine bed equipped with rectified guide and square linear bearing. Vertical rods with air veil sliding.

TRABAJOS

Escuadrado, chapado sobre dos lados de paneles a perfil directo y perfilado.

BASE

Base de maquina dotato de guias rectificadas y patines de recirculacion a bolas. Montantes con deslizamiento a velo de aire.



BEARBEITUNGEN

Zweiseitige Formatbearbeitung und Kantenanleimung von Platten mit geradem und geformtem Profil.

GESTELLE

Führungsgestell mit geschliffener Führung und Kugelumlauf-Führungswagen. Stützgestell mit Luftkissen-Gleitsystem.

USINAGES

Tenonage-équerrage sur le deux côtés des panneaux avec profil droit et façonné.

BASEMENTS

Basements de guide équipé avec guide rectifiée et patin à recirculation de billes. Montants avec écoulement à voile d'air.

CINGOLO

Catena di trasporto di elevata precisione con scorrimento a "rotolamento" mediante cuscinetti per alte velocità.

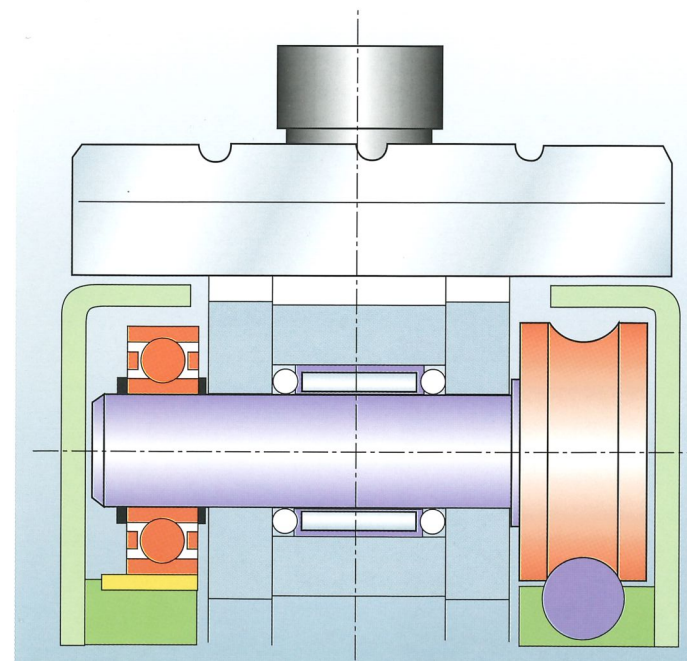

CHAINS

High precision feed chain with large driving sprocket and ball bearings for high speeds.

CADENA

Cadena de transporte de elevada precision con deslizamiento rotativo por cojinetes para elevada velocidad.

KETTE

Transportkette mit hoher Genauigkeit und Rollengleitung mittels Kugellager für hohe Geschwindigkeit.

CHAINE

Chaîne d transport de haute précision avec écoulement à "roulement" par coussinet pour hautes vitesses.

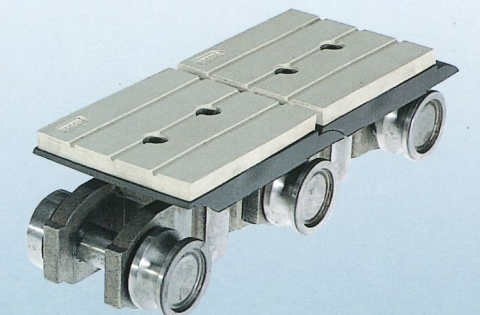

PANELMATIC

IN LINEA DI LAVORAZIONE
 IN LINE PROCESSING
 EN LINEA DE TRABAJO
 IN BEARBEITUNGSTRASSE
 EN LIGNE D'USINAGE

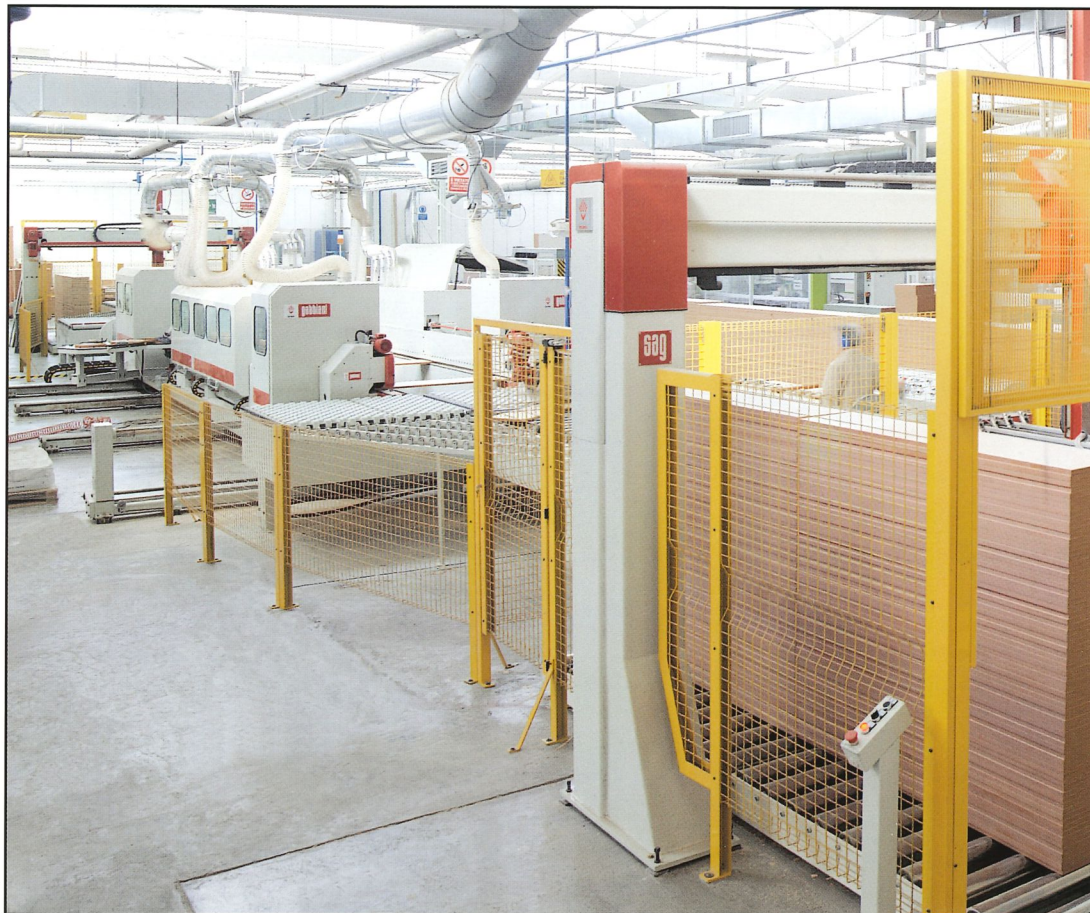
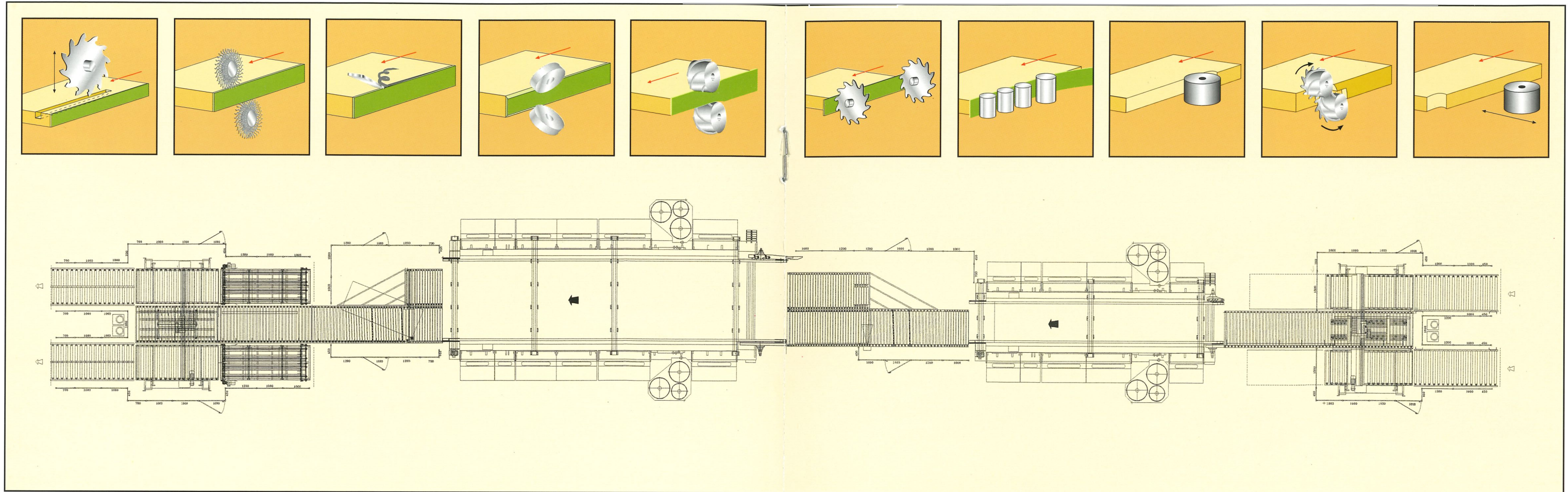

1) Gruppo incollaggio bordi dritti
 Unit for glueing straight edges
 Grupo de encolado para cantos rectos
 Aggregat zum Anleimen von geraden Kanten
 Groupe encollage chant droit

2) Gruppo incollaggio softforming
 Unit for softform glueing
 Grupo de encolado softforming
 Aggregat zum Softform- Anleimen
 Groupe encollage softforming

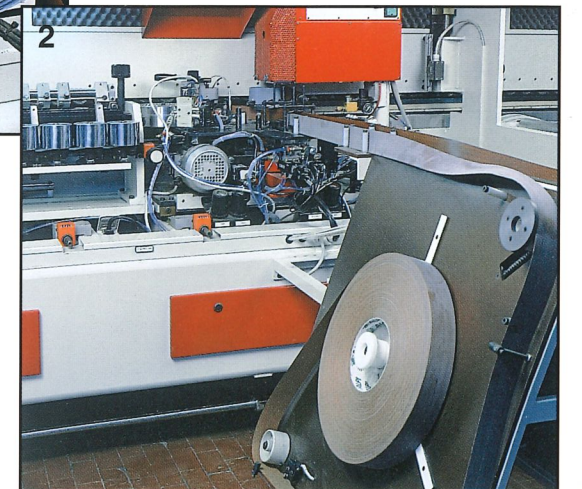

GRUPPI OPERATORI

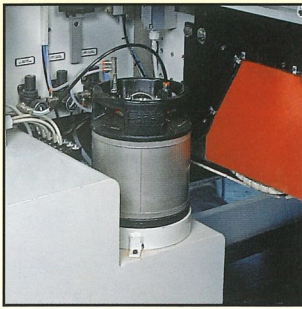

Anti-adesivizzanti
Antiadhesive
Anti-adhesivizador
Antiklebandaggregat
Antiadhésif

1

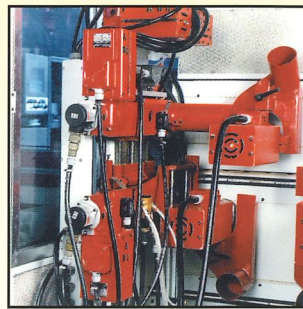
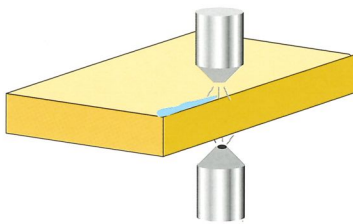

Incisore automatico inferiore 227K
Incisore fisso superiore
Bottom automatic scoring unit 227K
Top fixed scoring unit
Incisor automatico inferior 227K
Incisor fijo superior
Unteres autom. Vorritzaggregat 227K
Oberes festes Vorritzaggregat
Inciseur automatique inférieur 227K
Inciseur fixe supérieur

1

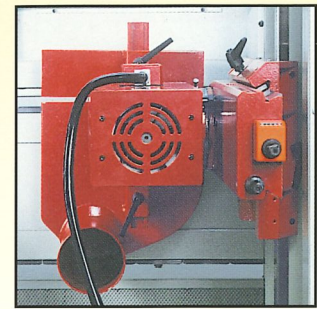
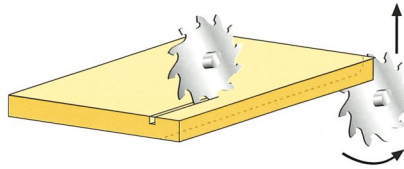

Truciolatore inferiore
Bottom hogging unit
Triturador inferior
Unteres Zerspaneraggregat
Déchiqueteur inférieur

1

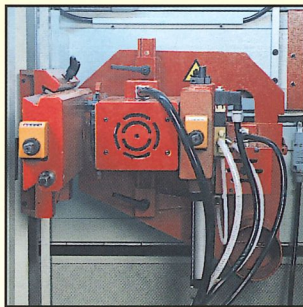
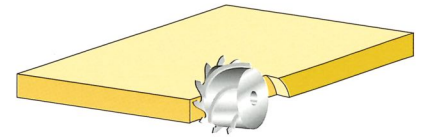

Incisore truciolatore 470R
Scoring – hogging unit, 470R
Incisor triturador 470R
Vorritzer – Zerspaner 470R
Inciseur - déchiqueteur 470R

1

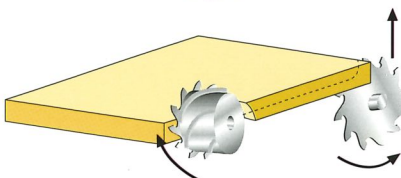

Doppio truciolatore sovrapposto TDS
Top and bottom double hogging unit, TDS
Doble triturador sobrepuesto TDS
Doppelzerspaner oben/unten TDS
Double déchiqueteur superposé TDS

1

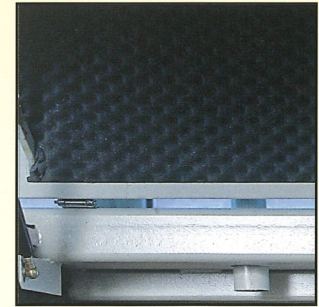
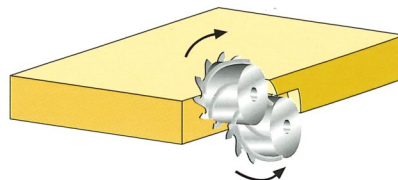

Toupie automatica 325 R
Automatic milling unit, 325R
Tupi automatica, 325R
Fräsaggregat mit Einsatzsteuerung 325R
Toupie automatique 325R

1

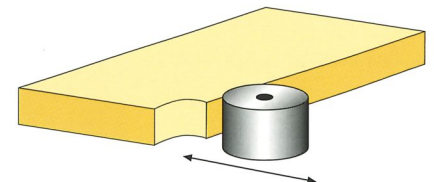

1 Sezione a squadrare
 Squaring section working units
 Grupos operadores seccion de escuadrado
 Aggregate zur formatbearbeitung
 Groupes operateurs section d'équerrage

2 Sezione a bordare
 Edge banding section working units
 Grupos operadores seccion chapado
 Aggregate zum kantenanleimen
 Groupes operateurs section de placage

WORKING UNITS
GRUPOS OPERADORES
ARBEITSAGGREGATE
GROUPES OPERATEURS

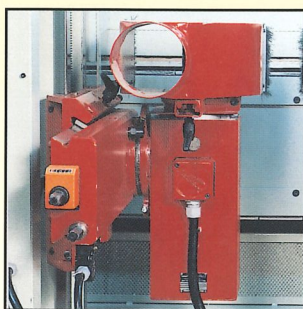

Toupie fissa
 Fixed milling unit
 Tupi fija
 Universalfräsaggregat
 Toupie fixe

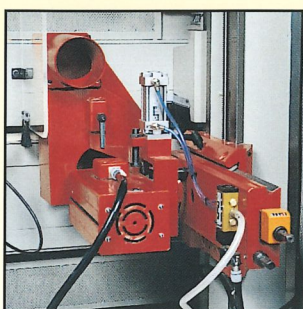

Toupie automatica orizzontale, 480R
 Automatic horizontal growing unit, 480R
 Tupi automatica horizontal, 480R
 Fräsaggregat mit schwenkbarer
 Einsatzsteuerung 480R
 Toupie automatique horizontale 480R

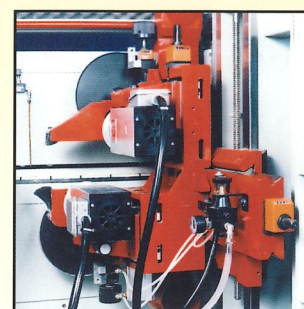

Profilatore orizzontale sup./inf. GPS
 Top/bottom horizontal profiling unit GPS
 Perfilador horizontal superior/inferior GPS
 Unteres u.oberes Horiz. Fräsaggregat GPS
 Groupe à profiler horizontal
 supérieur/inférieur GPS

1

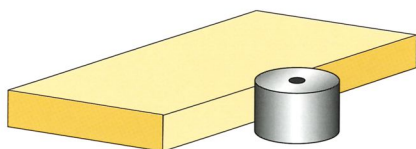

1

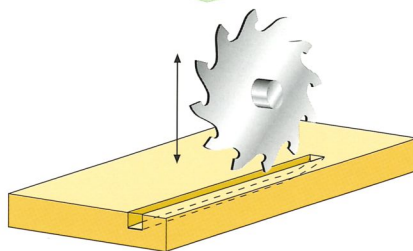

1

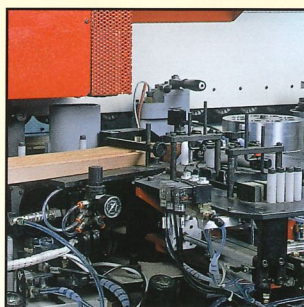
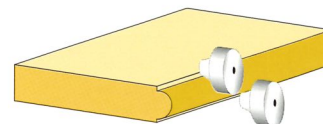

Gruppo incollaggio bordi dritti
 Unit for glueing straight edges
 Grupo de encolado para cantos rectos
 Aggregat zum Anleimen von
 geraden Kanten
 Groupe encollage chant droit

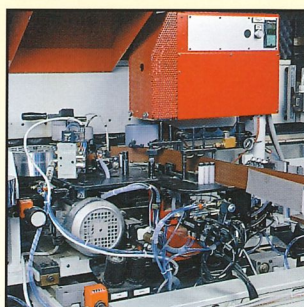

Gruppo incollaggio softforming
 Unit for softform glueing
 Grupo de encolado softforming
 Aggregat zum Softform- Anleimen
 Groupe encollage softforming

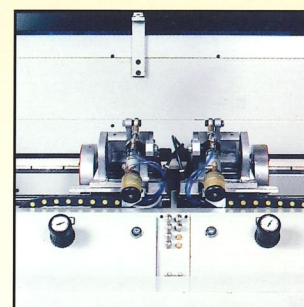

Intestatore GI
 End trimming unit GI
 Intestador GI
 Kappaggregat GI
 Groupe tronçonner GI

2

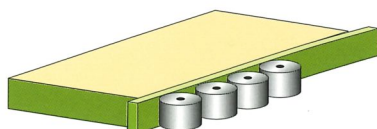

2

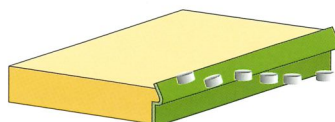

2

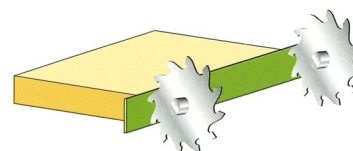

GRUPPI OPERATORI

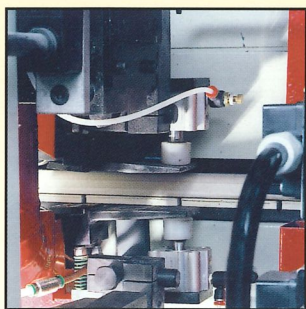

Raschiatore per soft GRF
Scraping unit for soft GRF
Rascador para sof GRF
Ziehklingenaggregat GRF für Soft
Groupe racleur pour soft GRF

2

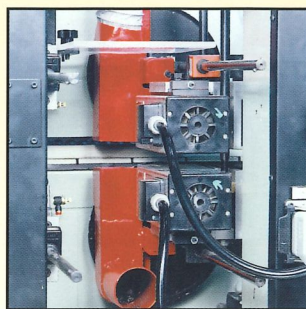
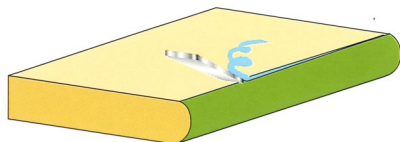

Refilatore GR
Top and bottom rough unit GR
Refilador GR
Ebenfräsaggregat GR
Groupe d'affleurage GR

2

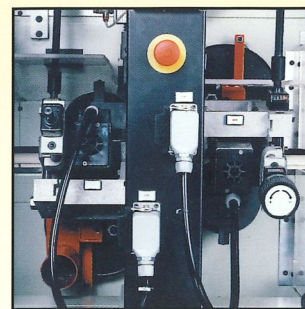
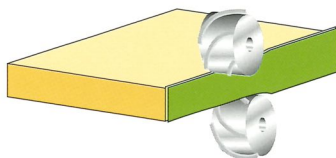

Spigolatore GS
Top and bottom fine unit GS
Espigador GS
Fasenfräsaggregat GS
Groupe à chanfreiner GS

2

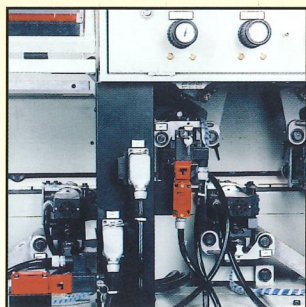
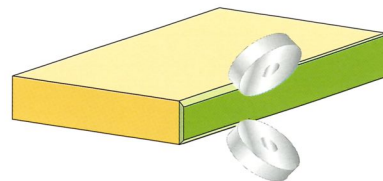

Copiatore / Arrotondatore G1-G2
Coping/corner rounding unit G1-G2
Copiador/redondeador G1-G2
Kopier-Abrundaggregat G1-G2
Groupe copieur/groupe à arrondir G1-G2

2

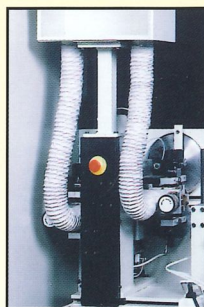
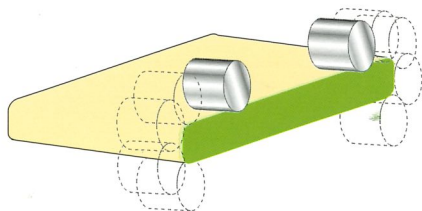

Raschiatore per ABS, mod. GRS
Scraping unit for ABS, mod. GRS
Rascador para ABS, mod. GRS
Ziehklingenaggregat für ABS, mod. GRS
Groupe racleur ABS, mod. GRS

2

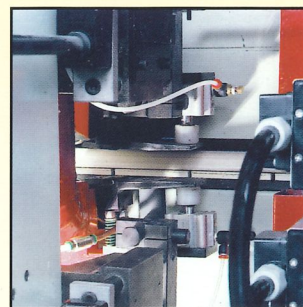
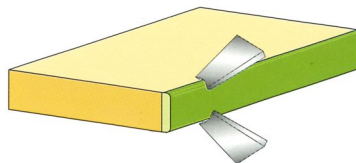

Raschiatore autolivellante GRA
Self-levelling scraping unit GRA
Rascador autonivelante GRA
Selbstjustierbares Ziehklingenaggregat
Groupe racleur GRA

2

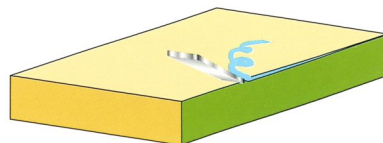

① Sezione a squadrate
 Squaring section working units
 Grupos operadores seccion de escuadrado
 Aggregate zur formatbearbeitung
 Groupes operateurs section d'équerrage

② Sezione a bordare
 Edge banding section working units
 Grupos operadores seccion chapado
 Aggregate zum kantenanleimen
 Groupes operateurs section de placage

WORKING UNITS
GRUPOS OPERADORES
ARBEITSAGGREGATE
GROUPES OPERATEURS



Levigatore a nastro G3P
 Belt sanding unit, G3P
 Lijador a banda, G3P
 Bandschleifaggregat G3P
 Groupe à poncer en bande G3P

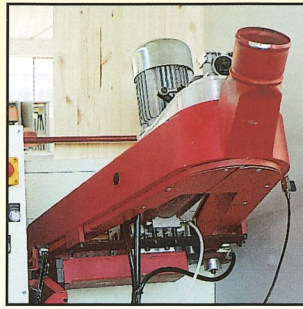

Levigatore a nastro per profili
 Belt sanding unit for profiles
 Lijador a banda para perfiles
 Profilbandschleifaggregat
 Groupe à poncer pour profils

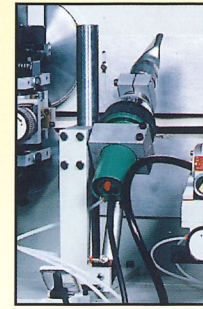

Phon
 Hot air blower
 Phon
 Phon
 Phon

②

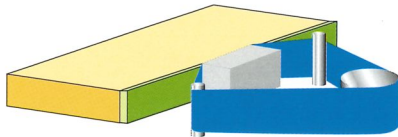

②

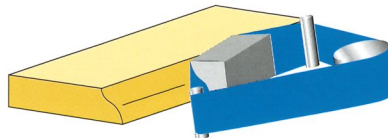

②

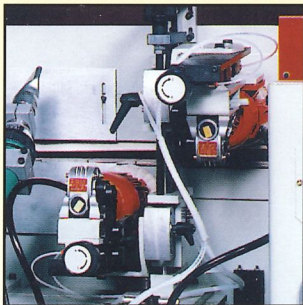
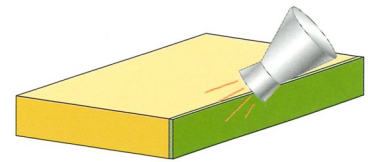

Spazzole
 Oscillating brushing unit
 Cepillador
 Polieraggregate
 Brosses

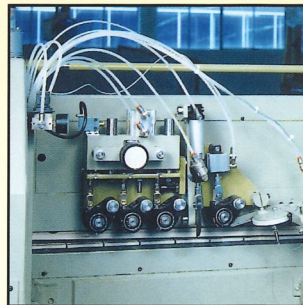

Inseritore IS
 Inserting units IS for edge T-slot insert
 Insertador IS
 Dichtungseinsetz-Aggregat IS
 Groupe d'introduction IS

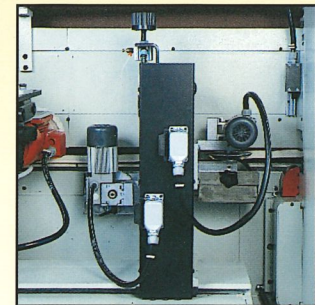

Tinteggiatori
 Painting roller unit
 Tintador
 Farben-Auftragaggregat
 Groupe de peinture

②

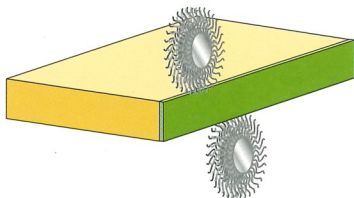

②

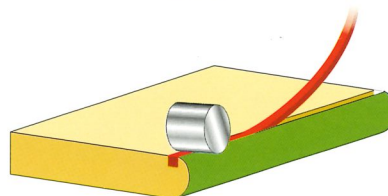

②

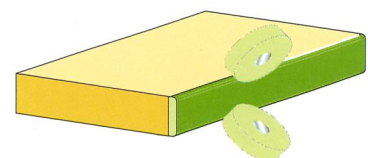

LAVORAZIONE PORTE

DOOR PRODUCTION
ELABORACION PUERTAS
TÜREMBEARBEITUNG
USINAGES PORTES

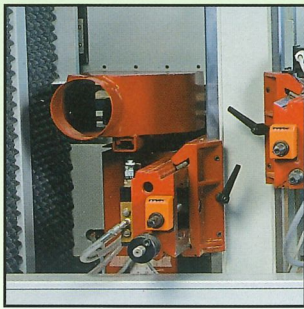

Toupie automatica antischeggia 325R
325R automatic operating unit
to prevent splitting
Toupie automatique pare-éclat, 325R
325R automatisches Arbeitsaggregat mit
Antisplitterfunktion
Tupi automatica anti astillas, 325R

2

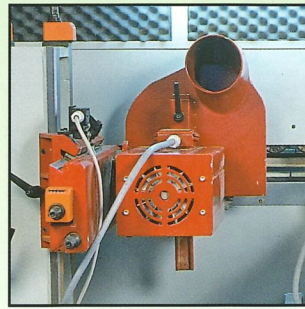
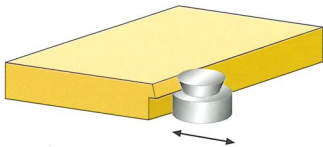

Truciolatore superiore inclinato
Inclined top hogging unit
Tritrador superior inclinado
Oberes Zerspanaggregat mit
Schrägstellung
Déchiqueteur supérieur incliné

2

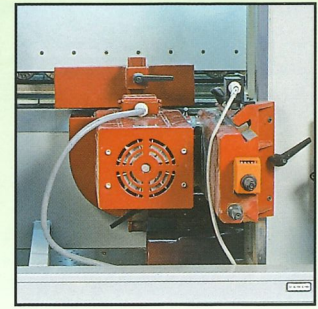
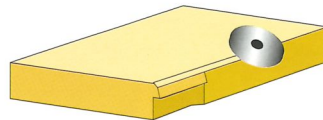

Truciolatore inferiore
Bottom hogging unit
Tritrador inferior
Unteres Zerspanaggregat
Déchiqueteur inférieur

2

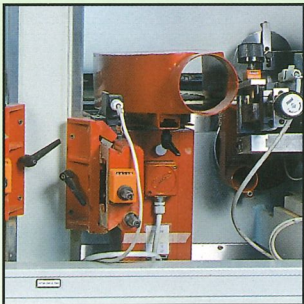
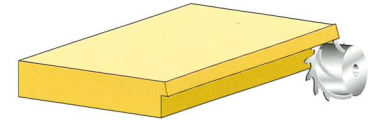

Toupie fissa porta-lama
Fixed sawing unit
Tupi fija porta-sierra
Fixes Sägeaggregat
Toupie fixe porte-lame

2

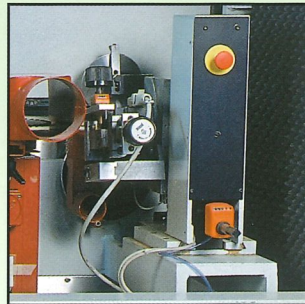

Gruppo spigolatore GS
GS chamfering unit
Grupo perfilador GS
GS Kantenabschrägaggregat
Groupe à chanfreiner GS

2

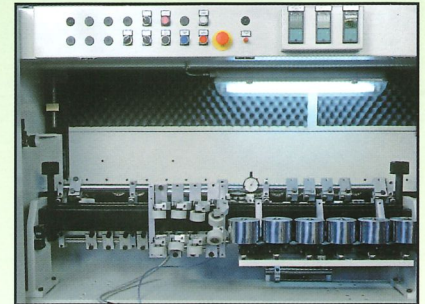
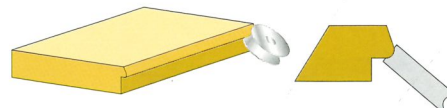

Gruppo incollaggio softforming
Unit for softform glueing
Grupo encolado softforming
Aggregat zum Softform-
Anleimen
Groupe encollage softforming

2

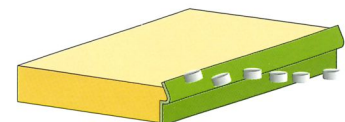

LAVORAZIONE PORTE

DOOR PRODUCTION
ELABORACION PUERTAS
TüREMBEARBEITUNG
USINAGES PORTES



Gruppo incollaggio bordi dritti
Unit for glueing straight edges
Grupo encolado cantos rectos
Aggregat zum Anleimen von geraden Kanten
Groupe encollage chant droit

2

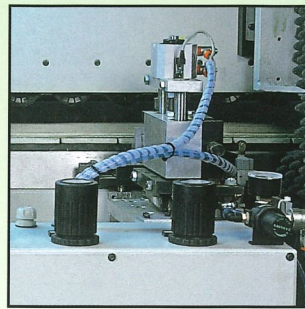
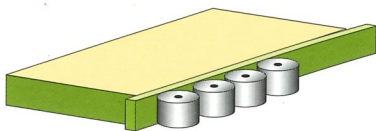

Scalpello pneumatico orizzontale
Pneumatic horizontal chisel
Zapata neumatica horizontal
Pneumatisch gesteuerter
Horizontal- Meißel
Racleur pneumatique horizontal

2

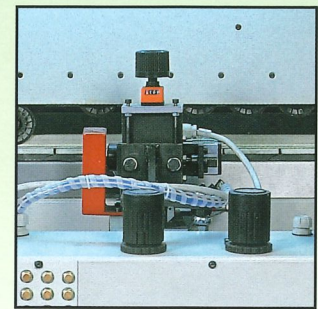
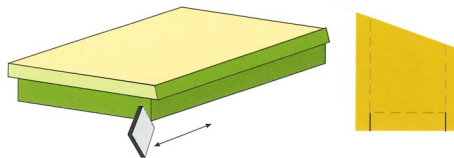

Intestatore bordo parte piana interna
End trimming unit for flat inner side
Retestador, canto parte recta interna
Kantenkappaggregat für
flache - Innenseite
Coupe en bout du bord interieur

2

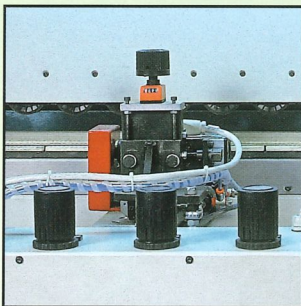
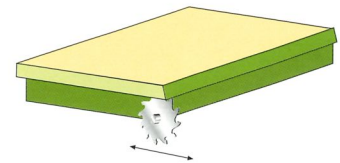

Intestatore bordo parte inclinata esterna
End trimming unit for inclined outer side
Retestador canto parte inclinada externa
Kantenkappaggregat für schräge - Außenseite
Coupe en bout de la partie inclinée extérieure

2

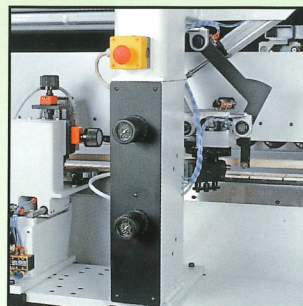
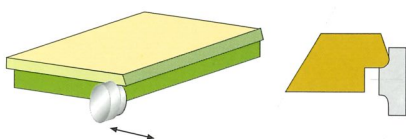

Gruppo fresatore bordo incollato
bordatura trasversale
Cope unit for processing of transversal edges
Grupo fresador encolado, canteado transversal
Fräsaggregat zur Bearbeitung der angeleimten
Querante
Groupe de fraiseage du bord transversal.

2

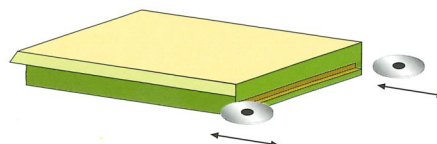

Gruppo stondatore-refilatore bordi soft
giunzione 45°
Corner rounding unit for softform edges with
45° jointing
Grupo redondeador-refilador, cantos softfor-
ming unión 45°
Abrundaggregat für Softformkanten mit 45° Fügung
Groupe d'affleurage-arrondisseur, chants
softformés et jonction à 45°

2

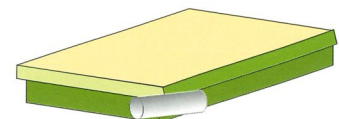



GABBIANI

29027 Podenzano (PC) Italy
Via Roma, 101
Tel. +39 523 559922
Fax +39 523 556201
e-mail: delmac@gabbiani.it



CELASCHI S.p.A.

29020 VIGOLZONE (PC)
Via F. e G. Celaschi, 25
Tel. ++39 0523 876811
Fax ++39 0523 876876
e-mail: info@celaschi.com



DELMAC ITALY

Delmac S.p.A.
36016 Thiene (VI)
Via Della Fisica, 20
Tel. +39 445 313111
Fax +39 445 313150
e-mail: delmac@delmac.it



DMG

DMG - Delmac Machinery Group U.S.A.
4322 Piedmont Parkway - Greensboro, NC 27410
Tel. 336 854-1211
Fax 336 854-0811
e-mail: delmac@nr.infinet

gabbiani

GABBIANI
29027 Podenzano (PC) Italy
Via Roma, 101
Tel. +39 523 559922 Fax +39 523 556201
e-mail: delmac@gabbiani.it

