

Profil- und Werkzeugbeispiele

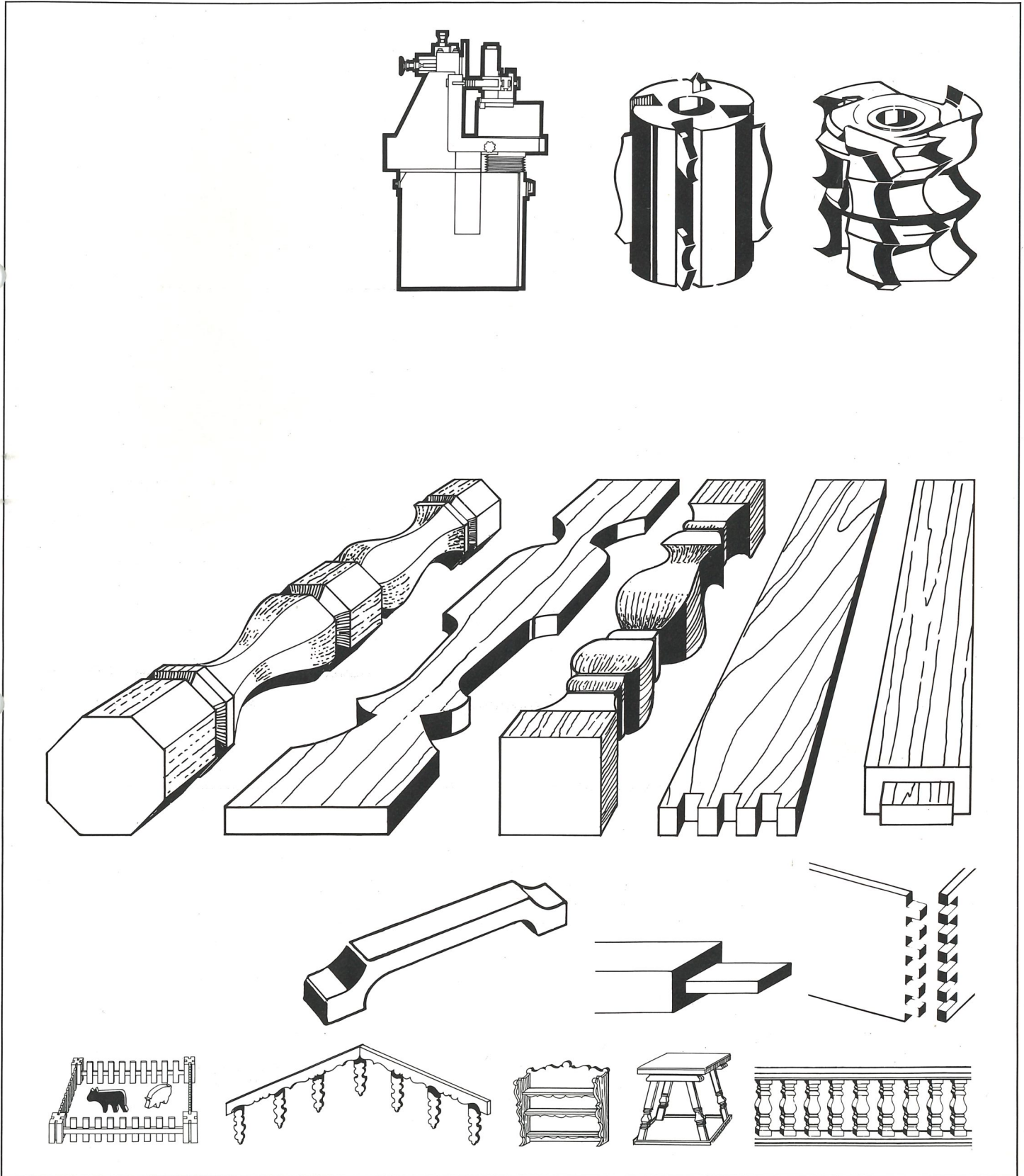

Möbel

Stilmöbel

Türstock-
Umrandungen

Polstergestelle

Stil-Hängebord

Gehäuse für
Stil-Standuhren

Landhaus- und
Bauernmöbel

Lichtblenden
für indirekte
Beleuchtung

Möbel-Holzgriffe

Heizkörper-
verkleidungen

Bilderrahmen

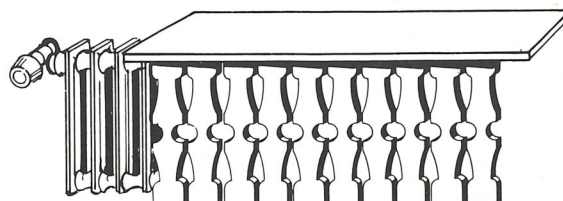
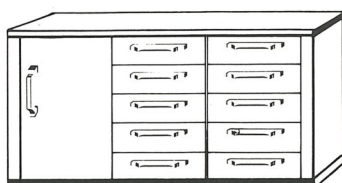
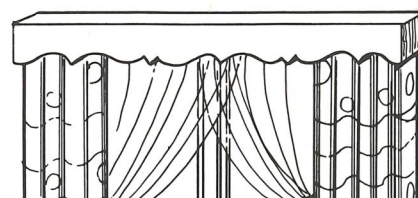
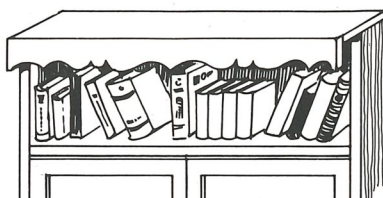
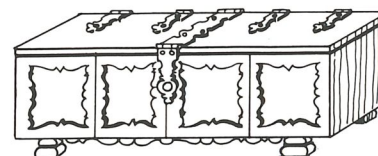
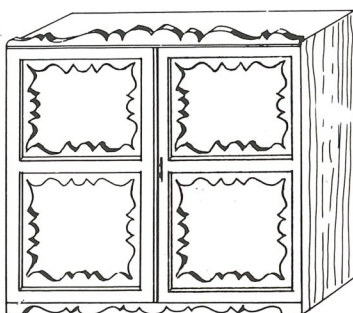
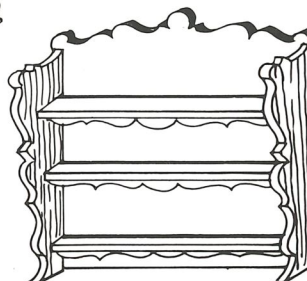
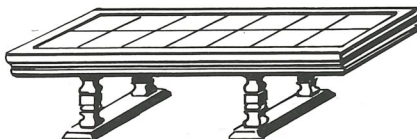
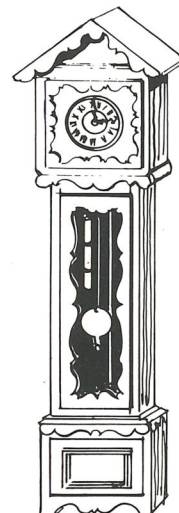
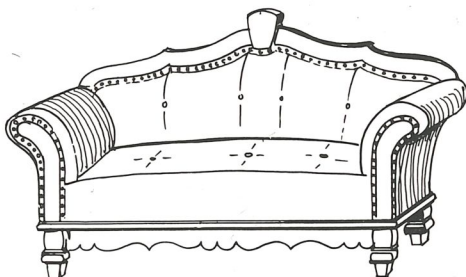
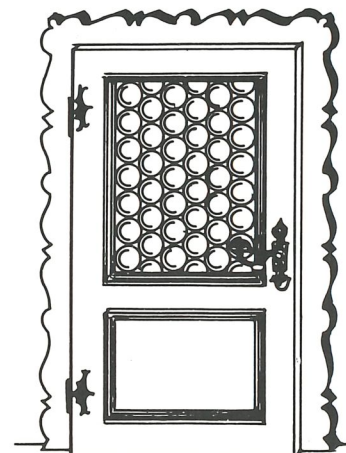
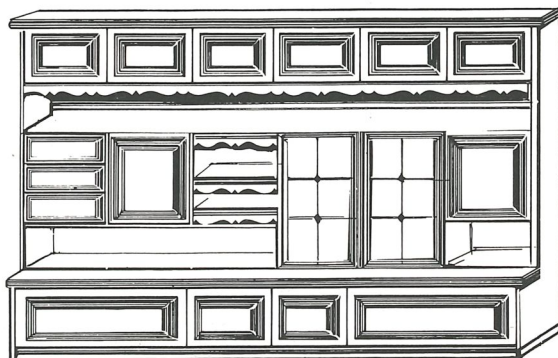

Spielwaren

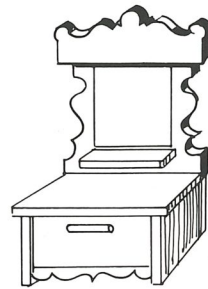
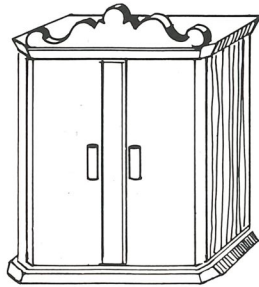
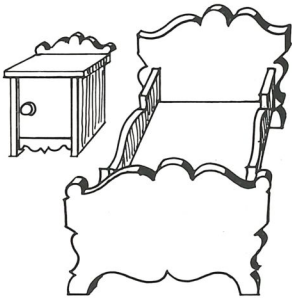

Puppenmöbel

Autos

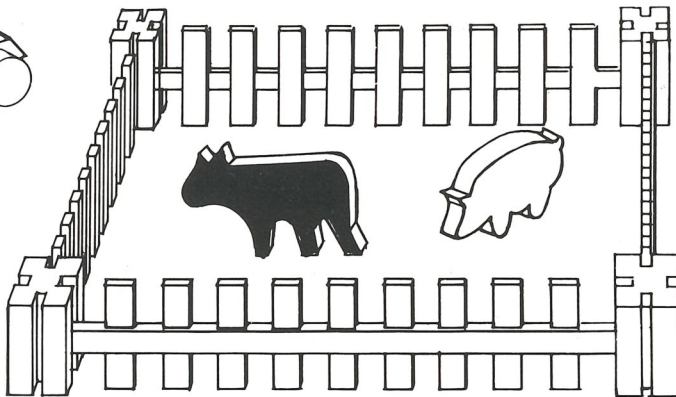
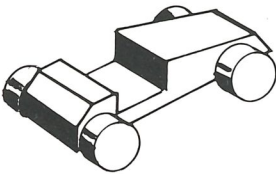

Tierformen

Steck-Weidezäune

Steck-Bausätze

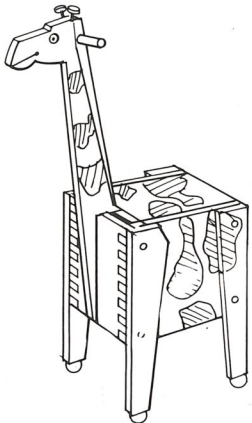

Truhentiere

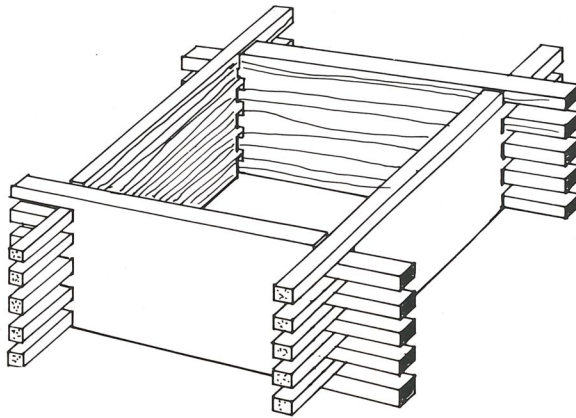

Spielzeugkisten

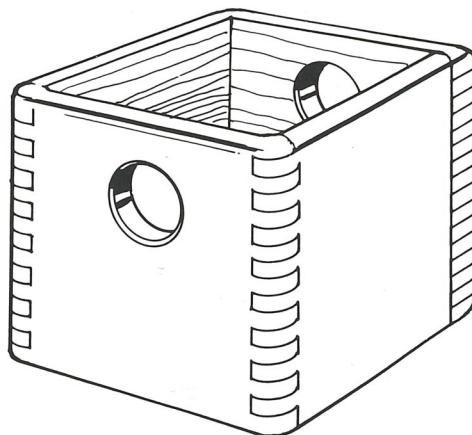
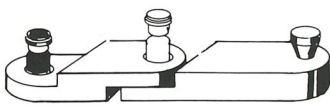
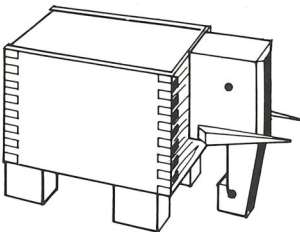

Holzbau

Balkonbaluster

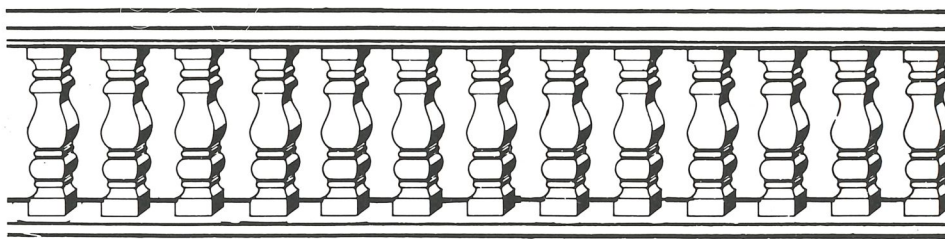

Ortgang-
verkleidungen

Sparrenköpfe

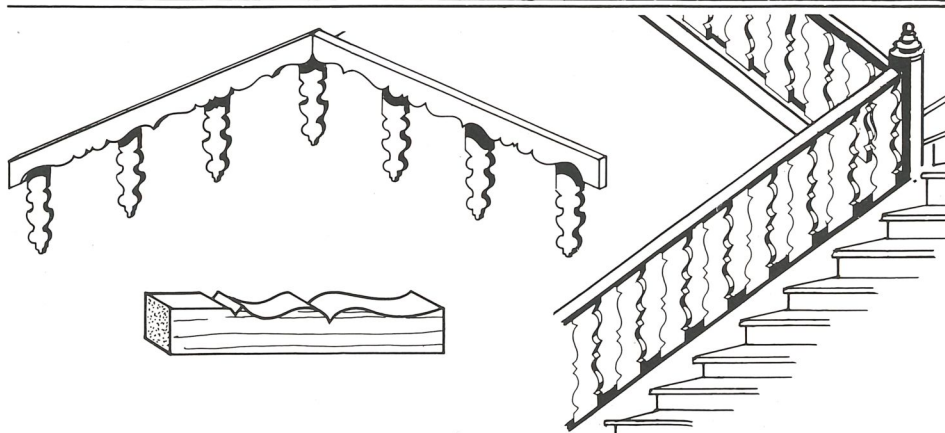

Treppenbau

Balkon-
verkleidungen

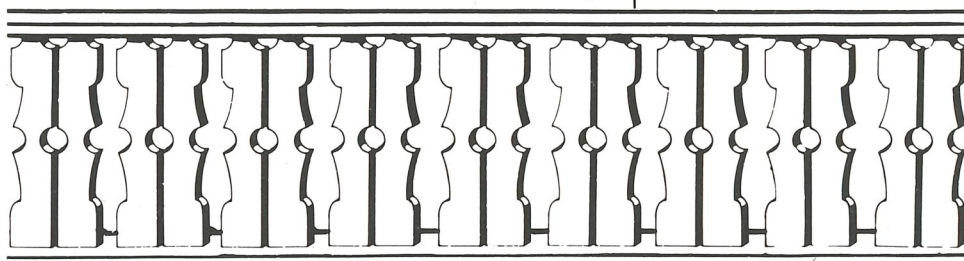

Haus-
eingangstüren

Pergolen

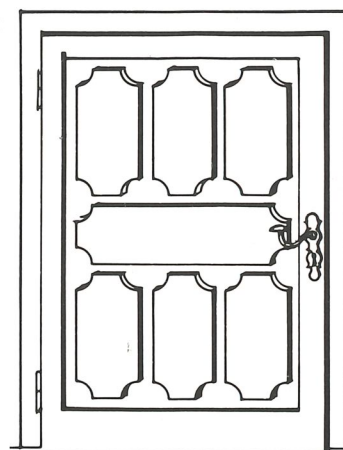
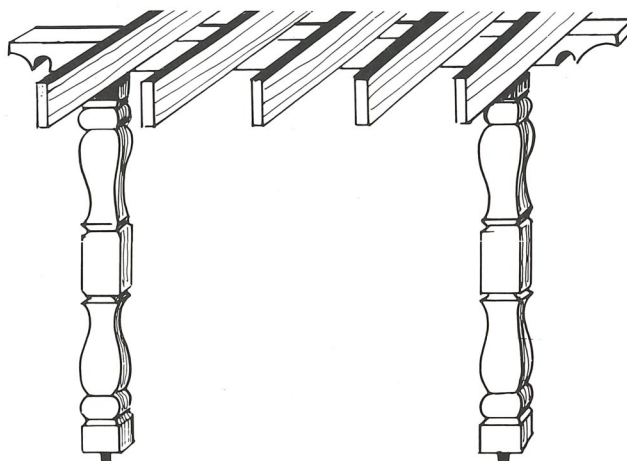

Gartenzäune

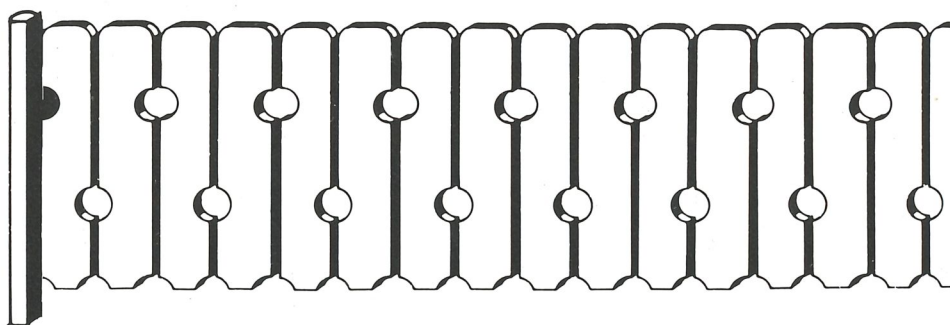

Sonstige Holzwaren

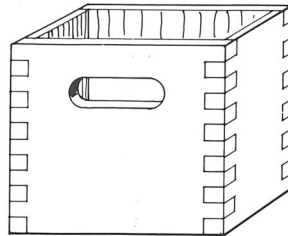
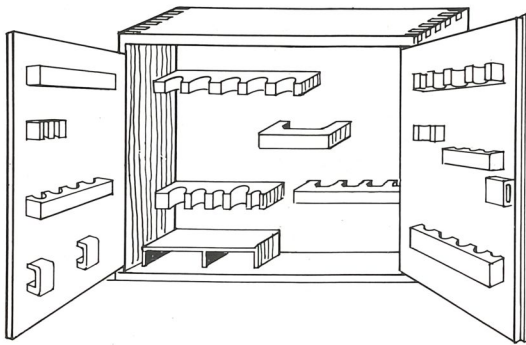

**Werkzeug-
Hängeschränke**

Materialkisten

Hängelampen

Stehlampen

Kerzenständer

Flaschenregale

Rodelschlitten

Garderoben

Holzkämme

**Bänke für
Parkanlagen**

Schatullen

Sportgeräte

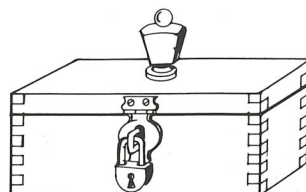
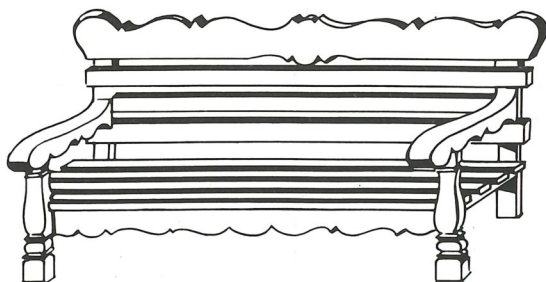
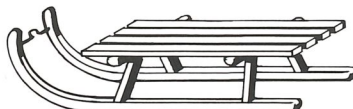
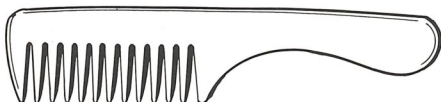
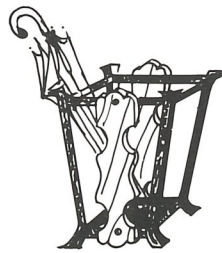
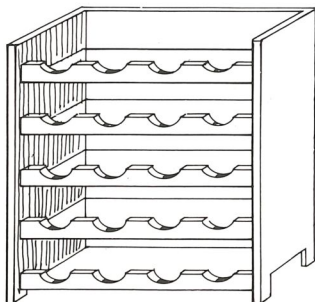
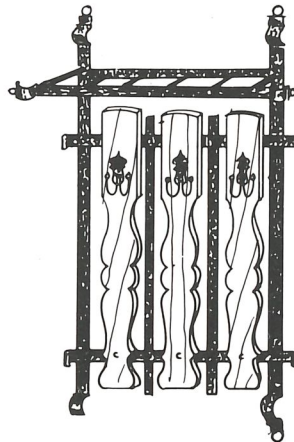
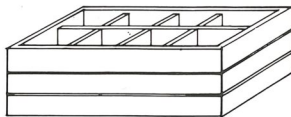
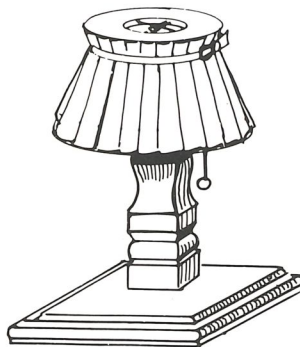
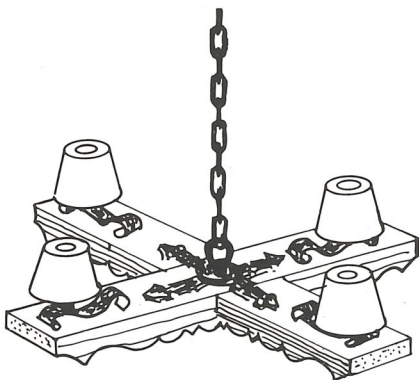

Bearbeitungsbeispiele

Fingerzinken
fräsen

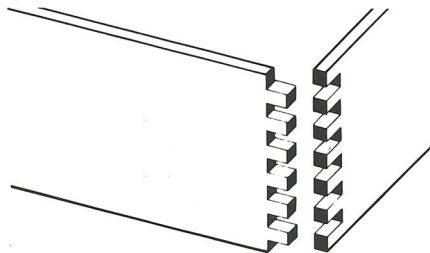

Keilzinken
fräsen

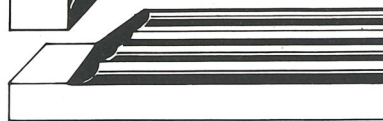

Gehrungen
fräsen

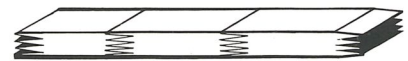

Ein- und
zweiseitig
ausklinken

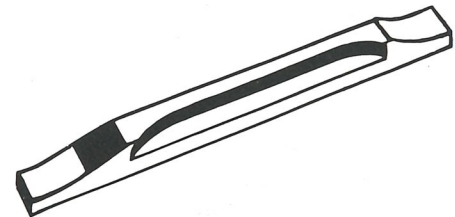
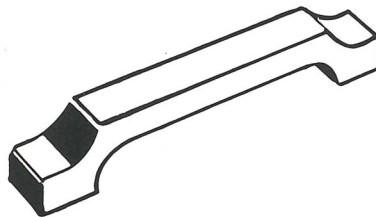

Verdeckte Zapfen
fräsen

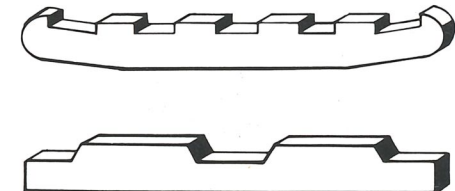
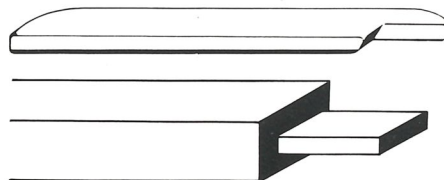

Zwei- bis
achtseitige
Ausfräsungen

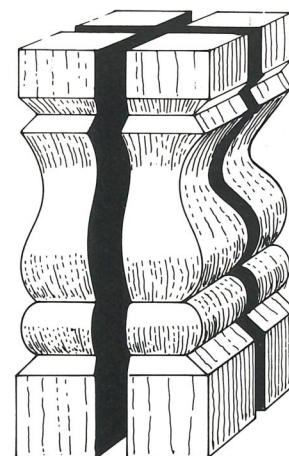
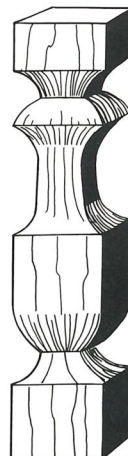

Viergeteilte
Baluster
fräsen

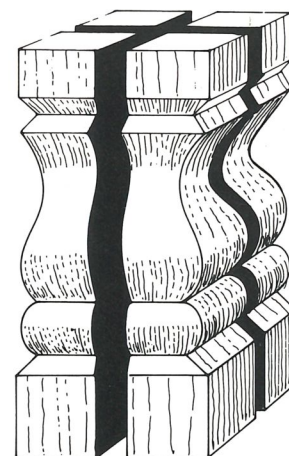
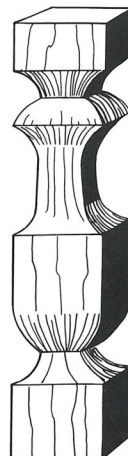

Werkzeugauswahl

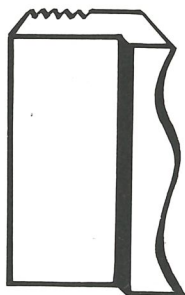
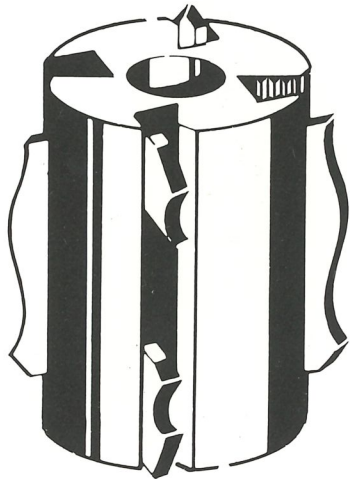

HOLZ-HER SECUR-Fräskopf, Frästiefe max. 30 mm

Wegen des günstigen Anschaffungspreises eignet sich der HOLZ-HER SECUR-Fräskopf besonders bei umfangreichen Profilvarianten und kleineren Stückzahlen. Optimale Sicherheit durch Zahnung am Messerrücken und durch Fräskopfnute. Die Aufteilung der Profilform ist durch vier Messernuten möglich.

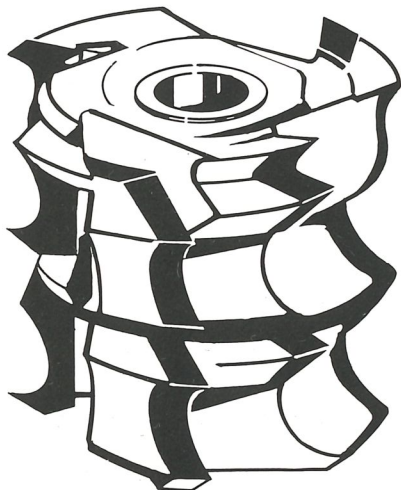

HOLZ-HER Kompakt-Profilfräsersatz, Frästiefe max. 65 mm

Bei großen Werkstückserien und Fräsarbeiten über 30 mm Frästiefe ist der Kompakt-Profilfräsersatz erforderlich.

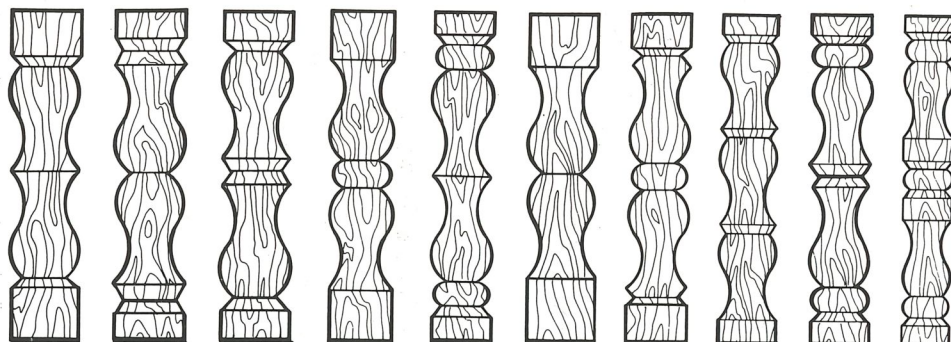

Beispiel für die Anwendung vom HOLZ-HER Kompakt-Profilfräsersatz Nr. 1

Die Wirtschaftlichkeit eines Fräswerkzeugs kann je nach Profilform bereits vor der Werkzeugherstellung entsprechend berücksichtigt werden. Sie ist dadurch gegeben, daß die verschiedenen Profilvarianten durch Hinzufügen oder Weglassen von Kompaktfräser- bzw. Profilmessersegmenten, durch Umschlagen der Werkstücke und Veränderung der Anschlagpunkte erzielt werden.

Weitere Standardprofile siehe HOLZ-HER Standard-Fräswerkzeuge.

HOLZ-HER[®]

REICH Spezialmaschinen GmbH
Postfach 1803 · D-7440 Nürtingen
Telefon (07022) 702-0 · Telex 7 267 318 rsmn d