

The standard for modern cabinet makers

# AURIGA



**NOW NEW –  
corner rounding up to 60 mm**

PRODUCTIVITY AND PRECISION



## Top features for maximum productivity

The AURIGA series offers high tech in minimum space and concentrates on the significant aspects for high quality edgebanding. The series is designed for workpiece thicknesses of up to 60 mm and edging thicknesses of up to 6 mm. High performance jointing and copying units increase the processing range for the AURIGA series. The above-average productivity and top features make this series the best in its class.

- Stable, welded base frame with noise abatement hood in equipment area.
- Ergonomic control positioned directly in entry area.
- As of the AURIGA 1304 model, the machines have a premilling unit with two cutting motors and adjustable linear guide in the entry area. Also available without premilling unit, if desired.





- Highly flexible glue application with **Glu Jet** Hybrid Technology as standard feature on all models.
- Diamond tipped cutters with integrated chip removal as well as precise concentricity and long tool life as standard features.
- High performance equipment for perfect edging finish.
- Clean and perfect edge processing.

Illustrations may contain optional features.



## Superior competency for edgebanding

Focusing on essential features, the HOLZ-HER edgebanders combine compact design with a high degree of automation, making HOLZ-HER the standard for modern cabinet makers.



## AURIGA 1303 | 1304

- With or without premilling unit, as required.
- Two finishing units included as standard features.
- Workpiece thicknesses up to 60 mm and edging thicknesses up to 6 mm can be processed with the optional 60/6-package.



## AURIGA 1307 | 1307 XL

- Including premilling and corner rounding unit for complete processing.
- Optionally with two or three finishing units – radius scraper, flat scraper and buffing unit.
- AURIGA 1307 XL also available with spraying unit (optional).



## AURIGA 1308 | 1308 XL

- PC EdgeControl for simple programming and quick setup using NC servo-axes.
- Highest degree of automation in its class.
- NOW NEW: With touchscreen and network port (optional).



Optional motor-driven pressure bridge adjustment

# High standards guarantee your investment for the future

The HOLZ-HER Edge Control PPC 221 and PPC 231 (AURIGA 1308 | 1308 XL) provide extremely high performance making them a paragon for simple operation. A high-end industrial PC with generous features is included. Set-up and conversion of the machine has never been so rational.

## Monitor

- VGA color monitor PPC 221 (standard) or 15" touch screen (PPC 231) (optional).
- Graphic user interface, all information displayed in plain text and/or graphic form.
- Simple operation – rotating and swiveling control panel at eye height.
- Dust-proof foil keypad – protects PC for long service life.
- LED display for unit selection.

## Program list

- Programs are simple to call with program names and numbers.
- Large program memory for all desired applications.
- Individual selection of units with the functions as basic setting possibilities for nominal values, path points and tool corrections.
- Set-up processes for units and their axis settings carried out centrally and clearly by fine adjustment to 1/100 mm (depending on equipment).

## Integrated path control

- Interval display for shortest workpiece distance.
- Path points are controlled generally or in a program-specific manner.
- Clear and complete acquisition of all operating data: Total running meters, total number of parts, total number of hours, as well as running meters, quantity and time per program with reset function.
- Service reports in plain text.
- Integrated synchronous bus system for high accuracy unit control.
- Individual management for up to ten users with password protection and individual authorization.

## Equipment/service

- Network connection (optional).
- Online maintenance (optional), rapid exchange of data with HOLZ-HER service department.
- Barcode interface (optional).
- Connection to HOLZ-HER process data acquisition (HHPDE) system for direct read-out of operating data.





## We know what you need: the AURIGA control

With their clearly arranged control, the AURIGA 1303 | 1304 | 1307 | 1307 XL models are quick and easy to operate.

- The HOLZ-HER **Glu Jet** System is equipped with precise temperature control for glue application over two heating circuits.
- Simple magazine switch-over from strips to coil edging.
- End trimming unit can be switched off for pointed or angled work.
- End trimming unit can be pivoted pneumatically from the control panel.
- Cutting unit can be switched over pneumatically from flush to radius milling or can be completely extended and retracted pneumatically (optional).
- Selection switch for optional glue scraper (ON/OFF).
- Selection switch for automatic glue replenishment.

Maximum  
operating comfort

## Highly efficient production through HOLZ-HER machine network Programming – Sawing – Edgebanding – CNC Machining

### CabinetControl (1)

- Carcass furniture at the click of the mouse.
- Automatic generation of cutting lists and CNC programmes.

### Rational and precision sawing (2)

- Perfect cutting results.
- Mature optimization software.
- Optimum sawing cycle.

### Intelligent edgebanding (3)

- Program selection at the touch of a button.
- Alternative: fully automatic with barcode.

### Perfect data flow (4)

- Program information also via data matrix barcode.

### Effective CNC performance (5)

- Automatic program call with barcode.
- Variable programming with CAMPUS Software.
- Perfect cutting results.



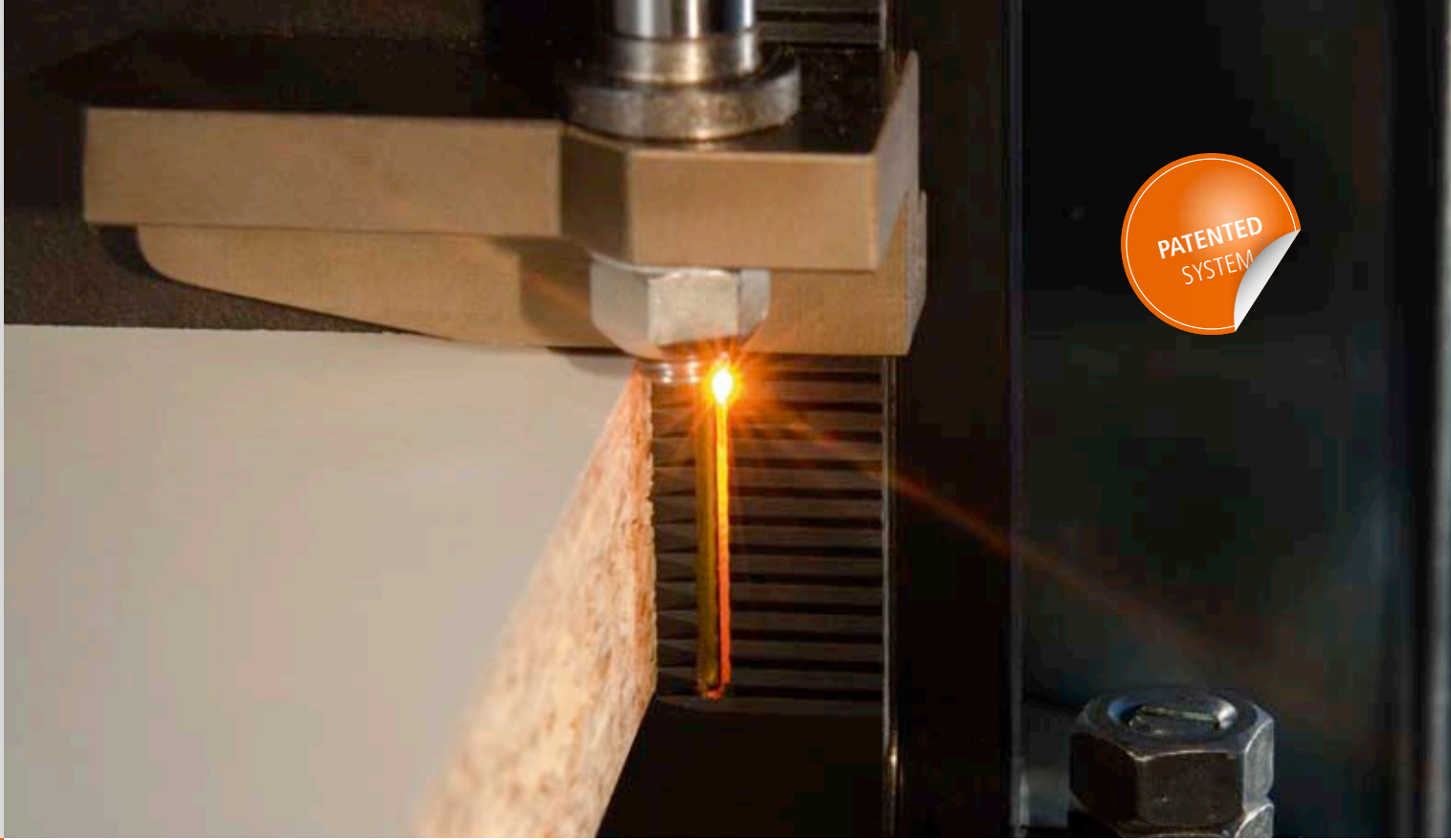

## GLUE APPLICATION SYSTEM

# Hybrid technology – two perfectly combined systems

The edgebander is decisive for furniture with a high quality appearance. You can also profit from 45 years of HOLZ-HER technological leadership in edgebanding.

- Change over from colored to neutral glue at the flick of the wrist.
- Cartridge or granular form (Figs. 1 and 2) – the glue can be changed over in minutes.
- Change over from EVA to PUR glue is also possible within the shortest time.
- And the entire system can also be completely cleaned in just minutes.



Heat-up time only 3 minutes





# Glu Jet – Zero joint with thin film technology

Ultra-thin glue joints, easily equivalent to industrial laser edges, are easy to achieve with the HOLZ-HER **Glu Jet** System, which also offers unrivaled flexibility.

The clear advantages of the hybrid technology in combination with the new HOLZ-HER thin film technology, make this gluing system the all rounder for craftsmen and industrial users. Visual zero joints with PUR glue - allowing use in wet area - are only natural for HOLZ-HER customers.

Reliability, quality and experience - backed up by HOLZ-HER's three year warranty on its patented **Glu Jet** nozzle system.

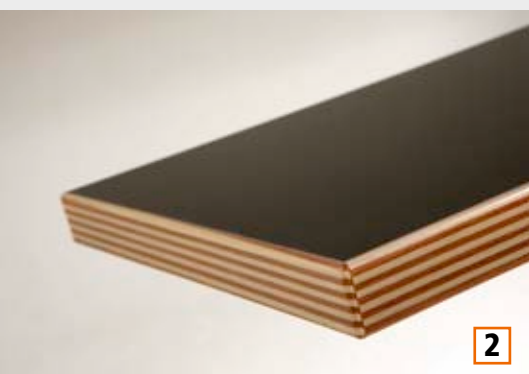
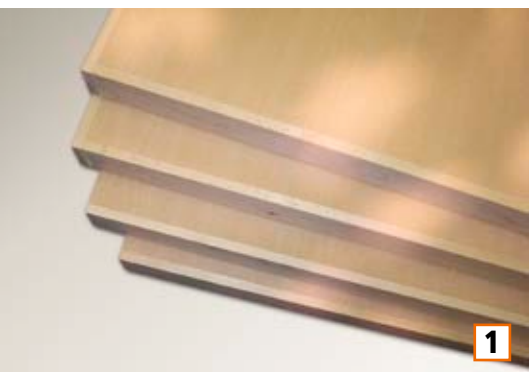
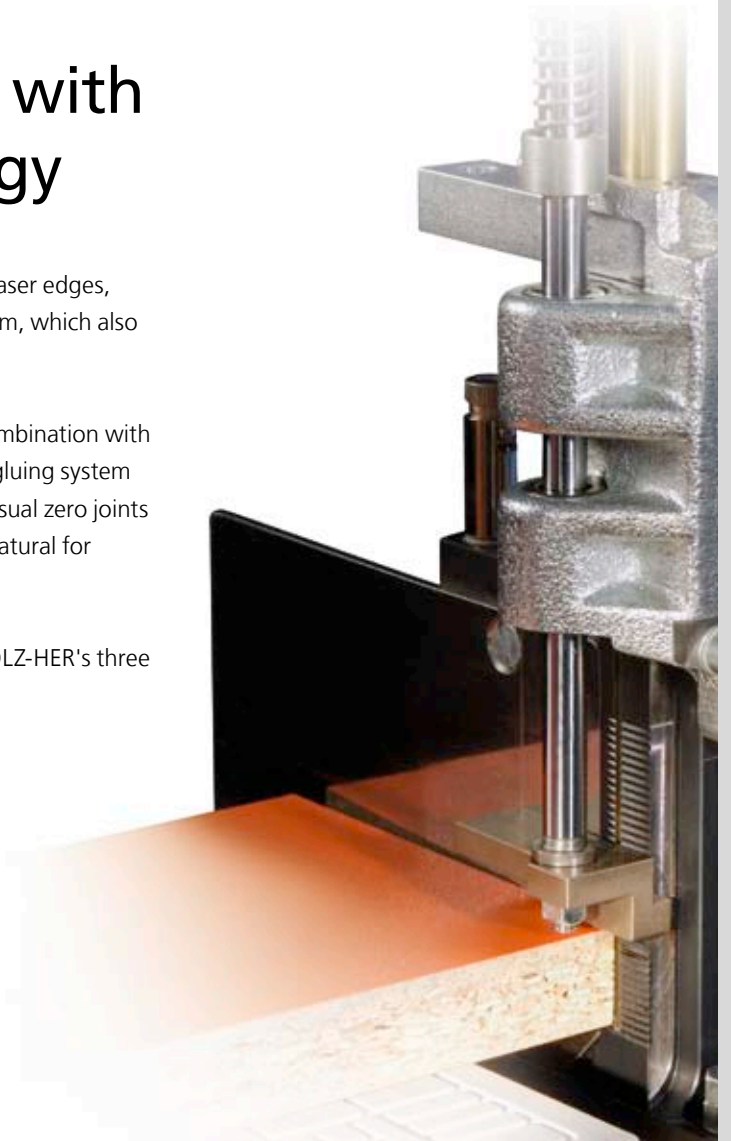

## Superior appearance for all materials

Starting with the state-of-the-art, high gloss edging right up to solid wood edging with cross section of 6 x 65 mm, HOLZ-HER remains unequalled for variety.

HOLZ-HER sets the trends for tomorrow today.

- Solid wood edging (Fig. 1)
- Veneer edging
- Plastic edging (Fig. 2)
- Aluminum edging
- Formica edging
- Melamine resin edging
- and many others

# Perfect edgebanding

AURIGA units offer a convincing range of performance. From premilling unit, edge feeder, unequalled HOLZ-HER glue application system, and end trimming and cutting units all the way to the custom equipment in the finishing area, ten high performance modules are available for perfect edgebanding.

## Corner rounding

Corner rounding unit for processing corners with edging thicknesses up to 3 mm. Tools for radiuses up to 3 mm and chamfers up to 45 degrees –postformed profiles possible.

- Diamond tipped tools for long tool life.
- Integrated chip removal in tool.

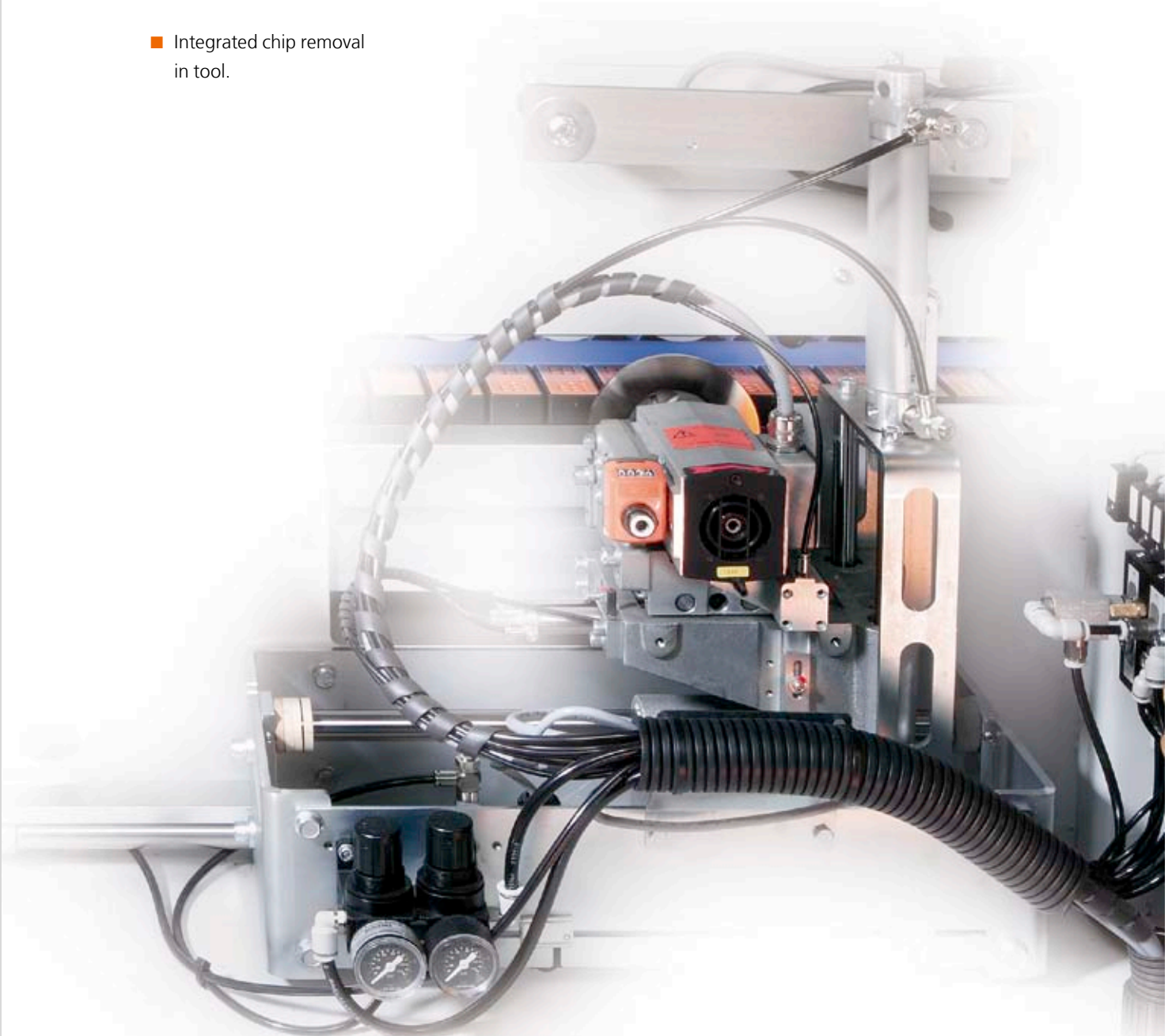



## Premilling

Cut edges often have small tears in the top layer. The premilling unit ensures perfect panel surfaces and prepares the panels for the gluing process. Equipped with quick-change flange ProLock.

Including height adjustment for optimum utilization of cutters.

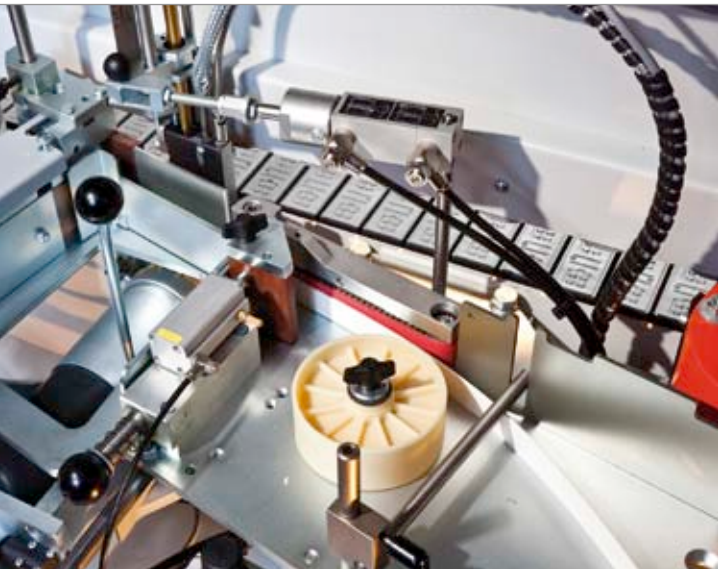
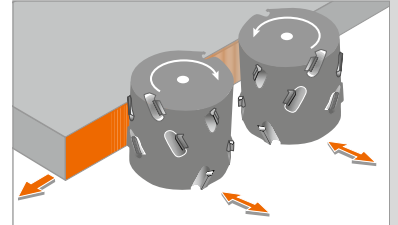

## Edge feeder

Fully automatic, user-friendly feed of strips and coiled edging; conversion without tools.

Gentle material handling with transport belt for edging transport and light barrier for edging recognition.

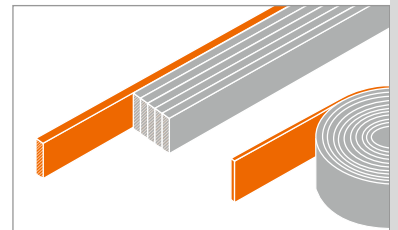

## Pressure unit

High quality 3-roller pressure unit for pressing edging against panel cleanly and forcefully. First roller with motor drive and pneumatic application control. Two conical subsequent pressure rollers.

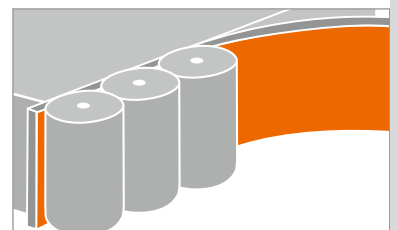



### Pneumatic end trimming unit

For straight or chamfered end trimming on thin edging; a standard feature allows this unit to be pivoted to 10 degrees pneumatically. High quality version with stable cast iron pillars.

Each saw motor mounted on two guides for precisely trimming off protruding edging.

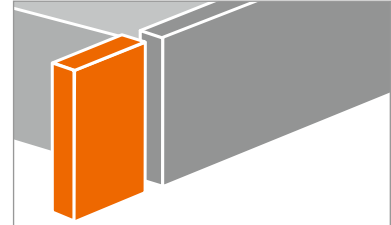

### Pneumatic cutter unit

Multifunction cutter unit for flush cut on edging with thickness up to 6 mm, radiuses up to 3 mm, pivots 0 – 5 degrees. Including diamond tools.

Further equipment:

- Integrated chip removal in tool.
- ProLock system.

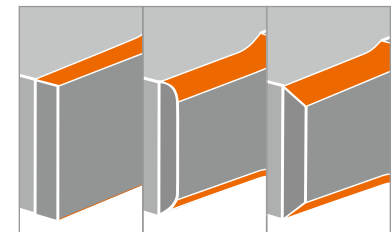

### Corner rounding unit

Unit for copying vertical, end edges, various edge profiles possible – including postformed profiles. Integrated chip removal. With diamond tipped tools for long tool life.

NOW NEW: With 60 mm operating height for AURIGA 1308 and 1308 XL.

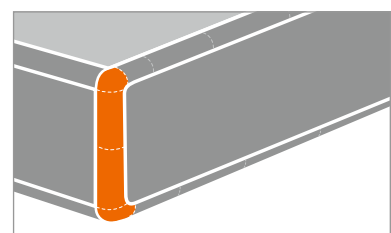



## Finishing

Perfect finishing – generous post-machining area for up to three finishing units (depending on model).

### ■ Scraper unit

For perfect smoothing of radiuses and chamfers on plastic edging.

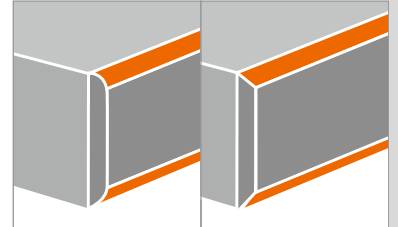

Also available with two NC servo-axes (optional for AURIGA 1308 and 1308 XL) (Fig. 1).



### ■ Buffing unit

Polishing for maximum gloss; for complete finishing (Fig. 2).

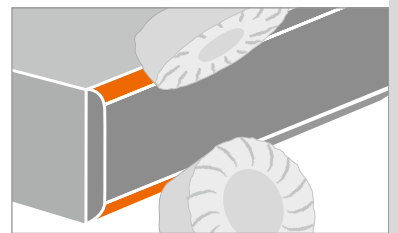

### ■ Glue scraper

The application-controlled glue scraper removes all glue residues, which are then blown off the panel by the integrated blow nozzles (Fig. 3).

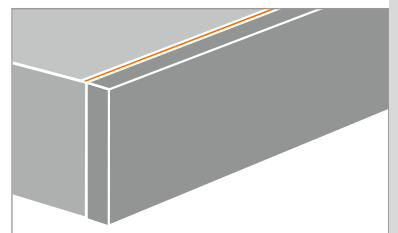

## Front and rear spraying units

A release agent is sprayed on to a precisely defined area by special spray nozzles in the entry area. This prevents any glue or contamination residues from adhering. These glue and contamination residues are removed reliably by the spraying unit (for cleaning agent) in the discharge area in combination with the buffing unit (available as option for AURIGA 1307 XL and 1308 XL).

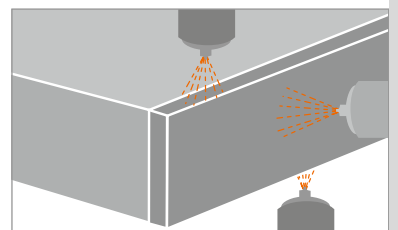





# Overview of AURIGA series

Machine	AURIGA 1303	AURIGA 1304	AURIGA 1307	AURIGA 1307 XL	Options
Control	Compact control	Compact control	Compact control	Compact control	
Bridge	Manual	Manual	Manual	Manual	
Edge feeder	Autom. for strips and coiled edging up to 6 mm	Autom. for strips and coiled edging up to 6 mm	Autom. for strips and coiled edging up to 6 mm	Autom. for strips and coiled edging up to 6 mm	
Premilling	x	45 mm*	45 mm*	45 mm*	* 60 mm
Glue application	<b>Glu Jet*</b>	<b>Glu Jet*</b>	<b>Glu Jet*</b>	<b>Glu Jet*</b>	* Granule and/or cartridge hopper
Pressure unit	3 Pneum. rollers incl. conical subsequent pressure rollers	3 Pneum. rollers incl. conical subsequent pressure rollers	3 Pneum. rollers incl. conical subsequent pressure rollers	3 Pneum. rollers incl. conical subsequent pressure rollers	
End trimming	Single motor 45 mm* pneumatic pivoting feature	Single motor 45 mm* pneumatic pivoting feature	Single motor 45 mm* pneumatic pivoting feature	Two-motor 60 mm pneumatic pivoting feature	* Two-motor 60 mm
Cutting	Multi-function 6 mm*	Multi-function 6 mm*	Multi-function 6 mm*	Multi-function 6 mm*	* Multifunction pneum. 6 mm; pivots 0° – 15°
Corner rounding	x	x	45 mm	45 mm	
Scraper	Mechanical* incl. chip collection box	Mechanical* incl. chip collection box	Mechanical* incl. chip collection box	Mechanical* incl. chip collection box	* Pneumatic
Glue scraper	Instead of buffing unit*	Instead of buffing unit*	Instead of buffing unit*	Application controlled incl. blow nozzles	* Application controlled incl. blow nozzles
Buffing	Buffing unit	Buffing unit	Buffing unit	Buffing unit	
Spraying device	x	x	x	*	* Parting and cleaning agent

## TECHNICAL DATA

	AURIGA 1303	AURIGA 1304	AURIGA 1307	AURIGA 1307 XL	AURIGA 1308	AURIGA 1308 XL
<b>Machine dimensions</b>						
Overall length (mm)	3,917	3,917	4,630	4,930	4,630	4,930
Weight (kg)	930	1,055	1,250	1,420	1,250	1,420
<b>Feed speed</b>						
Feed speed (m/min)	10	10	10	10	10	10
<b>Working dimensions</b>						
Minimum workpiece length (mm)	160	160	160	160	160	160
Workpiece thickness (mm)	6 – 45 (60)	6 – 45 (60)	6 – 45 (60)	6 – 60	6 – 60	6 – 60
Edge thickness (mm)	0.4 – 3 (6)	0.4 – 3 (6)	0.4 – 3 (6)	0.4 – 6	0.4 – 6	0.4 – 6

Machine	AURIGA 1308	AURIGA 1308 XL	Options
Control	PC Edge Control*	PC Edge Control*	* Touchscreen with network port
Bridge	Manual*	Manual*	* Motor-driven
Edge feeder	Autom. for strips and coiled edging up to 6 mm	Autom. for strips and coiled edging up to 6 mm	
Premilling	45 mm*	45 mm*	* 60 mm
Glue application	<b>Glu Jet*</b>	<b>Glu Jet*</b>	* Granule and /or cartridge hopper
Pressure unit	3 Pneum. rollers incl. conical subsequent pressure rollers	3 Pneum. rollers incl. conical subsequent pressure rollers	
End trimming	Two-motor 60 mm pneumatic pivoting feature	Two-motor 60 mm pneumatic pivoting feature	
Cutting	Multifunction pneum. 6 mm*, pivots 0° – 15°	Multifunction pneum. 6 mm*, pivots 0° – 15°	* MOT 4 pneumatic pivot feature
Corner rounding	60 mm	60 mm	
Scraper	Pneumatic* incl. chip collection box	Pneumatic* incl. chip collection box	* MOT 2
Glue scraper	Instead of buffing unit*	Application controlled incl. blow nozzles	* Application controlled incl. blow nozzles
Buffing	Buffing unit	Buffing unit	
Spraying device	x	*	* Parting and cleaning agent

	Optional
	Standard:
	Not possible
	Free space

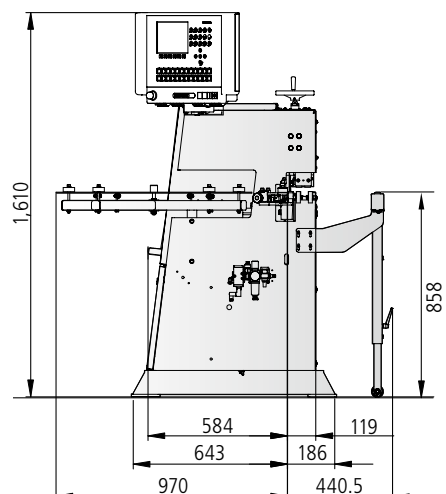
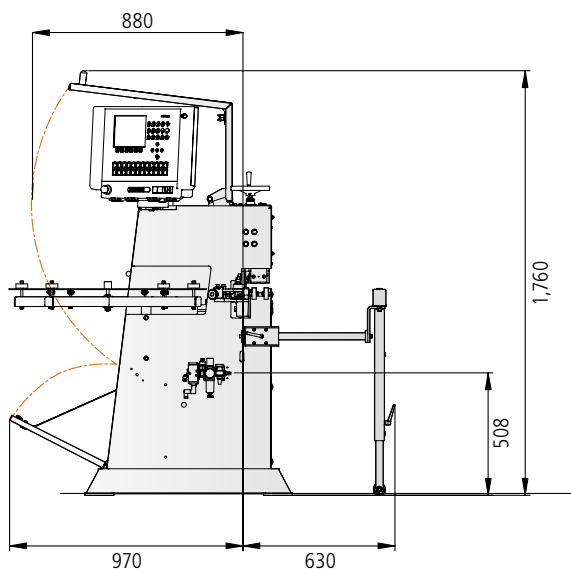

Product brochures and many  
videos are available at  
[www.holzher.com](http://www.holzher.com)



The technical data specified is intended for reference only. HOLZ-HER woodworking machines are subject to constant development and are therefore subject to modification without prior notice. The illustrations are therefore not binding. Some of the machines shown also contain special equipment not included as a standard feature. For clarity, some of the machines are shown without protective hood.

Picture credits: © istock | lisegagne

**UK** – HOLZ-HER 3130 25 – Printed in Germany/Imprimé en Allemagne  
Printed on: 23.04.2012 – First edition: 12.03.2012

Your authorized HOLZ-HER dealer



**HOLZ-HER GmbH**  
D-72622 Nürtingen

Tel.: +49 (0) 7022 702-0  
Fax: +49 (0) 7022 702-101  
[www.holzher.com](http://www.holzher.com)