

More Units. More Efficient Production.

HE HOMAG

Our edge banding machines

EDGETEQ S-500 | S-500 profilLine
LOOPTEQ Return Conveyors

YOUR SOLUTION





Perfect edges for discerning customers manufactured with flexible machines

Individual customer needs and preferences, sophisticated products and a wide range of materials – all factors which play a major role in today's woodworking industry. Here, production flexibility and efficiency are key – particularly for woodworking shops and medium-sized enterprises.

This is what the innovative generation of HOMAG edge banding machines EDGETEQ S-500 especially aims at: offering more equipment and therefore even higher flexibility.

YOUR SOLUTION

[MORE: HOMAG.COM](https://www.homag.com)



CONTENT

- 04 Highlights
- 06 Material types | Edge parameters | LOOPTEQ return conveyors
- 08 EDGETEQ S-500 | Technical data
- 12 Modular range of units
- 38 2-profile technology | 3-profile technology
- 40 powerTouch2
- 42 Software
- 43 tapio
- 44 LOOPTEQ return conveyors
- 52 Production lines
- 54 HOMAG LIFE CYCLE SERVICE

Benefits of the EDGETEQ S-500

- **More flexibility thanks to the enhanced units**

The MS40 multi-stage trimming unit, the MF60 Servotrim multifunctional profile trimming unit and the MN11 profile scraping for two profiles are now available for the EDGETEQ S-500 and offer even more possibilities for individual requirements.

- **Easy processing of PUR**

If requested, PUR, EVA and airTec can be processed on one single machine.

- **Higher availability and shorter setup times of the machine**

With the AG12 and AG12 Basic gluing units the application unit for hot melt glue can easily be purged in the machine.

- **Less cleaning and more safety**

Pneumatic dosing gates at the application unit for hot melt glue close automatically, avoid contamination and reduce the effort required for cleaning e.g. in case of power failure.

- **Increased cost efficiency**

The unit combinations, such as 2-profile or 3-profile technology, optimally adapt to your requirements.

- **Extendability**

Due to the drilling grid the machines can be extended more easily and offer even greater investment security.

- **EDGETEQ S-500 profiLine**

The profiLine machines offer even more configuration possibilities and an enormous flexibility.

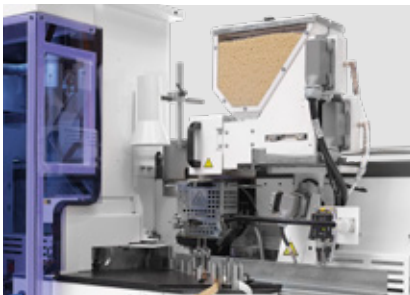

Gluing units – safe hot-melt glue application

HOMAG gluing units are qualified for quick, friction-locked gluing. The heated glue roller provides an optimum glue temperature. Standard is an EVA pre-melting unit.



Edge banding with PUR

PUR adhesives are used by HOMAG on the same machines and with the same application units as EVA hot melt adhesives.

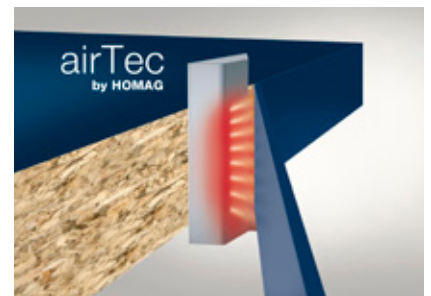

Zero joint technology with HOMAG airTec

The units are now equipped with a rotary air heater which makes the process significantly more efficient and quieter as well as saving resources.

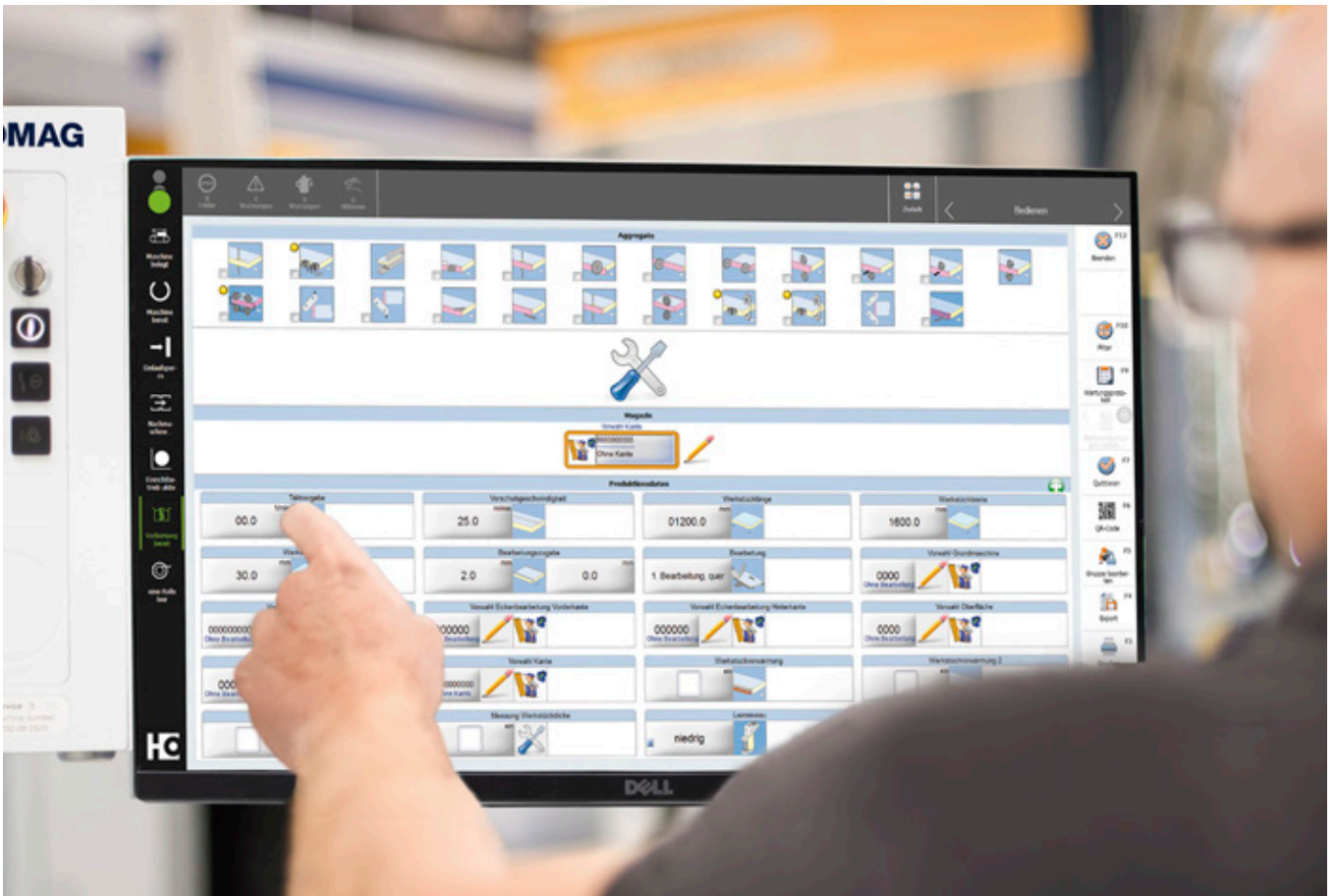

Intuitive operation with powerTouch control system

Using the widescreen format multitouch monitor, you control machine functions by direct touch contact. The ergonomically optimized design and an array of help and assistant functions substantially simplify operation.



Belt-type top pressure

The top pressure beam made of steel with double V-belt forms the basis for outstanding quality, as it ensures that workpieces are ideally clamped for processing.



Multi-stage technology

For easy profile change by push button. Saves time and improves quality.



Controlled chip capture

The chips are extracted already in the interior and selectively directed to the extraction hood. Greater economy and a longer service life due to reduced wear and lower service costs. Reduced extraction speed drives down energy consumption and costs.



Material types | Edge parameters

High flexibility is achieved as all edge materials can be processed: 0.3 mm melamine, up to 3 mm ABS, PP, PVC and wood as coil material. Solid wood strips and veneer strips up to 12 mm are fed in individually and up to 20 mm from the package. Furthermore even veneer strips of up to 1 mm can be fed from the package.

For perfect high-gloss parts, important components such as the motor-driven top pressure and the automatic adjustment of the glue joint scrapers are used. Special tracing elements are ideal for processing of acute-angled or obtuse-angled parts or parts with hinge holes and transversal grooves.

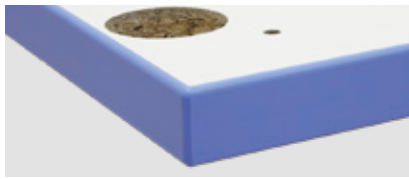
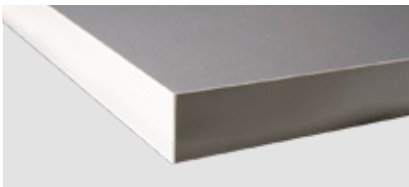

		a	b	c	d	e
	SOLID (mm)			0.4 – 12.0 (0.4 – 20.0 option)		
	COILS (mm)		with b = 22: min. 60 with b = 40: min. 105	8 – 60/ 12 – 60	0.3 – 3.0	65 max. 25
	STRIPS (mm)				0.4 – 1.0	



LOOPTEQ return conveyors for increased productivity

Workpiece return conveyors of the LOOPTEQ series are the ideal addition to the machines of the EDGETEQ series. In one-man operation, the panel return flow is optimized and allows a lean and efficient production process.

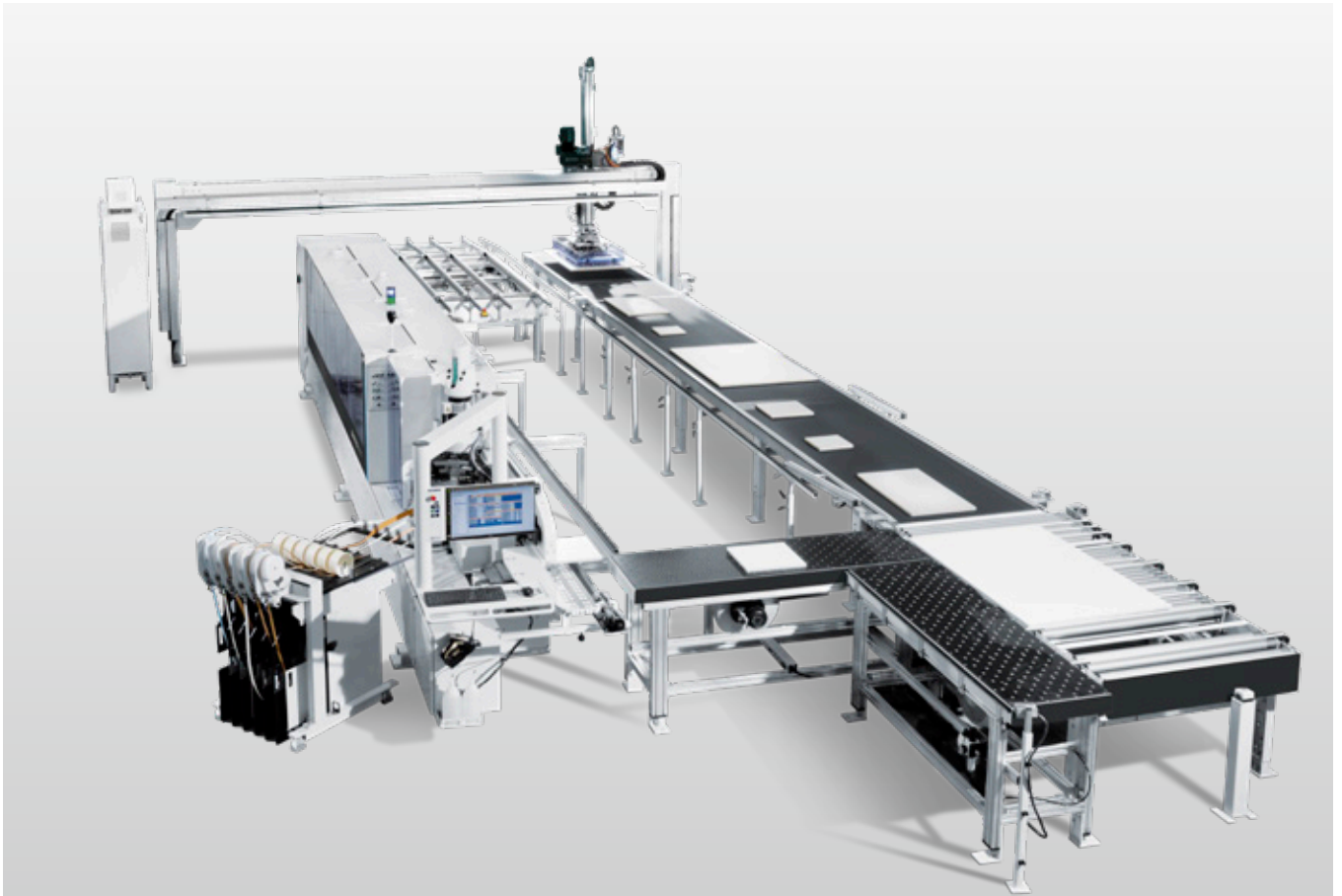

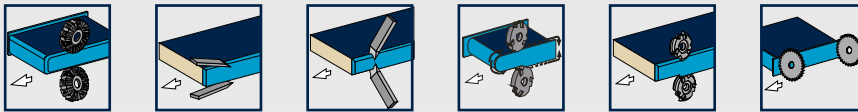
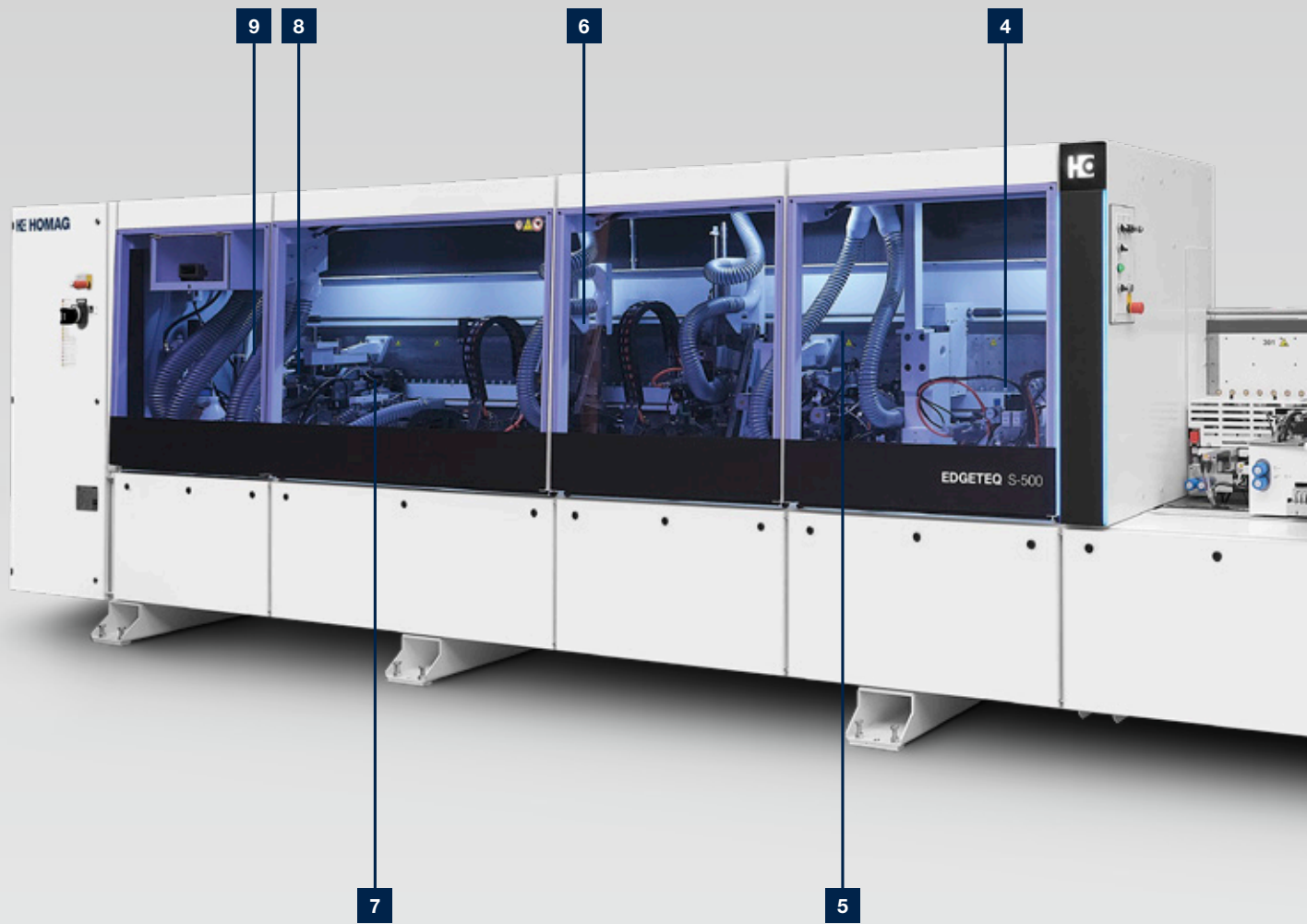

EDGETEQ S-500

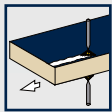
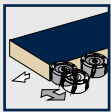
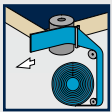
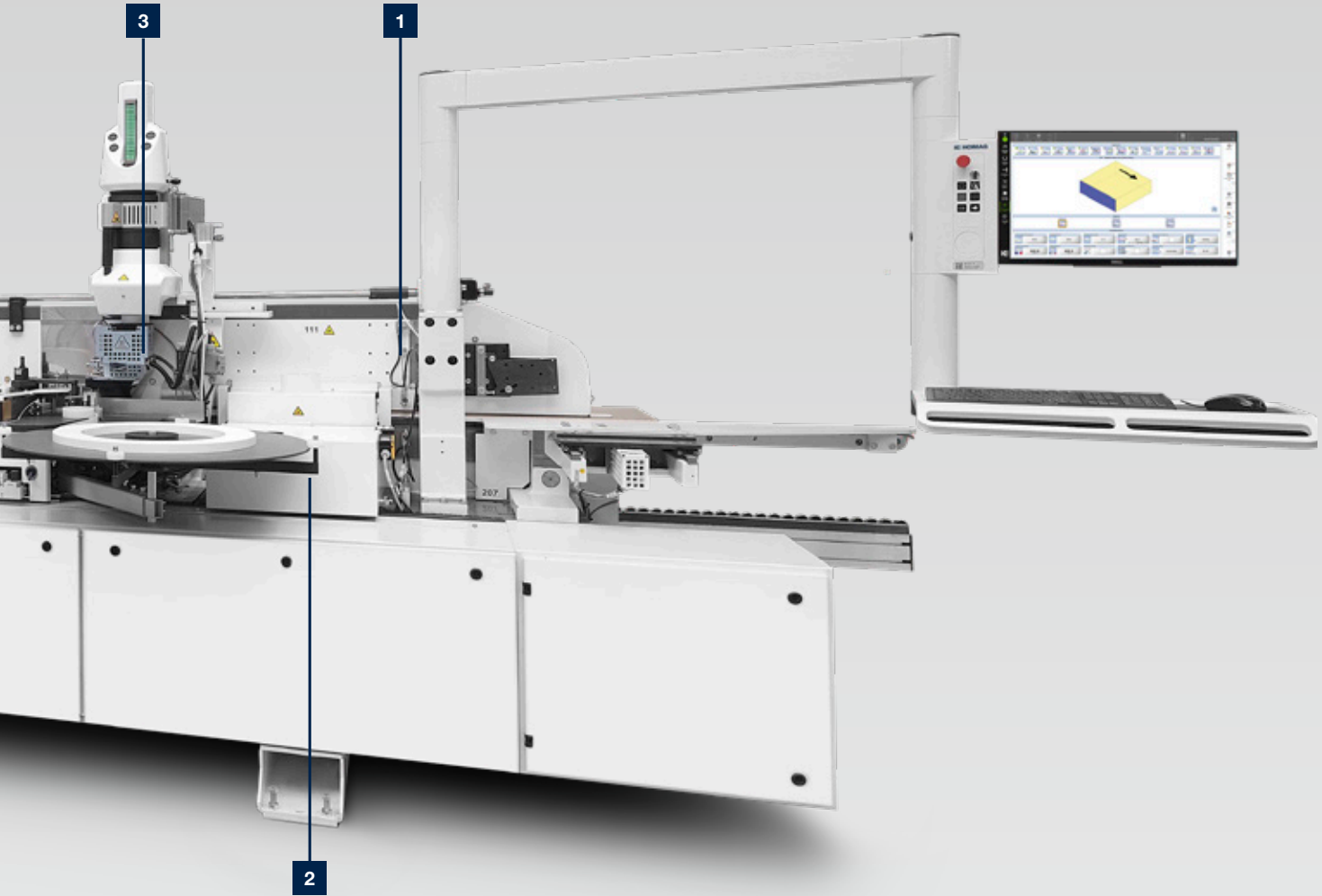

1 Separating agent spraying unit

4 Snipping unit

7 Profile scraper unit

2 Joint trimming unit

5 Multi-stage trimming unit MS40

8 Glue joint scraper

3 Gluing unit AG12 Basic

6 Multifunctional trimming unit MF60 Servotrim

9 Buffing unit

Machine configurations | Joint trimming – gluing – post-processing

- **JOINT TRIMMING.** Different adjustment possibilities and trimming tools are available for a precise joint trimming.
- **GLUING.** The purposeful use of the three gluing processes EVA, PUR and airTec provides the best possible glue joint quality with regard to price-performance ratio.
- **POST-PROCESSING.** Whether just 1 profile or the change between 2 or 3 profiles is required – there is the right solution, mostly patented by HOMAG, for every application.





MACHINE DIMENSIONS

Overall length (mm)	dependent on the equipment
Feed speed adjustable (m/min)	16 – 20, 25, 28, 30

WORKING DIMENSIONS

Workpiece width (mm)*	
with workpiece thickness 8 – 22 mm	60
Workpiece thickness (mm)	8 – 60 / 12 – 60
Edge thickness, coils (mm)	0.3 – 3
Edge thickness, strips / solid wood strips (mm)	0.4 – 12 (20)

* dependent on the workpiece thickness



Our range of modular units: The right solution no matter what the requirement

For wide-ranging different processing tasks, we use units from our tried and tested modular range. By continuously extending the offered functions, we ensure that you have the

right solution available to cope with changing trends. Their extreme precision and state-of-the-art technology will boost the flexibility and efficiency of your production.

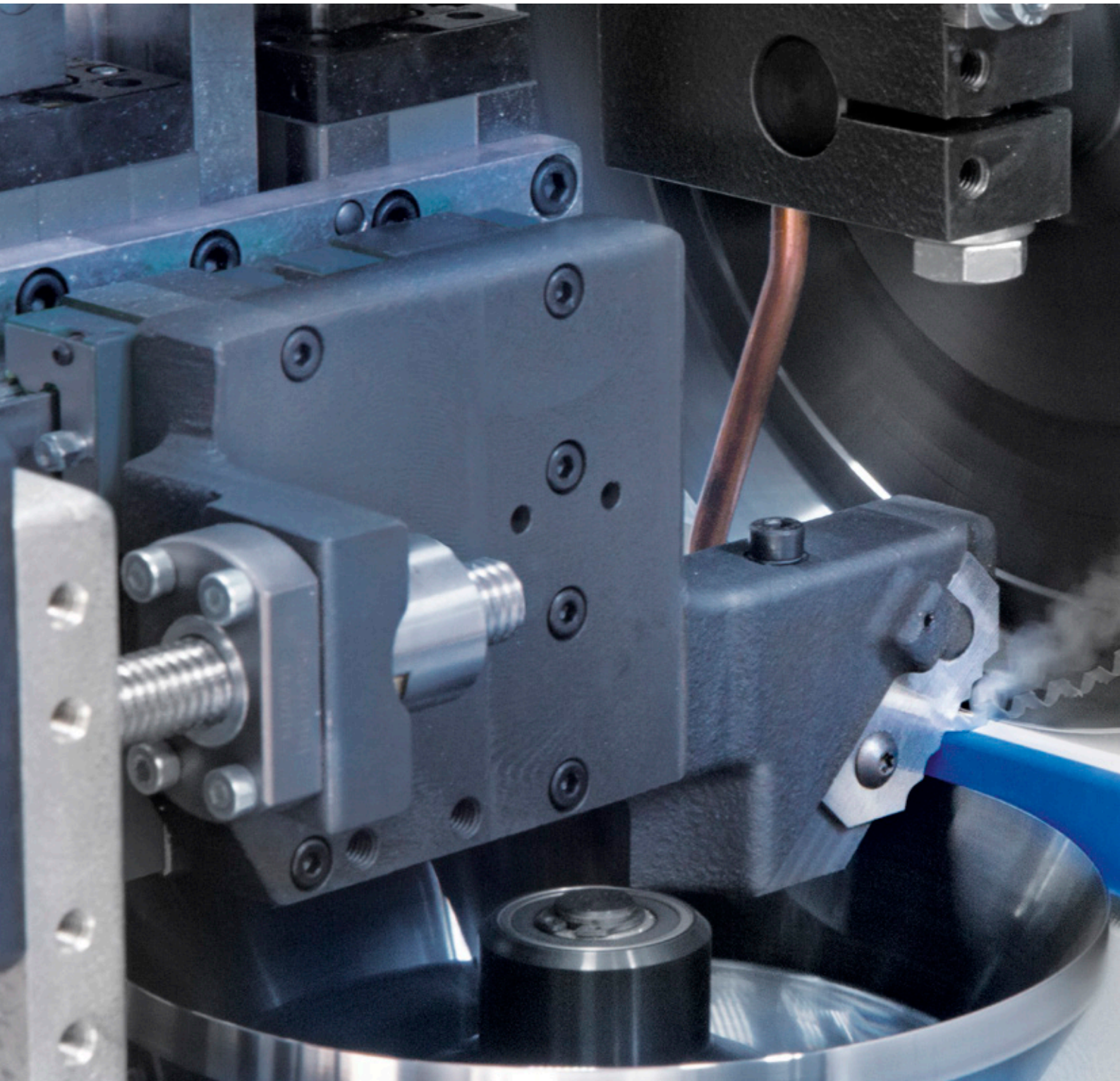

HOMAG OFFERS YOU

- Optimum trimming quality through vibration-free connection plus long tool service life due to the HSK interfaces for the finishing units
- Minimum setup times due to 3-profile technology with 4-motor profile trimming unit FF32 and automatic adjustment of the glue joint scraper
- Optimum processing of e.g. high-gloss surfaces or lightweight panels due to servo-controlled movement sequence of the multifunctional profile trimming unit MF60 Servotrim





Infeed stop

For minimum workpiece spacing and safe operation. Pneumatically controlled.

Workpiece feeding

Precise workpiece feeding is a pre-condition to achieve perfect edge quality. Our solutions are your benefit: infeed fence, infeed stop, sliding carriage or workpiece support.



Air cushion table

For easy workpiece feeding.



Infeed device

Enabling a safe infeed of the workpieces.

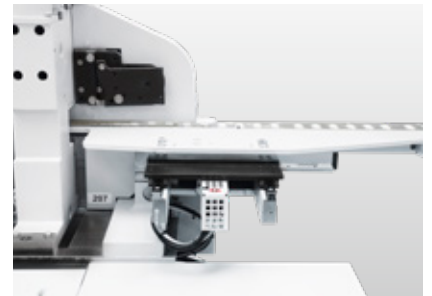

Automatic infeed fence adjustment

Program-controlled precision adjustment with precise infeed fence adjustment by means of servo axis.



Sliding carriage

Robust linear guiding system to secure rectangular workpiece feeding.



Workpiece support basic

The workpiece support can be moved up to 1,000 mm along profile rails.

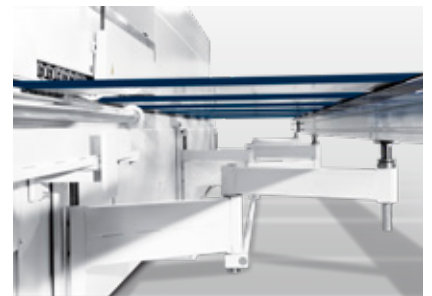

Scissor-design workpiece support

The workpiece support in scissor-design is conveniently extendable to 1,000 mm.

Workpiece infeed systems for EDGETEQ S-500 profiLine

HOMAG workpiece infeed systems guide your workpieces automatically and precisely towards the edge processing machine. In this way, you will create the basis for a high

standard of processing quality and efficient processing operations.



Workpiece infeed system WZ10

For workpieces which have already been cut to a high level of angular and parallel accuracy with their unfinished fixed measurement, we recommend using workpiece infeed WZ10. This is configured specifically for transporting pre-sized workpieces for flexible production.



Workpiece infeed system EZ14

A parallel precisely angled cut is not necessary with this workpiece infeed system. The workpieces are fed at a precise angle in the longitudinal and transverse direction.

Spraying units | Your requirement, our solution

Spraying units help to improve edge quality throughout the complete processing. Separating agent avoids that hot melt glue residuals adhere to the workpiece and antistatic agent avoids that plastic chips adhere to the workpiece.

Cleaning agent helps to easily remove glue residuals. Lubricant is applied to protect sensitive surfaces before trimming and to prevent gloss marks on the workpieces.

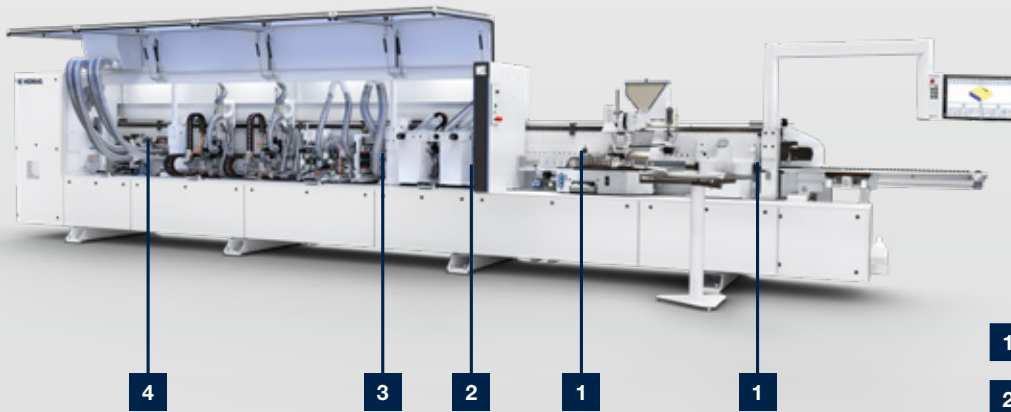

- 1 Separating agent
- 2 Antistatic agent
- 3 Lubricant
- 4 Cleaning agent

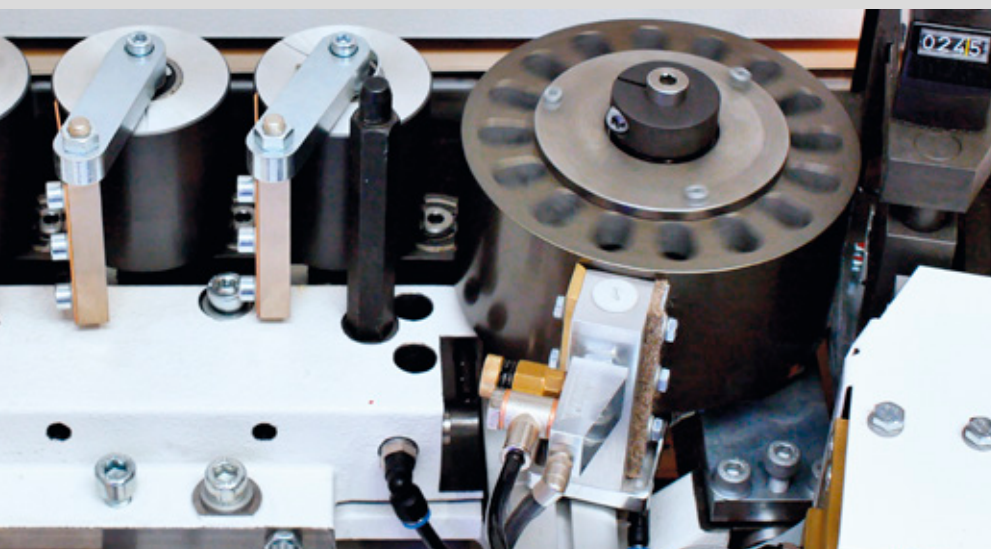

Wetting device

Separating agent application to the pressure roller keeps hot melt glue residuals from adhering.

Joint trimming unit |

Precision is the basis

The HOMAG joint trimming unit provides the perfect basis for splinter-free workpiece edges and glue joints with a consistently high standard of product quality.

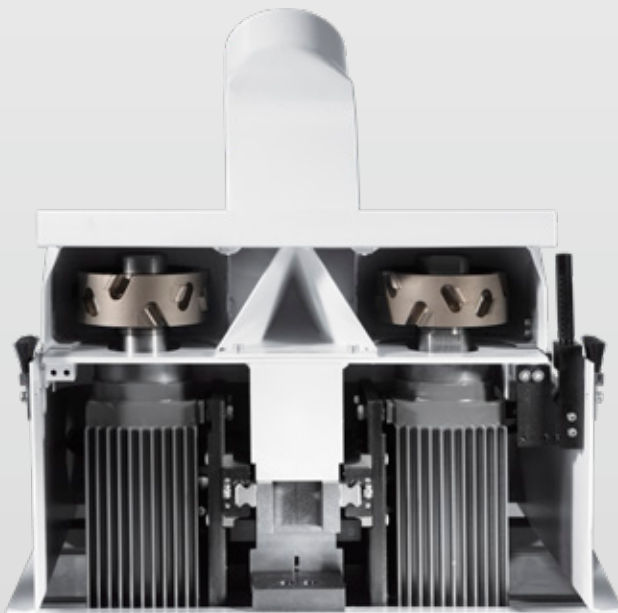

Joint trimming unit

This unit permits a high level of processing precision, is extremely hardwearing and is also designed to ensure an above-average service life. The diameter of the low-noise flying chip-optimized tool (I-system) is 125 mm (optional 150 mm).

Adjustments are performed manually or automatically.

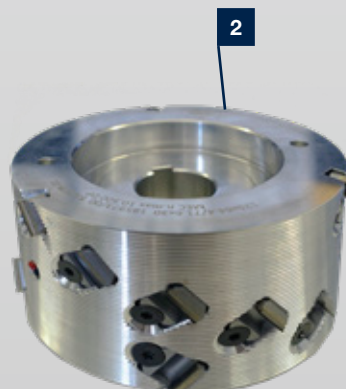
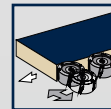

Diamond (DIA) tool

- Workpiece diameter 125 mm (optional 150 mm)
- High endurance
- Available are tools with fixed blades and changeable blades

1 Tool with fixed blades

2 Tool with changeable blades

Gluing units |

Reliable hot melt glue application

HOMAG gluing units are ideal for a fast, positive-locking glue bond. An EVA pre-melting unit comes as standard. The heated glue roller ensures an optimum gluing temperature. The magazine height adjustment permits different edge

heights to be processed with a consistent workpiece thickness. On request, the gluing unit can also be additionally equipped with a pre-melting unit – allowing rapid changeover between two different colors or different types of glue.

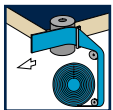
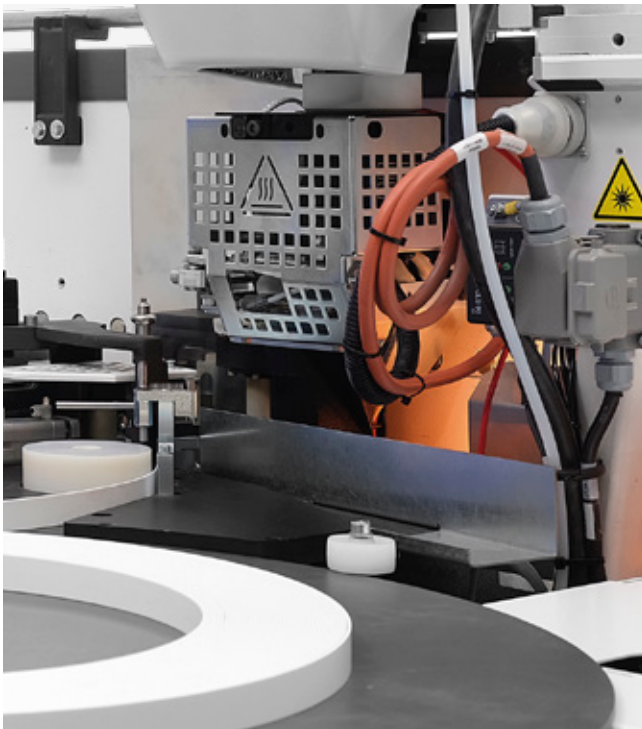

YOUR BENEFITS AT A GLANCE

- Short heating-up time by sensed level control (2 levels selectable)
- Easy removal of the application unit with quick-release lock
- Pre-melting unit for melting hot-melt glue as required either manually or automatically
- Glue roller with integrated heating guarantees constant temperature and viscosity for all workpiece thicknesses
- Electropneumatic glue roller and tank clamping prevents glue soiling on the trailing edge of the workpiece
- Tracing pad prevents wear of the application roller and ensures a consistent glue film thickness
- Glue roller lift-off on feed stop
- Emptying of the glue in the machine
- Closure of the metering slide in the event of a power failure
- Automatic cleaning cycle of the metering slide
- Universally coated application unit QA65 P for PUR and EVA



AG12 hot melt gluing unit basic version

- For processing coil material from 0.3 – 3 mm. Granulate container for storing and pre-heating hot melt granulate.
- The handling of the application unit when changing the glue and paint has been simplified and now offers the option of purging the application unit in the machine.
- Pneumatic cleaning of the glue roller and the automatic closure of the metering slide in the event of a power failure are also standard.
- An extraction hood – for both EVA and PUR processing – specifically extracts glue vapors.
- Edge heights of 12 – 65 mm can be processed on all gluing units.
- The processing of individual strips of up to 12 mm thickness is possible in the standard version.

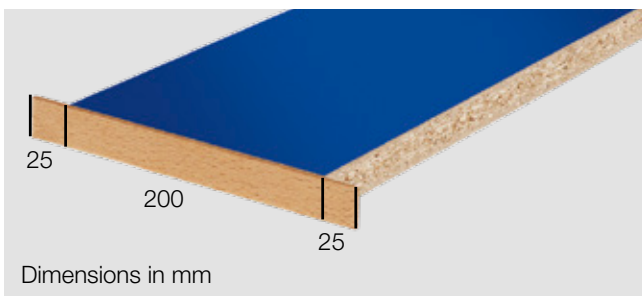

Common gluing technique

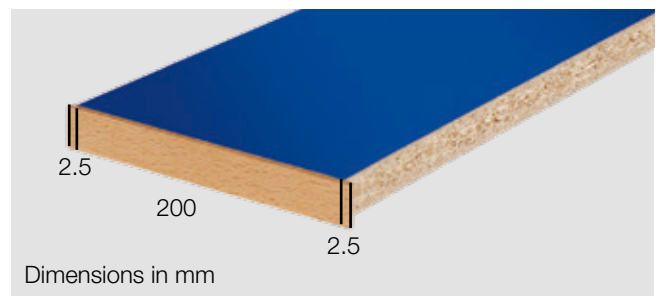

Optimized gluing technique with servo edge feed

Edge feed with a precision of +/- 2 – 3 mm at the leading and trailing edge to reduce edging material waste.

PUR glue and HOMAG | A strong alliance

The moisture and heat resistance of furniture is increased by the use of polyurethane (PUR) hot melt glue. Its use is ideal for furniture in damp areas such as bathrooms, kitchens and labs.



YOUR BENEFITS AT A GLANCE

- One application unit for all glue types
- No additional application unit needed
- Quick, friction-locked thin film application by glue roll with integrated heater



PUR pre-melting unit

- Melting output 4 kg/h
- Temperature control to prevent overheating



PUR pre-melting unit

- Melting output 6 kg/h
- Temperature control to prevent overheating



PUR pre-melting unit as ground equipment

- Different versions and combinations are available



Combination of pre-melting units for alternatively processing EVA and PUR

- Melting output up to 12 kg/h with EVA
- Melting output up to 6 kg/h with PUR



Service station

- Preheating-/ service station XES200 and cleaning station for the QA65 application unit with a storage area
- High flexibility through the use of 2 vacuum tanks, each for one QA65 application unit or an interchangeable tank for PUR melting unit up to 4 kg/h
- No vacuum pump and no nitrogen required



Vacuum tank

- Compact, mobile tank for storing the PUR application unit
- No vacuum pump and no nitrogen required

airTec | Ideal entry into zero joint technology

The airTec process has become an established zero joint solution in woodworking shops and SMEs. HOMAG's answer to the growing demand is an innovative, efficient and resource-saving airTec solution. The nerve center of the airTec unit is a rotation air heater which not only operates

with high efficiency but also with significantly lower noise emissions. airTec can be used to process all types of currently popular, laser-suitable edging types. This means great flexibility for all materials and colors.



Edge banding with “no joints”

The airTec method bonds the edging to the panel using hot air. This requires the use of special edges. These comprise a decor layer and a function layer. The HOMAG airTec unit melts the function layer at an even temperature and flow rate and bonds it perfectly to the narrow surface.

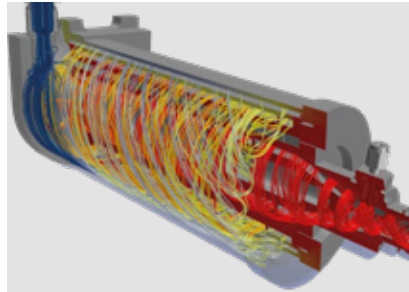

Innovative rotation air heater

The source of energy heats the air while at the same time acting as a heat store for subsequent repeated air heating. It also works with reduced air consumption and reduces heating of the surrounding atmosphere. Almost the only noise generated is emitted during the activation process, and is below the noise level of the other processing units.

BENEFITS

- Reduction of noise
- More efficient, resource-saving operation
- Even air flow for high quality
- Rapid changeover between airTec and traditional gluing technology
- Simple operation with powerTouch



Flexibility for gluing

The EDGETEQ S-500 offers three gluing processes in automatic change. As well as airTec, both EVA and PUR can be used on one machine. The respective process can be selected according to requirements. The change from airTec to EVA or airTec to PUR takes place automatically without any manual intervention.

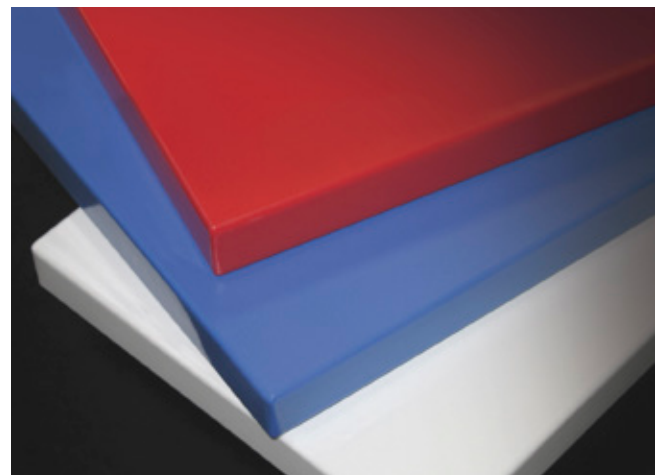

Shift operation with airTec

The airTec unit is also suited for permanent operation.



laserTec and EDGETEQ S-500 profiLine | Zero joint technology for high feed speeds

HOMAG laserTec – that's how the zero joint technology is called which fundamentally changed furniture production. With this method, a special adhesive coating on the edging strip is melted by a laser beam and then pressed directly

onto the workpiece. The result: edges complying to the highest conceivable standard of quality. Under patent law in Germany only usable with Rehau edge.

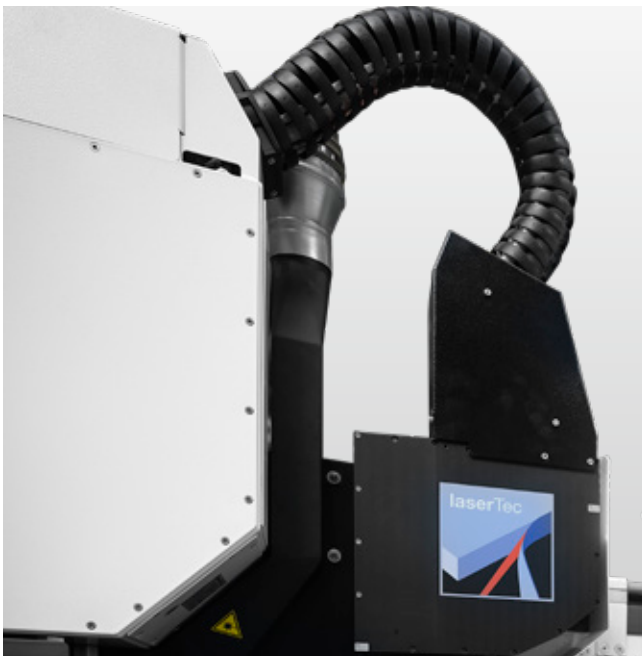

For the entire laser edge spectrum

HOMAG laserTec can be used on EDGETEQ S-500 profiLine to process all customary types of edging such as PVC, ABS, PP or PMMA. The laser-active layer can be individually adjusted in line with product and customer requirements.

OPTIMUM ECONOMY DUE TO

- Simple operating processes
- Low additional costs
- Maximum availability
- Reproducible production parameters
- Resource-saving production
- Extreme production reliability
- Used in case of high feed speeds and large workpieces

Systematic gluing

To achieve a perfect gluing it is decisive that entirely different factors interact in an optimum way. The workpiece pre-heating, the application unit, quick clamping system, melting unit, magazine and pressure zone from HOMAG are all

designed for optimum coordination. The automatic glue adjustment leads to even higher performance and cost efficiency.



Automatic glue change:

You can switch between two types of glue or color by an additional application unit



Automatic glue adjustment

The amounts of glue application are easily and rapidly adjusted via the powerTouch2 user interface.



Workpiece pre-heating

High-strength gluing due to an optimum workpiece pre-heating.



Insertion of wide solid strips

Extra wide magazine with high capacity for solid strips and optimum access to reload.

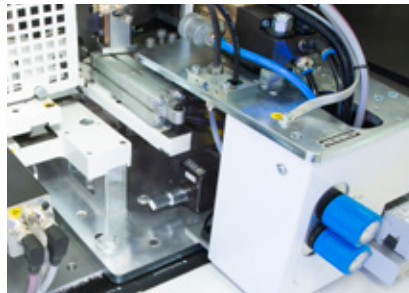

Magazine height adjustment

For processing coil material from 0.3 – 3 mm and solid strips of up to 12 mm (20 mm). Different edge thicknesses can be processed with a single edge height.



Manual one-coil magazine

1 edge feeding and 1 horizontal coil magazine. Servo-driven edge feeding to reduce edge material waste.

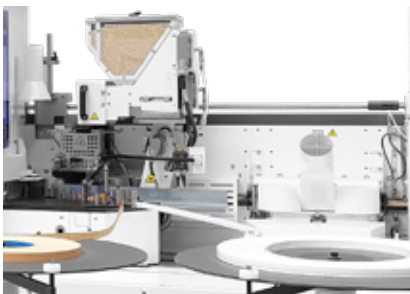

Automatic two-coil magazine

2 edge feedings and 2 coil magazines for automatic changeover between 2 edges.



Six-coil magazine

Automatic infeed of 6 different edges.

Snipping units | For cutting the face side overhang

The snipping units prepare the workpieces perfectly for subsequent trimming operation. The face side can be

snipped either straight or with chamfer.

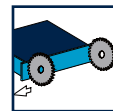
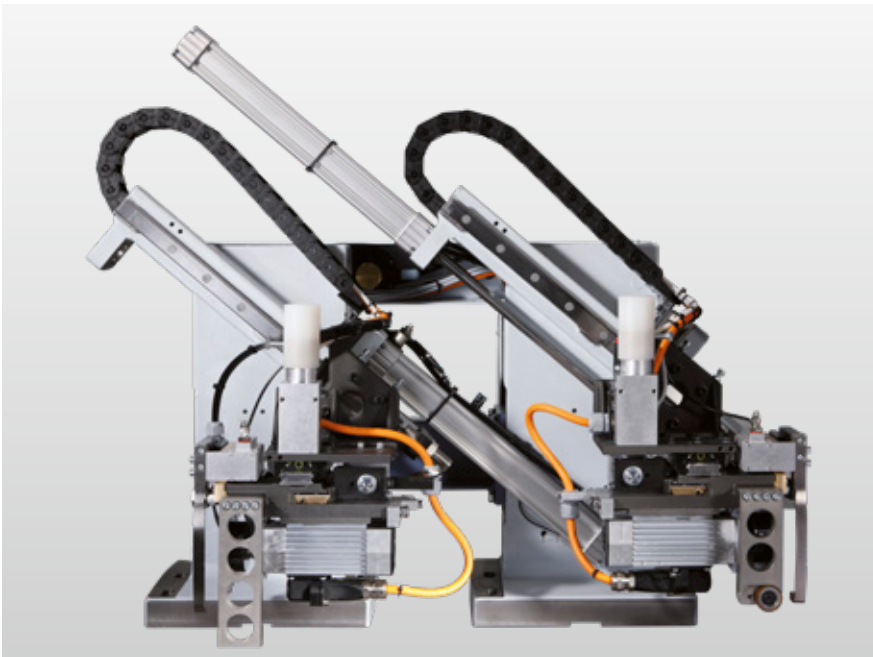

Snipping unit HL81

For a clean snipping cut of overhanging edges on leading and trailing workpiece edges using the drawing cut technique.

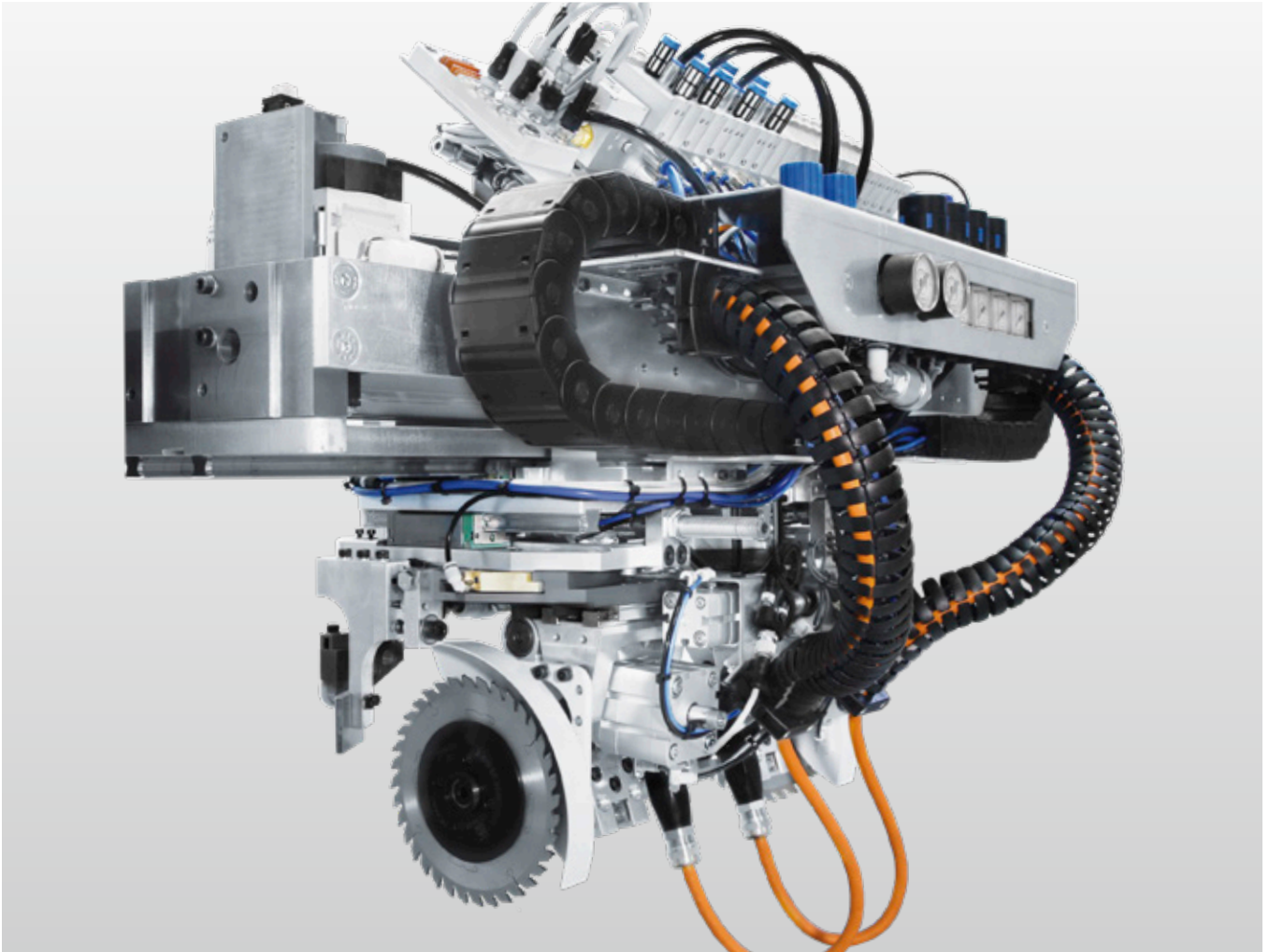

Snipping unit PK25

For snipping the edge overhang at the leading and trailing workpiece edge with stationary snipping stop.



Snipping unit PK25

Feed speed up to max. 25 m/min.

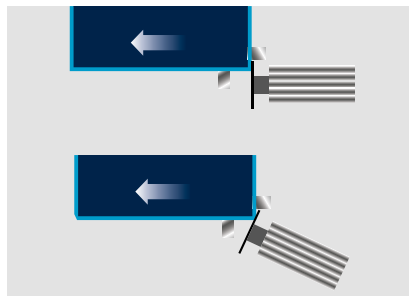

Automation as standard

Programmable chamfer/straight snipping motor adjustment for fast changeover between straight snipping and snipping with chamfer.

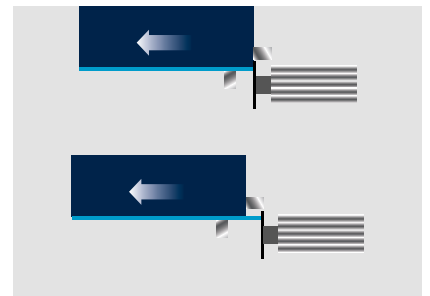

Automation to suit every need

For fast changeover between flush snipping (e.g. of solid strips or inlay shelves) and snipping with overhang (e.g. for finish trimming with profile trimming unit).

Trimming units | For flush trimming

With the rough trimming unit and the fine trimming unit HOMAG offers the right solution for the processing of projecting edges. The trimming units are equipped

exclusively with tools which capture the chips controlled. This and the HOMAG-patented HSK interface ensure a high standard of processing quality and a long tool life.



Rough trimming unit

For rough trimming the upper and lower edge overhang.

Automation to suit every need

Automatic changeover from flush trimming to trimming with projecting edge using 2-point adjustment.



Fine trimming unit PF20

For trimming chamfers and radii with optimized chip extraction and manual adjustment.

Automation to suit every need

For the automatic change of 2 radii and chamfer the unit PF21 is used.



Multi-trimming unit MF21

Automatic change of 3 radii and chamfer.

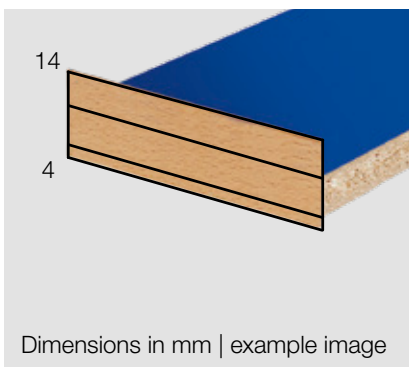

Dimensions in mm | example image

Pre-trimming unit BF10 / BF20

Larger overhang is possible by breaking out the pre-punched perforation on the dedusting hood.

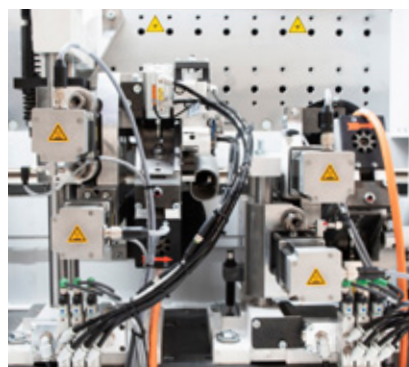

Trimming unit BF40 / MS40

Fully automatic adjustment of 1 or 2 different profiles and flush trim by means of servo motors.



- 1 Without profile: MS40
- 2 Profile 1: MS40
- 3 Profile 2: MS40

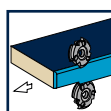
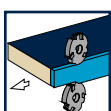



Profile trimming units | For corner rounding

HOMAG profile trimming units round the top and bottom side of the workpiece. Essential adjustments are done via program selection in the control system.

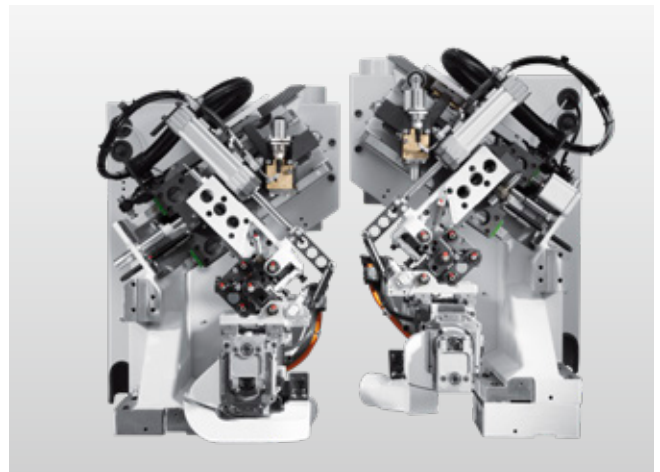

Profile trimming unit FK11

Possibility of profile change due to quick manual change of the trimming heads.

Automation to suit every need

Stepless chamfer/radius adjustment for rapid changes between processing operations, e.g. from 0.4 mm to 2 mm edge.

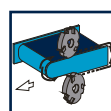

More profile trimming units

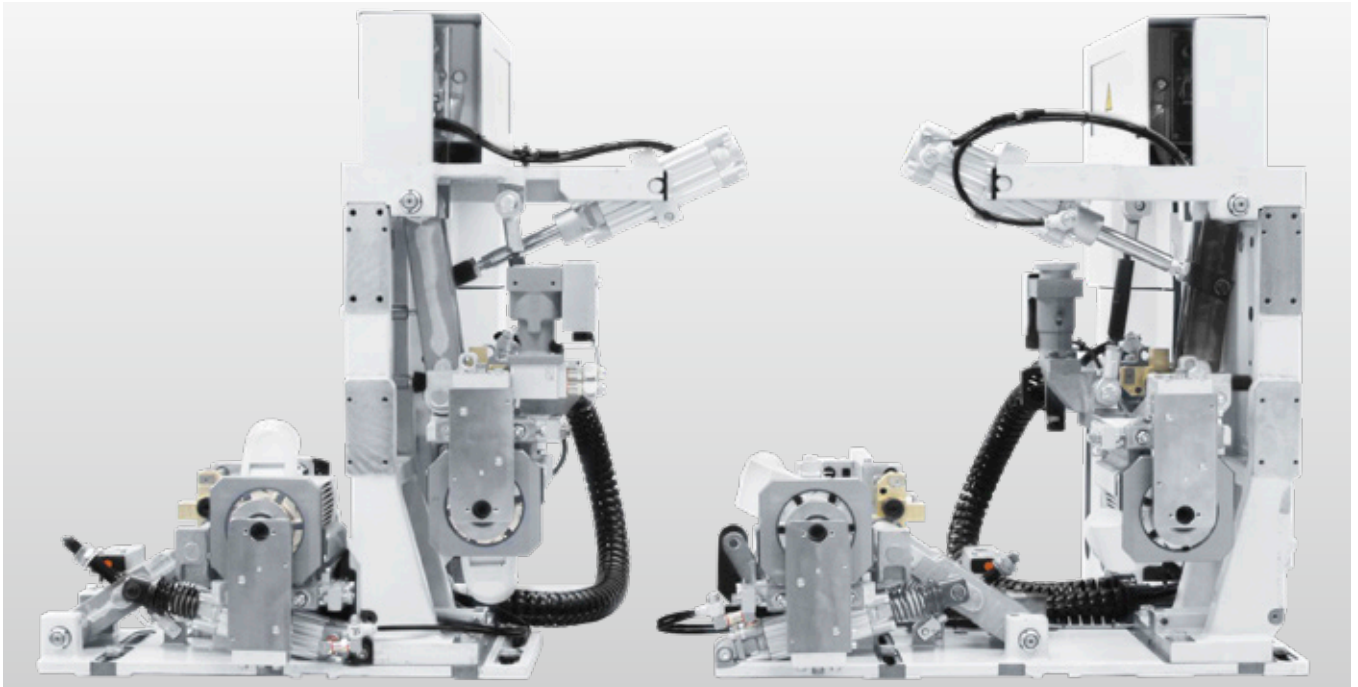

Profile trimming unit FF32

By dividing the cut over four motors, each corner can be processed in synchronous rotation. This gives corners a perfect trimmed finish with every edging type – even with veneer. Workpiece thicknesses and feed speeds are automatically adjusted without manual intervention.

Automation to suit every need

Stepless chamfer/radius adjustment for rapid changes between processing operations, e.g. from 0.4 mm to 2 mm edge.

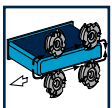

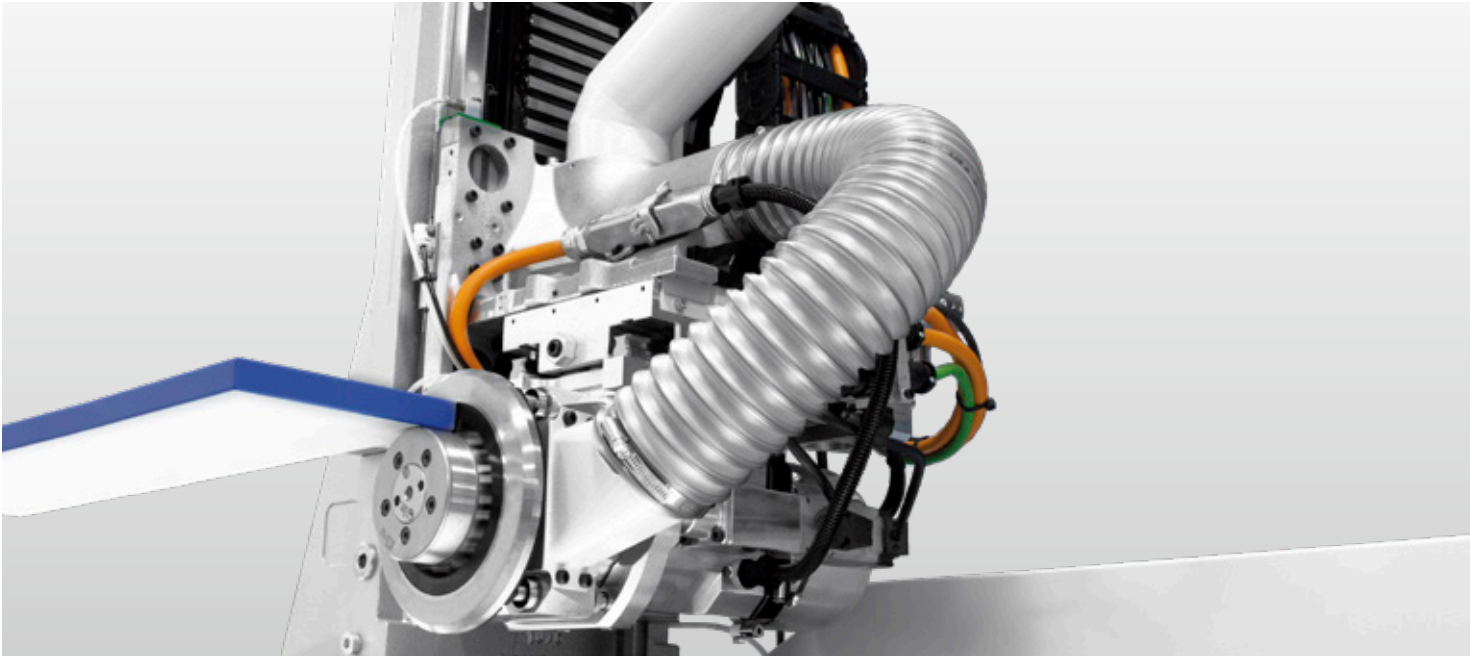

Multifunctional trimming unit MF60 Servotrim

Servo-controlled movement with soft-touch function for optimum handling of e.g. high gloss surfaces or lightweight panels.

Automation to suit every need

Adjustment between two different radii and automatic adjustment of the tracing rollers.

Profile trimming unit FK30

The movement is driven by linear motors. The high accelerations of the linear motors while edges are rounded ensure the best possible processing quality.

Automation to suit every need

Adjustment to 2 or 3 different radii and automatic adjustment of the tracing roller diameter.

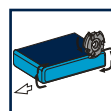
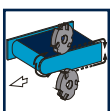

Finishing units | Optimally coordinated

The quality of your products is increased by the use of perfectly coordinated finishing units.

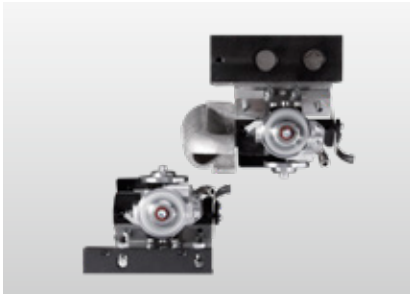

Profile scraper PN10

For smoothing trimmed edges to achieve an optimum appearance.

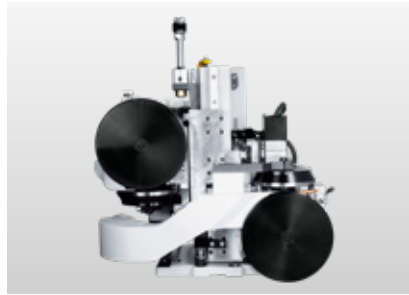

Multi scraper MN21

For smoothing trimmed edges to achieve an optimum appearance. Automatic resetting between max. 7 different profiles and corrections within the one-hundredth millimeter range. Reproducible quality to the highest standard.

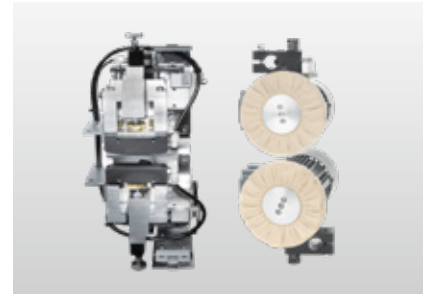

Finish processing

Comprising a glue joint scraper for disposal of glue residues at the top and bottom of plastic edges and a buffing unit.

Automation to suit every need

Travel out of the work area.

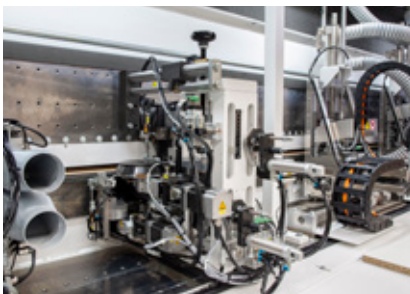

Profile scraper MN11

For smoothing the trimmed edges to achieve an optimum appearance. Automatic resetting between 2 different profiles. Fine corrections for reproducible quality at the highest level.

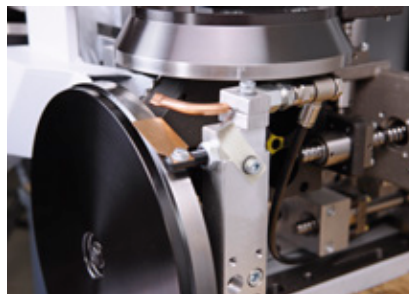

Automation

Automatic resetting to different profiles, corrections within the one-hundredth millimeter range. Reproducible quality to the highest standard.

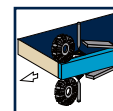
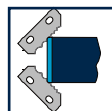
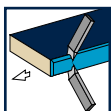

Special processes

To individually expand the functional scope of the machines, we offer you solutions for processing workpieces with protection foil/high gloss and e.g. acute- or obtuse-angled

parts or parts with hinge holes as they are produced with nesting.

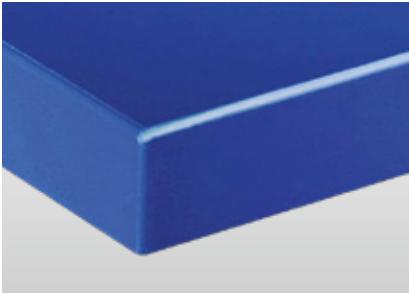

Workpieces with protection foil / high gloss

For perfect high gloss parts, important components such as motor-powered top pressure beam and automatic glue joint scraper adjustment are used.

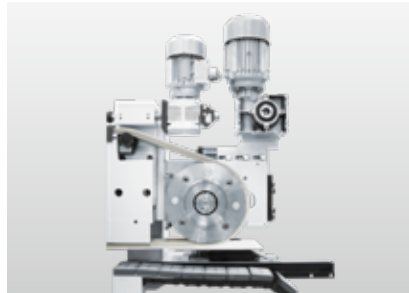

Top pressure driven by motor



Automatic adjustment of the glue joint scraper



Workpieces with hinge holes (nesting process) or acute-/obtuse-angled parts

Different tracing elements are mounted depending on the unit configuration. They are ideal for processing parts with hinge holes, as they are produced with nesting, and acute- or obtuse-angled parts.



Tracing elements for processing parts with hinge holes

Small parts processing

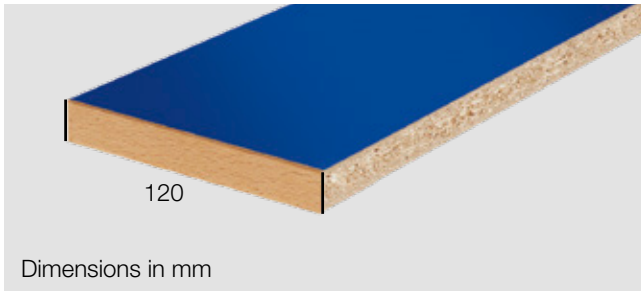

Workpiece length in throughfeed direction min. 120 mm.



Increased flexibility in the production range thanks to optimum workpiece guidance and processing workpieces also with lengths < 240 mm down to a minimum length of 120 mm. This is reached through a short roller distance at the top pressure beam.

Parts with dowels

Parts readily provided with dowels can be edge-banded subsequently, even if dowels on the transverse edge project into the processing surface.



Dowels on the transverse edge in the area of the workpiece overhang. A recessed snipping stop ensures a perfect processing result despite the presence of dowels.



Standard trimming unit for grooving | Processing in one single pass

For efficient workpiece production in a single pass without additional process steps.

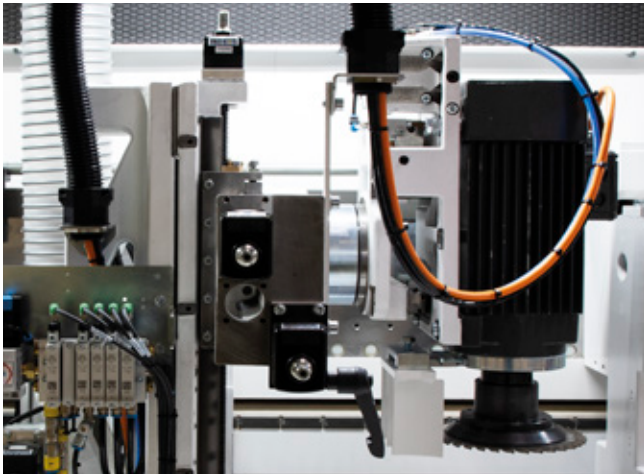

Standard trimming unit SF21

For grooving, rebate trimming and profiling inside the machine without the need for an additional processing operation.



Automation to suit every need

Adjustments are made by automatic axes or servo drives within the gap between workpieces.

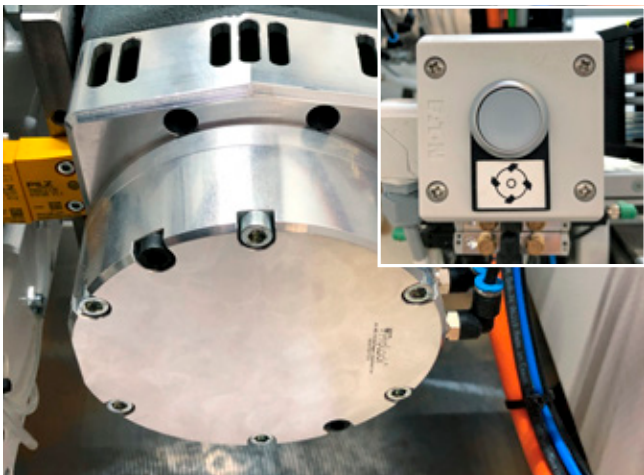

HSK push button

Fast manual tool change for different groove widths.

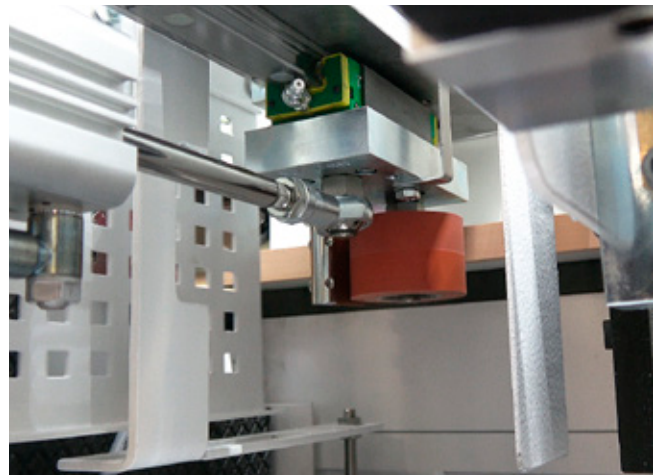

Safety device

for grooving solid strips in synchronous rotation.

Belt sanding units for EDGETEQ S-500 profiLine |

Always on top form

Whether straight edges, chamfers or radii in veneer: You can rely on our HOMAG belt sanding units – belt sanding unit KS10 or chamfer/radius sanding units PS41/PS42.



Belt sanding unit KS10

For sanding straight veneered edges including oscillation as a standard feature.

Automation to suit every need

For traversing out of the work area and stepless adjustment to different edge thicknesses.

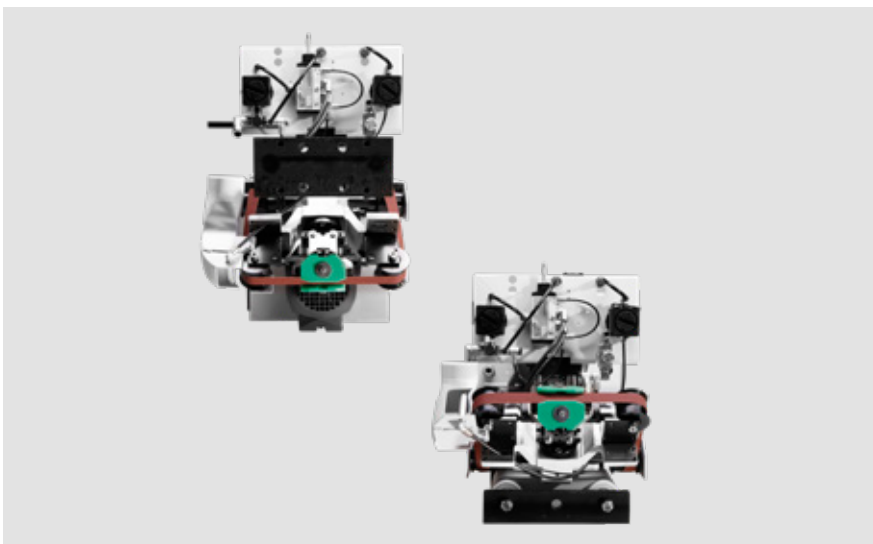
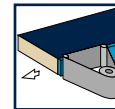

Chamfer/radius sanding units PS41 and PS42

For sanding chamfers and radii at the top and bottom of veneer edges.

Automation to suit every need

For traversing out of the work area and stepless adjustment to different edge thicknesses.

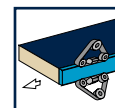

2-profile technology | Automatic and exact changeover

By means of the HOMAG 2-profile technology, you can automatically change between 2 profiles and chamfer. The axis adjustments allow a short setup time with optimum repeat accuracy.

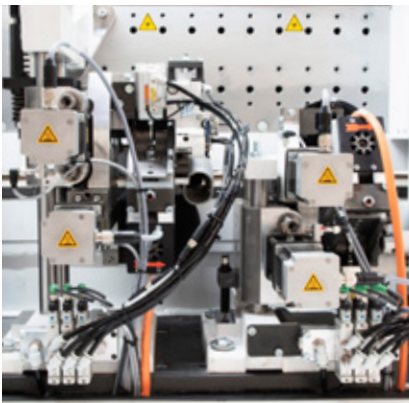

Multi-stage trimming unit MS40

Fully automatic adjustment between 2 different profiles and flush trim by means of servo motors.



Multifunctional trimming unit MF60 Servotrim

Trimming of the top and bottom edge overhang as well as corner rounding on the front and rear edge.

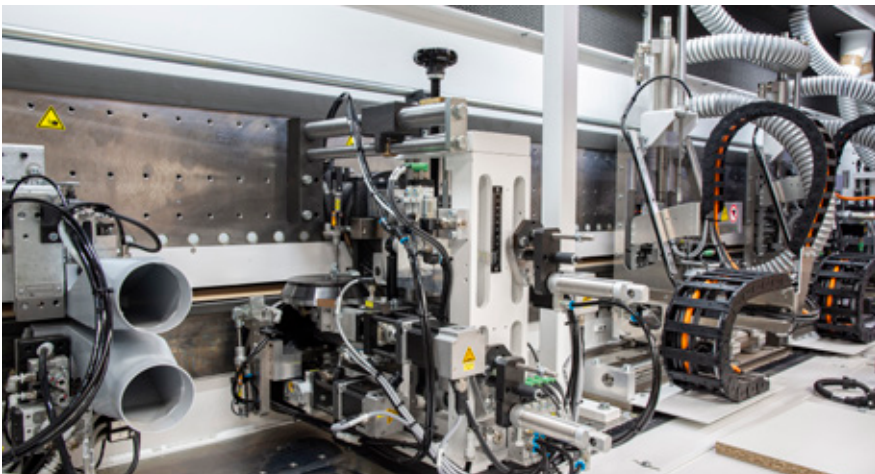

Multi scraper MN11

For smoothing trimmed edges for an optimum appearance.

3-profile technology |

Shortening setup times and achieving perfect results

By means of the HOMAG 3-profile technology, you can automatically change between 3 profiles and chamfer. Besides short setup times, you will reach a reproducible quality on the highest level.



Multi-trimming unit MF21
For profile trimming of the edge.

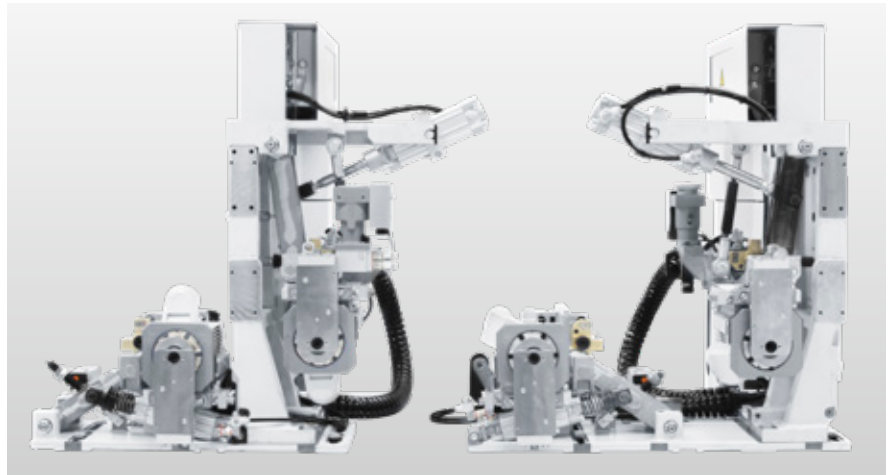

Profile trimming unit FF32
For rounding edges at the leading and trailing workpiece edge top and bottom at different feed speeds.

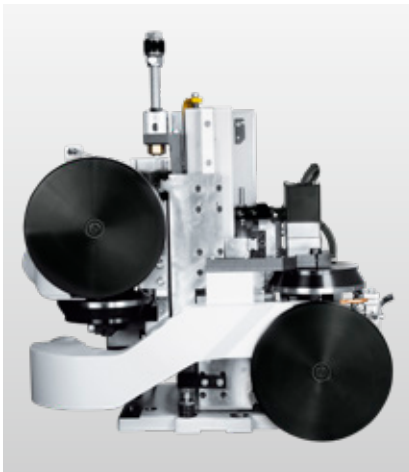

Multi scraper MN21
For smoothing trimmed edges for an optimum appearance.

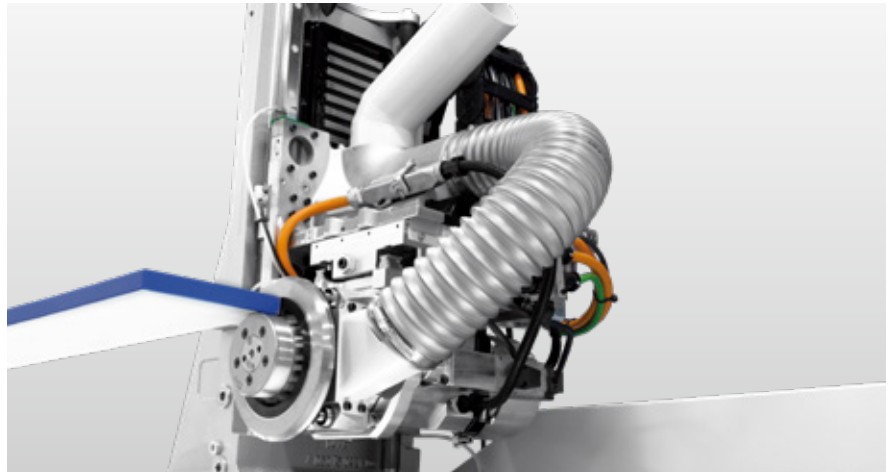

Profile trimming unit FK30
For trimming around the leading and trailing edge.

The next generation of powerTouch: **powerTouch2**

Faster, more comfortable, clearer: Enjoy the benefits of our further improved powerTouch user interface. We have optimized our standardized operating concept and further adapted it to our customers' requirements. Controlling your

HOMAG machines is now even faster and more intuitive. The new, modern design has a clear structure. The innovative touch operation is designed to enable you to get the desired result easily and comfortably.



Our successful powerTouch philosophy – **standardized, simple, ergonomic, evolutionary** – consistently further developed

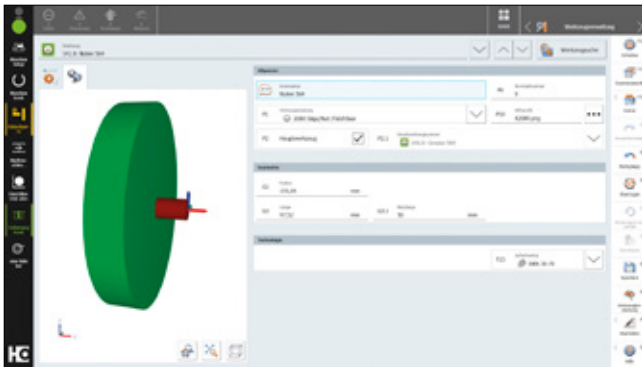

Clearer structure

The structure of the powerTouch2 screen is even clearer. You only see the information that is relevant for you. The important points at a glance – but you still have all the details. All in a fresh, attractive design.

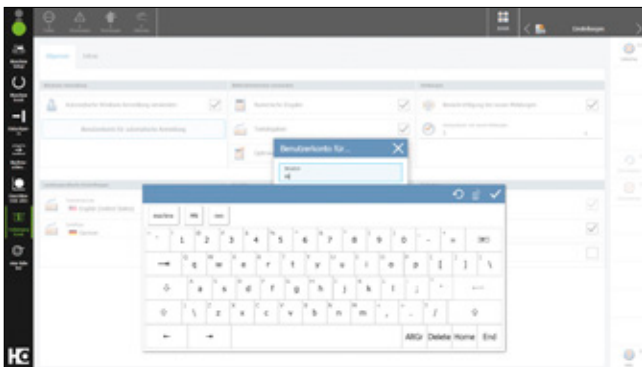

Even faster

With the new powerTouch generation, you can enter information at your machine even more quickly. Compared to the previous version, you can achieve a time saving of up to 30%. This is possible thanks to new features, such as automatic word completion, a pop-up keyboard that can be kept open and Windows-like functions, such as the selection of common actions directly via the start button.



More intuitive

Operating the machine is child's play. Many of the functions are similar to those of a smartphone or tablet and will therefore be familiar to you. Even beginners will feel immediately at ease and will soon be able to control the machine comfortably.

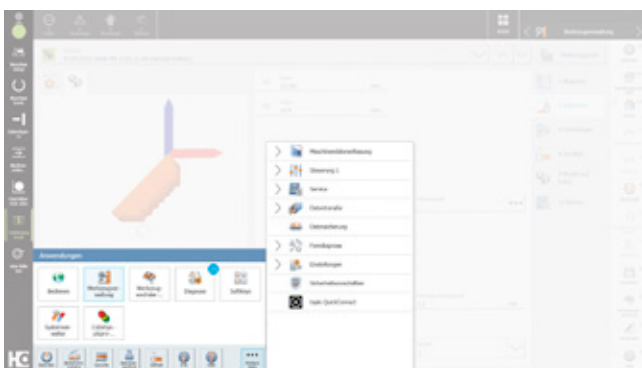

More comfortable

We have also improved the traffic light dialog and the „Start“ menu. When you press and hold the program icon, not only are the possible actions displayed, you can also access and activate them directly. Operation is therefore immediate and you do not lose any time opening applications. What's more, for the applications, illustrations and additional information can be displayed instead of simple program icons. This also provides more transparency and avoids unnecessary navigation into applications.

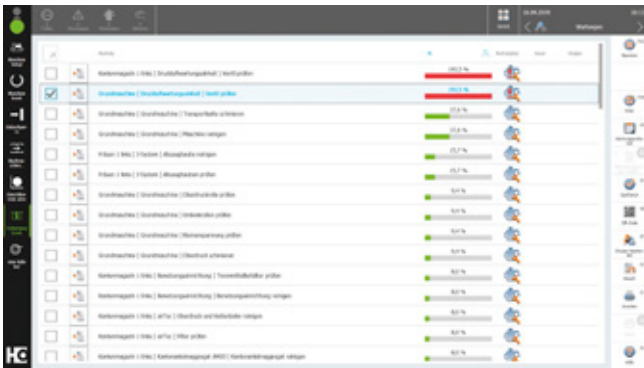

Evaluation with MMR Basic

The software evaluates the productivity of your machine and supplies usage-dependent maintenance notifications.

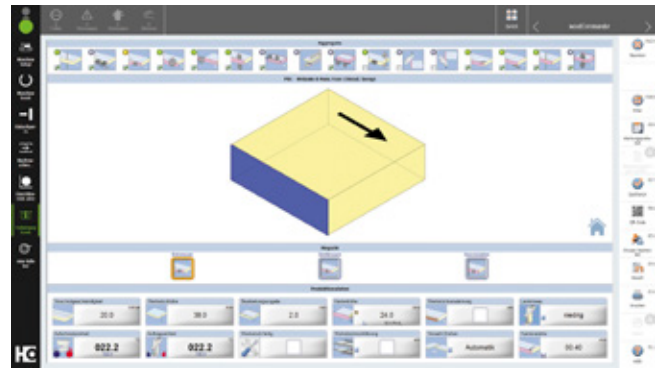

Programming with woodCommander

User-friendly programming system using graphically supported input screens.

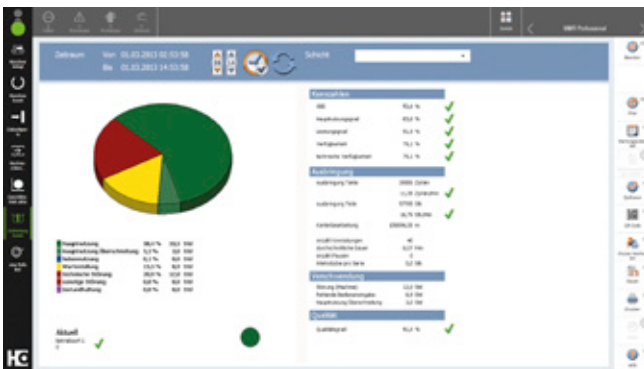

MMR Professional

The MMR Basic upgrade additionally evaluates shifts, analyzes error messages and permits a link to be created to the data evaluation center in the office.

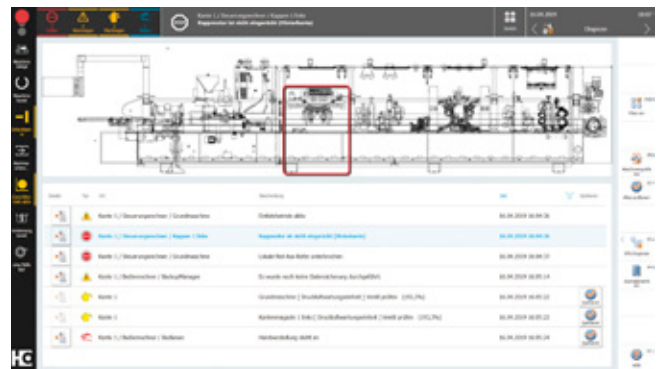

woodScout diagnostic system

Alongside error messages in plain text, woodScout also provides a graphic representation of the error location on the machine. In addition to the system's expert knowledge database, users can store their own troubleshooting solutions.



Support via serviceRemote

Fastest service and help by targeted error analysis and support by means of TeleService via Internet.

Apps that make working life easier.

tapio
Partner

DataSave

- Protects machine and configuration expertise
- Faster service for machine breakdowns
- Saves time when restarting production
- Saves on maintenance costs
- Automatic backups of several machines

ServiceBoard

- Create service cases quickly and easily and send them to the correct service partner
- Live video diagnostics to solve service cases with image support
- Video reduces the language and distance barriers
- Also works without a machine connection to tapio (and is therefore ideal for older machines)

MachineBoard

- Push notifications
- Machine data and status can be viewed from anywhere in real time
- Lists of errors, warnings, maintenance tasks and actions
- Displays the remaining time until the next intervention by the machine operator

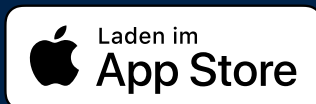

Free demo for all tapio apps, no registration required. Simply download and test.

tapio is the open wood industry ecosystem

This means that everyone involved in the wood industry can participate.
Because together with our business partners, we develop digital solutions for everyone.

Currently available in the EU and Switzerland.

(Due to the fast pace of the IT-landscape, the compatibility to the tapio platform is warranted for five years).





Increased productivity for edge banding machines

Workpiece return conveyors of the LOOPTEQ series provide the ideal complement to the machines of the EDGETEQ series. The LOOPTEQ O-200 is best suited for small, narrow, and medium-sized workpieces. The LOOPTEQ O-300 is ideal for high material variety, from small and light up to large and heavy workpieces. Its high degree of automation makes the return conveyor LOOPTEQ O-600 with workpiece handling a real multi-talent.

LOOPTEQ O-200

THE ENTRY TO A COMFORTABLE MATERIAL FLOW

The LOOPTEQ O-200 is the perfect supplement for unilateral edge banding machines as essential support for an economic workpiece return. The production process will be more efficient, whether batch size 1, batch, or serial production.

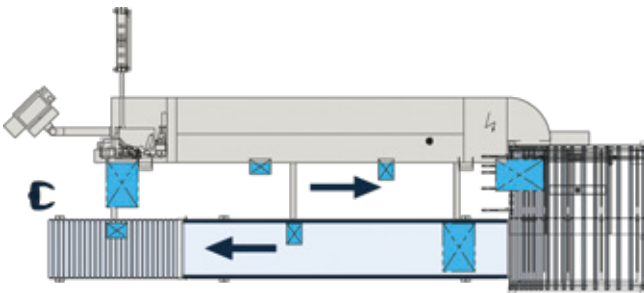
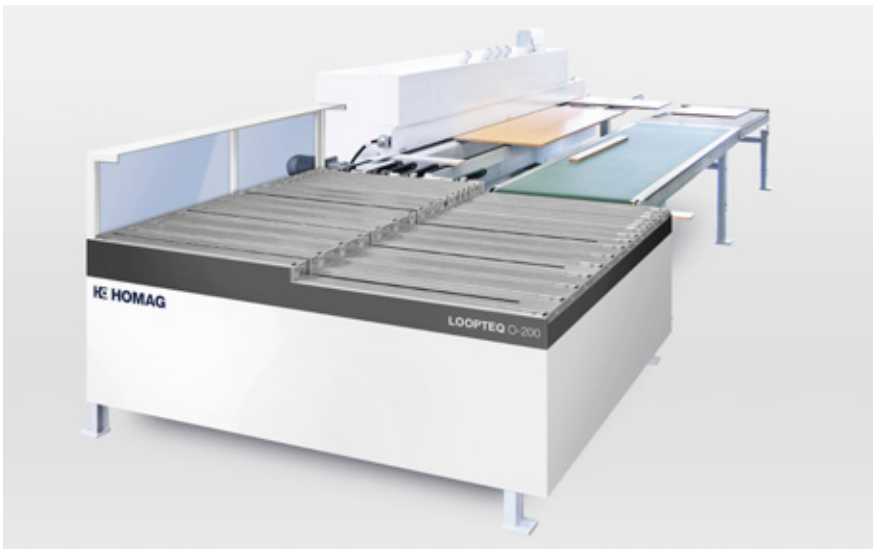

Technical data

Workpiece data

Workpiece length	300 – 2,500 mm
-------------------------	----------------

Workpiece width	50 – 1,450 mm
------------------------	---------------

Workpiece size

4-sided processing*

min. workpiece length	300 × 300 mm
-----------------------	--------------

max. workpiece length	1,450 × 1,450 mm
-----------------------	------------------

Workpiece thickness	8 – 60 mm
----------------------------	-----------

Workpiece weight

Workpiece length ≤ 700 mm	max. 30 kg
---------------------------	------------

Workpiece length > 700 mm	max. 50 kg
---------------------------	------------

Mass per unit area	max. 25 kg/m ²
---------------------------	---------------------------

Working height	835 – 950 mm
-----------------------	--------------

Feed speed	8 – 25 m/min
-------------------	--------------

*Larger workpieces can be returned or even fed out at 4-sided processing with manual support during crosswise offset and turning.

IDEALLY SUITED FOR SMALL, NARROW, AND MEDIUM-SIZED WORKPIECES

- Fast amortization – pays off from 9 hours working time per week
- Flexible operator organization – thanks to economical one-man operation
- Ergonomic working – manual parts handling is reduced to a minimum
- Improved quality control – rapid response to material adjustments



Turning bolt for narrow parts,
sensor controlled (option)



Small roller gib to support wide
workpieces (option)



Belt cleaning equipment (option)

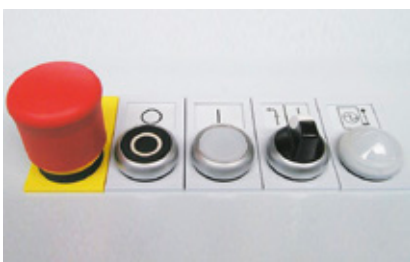

Operating terminal



Equipment to achieve CE-conformity:
rip cord back to the return belt

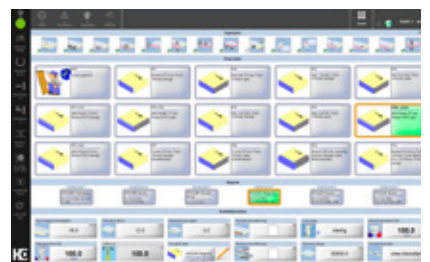

Integration of controls: Control of
the LOOPTEQ is integrated into the user
interface of the edgbanding machine.

LOOPTEQ O-300

FOR A WIDE SPECTRUM IN THE MATERIAL FLOW

Whether handicraft or industrially oriented production. The LOOPTEQ O-300 transports the largest material variety and is indispensable for an economic workpiece return. It convinces by its high capacity and an especially gentle workpiece handling.

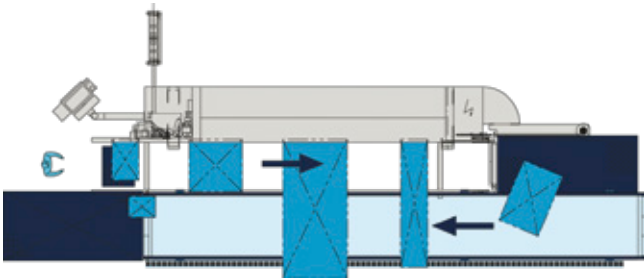

Technical data

Workpiece data

Workpiece length	300 – 2,500 mm	240 – 2,700 mm
Workpiece width	60 – 800 mm	60 – 1,000 mm
Workpiece size	4-sided processing*	
min. workpiece length	300 × 80 mm	240 × 80 mm
max. workpiece length	2,000 × 800 mm	2,500 × 1,000 mm
Workpiece thickness	8 – 60 mm	8 – 80 mm
Workpiece weight	max. 50 kg	max. 50 kg
Mass per unit area	max. 25 kg/m ²	max. 25 kg/m ²
Working height	835 – 950 mm	835 – 950 mm
Feed speed	8 – 30 m/min	8 – 30 m/min

*Larger workpieces can be returned or even fed out at 4-sided processing with manual support during crosswise offset and turning.

BEST SUITED FOR HIGH MATERIAL VARIETY, FROM SMALL AND LIGHT UP TO LARGE AND HEAVY WORKPIECES

- Fast amortization – pays off from 15 hours working time per week
- Low quality costs – gentle workpiece handling with air cushion table
- Flexible operator organization – thanks to economical one-man operation
- Ergonomic operation

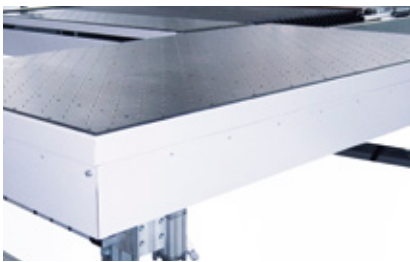

Liftable air cushion table for outfeed
(option)



Small roller gib, lowerable
(option)

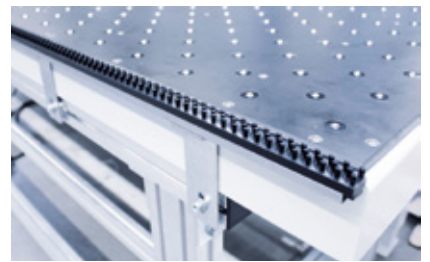

Brake brushes for air cushion table
(option)



Belt cleaning equipment (option)



Equipment to achieve CE-conformity:
rip cord back to the return belt

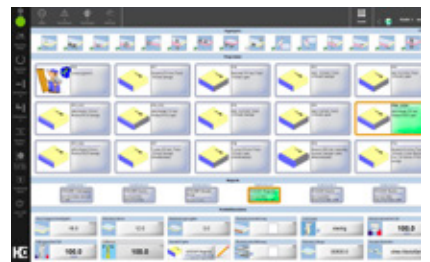

Integration of controls: Control of the LOOPTEQ is integrated into the user interface of the edgbanding machine.

LOOPTEQ O-600

MORE FLEXIBILITY FOR THE MATERIAL FLOW

Stacking unit and return conveyor combined in one machine. The high automation degree makes the return conveyor LOOPTEQ O-600 a real multi-talent. Finished workpieces can be fed out or stacked.

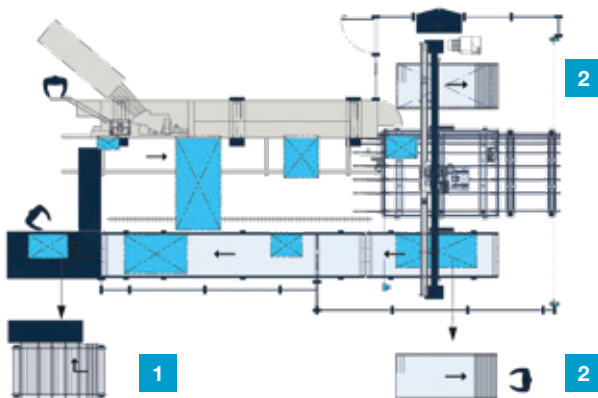

1 Function Ergonomics Package II - Angular transfer combined with air cushion table for an ergonomic workpiece handling

2 Function Removal - Stacking position

Technical data

Workpiece data

Workpiece length	240 - 2.500 mm	240 - 3.000 mm
Workpiece width	80 - 1.200 mm	80 - 1.200 mm
Workpiece size	4-sided processing*	
min. workpiece length	240 × 120 mm	240 × 120 mm
max. workpiece length	2.500 × 1.200 mm	3.000 × 1.200 mm
Workpiece thickness	8 - 60 mm	8 - 60 mm
Workpiece weight	max. 80 kg	max. 80 kg
Mass per unit area	max. 25 kg/m ²	max. 25 kg/m ²
Working height	835 - 950 mm	835 - 950 mm
Feed speed	12 - 36 m/min	12 - 36 m/min
Stacking position	0, 1, 2	0, 1, 2

* Larger workpieces can be returned or even fed out at 4-sided processing with manual support during crosswise offset and turning.

BEST SUITED FOR CUSTOMERS WITH HIGH MATERIAL VARIETY AND A PRODUCTION WITH HIGH AUTOMATION DEGREE.

- Low quality costs – gentle handling via vacuum traverse
- Flexible operator organization – thanks to economic one-man operation
- Ergonomic operation – operator will be released from heavy physical work
- Intelligent automation – interlinked material flow with high capacity
- Efficiency increase – defined rotation for process optimized panel return



Crosswise transfer device
(option)



Collecting of workpieces
(option)



Belt cleaning equipment
(option)



Brake brushes for air cushion table
(option)



Equipment to achieve CE-conformity:
protection grid along the complete return section

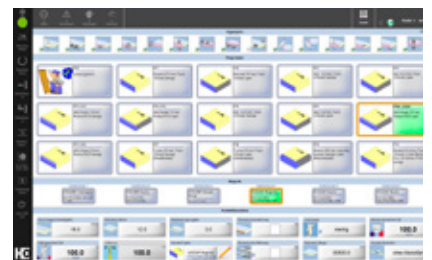

Integration of controls: Control of the LOOPTEQ is integrated into the user interface of the edgbanding machine.

Production lines with EDGETEQ S-500 profiLine

The machines of the EDGETEQ S-500 profiLine series are designed in such a way that two of them can be linked to form a production line. They can be combined e.g. with an

infeed system or an offset station. Ask for HOMAG basic concepts 1 and 2.

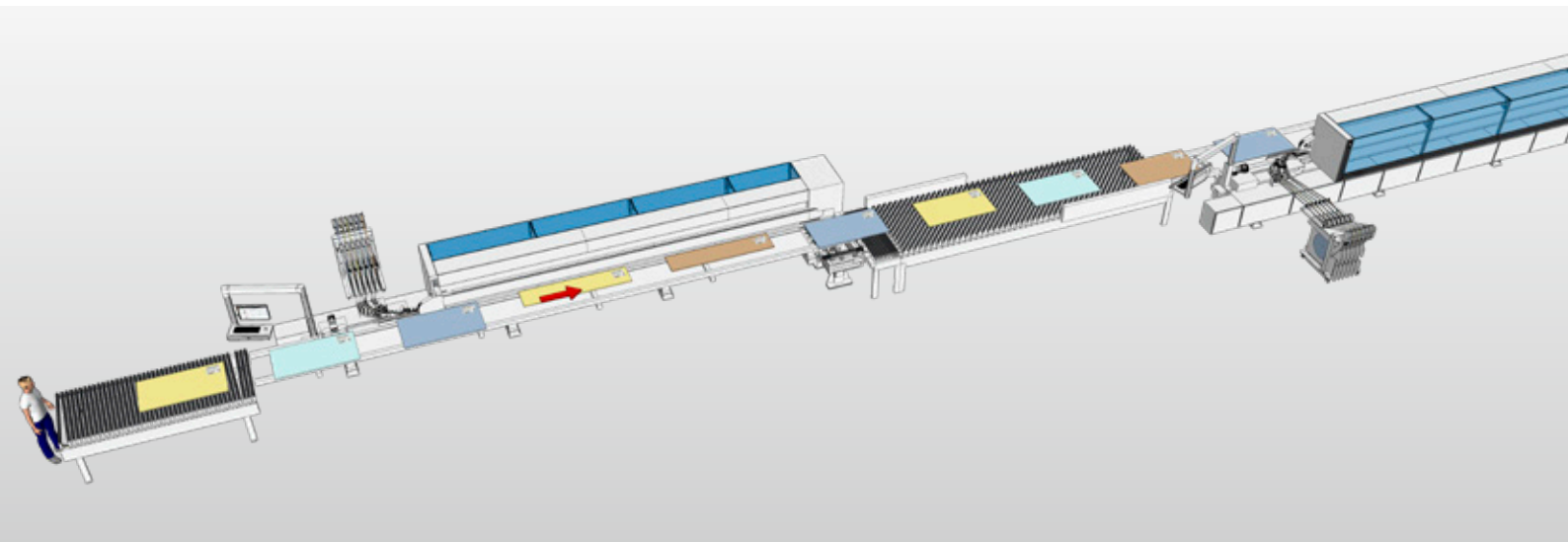

Production line for medium capacities

In this example the 4 sides of workpieces are processed in two work steps. The workpieces are returned in stacks or individually.

woodFlex cell control

For the control of the production line and for workpiece tracking.





HC LIFE CYCLE SERVICES

Optimal service and individual consultations are included in the purchase of our machines. We support you with service innovations and products which are especially tailored to your requirements. With short response times and fast

customer solutions we guarantee consistently high availability and economic production – over the entire life cycle of your machine.



REMOTE SERVICE

- Hotline support via remote diagnosis by our trained experts regarding control, mechanics and process technology. Thus, more than 92% less on-site service required and consequently a faster solution for you!
- The ServiceBoard App helps to solve tasks in a fast, simple and concrete way. This is achieved by mobile live video diagnosis, automatic sending of service requests or the online spare parts catalog eParts.



SPARE PARTS SERVICE

- High spare parts availability and fast delivery.
- Ensuring quality by predefined spare parts and wear parts kits, comprising original spare parts.
- Identify and inquire for spare parts online under www.eParts.de 24/7, or buy even faster and more comfortably in the new HOMAG eShop (shop.homag.com).



MODERNIZATION

- Keep your machinery up to date and increase your productivity as well as your product quality, This is how you can meet tomorrow's requirements today!
- We support you with upgrades, modernization as well as individual consultancy and developments.



DIGITAL SERVICES

- serviceRemote – the new remote service solution of the future! Fast restart of production because the remote service employee has extensive access to relevant physical data.
- serviceAssist – provides help for self-help. The preventive solutions proposed in the new App are the combination of our experiences and existing machine data.



SOFTWARE

- Telephone support and consultancy through software support.
- Digitalization of your spare parts via 3D scanning saves time and money compared to new programming.
- Subsequent networking of your machinery with intelligent software solutions ranging from construction to production.



FIELD SERVICE

- Increased machine availability and product quality by certified service staff.
- Regular checks through maintenance/inspection guarantee the highest quality of your products.
- We offer you the highest availability of technicians in order to reduce downtimes in case of unpredictable troubles.



TRAINING

- Thanks to training perfectly suited to your requirements, your machine operators can optimally operate and maintain the HOMAG machines.
- The training also includes customer-specific training documents with exercises proven in practice.
- Online training and webinars. Learn without traveling, meet your trainer in the digital classroom.

For you more than...

1,350

service employees worldwide

92%

less on-site service thanks to successful remote diagnosis

5,000

customers in trainings / year

150,000

machines, all electronically documented in 28 different languages – in eParts

HOMAG Group AG

info@homag.com

www.homag.com



YOUR SOLUTION