

Extremely durable. Top-class sanding.

HE HOMAG

Our Wide-Belt Sanding Machines

SANDTEQ W-900

SANDTEQ B-700

YOUR SOLUTION





NEW

The IntelliSanding App is your perfect companion for everything concerning sanding. Download the app from your store today!





For customers with the highest quality standards – the SANDTEQ W-900.

For more than 70 years, HOMAG sanding technology has been renowned for its powerful wide-belt sanding machines and innovative surface processing. This includes special and universal sanding machines for calibration, fine sanding and lacquer sanding. Always focused on processing wood and wood-like materials.

HOMAG is present and active throughout the world. Whether consulting, selling or providing fast on-site service, HOMAG is ably supported and represented in over 65 countries.

YOUR SOLUTION

MORE: [HOMAG.COM](https://www.homag.com)



SANDTEQ W-900

CONTENTS

- 04 Introduction
- 06 SANDTEQ W-900
- 08 Sanding heads technology
- 24 Special heads
- 26 The control concept
- 28 Pressure beam systems
- 32 All inclusive
- 36 Options
- 26 Technical Data
- 30 Life Cycle Services



Top-class sanding technology...

Professional high-tech sanding technology – that's the SANDTEQ W-900. Due to its modern and efficient equipment the series sets new standards in technology, ergonomics and availability. And everything »Made in Germany«. This top-class model range offers customers with highest demands high availability without any compromises regarding quality

during operation. The machines can be individually equipped. The well-established and wide range of head combinations and further intelligent options can respond to special requirements.

“From the most demanding interior design through to the furniture and flooring industries – the power house of the HOMAG SANDTEQ”

Josef Zerle, Executive Director Surface Processing, HOMAG



Sanding line

- The Wide-Belt Sanding Machines SANDTEQ W-900 and SANDTEQ B-700 can be combined with each other and thus easily offer sanding from top and bottom in one process. For a continuous transport of the workpiece they can be directly connected.



powerTouch operating panel

- Now professional sanding technology can be controlled even easier. With the latest generation of powerTouch operating philosophy with graphical operator guidance, it is easier and faster for you to reach the required functions.



SORB TECH – patented technology for unique quiet running

- The patented composite material SORB TECH is characterized by an outstanding and fast vibration absorption, which is even superior to welded frame and cast iron constructions.

Up to **5** heads in a single machine frame

Processing width

1,350 mm

1650 mm as an option

Very stable – total weight up to

15,000

kg for an SANDTEQ W-900 (955)



The SANDTEQ W-900

The SANDTEQ W-900 is also suitable for extremely difficult calibrations. The basic machine consists of the fibre-reinforced cast mineral SORB TECH, making the SANDTEQ W-900 extremely resistant. The feed is directly screwed

with the cast mineral leading to specially quiet running and precision even at highest feed speeds with frequent control processes. The main drive unit with Poly-V-belt ensures an optimal power transmission. Best conditions for best quality.

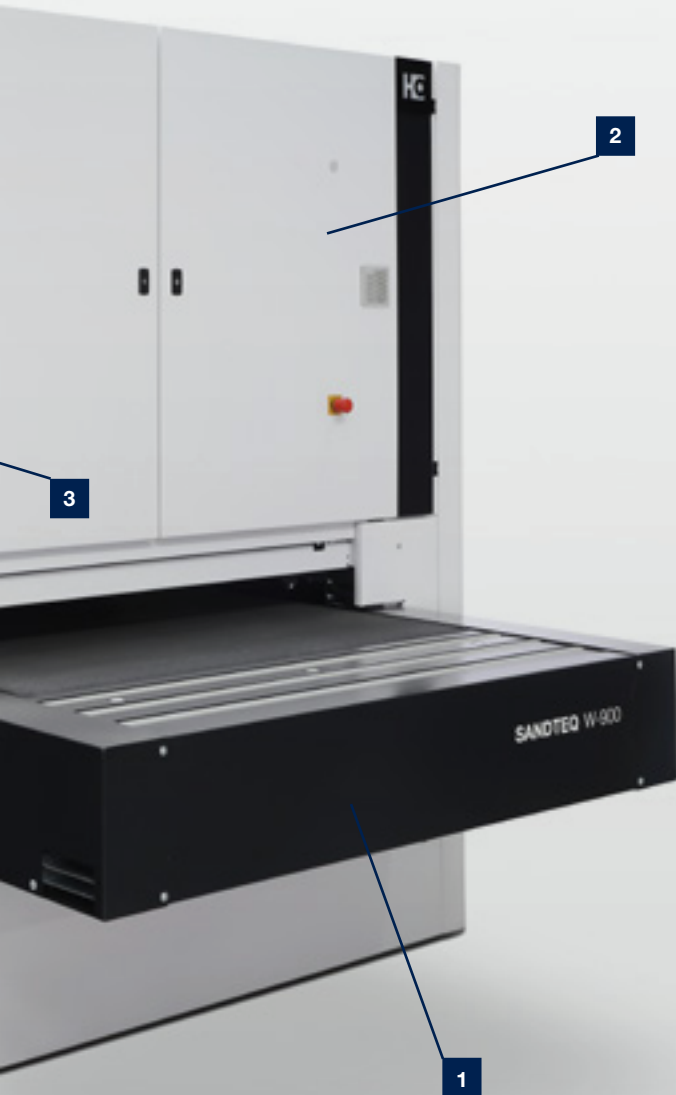

- 1** Secure, careful workpiece transport for years. Highquality feed belts in various designs and specially rubberized rollers ensure this.
- 2** Large switch cabinet at the front and rear of the machine.
- 3** powerTouch with the user-friendly “Sanding Center” interface to make light work of controlling the technological possibilities available.
- 4** Doors on the belt changing side with window insert. This gives an insight into the process and ensures improved dust extraction thanks to air inlets. The E-Lock protects employees.
- 5** In the machine base are for example the drive motors, vacuum ventilator and the height adjustment. This means that no additional space is required.

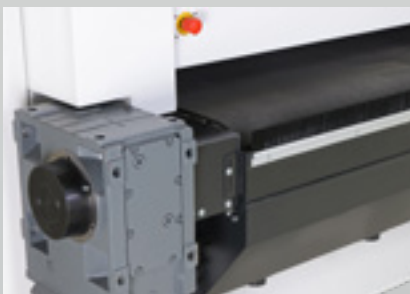

Feed speed

- Infinitely variable control of the feed speed

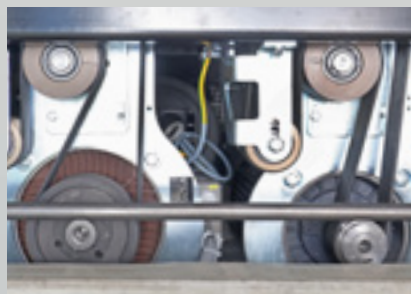

Motors between 15 kW and 45 kW

- Drive power, together with material hardness, sanding materials and feed speed determine maximum chip removal.



Workpiece geometry

- No matter what material in what shape. You can play it safe with the mps segmented magnetic pressure beam system.

Contact roller head R |

exact tolerance calibration at high stock removal rates

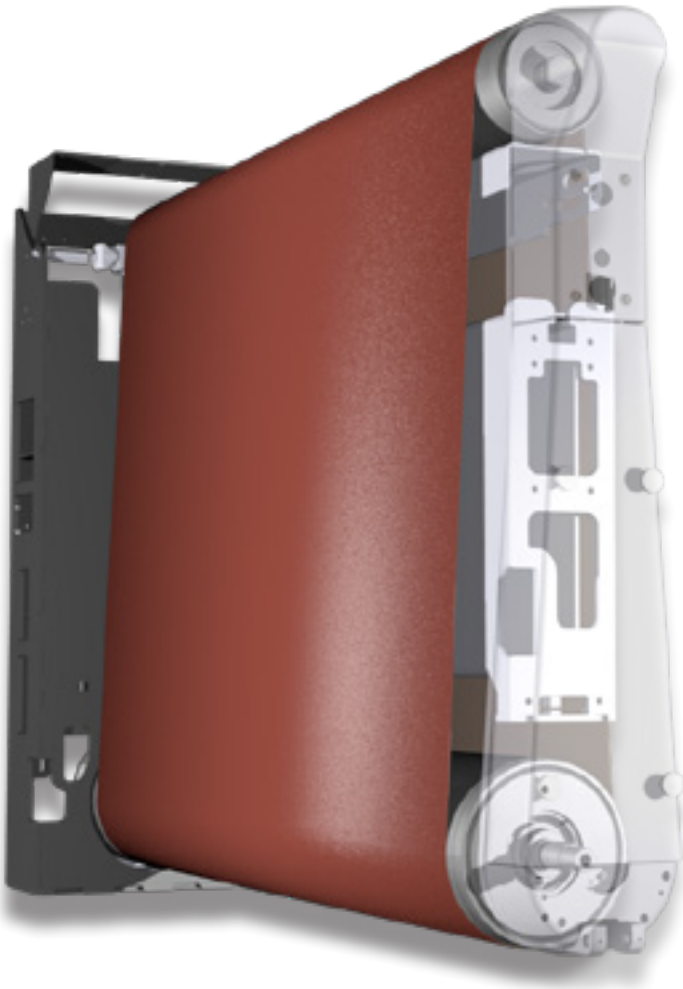

Do you machine large quantities of solid wood and want to calibrate to full width with high removal rates? Then you are in the right place.

- **Calibration with precise tolerance at high removal rates**
- **Steel or rubber profiled contact rollers measuring up to 240 mm or 320 mm in diameter**
- **No washout effect of early/late wood portions**

Applications:

- **Calibrated sanding of wood and wood materials**
- **Defined roughening of surfaces in preparation for adhesion**

Range of useful grains:

- **Calibrated sanding: P40 – 120.**

“The calibration process with high removal rates ensures the R-Head with up to 45 kW drive power.”

Torben Hellmann, Area Product Manager Surface Processing, HOMAG

Combi head C | perfect for simple calibrations

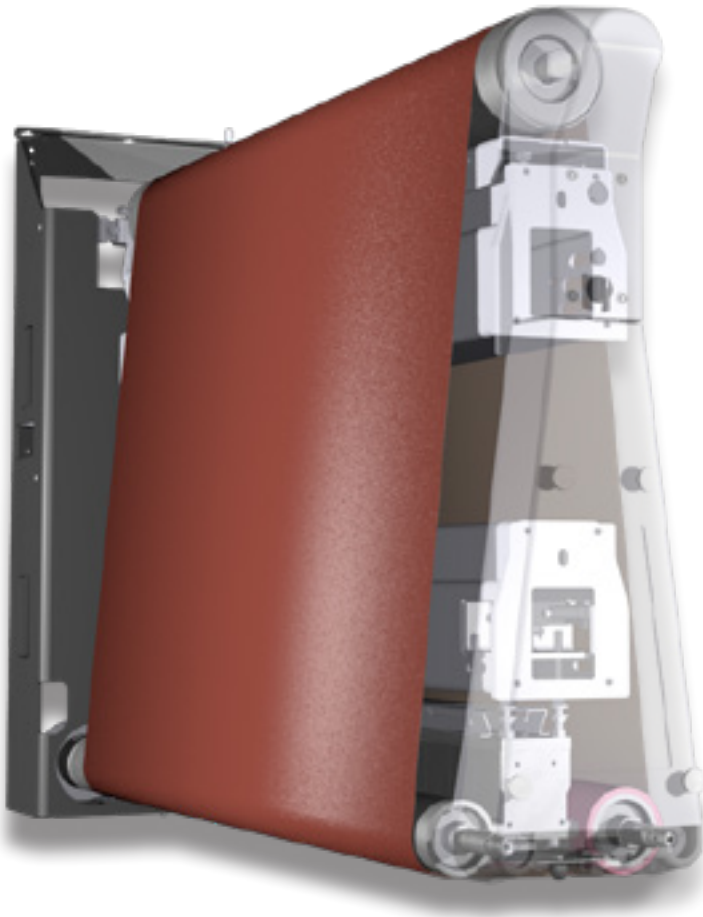

You require calibration and fine sanding? And that in a very small space? Then you are in the right place.

- Unit for easy calibration work with adjustable deflection roller for fine sanding
- Exact tolerance calibration without “wash out” effect
- Thickness tolerance variations of up to 2 mm in veneered and lacquered parts are easily handled by the use of the segmented pad

Applications:

- Veneer sanding
- Fine sanding and calibrating of wood and wood materials
- Lacquer sanding

Range of useful grains:

- Calibration P60 – 120
- Fine sanding P120 – 320
- Lacquer sanding P240 – 320

acp[®] mps^{2.0+}

“If versatility is more important than high volumes, then the universal C-Head is your best choice!...”

Matthias Picker, Product Management Surface Processing, HOMAG

Electronic pressure beam E | adjustment to different materials

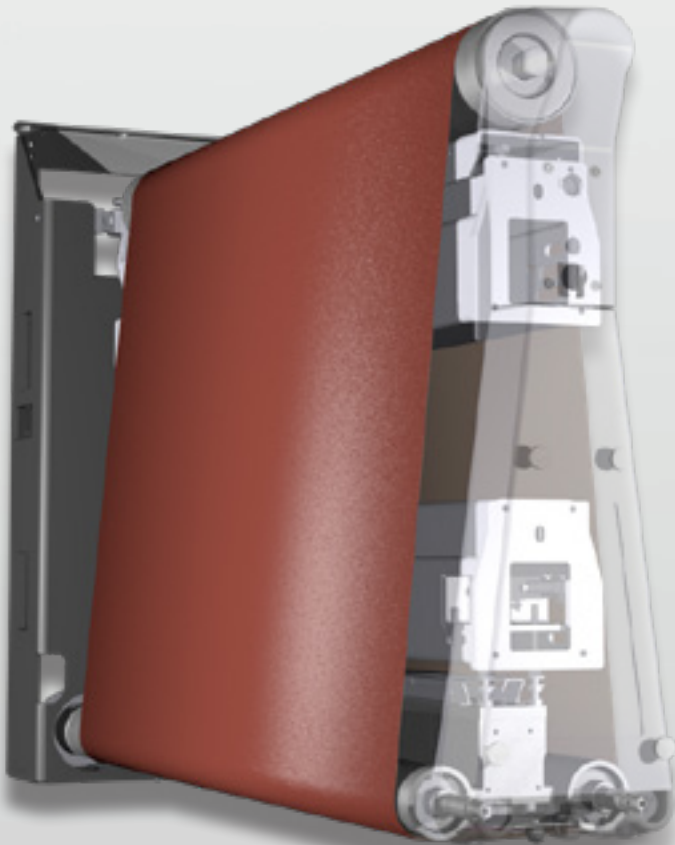

Fine sanding with the highest level of user safety

- Thickness tolerance variations of up to 2 mm in veneered and lacquered parts are easily handled by the use of the segmented pad
- No “sanding through” of edges due to fine geometric resolution
- Can adapt to most applications thanks to variable cutting speed

Applications:

- Fine sanding of wood and wood-based materials, as well as painted surfaces
- Improving and upgrading pre-sanded surfaces

Range of useful grains:

- Fine sanding P120 – 320
- Lacquer sanding P240 – 320

acp[®] mps^{2.0+}

“The unit for intensive yet still adaptable sanding.”

Paul Matthies, Application Engineering Surface Processing, HOMAG

Chevronbelt H |

for specially homogeneous surfaces



High-quality surfaces are important for you? Then you are in the right place. This head is suitable for veneer, paint and filler sanding.

- Dimensional tolerances are compensated by up to 2 mm using the pressure beam
- Can adapt to most applications thanks to variable cutting speed
- No scuffing of the edges thanks to precision contouring of the workpiece
- A homogeneous, smooth surface is produced particularly by the use of the lamellar pressure belt. This prevents unwanted oscillation lines.
- Lower sanding temperatures increase the tool life of the sanding tool.

Applications:

- High-quality sanding finish on a variety of surfaces
- Intermediate lacquer (sealer) sanding and preparation sanding for high gloss
- Solid wood sanding, especially for frame parts

Range of useful grains:

- Fine sanding P120 – 320
- Interim polishing P320 – 1200

acp[®]  mps  2.0+

“If you want the utmost in surface quality from wide-belt sanding, the H-Head is your go-to specialist...”

Johannes Sedlak, Central Sales Surface Processing, HOMAG

Crossbelt Q | ideal for fine grain sizes

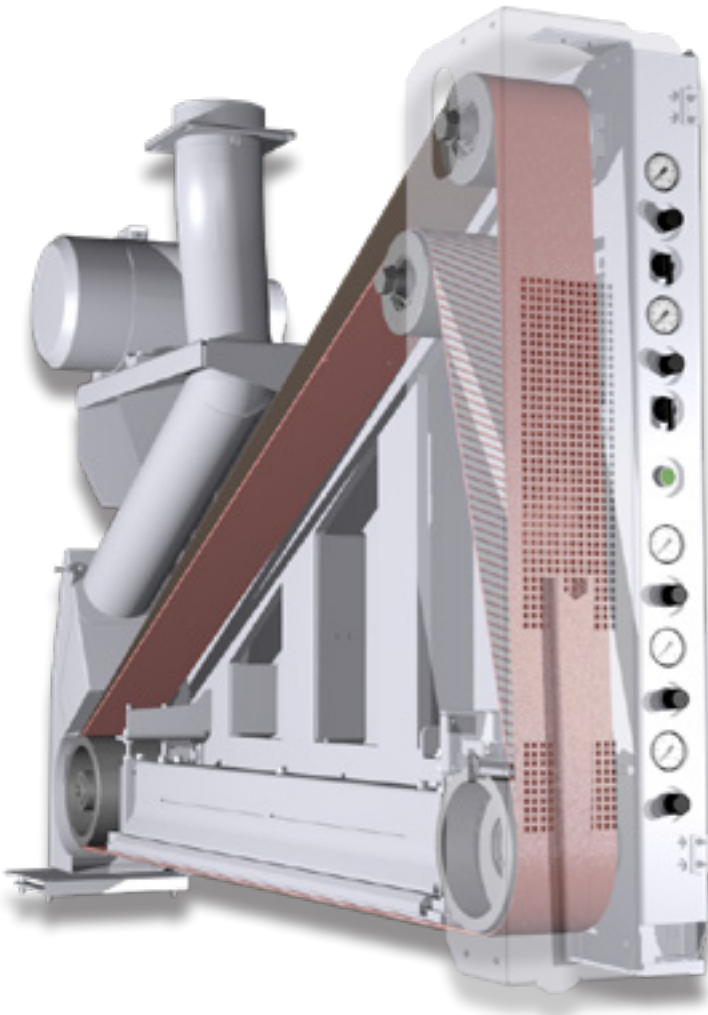

Do you place value on high-quality surfaces? Then you are in the right place. Dieses Aggregat ist für Furnier-, Lack- und Füllerschliff bestens geeignet.

- Long abrasive belt length, ideal for fine grit sizes
- Fibres, tape and glue residue are easily removed by sanding across the grain direction
- Optimum preparation for later coating processes

Applications:

- Veneer sanding, removal of veneer tape or short grain sanding on longer panels
- Intermediate lacquer (sealer) sanding and preparation sanding for high gloss
- Solid wood sanding

Range of useful grains:

- High-gloss paint finish up to grain P2500

mps 

“The cross belt ensures smooth, very high-quality surfaces, with the cut direction rotated by 90°. The ultimate solution for fine sanding in combination with wide-belt head(s)....”

Johann Oestmann, Application Engineering Surface Processing, HOMAG



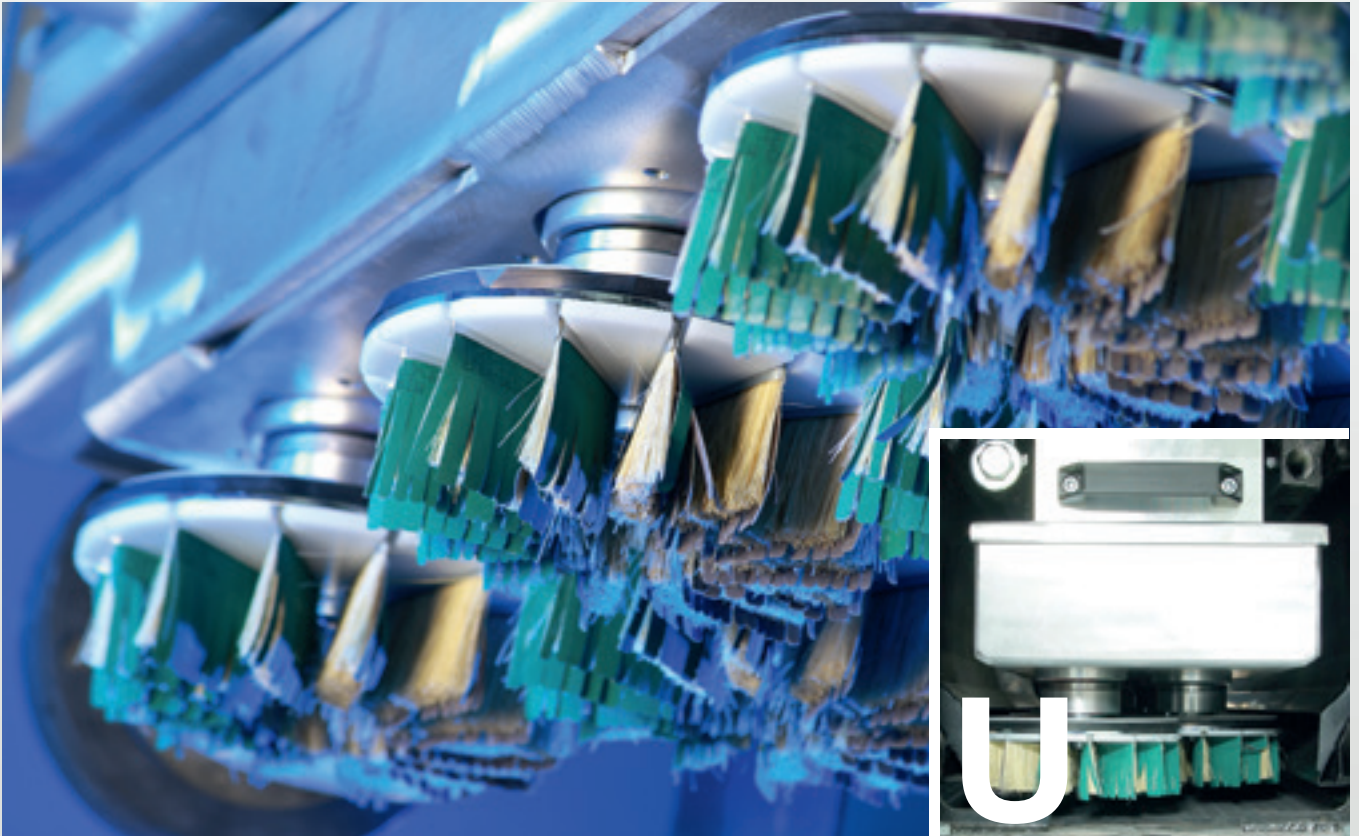

Special heads for that special finish

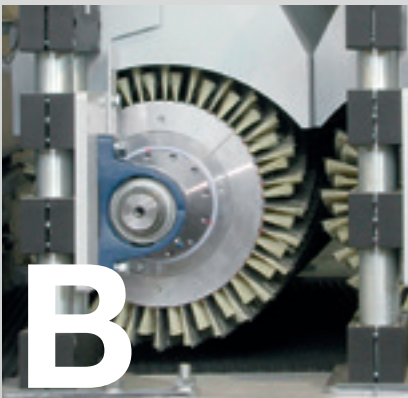

Barrel brush head | 3D finish

- Fine sanding of wood and wood-based materials, as well as painted surfaces
- Refining the sanding pattern of upstream processes
- Suitable for machining three-dimensional workpiece surfaces



Planer head unit M | maximum material removal rate

- Blade shaft unit with a unit with chip removal of up to 2.5 mm
- Four-sided reversible blade

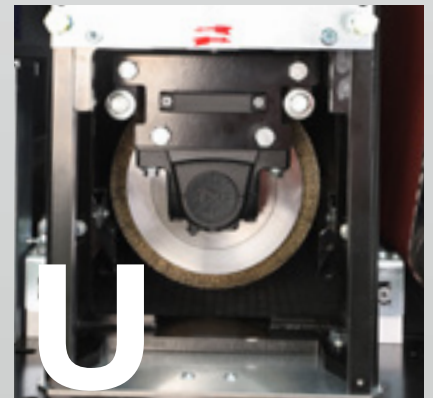

U-Head | variable thanks to quickchange cassette system

- Infinitely variable speed control with or against the feed direction
- Infinite adjustable oscillation
- Easy tool-change thanks to quick-change cassette system between various round and disk brushes
- Program-controlled operation

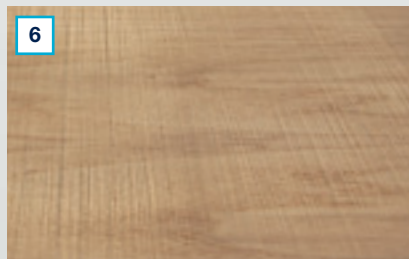
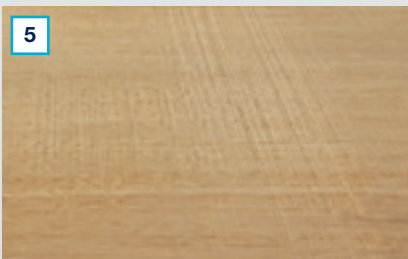

Samples with structured surfaces (1–4) and vintage designs (5–6)

The existing structures in the wood can be given additional emphasis with the pneumatically adjustable brush head, 150 mm diameter.

The U-head with quick-change function can be used to create a variety of surface structures thanks to the use of stranded wire brushes with different wire diameters and abrasive nylon brushes. All parameters for the different results can be stored in the sanding programs and reproduced at any time.

Combining a transverse band with the vintage program can create a rough sawn effect on workpieces. The proportion of the surface and intensity in the sanding program can also be saved here.

THE HIGHLIGHTS:

40 cm in diameter for round brushes B

7 structuring brush edging heads with a maximum diameter of 300 mm available as standard

3 minutes to change a cassette

10 disks in a 1350 mm disk brush cassette



Everything under control with the SANDTEQ W-900 operating concept

Fine sanding, lacquer sanding, calibrating, veneer sanding, improving, roughening of surfaces and many more – the heads for the series SANDTEQ W-900 provide all functions you require for your daily work and ensure a perfect processing result. They can be individually combined according to your requirements for the machine.





Fine workpiece detection with system 12,5

A perfect team: mps 2.0 plus – the magnetic pressure beam system

In addition to the actuators for matching the sanding pressure, workpiece detection plays a significant role. The following applies here: The more accurately the workpiece geometry is recorded, the better. As a result, we use a

12.5 mm system for detection in our mps 2.0 plus system! The very fine workpiece detection, coupled with our rapid and frictionless magnetic pressure beam system gives you assurance in the sanding process.

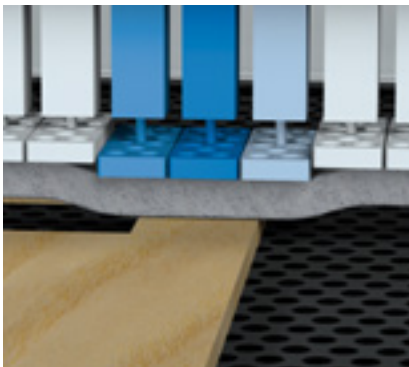
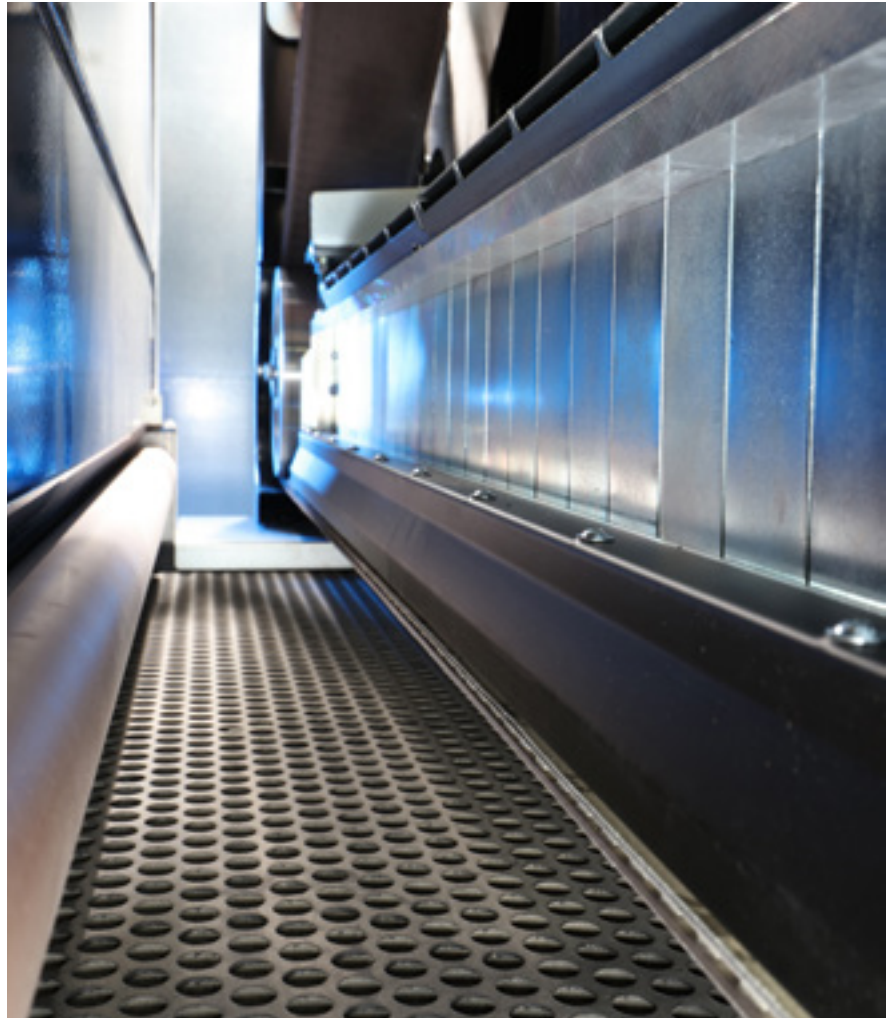

Benefits:

- Workpiece detection in a 12.5-mm system
- High-precision triggering of actuators (sanding segments), repeat accuracy on the front and rear edges and with proportional power flow along the long edges: ensures best sanding results right to the edge
- No frictional losses from the actuators (sanding segments), precise fitting guides ensure the actuators work quickly and without wear
- Individual programming for the most complex sanding tasks
- mps 2.0 plus – magnetic pad system plus for perfectly adjusting the sanding force especially on particularly complex workpiece contours

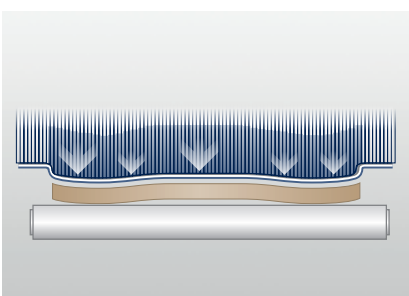

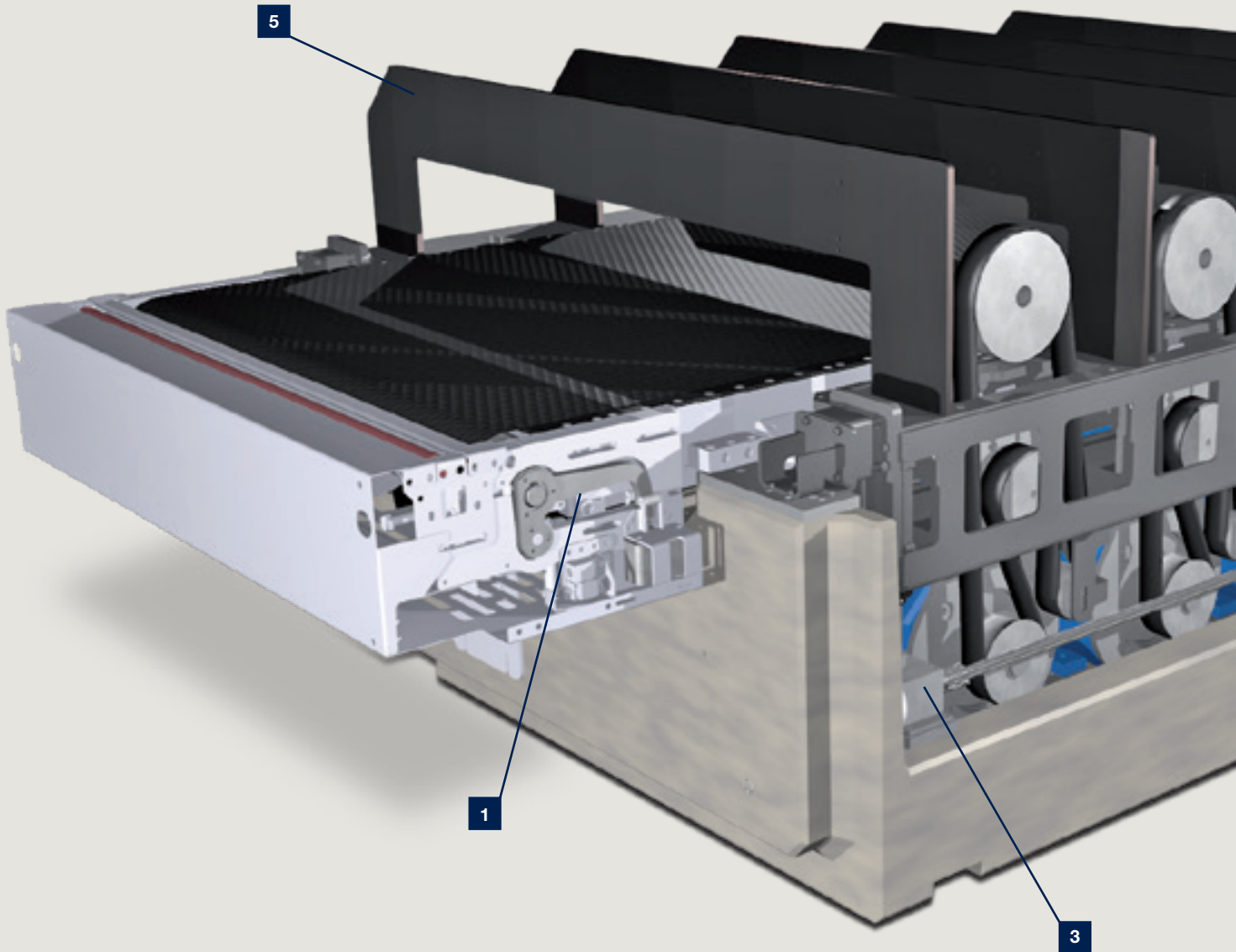

SORB TECH – patented technology for unique quiet running

The patented composite material SORB TECH is characterized by an outstanding and fast vibration absorption, which is even superior to welded frame and cast iron constructions. Vibrations are much faster compensated by about 80 % than with conventional steel constructions. Thus SORB TECH allows an all-time unique quiet running leading to even better processing results.

The exclusive SORB TECH technology has been patented and worldwide it is only available within the HOMAG Group. The SANDTEQ W-900 Wide-Belt Sanding Machines include SORB TECH already as standard.

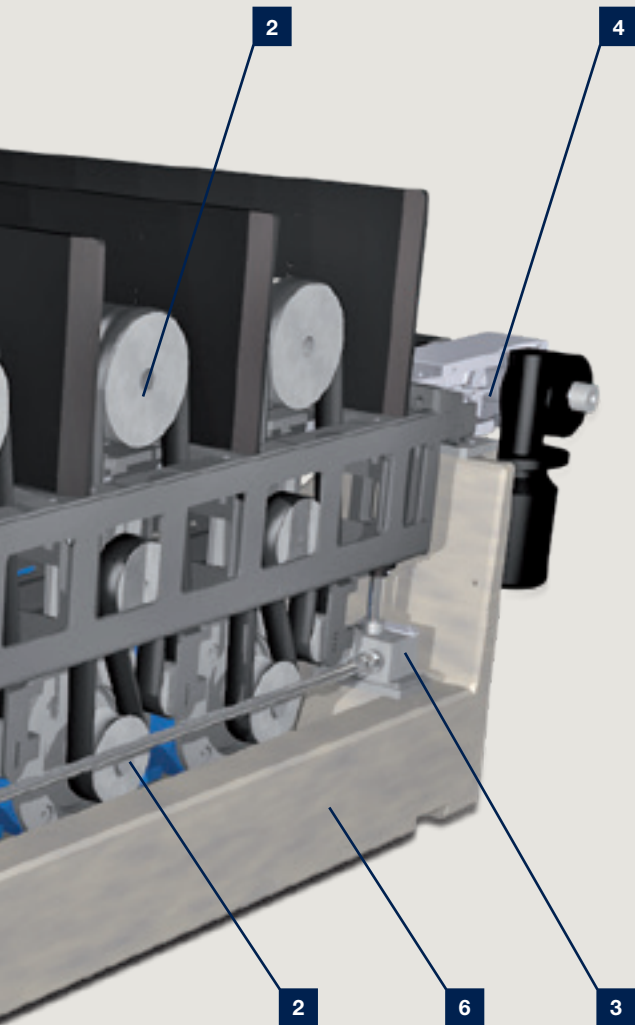

- 1** Feed belt control
Two-sided control with non-contact monitoring and mechanic emergency stop. Low mechanic charge by special design provides for a long-life cycle and quietness.
- 2** Main drive head
Main drives with Poly V-belts for optimum and low vibration power transmission. Constant belt tension avoids vibrations. The motors are directly mounted on to fibre reinforced incorporated metal blocks.
- 3** Height adjustment of the heads
The height adjustment of the heads via lifting spindle gears guarantees a fast positioning speed at simultaneous precision.
- 4** Fixing of feed
The feed is directly connected with the cast mineral via cast-in anchors. This guarantees precision and quietness even under extreme charge.
- 5** Steel cross bars
They are situated between the head carrying main cross bars for maximum stabilisation of the whole construction.
- 6** SORB TECH
Fibre-reinforced cast mineral of which the basic machine is casted. Extreme load capacity and fast vibration absorptions ensure highest processing quality.

All inclusive

With the SANDTEQ W-900, you have TOP equipment from the start. Elementary technologies that ensure lasting first-class processing quality are included as standard.



powerTouch operating panel

- Intuitive touch operation on the machine
- Full-HD multitouch display with wide screen 16:9
- USB interface on front and Ethernet connection 10/100 Mbit



Solid guidance by spring-loaded pressure rollers

- Eccentrically guided, adjustable pressure rollers for perfect guidance at high feed speeds and minimum wear



Standard highlights include:

- Constant working height
- Frequency-controlled, infinitely variable feed
- Maintenance-free, electronic brake assembly
- Prepared slots for retrofitting various brushing and cleaning heads

Contactless sanding belt oscillation

- Contact-free oscillation control for keeping the abrasive belt on track
- Optical system to control the belt edge

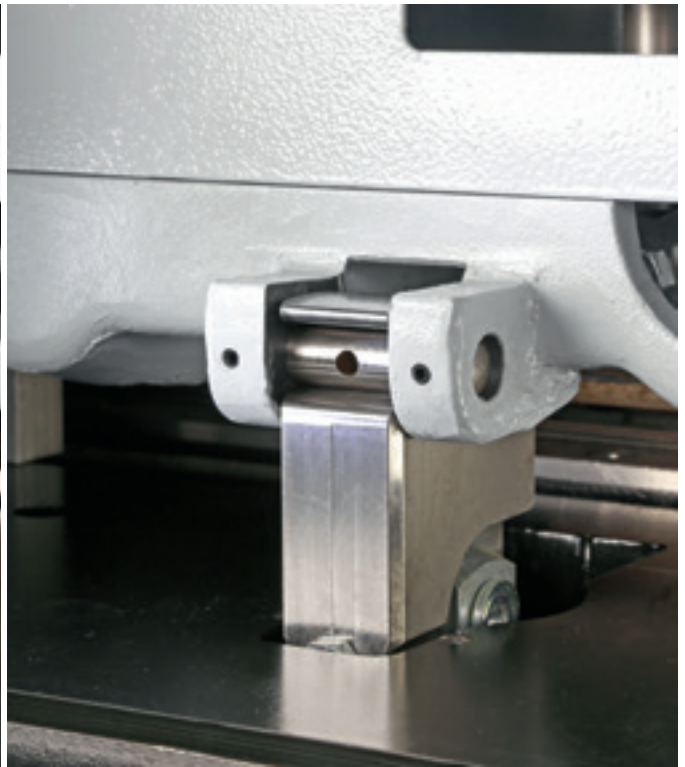
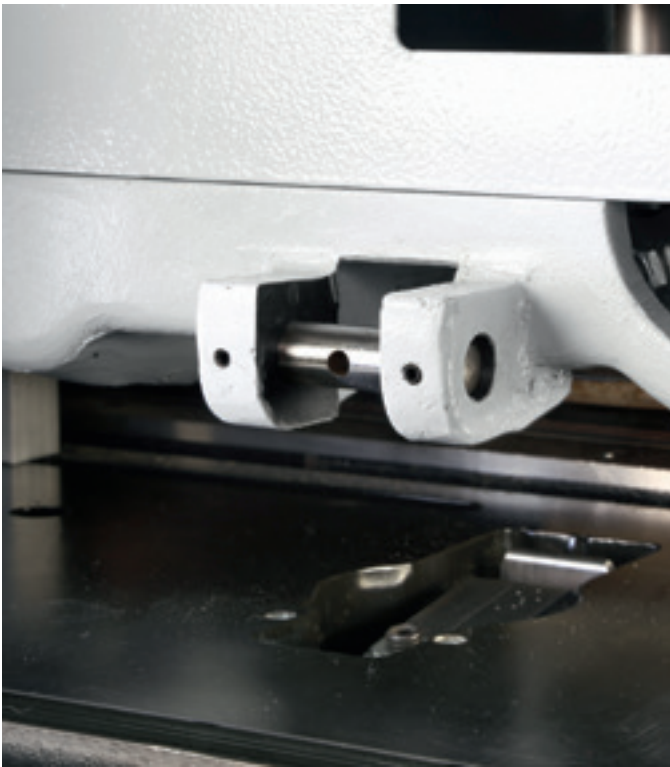

Automatic head locking

- The head automatically locks and unlocks when the door is closed
- Automatic unlocking makes it possible to change the belt more quickly

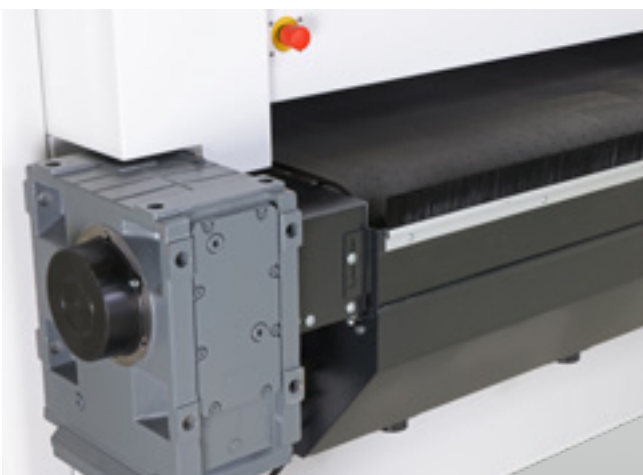

Frequency-controlled, infinitely variable feed

- Transport unit in the extended version for easier integration in interlinking systems (high-quality conveyor belt, large, high-torque and rubberized drive pulley)



Feed belt control

- Continuous adjustment of feed speed
- Position of belt remains central
- Assurance of processing quality

Optional extras that are really worth it!

Would you like something extra? With our optional extras, you have all options you need to adapt your wide-belt sanding machine to the requirements of your production.

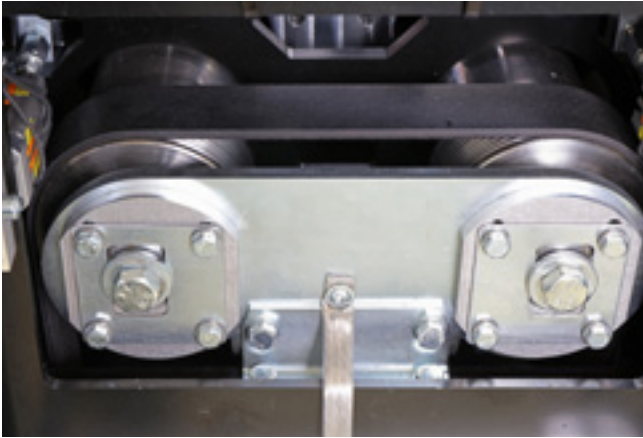

Infinitely variable control of the cutting speed

- Speed control via the frequency converter
- Power transmission via Poly-V-belts.



Vacuum table for secure part feeding

- High-performance fan built into the machine frame with flow control valve
- Activatable table segmentation



External switch cabinets

- An external switch cabinet is available on request
- Simplified and fast access to all electronic units

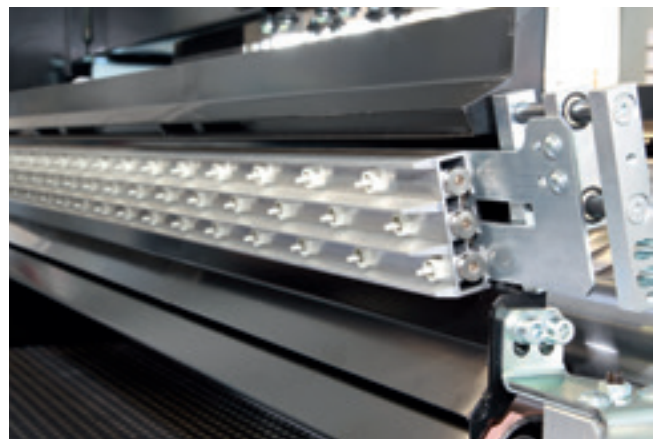

Sanding heads with air-jet belt cleaners

- Pneumatic oscillating air-jet belt cleaning device with integrated dust hood
- Activated by the workpiece, with programmed stopping time, protecting resources



Workpiece cleaning rotors

- Workpiece cleaning using rotating blow-off sprayers
- available in combination with De-ionization bar to reduce static charge for better workpiece cleaning



Extension of applicable belt length from 2620 to 3250 mm

- Reduces the total amount of required belt changes
- Including extractable handling device for easier and faster belt change



ME 5000 thickness measuring device with wireless transmission

- Faster measuring process incl. data transmission into the system
- Cable-free transmission of workpiece thickness measurements to the machine
- Various measuring modes

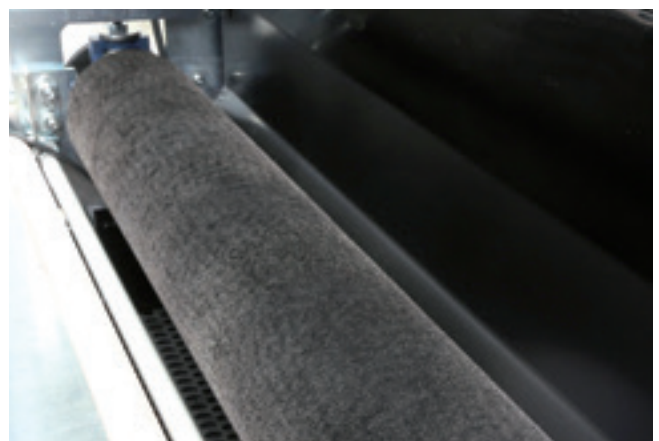

Powered finishing brush

- Cleans workpieces directly after processing ready for further processing



The next generation of powerTouch: **powerTouch2**

Faster, clearer, easier to use: reap the benefits of our powerTouch touch user interface, which has been developed further. We have optimized our standardized operating concept further and adapted it to the needs of our customers. You can now control your HOMAG machines more quickly and more intuitively. The new and contemporary

design is clearly structured. The innovative touch operation is designed to enable you to get the desired result easily and comfortably.

Our successful powerTouch philosophy – **standardized, simple, ergonomic, evolutionary** – consistently further developed

OVERVIEW OF THE HIGHLIGHTS:

- Direct and efficient operation, up to 30% faster
- More informative and more transparent thanks to additional information and live preview images instead of program icons
- New applications for operating and controlling machines and plants (e.g. NCCenter in a PC87 control system for CNC machines, or woodCommander 4 for throughfeed machines).
- Fresh, attractive design based on the new HOMAG machine design





Clearer structure

The structure of the powerTouch2 screen is even clearer. You only see the information that is relevant for you. The important points at a glance – but you still have all the details. All in a fresh, attractive design.

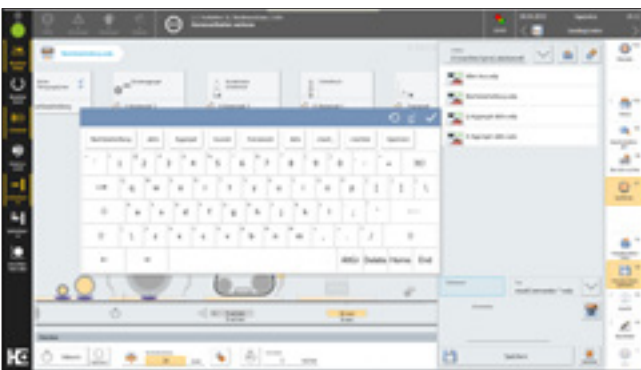

Even faster

With the new powerTouch generation, you can enter information at your machine even more quickly. Compared to the previous version, you can achieve a time saving of up to 30%. This is all possible thanks to new features, such as automatic word completion, a pop-up keyboard that can be kept open, and Windows-like functions such as the ability to select frequently used actions directly via the start button.

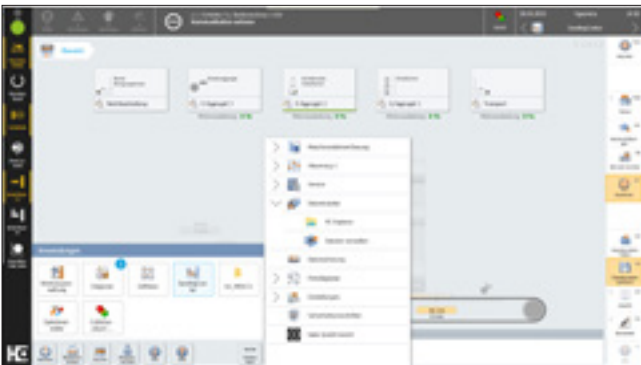

More comfortable

We have also improved the traffic light dialog and the "Start" menu. When you press and hold the program icon, not only are the possible actions displayed, you can also access and activate them directly. Operation is therefore immediate and you do not lose any time opening applications. What's more, for the applications, illustrations and additional information can be displayed instead of simple program icons. This also provides more transparency and avoids unnecessary navigation into applications.



More intuitive

Operating the machine is child's play. Many of the functions are similar to those of a smartphone or tablet and will therefore be familiar to you. Even beginners will feel immediately at ease and will soon be able to control the machine comfortably.

Easy to get. And easy to use.

tapio is the open wood industry ecosystem

This means that everyone involved in the wood industry can participate.
Because together with our business partners, we develop digital solutions for everyone.



Just have a try:

MachineBoard is available immediately free of charge for HOMAG machines! To use MachineBoard, all you need to do is register with tapio and ensure the machines are connected — which you can do easily at www.tapio.one.

Apps that make working life easier

tapio

Partner

DataSave

- Protects machine and configuration expertise
- Faster service for machine breakdowns
- Saves time when restarting production
- Saves on maintenance costs
- Automatic backups of several machines

ServiceBoard

- Create service cases quickly and easily and send them to the correct service partner
- Live video diagnostics to solve service cases with image support
- Video reduces the language and distance barriers
- Also works without a machine connection to tapio (and is therefore ideal for older machines)

MachineBoard

- Push notifications
- Machine data and status can be viewed from anywhere in real time
- Lists of errors, warnings, maintenance tasks and actions
- Displays the remaining time until the next intervention by the machine operator



Free demo for all tapio apps, no registration required. Simply download and test.

Currently available in the EU and Switzerland.

(Due to the fast pace of the IT-landscape, the compatibility to the tapio platform is warranted for five years.)



Modern sanding line – Combination of surface processing from top and bottom

The Wide-Belt Sanding Machines SANDTEQ W-900 and SANDTEQ B-700 can be combined with each other and thus easily offer sanding from top and bottom in one process. For a continuous transport of the workpiece they can be directly connected. Alternatively, a connection via an intermediate transport belt is possible. One of the many advantages of this is that it makes the machines more accessible. The modern

sanding line possesses an external switch cabinet and requires just one terminal for the complete control. Here it is, however, possible to enter separate data for every machine. The inclined installation of the bottom sanding heads of the SANDTEQ B-700 offer a working height of 900 mm and provide an even higher operational safety than heads in triangle positioning.

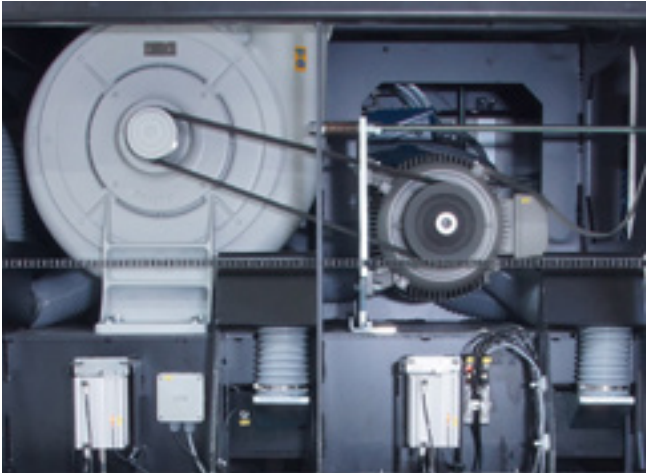

For the SANDTEQ B-700 the bottom sanding heads E, R and M can be used.

Compared to conventional systems, belt cleaning and dust removal are considerably more efficient with the SANDTEQ B-700.

Technical data:

These series cover a wide range of applications. The SANDTEQ W-900 with 2–5 heads and 1350 mm or 1650 mm working width can be configured for all manner of applications.



SANDTEQ W-900								
Model	925	935	945	955	926	936	946	956
Number of heads	2	3	4	5	2	3	4	5
Workpiece thickness mm	3 – 160							
Working width mm	1,350				1,650			
Maximum feed speed m/min.	60							
Maximum drive power kW	45							
Maximum machine length mm	2,795	3,295	3,795	4,295	2,795	3,295	3,795	4,295
Machine width mm	2,250				2,550			
Max: machine height with a sanding belt length of 2620 mm	2,535							
Max. machine height with a sanding belt length of 3250 mm	2,850							
Weight approx. kg	8,000	9,000	11,500	15,000	8,500	9,500	12,500	15,500



HC LIFE CYCLE SERVICES

The sale of our machines comes with all-in optimum service backup and individual advice. We support you with service innovations and products which are especially tailored to your requirements. With short response times and fast

customer solutions we guarantee consistently high availability and economic production – over the entire life cycle of your machine.



REMOTE SERVICE

- Hotline support via remote diagnosis by our trained experts regarding control, mechanics and process technology. Thus, more than 92% less on-site service required and consequently a faster solution for you!
- The ServiceBoard App helps to solve tasks in a fast, simple and concrete way. This is achieved by mobile live video diagnosis, automatic sending of service requests or the online spare parts catalog eParts.



SPARE PARTS SERVICE

- High spare parts availability and fast delivery.
- Ensuring quality by predefined spare parts and wear parts kits, comprising original spare parts.
- Identify and inquire for spare parts online under www.eParts.de 24/7, or buy even faster and more comfortably in the new HOMAG eShop (shop.homag.com).



MODERNIZATION

- Keep your machinery up to date and increase your productivity as well as your product quality, This is how you can meet tomorrow's requirements today!
- We support you with upgrades, modernization as well as individual consultancy and developments.



DIGITAL SERVICES

- serviceRemote – the new remote service solution of the future! Fast restart of production because the remote service employee has extensive access to relevant physical data.
- serviceAssist – provides help for self-help. The preventive solutions proposed in the new App are the combination of our experiences and existing machine data.



SOFTWARE

- Telephone support and consultancy through software support.
- Digitalization of your spare parts via 3D scanning saves time and money compared to new programming.
- Subsequent networking of your machinery with intelligent software solutions ranging from construction to production.



FIELD SERVICE

- Increased machine availability and product quality by certified service staff.
- Regular checks through maintenance/inspection guarantee the highest quality of your products.
- We offer you the highest availability of technicians in order to reduce downtimes in case of unpredictable troubles.

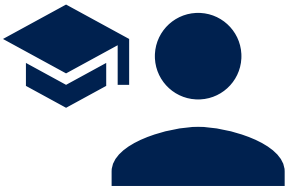
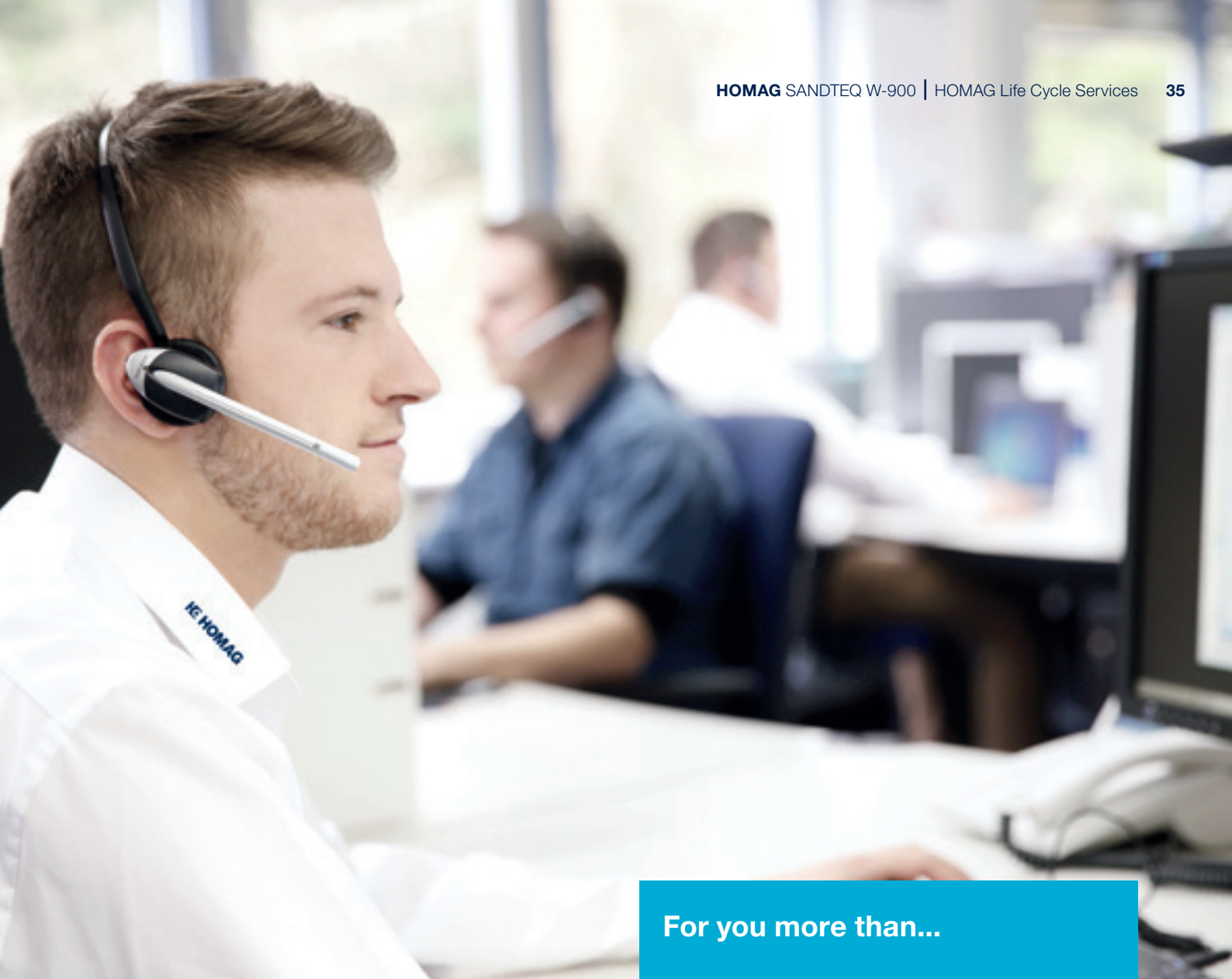

TRAINING

- Thanks to training perfectly suited to your requirements, your machine operators can optimally operate and maintain the HOMAG machines.
- The training also includes customer-specific training documents with exercises proven in practice.
- Online training and webinars. Learn without traveling, meet your trainer in the digital classroom.

For you more than...

1,350

service employees worldwide

92%

less on-site service thanks to successful remote diagnosis

5,000

customer training sessions per / year

150,000

machines, all electronically documented in 28 different languages - in eParts.

HOMAG Group AG

info@homag.com

www.homag.com



YOUR SOLUTION