

Processing centre

# Venture 13/15



## Process without BAZ

Time / Labour costs / Transport / Space

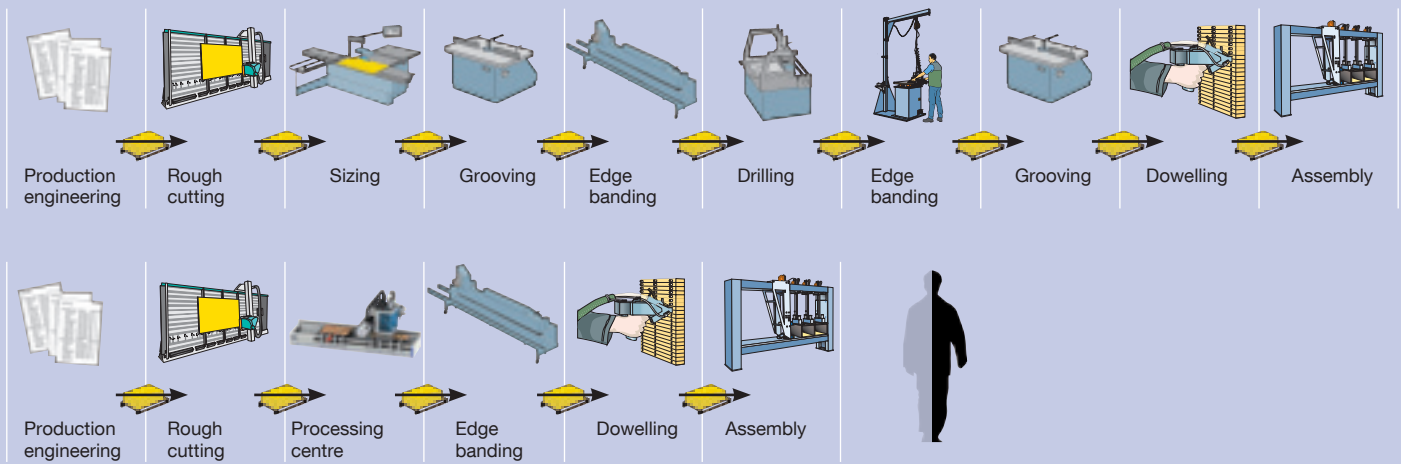

## Process with BAZ

Time / Labour costs / Transport / Space

## Where efficiency matters

HOMAG processing centre users profit from a whole range of benefits. Its multifunctionality makes for extremely flexible application. Which means more efficient production. The high standard of processing quality permits faster production of standard components and complex parts. Which improves your delivery capability. The Venture allows you to offer bespoke processing operations as standard. This performance advantage over

“conventional processing” means you generate more profit. And your advantage over your competitors also extends to product design and quality. Innovative production functionality with features such as the new **easyEdge** edge banding unit places you right at the cutting edge. And last but not least: You gain the assurance of outstanding investment security, as your processing centre with its units and clamps is designed for adaptation to future production needs.

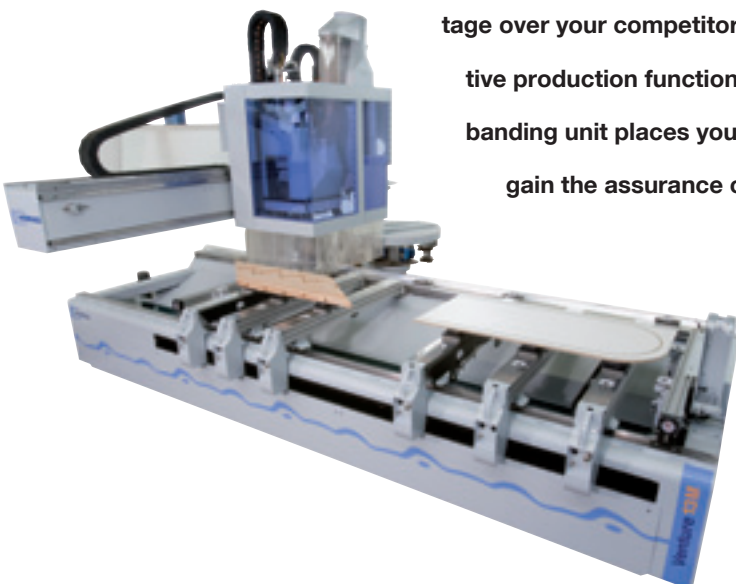



### Production instead of transportation

By collating several work steps, you save up to:

- 50 % labour costs
- 30 % transport and sorting expense
- 30 % set-up times
- 20 % surface area

You additionally reduce transport damage and expense for production engineering



### High degree of utilization, low costs

The collation of work steps, good capacity utilization and low energy consumption add up to a low machine hour rate on the processing centre.



### Consistently high precision

A processing centre always guarantees optimum processing quality to a consistently high standard of quality. The rapid, precise post-processing of reject parts ensures adherence to promised delivery dates.



### Data transfer from CAD systems and trade-specific software packages

For the generation of CNC programs, all data can be transferred from your CAD or the trade-specific software - quickly, simply and without cost duplication.

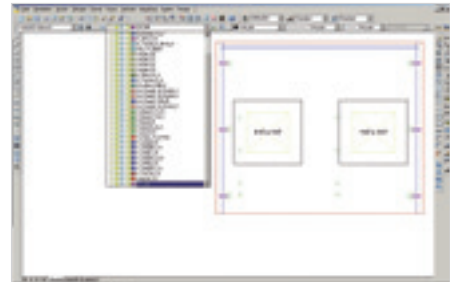

### Product design "unlimited"

Thanks to variable feed rates and rotation speeds coupled with minimal production tolerance, different materials and individual designs are produced quickly and to an outstanding standard of quality.



### Processing centre as a standard necessity

Economical in-house production is inconceivable nowadays without the use of a processing centre. Motivated employees safeguard the future of their company through innovative technology.



### User convenience

Learning how to operate and program a processing centre is not as complicated as you might think, and will ideally prepare you to meet future challenges.

# High-end features – all inclusive

More than 1,000 processing centres leave our production halls each year. This experience is reflected in the wealth of ingenious details in our machines and plants. Because we use many identical components from the **profiLine** category, you benefit from outstanding machine availability for your industrial production. The widespread use of “identical parts” within the HOMAG Group reduces the costs of spare parts and speeds up their delivery. We also offer our customers a complete equipment package which far exceeds the standard scope of supply in the sector.

## Enclosed trailing cable

Enclosed energy chains prevent damage to cables and hoses. This reduces the incidence of faults and possible repair costs.



## Rack and pinion drive

The highly dynamic low-vibration rack and pinion drive systems ensure fast processing cycles and result in higher workpiece quality.

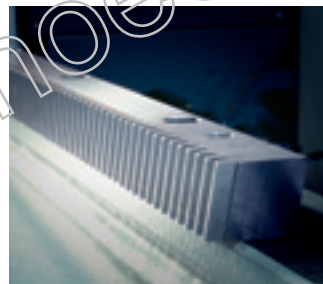

## Linear guide and insertion aid

Simple handling by consoles with high-precision linear guides and durable insertion aids with two pneumatic cylinders. Vacuum and compressed air connections are integrated in the consoles for pneumatic clamps and clamping templates.

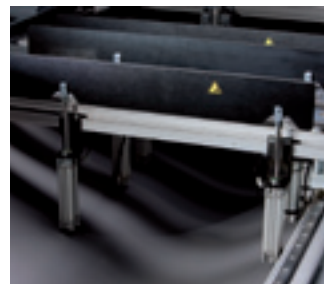

## Bolts with end position scanning and for laminate overhang

Stop bolts with end position monitoring to protect tools, units and machine operating staff. Exchangeable stops specifically for workpieces with laminate overhang.

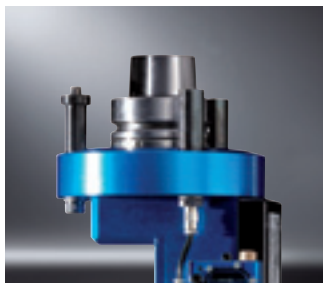

## 3-point support

The retainer for the three bolts of the highly rigid 3-point support simultaneously permits the transmission of compressed air and fluids to the processing units. This is a requirement, for example, for the use of pneumatically traced units.

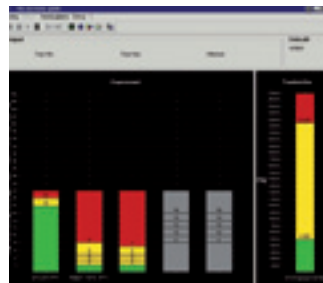

## Fluid cooling and spindle sensor

Fluid-cooled trimming spindles with hybrid bearings offer a long service life. An additional vibration sensor detects tool imbalance and protects the spindles from overload, for example due to excessively high feed rates.

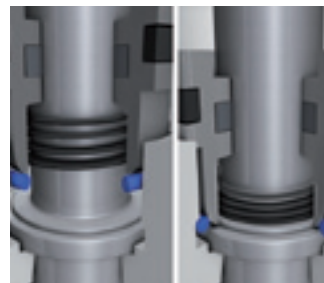

## Drilling head with spindle locking mechanism

Automatic spindle locking mechanism: Patented system for precise drilling depth every time even with different materials. With speeds ranging from 1,500 - 7,500 rpm for high feed rates / short drilling cycles (appr. 1.5 sec.).



## Standby and flap control

Effective extraction with low connected load due to automatic closure of unused suction nozzles. Reduced power consumption due to automatic standby mode of all consumers and vacuum pumps.



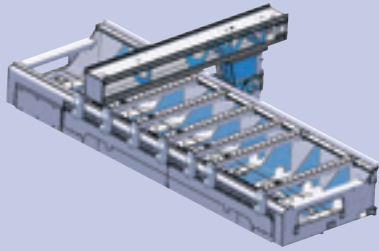

#### High weight, optimum quality

The highly rigid machine construction has a substantial weight of between 9,000 and 11,000 kgs, guaranteeing a high standard of processing quality due to minimal vibrations. This also prolongs the service life of components.

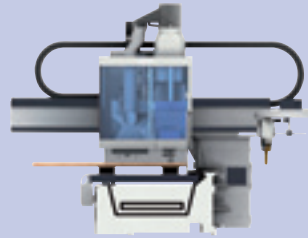

#### Panel overhang

The machine bed support over the entire processing depth guarantees optimum waste piece disposal.

#### Covered linear guides and automatic central lubrication processes

Covered linear guides with closed guide carriage and integrated central lubrication guarantee low-maintenance, reliable operation.

#### Suction cups fitted with double seal

Three hoseless suction cups per console with patented double lip seal for free positioning of any optional number of suction cups.

#### 100 mm suction cup height

The suction cup height permits wide scope for processing the underneath of the workpiece. Processing height 300 mm from upper edge of console and a workpiece length of 230 mm.

#### Two Z axes

Two separate Z axes for drilling head and working spindle permit rapid alternating drilling head and working spindle application. The flow-optimized routing of the extraction channels reduces the required suction output – so saving costs.

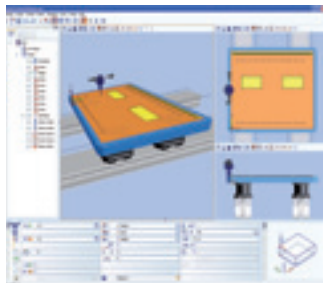
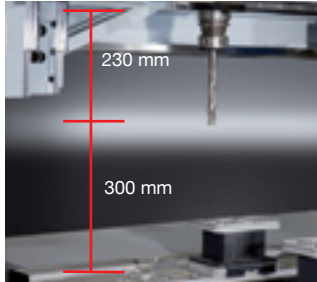
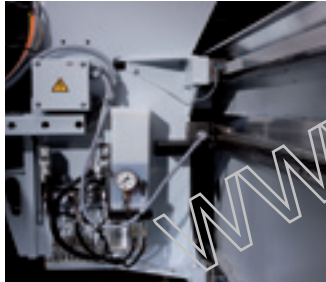

#### Operator terminal

The control unit comprises a 17" TFT screen, CD-RW drive, modem, front USB port, 10/100 Mbit Ethernet connection and an ergonomic control terminal. Integrated rollers allow the switch cabinet position to be freely selected. An integrated fan ensures an optimum operating temperature.

#### woodWOP 6.0

This programming system is the most frequently used in the world. With its 3D design tool woodDesign, it ensures a "short-track" route from the drawing to the finished machine program. With the acquisition of data on produced workpieces and display of maintenance intervals, MDA basic permits optimum utilization of the processing centre.

#### DXF transfer

woodWOP production engineering station – programming from the comfort of the office:

- Programming while ready generated programs are running on the machine
- Data transmission via standard USB port at the machine or over a network connection directly from the office
- woodWOP DXF import – the CAD interface
  - For transfer of workpiece geometries and defined processing operations
  - Data transfer from CAD systems in international DXF format

#### Protection against data loss

Uninterruptible power supply (UPS) to prevent data loss in case of power failure and mains voltage fluctuations. Free remote servicing during the first two years provides optimum support in the event of possible malfunctions.

# Flexibility for furniture production and interior fittings production

Production flexibility is paramount when it comes to the economical production of furniture components: HOMAG machines are capable of coping with wide-ranging furniture component processing operations and also of the optimum processing of differing workpiece geometries and quantities. HOMAG offers a range of highly flexible processing centres guaranteeing a cohesive production process at high speeds coupled with outstanding precision. And with the capability to take tomorrow's requirements easily in its stride.





# Equipment packages to meet all your needs

Select from three equipment packages for your Venture 13/15:

- **Basic** – Your entry into the world of efficient production with a processing centre including the unique facility for combining edge banding and five-axis processing
- **Future** – more convenient and faster through console positioning with LED display and optional FLEX5+ five-axis unit with automatic tool change
- **Performance** – Higher output due to the unique Multi Processing Unit – one drilling head capable of sawing, trimming and drilling at any angle and without resetting times

Equipment variants	Trimming spindle	Pneumatic interface	FLEX5/FLEX5+
	<p>Working spindle (15 kW) with controlled spindle speeds of 1.000-24.000 rpm for extremely high torque even at low speeds, for example when sanding.</p>	<p>The transmission of compressed air of fluids to the processing units permits the use of e.g. traced units or the easyEdge gluing unit.</p>	<p>The integrated FLEX5 interface allows the FLEX5 unit to be retrofitted with automatic angle adjustment. For precise execution of shift cuts or boreholes and trimming at "any" angle without manual setting processes.</p>
<b>Basic</b>			
<b>Future</b>			
<b>Performance</b>			





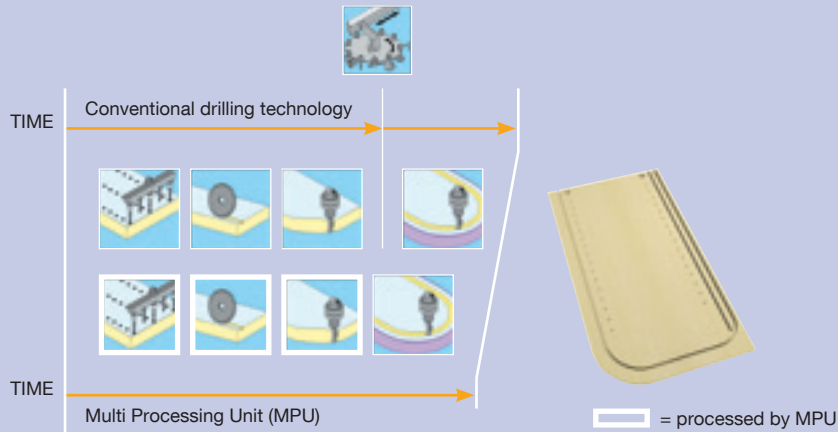





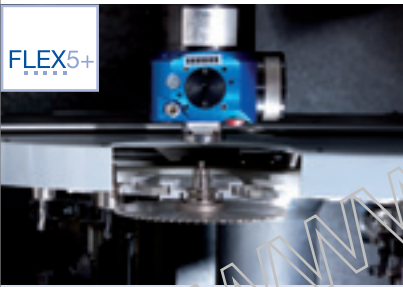

The multifunctional character of the Multi Processing Unit permits sizing, sawing and drilling without tool change. As the MPU can be swivelled around 360°, processing operations can be carried out at “any” angle. During application of the MPU, tools can be exchanged into the working spindle. Downtimes are drastically reduced, in favour of higher productivity and lower piece costs.



interface	Drilling head		
<p>The ultimate in flexibility – the FLEX5+ interface forms the basis for use of the FLEX5+ unit. Precise processing operations at any angle in conjunction with automatic tool change. A unique feature covering over 90% of five-axis applications.</p>	<p>HIGH-SPEED drilling head 7,500 with 12 vertical spindles, grooving saw and four horizontal spindles with 0/90° swivel action. Ideal for fast drilling operations and grooving without tool change across the entire processing depth of over 1.550/1.850 mm.</p>	<p>HIGH-SPEED drilling head 7,500 with 17 vertical spindles, grooving saw and four horizontal spindles with 0/90° swivel action. Fewer drilling cycles including grooving in X/Y direction over the entire work area.</p>	<p>Multi Processing Unit (MPU) with its own 360° swivel axis for drilling and sawing at any angle. 30 drilling spindles and the 200 mm dia. saw provide the ideal basis for fast complete processing without tool change. Optionally with 6 kW supplementary spindle to increase the processing depth by 590 mm to 2,140/2,440 mm.</p>
			
 			













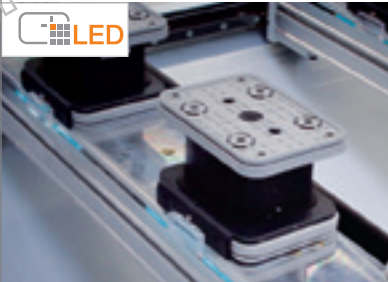

No.	Part	Time
1	Panel	
	Contour trimming	
	Edge banding	
	Edge finishing (flush trimming) and edge snipping	
2	Carcase sides	
	Construction hole vert. (4 cycles)	
	Series holes (6 cycles)	
	Rear wall groove (grooving saw)	
1	Central wall	
	Construction holes horiz. (12 cycles)	
	Series holes (6 cycles)	
2	Top / base	
	Construction holes horiz. (12 cycles)	
	Construction holes vert. (2 cycles)	
	Rear wall groove (grooving saw)	
	Fastening holes - legs/spacer (4 cycles)	
4	Doors	
	Cup hinge holes	
	Handle hole drilling	
	Total:	

appr. 7 min.

#### Time calculation Venture 13/15 Basic

The specified values refer to pure processing times and do not include any set-up times. The edges on the “straight” sides are banded later on a throughfeed machine.



Quick-change system	Set-up aids		
<p>Patented quick-change system for drill bit changing without tools to reduce set-up times</p>	<p>woodWOP automatically determines the optimum positioning for the suction cups taking account of the workpiece dimensions and processing operations. These are displayed using the laser beam (cross hairs). The workpiece contour can be "travelled" as a positioning aid for free-form parts.</p>	<p>LED displays for simple, high-speed positioning of the vacuum clamps and consoles. Up to 70 % time savings for set-up and monitoring correct positioning "at a glance".</p>	<p>Fast plate changer with 12 large slots for tools and units with a diameter of up to 180 mm.</p>
			
			
			
			

**Performance increase using the equipment variants**



**Basic**  
appr. 7 minutes processing time

**Future**  
10 % more output due to:  
• Faster set-up with LED  
Greater flexibility through:  
• Automatic tool change with FLEX5+  
• Larger tool store (less set-up work)

**Performance**  
20 % more output due to:  
• Higher feed rates with high spindle output  
• Faster set-up with LED  
• Fewer tool changes due to use of MPU  
• Tool change while MPU is in use  
Greater flexibility through:  
• Automatic tool change with FLEX5+  
• Larger tool store (less set-up work)

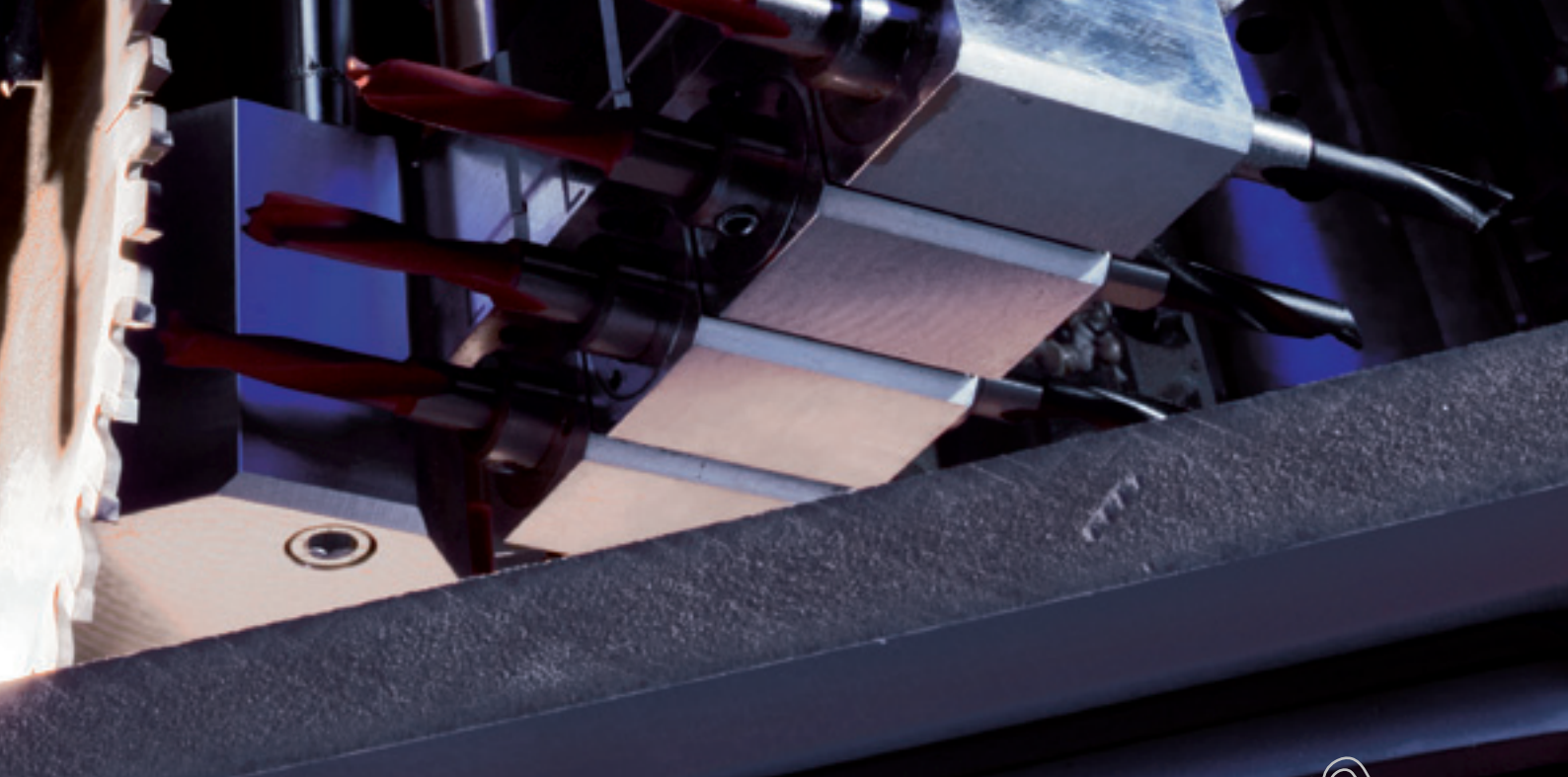

## Tool changer

14-slot plate changer for tools and units with a diameter of up to 200 mm. Due to bottom arrangement of the changer, tool change is also possible using FLEX5+ (option).

Additional 10-slot plate changer for tools and units permits tool change while the MPU is in use. In conjunction with the 14-slot changer, 24 tools and units can be used without manual intervention.

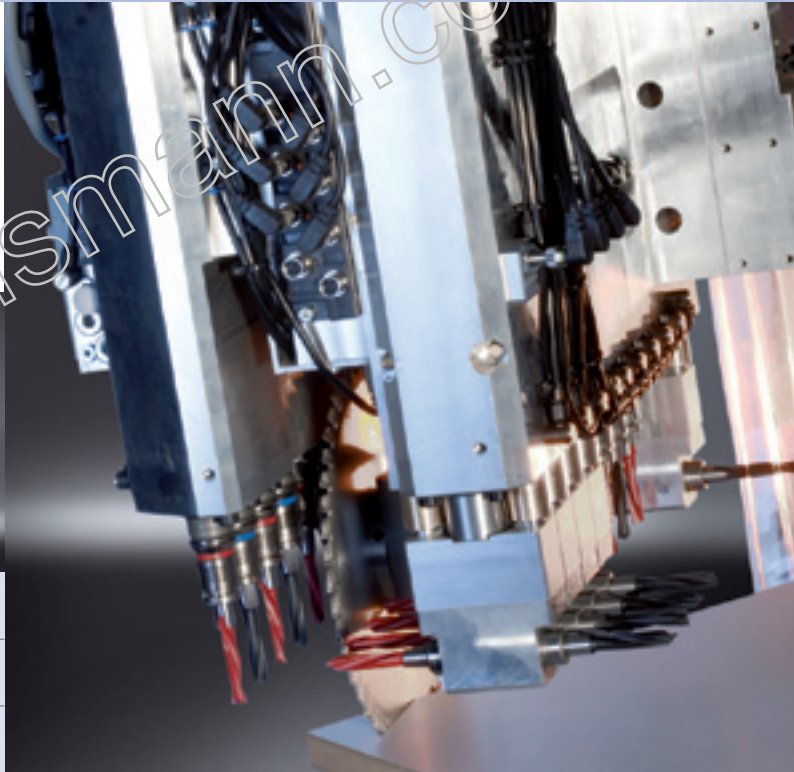
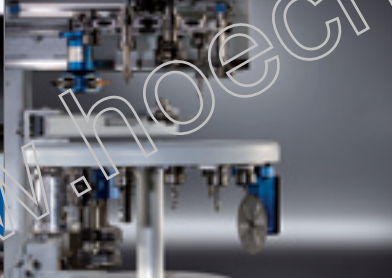
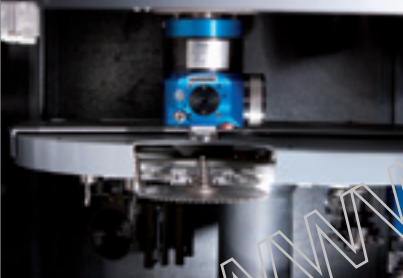

## Premium software package Venture (optional):

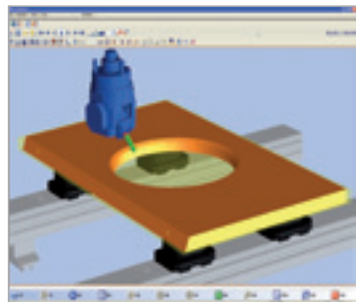

### woodMotion

Graphic simulation of the CNC program at the office PC:

- 3D view, free positioning, rotation and zooming
- Stock removal and waste piece detection
- Collision monitoring between the tool and clamping elements
- Inclusive of 4 licences for your PCs in Production Engineering

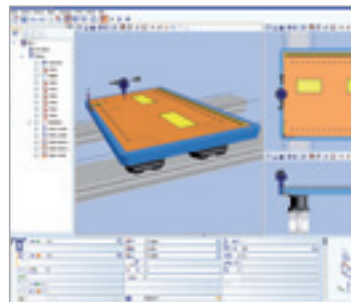

### Additional woodWOP licences

- 3 additional licences for your PCs in Production Engineering
- Inclusive of CAD data transfer in DXF format

# Unlimited opportunities for future assignments

A HOMAG processing centre is a decision for the future. You will go on profiting in the long term. Because your Venture grows flexibly step by step with your requirements. With its complementary processing units, clamps and software, you will always have the ideal production technology to address your changing needs. The sound backing of competence behind the HOMAG Group and our worldwide servicing network are your assurance of an investment which pays dividends.

For additional software packages, please request our brochure "Software for processing centres".

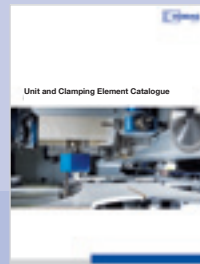
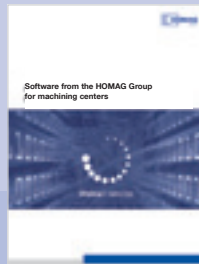

For other applications, please request for our processing unit and clamping fixture catalogue.

## easyEdge gluing package

easyEdge gluing unit for efficient banding of edges on shaped components. Ideal as a package solution with the combination flush trimming and scraping unit.



## Maxi-Flex clamping system

Maxi-Flex clamping system for flexible clamping of shaped components.



## Matrix adapter plate

Versatile adapter plate for nesting applications and also for clamping small components with individual shaping.

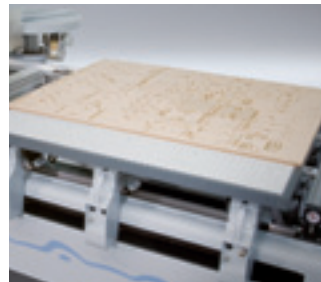

## Sawing and snipping unit

Snipping cuts during edge banding are one of the strengths of this unit. The position of the saw blade in the centre of the C axis ensures extreme precision. All other sawing operations can naturally also be performed up to a cutting depth of 65 mm.

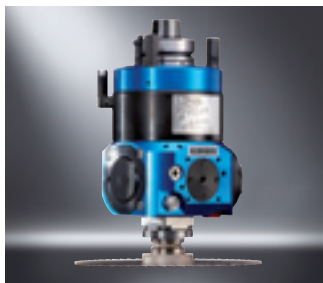

## FLEX5+ sawing, trimming and drilling unit with automatic angle setting

The FLEX5+ unit offers not only automatic angle adjustment but also automatic tool change. This allows the complete processing of wide-ranging workpieces such as pyramids without the need for manual intervention. Both the cutting and grooving / dowel hole drilling processes are performed to a high level of precision. Depending on the A axis, cutting depths of up to 60 mm are possible, as well as drilling operations with a useful tool length of 60 mm (basic equipment: FLEX5 without automatic tool change).



## Lock case trimming unit High performance with 2 tool holders

For heavy-duty trimming operations with high feed rates, also in hard woods, for example for front door production or paling hole trimming in staircase construction. Chip disposal is supported by the integrated air jet. The two tools with a maximum useful length of 130 mm / 50 mm respectively permit streamlined production without tool change.



## Horizontal trimming unit

Highly rigid tool bearing permits smoothing for furniture production, sliding dovetail joints for facade construction or handrail profiling for staircase production.



## 4-spindle drilling/trimming unit

The 4-sided spindle outlet makes available four different drilling and trimming tools without the need for tool change. Ideal for interior fittings and furniture construction with different connecting and hardware holes. The highly rigid monoblock design and crown wheel gearing (Cylkro gear) permit light-duty trimming operations to be performed. The maximum useful length of tools is 50 mm / 55 mm.

**Individuality and improved performance**

For individually configured cantilever processing centres, series B200/300 is available with a range of highlights such as:

- Automatic workpiece handling system TBA 330
- Automatic positioning AP table
- Aluminium grid table
- Patented double spindle technology

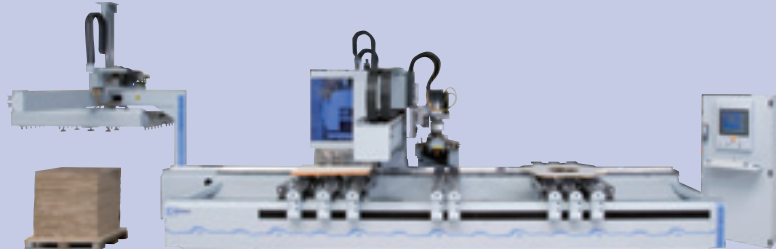

**Tool transfer station**

A tool transfer station enhances operating convenience and ensures greater safety: by preventing errors when loading the tool changer slots.

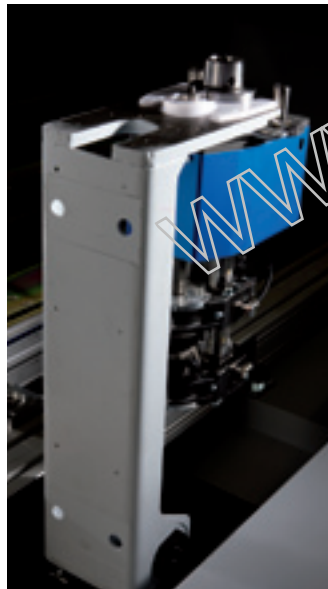

**Chip transport**

Highly rigid machine bed with integrated waste piece collection over the entire processing depth of 1,600 mm. No waste pieces drop in front of the machine (optionally with chip conveyor).



**Barcode**

Automatic accessing of processing programs to match the presented workpiece by means of a bar code reader.



**woodNest – reduction of cutting waste**

- Nesting software für automatic nesting of workpieces on a raw panel
- The nesting process combines the cutting and finish processing operations
- Reduction of material costs and overall processing times

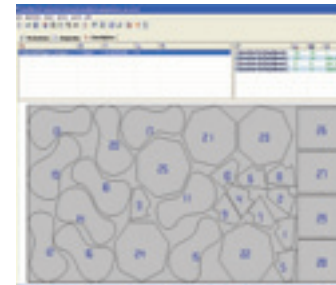

**Machine data acquisition MDA – for a productive environment**

- Registration of piece numbers and ACTUAL operating times at the machine
- Integrated maintenance indication for optimum planning and execution of necessary maintenance work
- Optional professional version permits detailed breakdown and logging of registered data

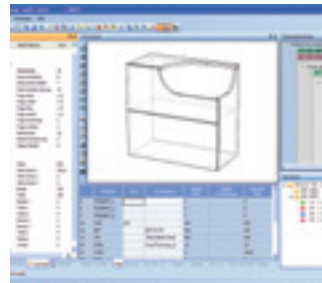

**Interface to trade-specific software**

- For trouble free linkup of trade-specific software packages
- For transfer of already existing data from production engineering
- Countless links to all reputable room planning systems, window trade-specific software, staircase software, CAD/CAM systems and ERP/MRP systems



**Tool service life determination – for a complete overview**

- Module for monitoring and documentation of tool service life
- Machine availability and workpiece quality are enhanced by the timely exchange of tools
- Cost reduction through optimum planning of tool deployment and comparative analysis of tool life

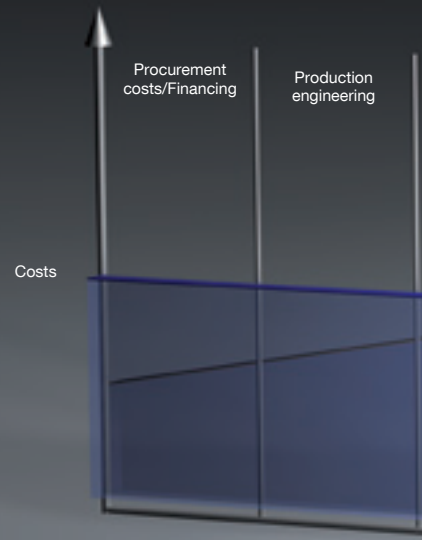

## LifeCycle Cost reduces unit costs



### Unit cost reduction through optimum financing

- HOMAG Finance offers optimized financing concepts based on individual business administration requirements
- The outstanding value stability of HOMAG processing centres offers benefits in terms of leasing and subsequent replacement investment

### Effective production engineering

- Links to trade-specific software packages and CAD/CAM systems reduce program generation times and make use of already existing data
- woodMotion determines processing times for optimum capacity planning and maximum machine time utilization
- Collision monitoring prevents faults by advance testing of programs under "real conditions"

### High level of processing quality "without" finish processing

- A highly rigid machine design reduces vibrations and increases tool service life
- Vibration sensors in the working spindles automatically reduce feed rates under high levels of stress (such as knots in solid wood) or in case of unbalanced tools
- The tool life determination software optimizes tooling costs and ensures optimum workpiece quality (option)

### Low energy costs

- Intelligent stand-by operation reduces energy costs during break times or in case of partial capacity utilization by up to 10 %, saving up to 8,000 kwh of power per year\*
- A flap control system switches the volumetric flow of the extraction system to the processing units actually in use. This cuts up to 20 % of the costs for extraction, corresponding to a saving of up to 12,000 kWh per annum\*
- Cooling of the working spindle by means of water ring vacuum pumps saves an additional 2,000 kwh per year\*



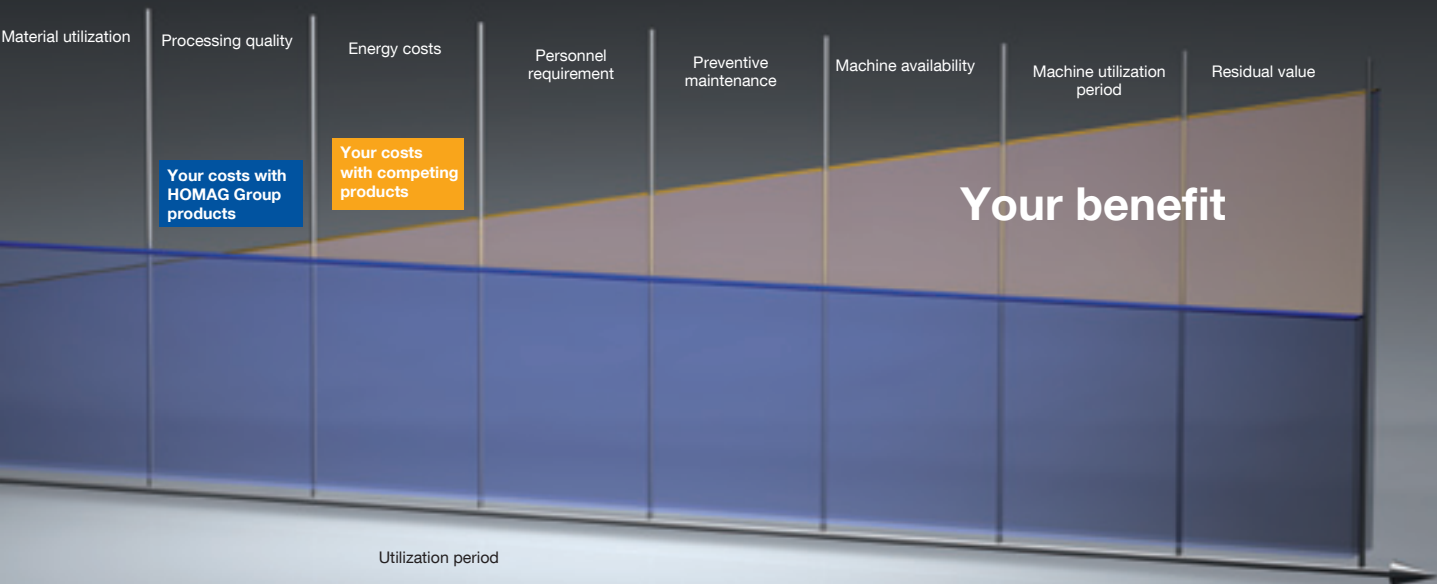

### Reduction of labour costs

- Automatic part handling with robot systems or linear feeders
- Fast, simple operating capability of machines

### Preventive maintenance

- Regular inspections and preventive maintenance help avoid machine faults and extend service life
- MDA software informs the machine operator about scheduled maintenance requirements and provides cost transparency for calculation

### High degree of machine availability

- World-wide service reduces machine downtimes
- TeleServiceNet – our “eye” into the machine eliminates the need for costly service callouts
- woodScout diagnostic software – intelligent self-help for all machine operators

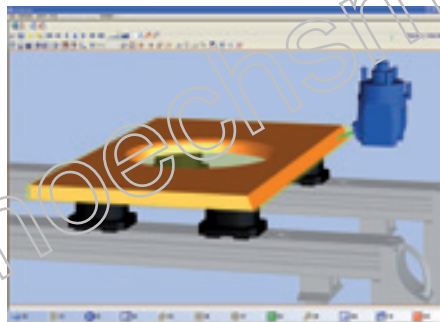

### Machine utilization period

- Facility for continuous upgrading of processing centre functionality using standardized interfaces ensures compliance with future production requirements
- The HOMAG conversion department offers solutions to address major conversion requirements, ensuring a high degree of investment security over years

\* Based on single-shift operation

# Specifications

	X1	X2	X3	Y1	Y2	Y3*
Venture 13M	3,225 mm (127.0")	1,475 mm (58.1")	1,075 mm (42.3")	1,850 mm (72.8")	1,550 mm (61.0")	2,140 mm (84.3")
Venture 13L	4,175 mm (164.4")	1,950 mm (76.8")	1,550 mm (61.0")			
Venture 13XXL	6,175 mm (243.1")	2,950 mm (116.1")	2,550 mm (100.4")			
Venture 15M	3,225 mm (127.0")	1,475 mm (58.1")	1,075 mm (42.3")	2,150 mm (84.6")	1,850 mm (72.8")	2,440 mm (96.1")
Venture 15L	4,175 mm (164.4")	1,950 mm (76.8")	1,550 mm (61.0")			
Venture 15XXL	6,175 mm (243.1")	2,950 mm (116.1")	2,550 mm (100.4")			

Technical data and photos are not binding in every detail. We reserve the express right to make changes in the interests of further development.

\* Only for the **performance** package with optional supplementary spindle.

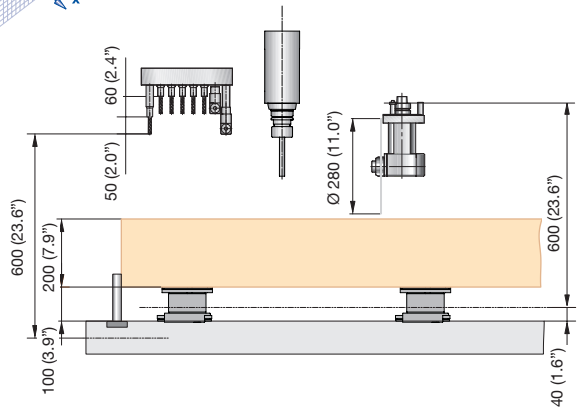
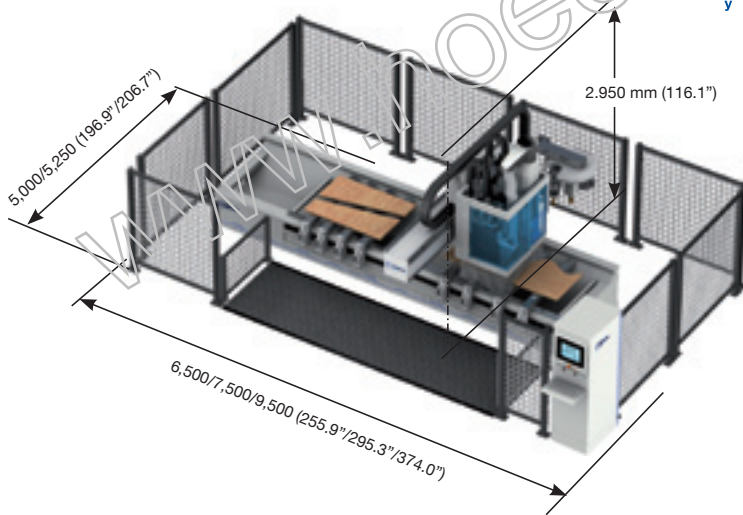
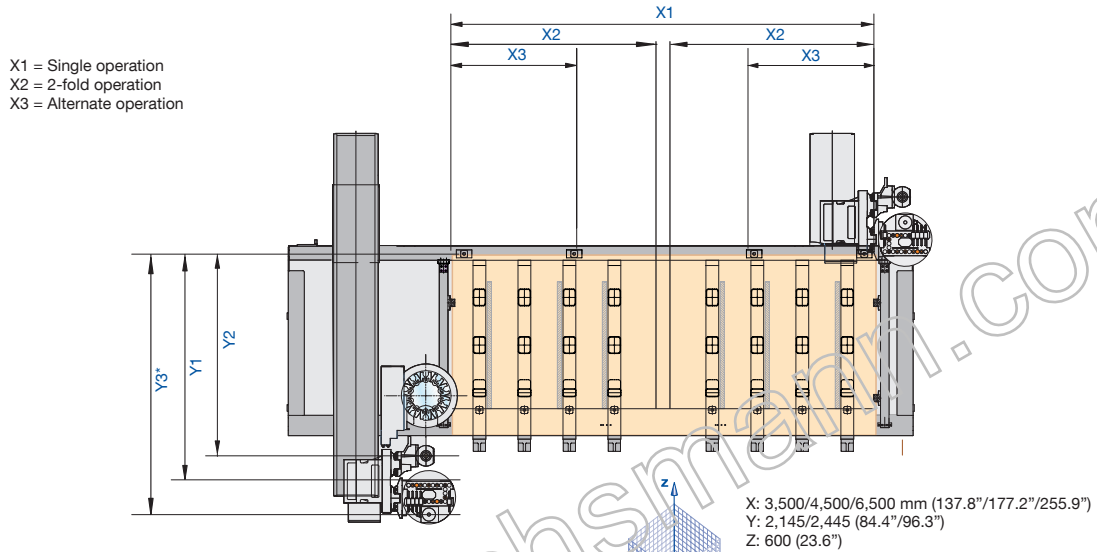

A member of the HOMAG Group



**HOMAG Holzbearbeitungssysteme AG**  
Homagstraße 3–5  
72296 SCHOPFLOCH  
GERMANY  
Tel. +49 7443 13-0  
Fax +49 7443 13-2300  
info@homag.de  
www.homag.com