

GENERAL CATALOGUE

CATALOGUE GENERAL

CATALOGO GENERALE

ormamACCHINE

GESAMTPROSPEKT

CATALOGO GENERAL

PRESSE A FREDDO



Pressa a freddo P 25/2
P 25/2 cold press
Presse a froid P 25/2
Prensa en frio P 25/2
Kaltpresse P 25/2



Pressa a freddo P 25/4 (disponibile anche con piani a caldo PCL 25/4)
P 25/4 cold press (hot version too PCL 25/4)
Presse a froid P 25/4 (disponibile aussi a chaud PCL 25/4)
Prensa en frio P 25/4 (disponibile con platos calientes PCL 25/4)
Kaltpresse P 25/4 (auch mit Heizplatten, Ausführung PCL 25/4)

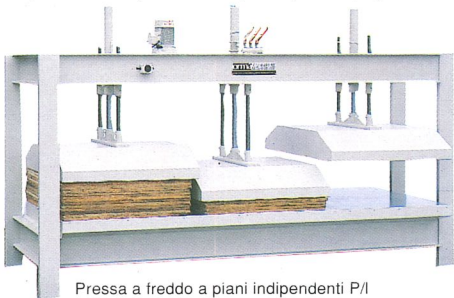

Pressa a freddo a piani indipendenti P/I
P/I cold press with splitted platens.
Presse a froid P/I avec plateaux independants
Prensa en frio con platos independientes P/I
Kaltpresse P/I mit unabhängigen Platten

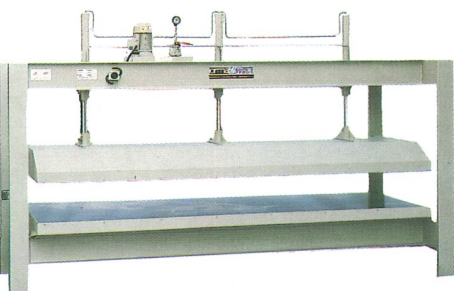

Pressa a freddo P 30/3 (disponibile anche con piani a caldo PCL 30/3)
P 30/3 cold press (hot version too PCL 30/3)
Presse a froid P 30/3 (disponibile aussi a chaud PCL 30/3)
Prensa en frio P 30/3 (disponibile con platos calientes PCL 30/3)
Kaltpresse P 30/3 (auch mit Heizplatten, Ausführung PCL 30/3)

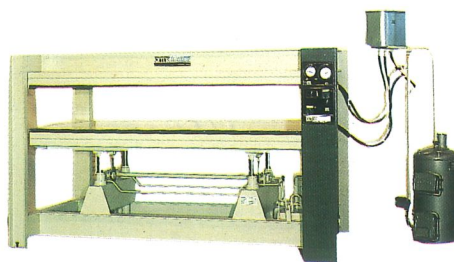

Pressa a caldo C/4 (disponibile anche con piani a freddo S/4)
C/4 hot press (cold version too S/4)
Presse a chaud C/4 (disponibile aussi a froid S/4)
Prensa platos calientes C/4 (disponible con platos frios S/4)
Heizplattenpresse C/4 (auch in kalter Ausführung S/4)

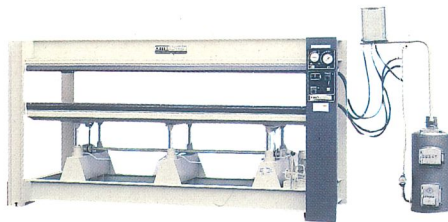

Pressa a caldo C/6 (disponibile anche con piani a freddo S/6)
C/6 hot press (cold version too S/6)
Presse a chaud C/6 (disponibile aussi a froid S/6)
Prensa platos calientes C/6 (disponibile con platos frios S/6)
Heizplattenpresse C/6 (auch in kalter Ausführung S/6)

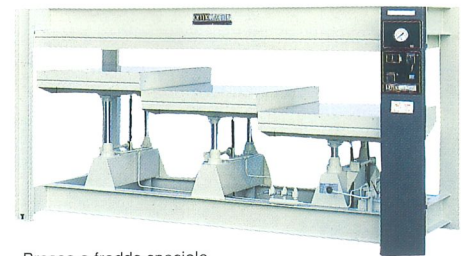

Pressa a freddo speciale
Special cold press
Presse a froid speciale
Prensa en frio especial
Sonderkaltpresse

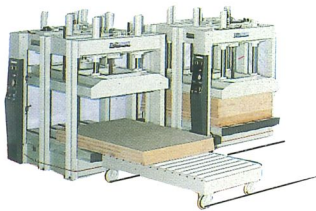

Impianto di pressatura automatico a freddo
Automatic cold pressing system
Ligne de pressage automatique a froid
Instalacion de prensado en frio
Automatische Kaltpreßanlage

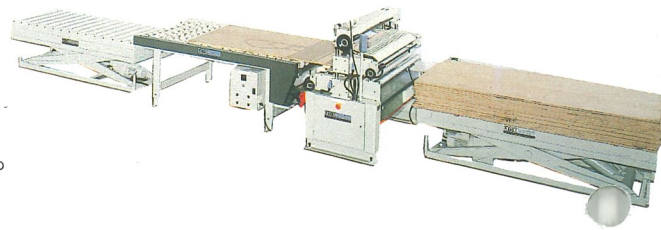

PRESSE A CALDO

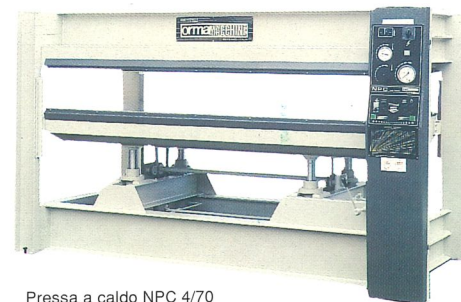

Pressa a caldo NPC 4/70
NPC 4/70 hot press
Presse a chaud NPC 4/70
Prensa platos calientes NPC 4/70
Heizplattenpresse NPC 4/70

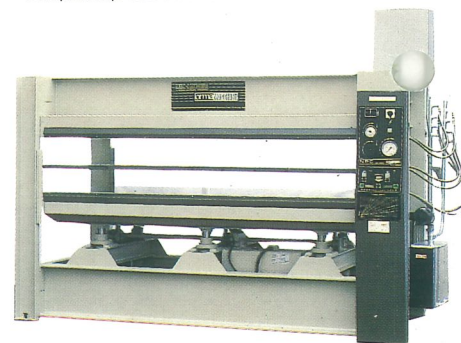

Pressa a caldo NPC 6/90
NPC 6/90 hot press
Presse a chaud NPC 6/90
Prensa platos calientes NPC 6/90
Heizplattenpresse NPC 6/90



Pressa a caldo NPC 6/110
NPC 6/110 hot press
Presse a chaud NPC 6/110
Prensa platos calientes NPC 6/110
Heizplattenpresse NPC 6/110



Pressa a freddo PFH
PFH heavy cold press
Presse a froid PFH
Prensa en frio PFH
Kaltpresse PFH

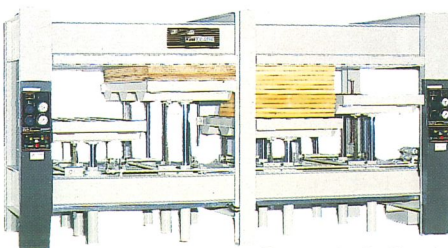

Pressa a freddo HL
Heavy cold press HL
Presse a froid HL
Prensa en frio HL
Kaltpresse HL

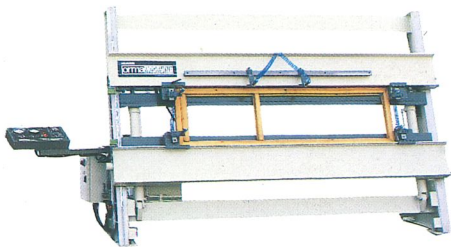

Strettoio SU/FUTURA
Frame press SU/FUTURA
Cadreuse SU/FUTURA
Banco de armar con travesia unica SU/FUTURA
Rahmenpresse SU/FUTURA

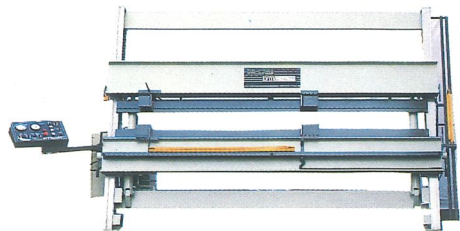

Strettoio SU/FUTURA a ricerca automatica
Frame press SU/FUTURA with automatic positioning
Cadreuse SU/FUTURA a recherche automatique
Banco de armar con busqueda automatica de la madera SU/FUTURA
Rahmenpresse SU/FUTURA mit automatischer Positionierung

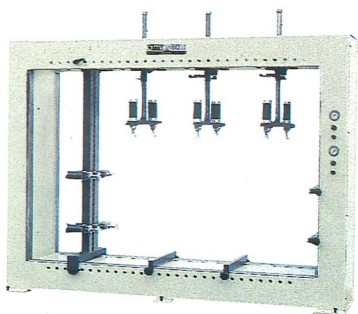

Strettoio per corpi di mobili SMF 26/16
Carcass cramp type SMF 26/16
Volucadreuse type SMF 26/16
Prensa neumatica para cuerpos de muebles SMF 26/16
Korpuspresse SMF 26/16

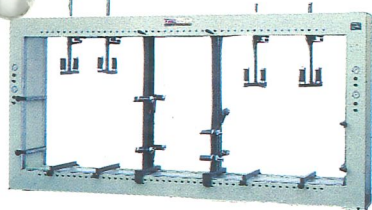

Strettoio per corpi di mobili a due stazioni di lavoro SMF 51/28
Two working stations carcass cramp type SMF 51/28
Volucadreuse a deux place de travail SMF 51/28
Prensa neumatica para cuerpos de muebles con 2 puestos de trabajo SMF 51/28
Korpuspresse SMF 51/28 mit 2 Arbeitsräumen

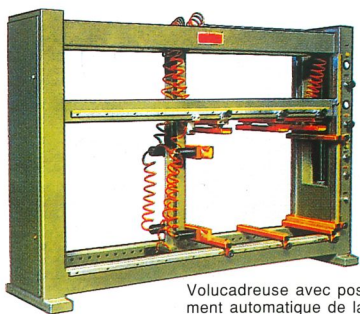

Strettoio per corpi di mobili con posizionamento automatico della trave tipo SMF/AUTOMATICO
Carcass cramp with automatic positioning of the horizontal beam type SMF/AUTOMATICO

Volucadreuse avec positionnement automatique de la poutre hor. SMF/AUTOMATICO
Prensa neumatica con posicionamiento automatico de la travesia SMF/AUTOMATICO
Korpuspresse SMF/AUTOMATICO mit automatischer Positionierung des Trägers

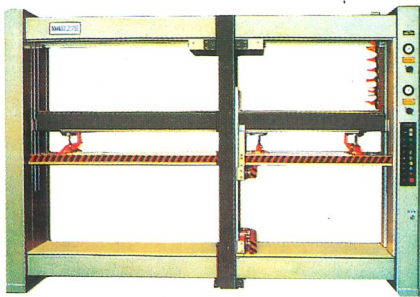

Strettoio per corpi di mobili autocontrante tipo SMF/SUPER
Self setting carcass cramp type SMF/SUPER
Volucadreuse automatique type SMF/SUPER
Prensa neumatica para cuerpos de muebles con auto-centrado SMF/SUPER
Selbstzentrierende Korpuspresse SMF/SUPER

MACCHINE LAVORAZIONE LEGNO WOODWORKING MACHINERY MACHINES A TRAVAILLER LE BOIS

ORMA MACCHINE

24020 TORRE BOLDONE (BG) ITALY

V.LE LOMBARDIA,47 Tel.035 340300

Tlx 305485 ORMA I-Fax 035 346290

PRESSE PER POLIURETANO



Presse per la lavorazione del poliuretano tipo PXE
Presses for poliurethane type PXE
Presses pour poliurethane type PXE
Prensa para el poliuretano tipo PXE
Presse Typ PXE zur Bearbeitung von Polyurethan

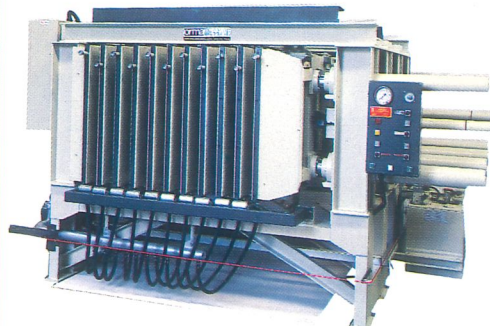

Presse per la lavorazione del poliuretano tipo PXE
Presses for poliurethane type PXE
Presses pour poliurethane type PXE
Prensa para el poliuretano tipo PXE
Presse Typ PXE zur Bearbeitung von Polyurethan

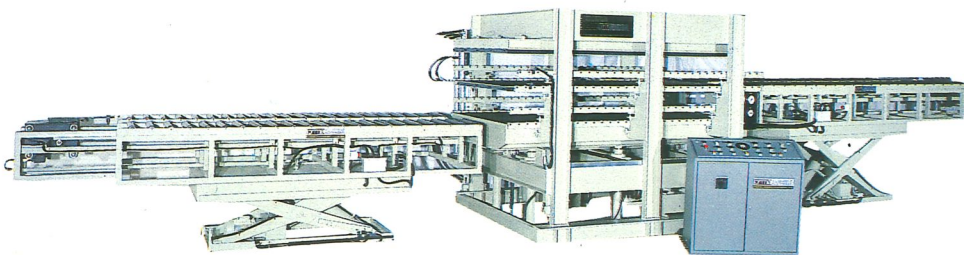

Impianto con carico e scarico automatico per la lavorazione del poliuretano
Complete plant for poliurethane, automatic feeding and outfeeding
Ligne en continu pour le poliurethane
Linea con carga y descarga automatica especial para el poliuretano
Anlage zur Bearbeitung von Polyurethan mit automatischer Beschickung und Entladung

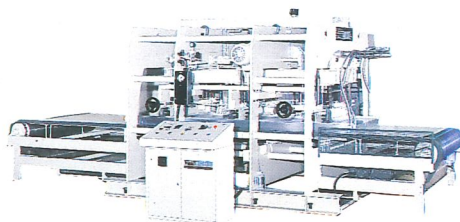

Presse per la lavorazione del poliuretano tipo PXE
Presses for poliurethane type PXE
Presses pour poliurethane type PXE
Prensa para el poliuretano tipo PXE
Presse Typ PXE zur Bearbeitung von Polyurethan



Presse per la lavorazione del poliuretano tipo PXE
Presses for poliurethane type PXE
Presses pour poliurethane type PXE
Prensa para el poliuretano tipo PXE
Presse Typ PXE zur Bearbeitung von Polyurethan

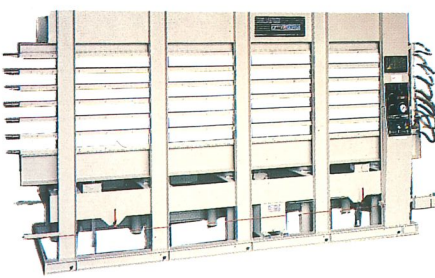

Presse per la lavorazione del poliuretano tipo PXE
Presses for poliurethane type PXE
Presses pour poliurethane type PXE
Prensa espcia para el poliuretano tipo PXE
Presse Typ PXE zur Bearbeitung von Polyurethan

LINEE DI PRESSATURA

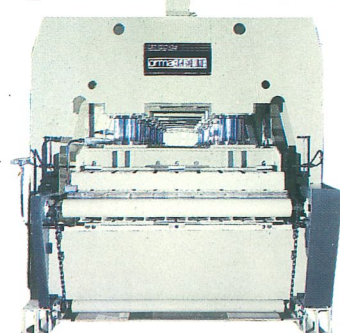

Linea di pressatura in ciclo continuo
Through feed press (end loading)
Ligne a plaquer en continu
Linea de prensado en ciclo continuo
Durchlaufpreßanlage

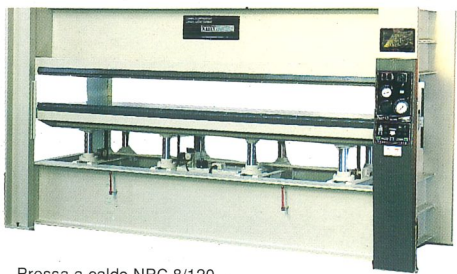

Pressa a caldo NPC 8/120
NPC 8/120 hot press
Presse a chaud NPC 8/120
Prensa platos calientes NPC 8/120
Heizplattenpresse NPC 8/120

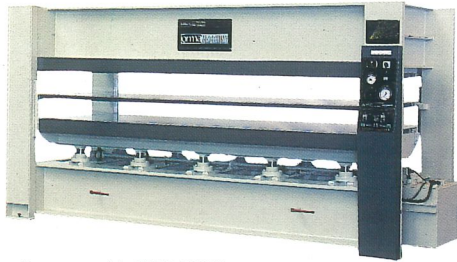

Pressa a caldo NPC 10/200
NPC 10/200 hot press
Presse a chaud NPC 10/200
Prensa platos calientes NPC 10/200
Heizplattenpresse NPC 10/200



Automatizzazione di una NPC (NPC/A)
Light through feed press NPC/A
Automatisation d'une presse NPC (NPC/A)
Automatizaci3n de una NPC (NPC/A)
Automatisierung einer Presse NPC (NPC/A)

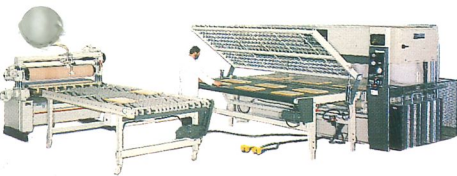

Pressa a caldo NPC/RF con carico e scarico sullo stesso lato
Light through feed press NPC/RF (side feeding and outfeeding)
Presse a chaud NPC/RF avec chargement et dechargement de la m4me cote
Prensa platos calientes con carga y descarga del mismo lado
NPC/RF
Heizplattenpresse NPC/RF mit Beschickung und Entladung an gleicher Seite



Pressa a caldo NPC/L per l'incollaggio dei listelli
Edge-joining press NPC/L
Presse a panneauter NPC/L
Prensa platos calientes NPC/L para el encolado de listones
Heizplattenpresse NPC/L zur Verleimung von Leistenplatten

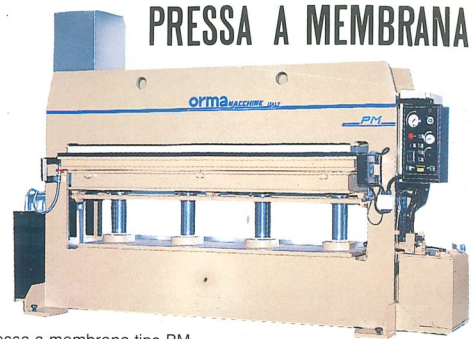
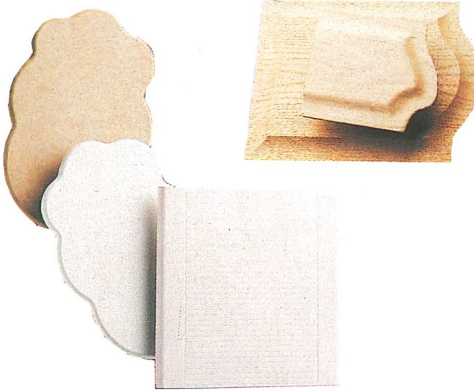

Pressa a membrana tipo PM
Membrane press PM
Presse a membrane PM
Prensa a membrana tipo PM
Membran-Formenpresse Typ PM

PRESSE PER STAMPARE

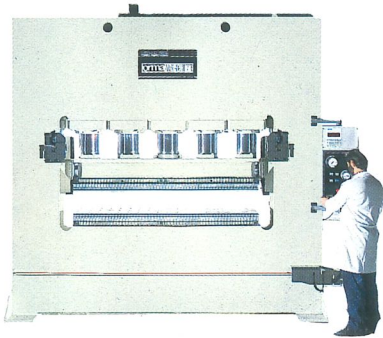

Pressa per stampra PSA
Embossing press PSA
Presse a estamper PSA
Prensa para estampar la madera PSA/S
Presse zum Pr4gen PSA

Pressa per stampra PSA/S
Embossing press PSA/S
Presse a estamper PSA/S
Prensa para estampar la madera PSA/S
Presse zum Pr4gen PSA/S



PRESSA PER LISTELLI

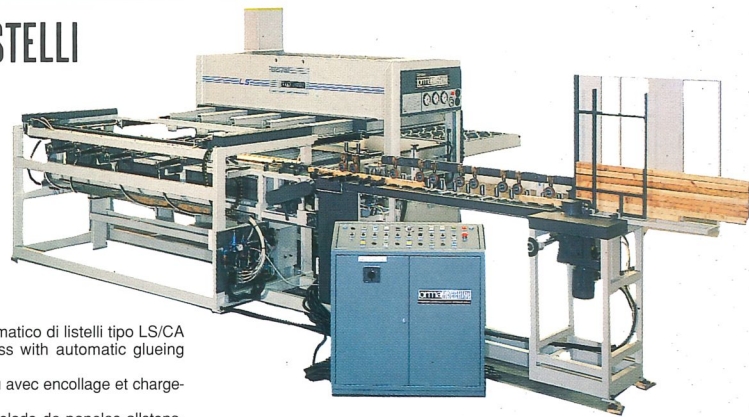
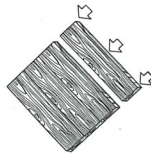

Pressa per l'incollaggio in automatico di listelli tipo LS/CA
Edge joining through feed press with automatic glueing and feeding LS/CA
Ligne de premontage en continu avec encollage et chargement aut. tipe LS/CA
Prensa para la formacion y encolado de paneles allstonados LS/CA
Presse zur Leistenplatten-Herstellung Typ LS/CA

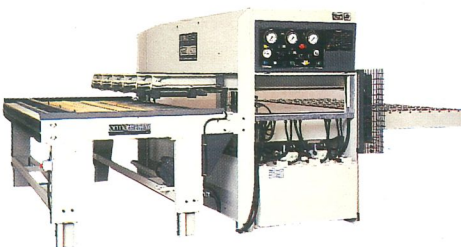

Pressa per l'incollaggio in automatico di listelli tipo LS
Edge joining through feed press LS type
Ligne de panneautage en continu type LS
Prensa para la formacion de paneles alistonados tipo LS
Presse zur Leistenplatten-Herstellung Typ LS

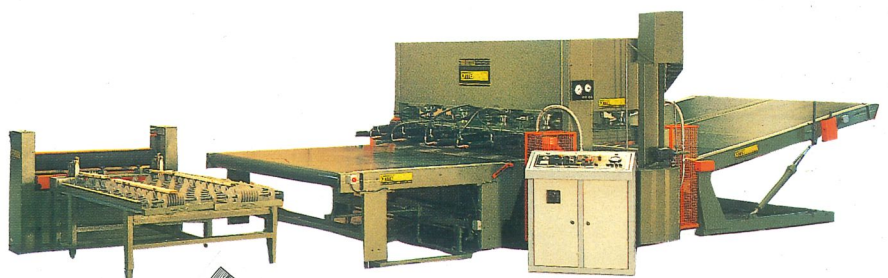

Pressa per l'incollaggio di listelli in automatico tipo PCS
Edge-joining and veneering through-feed press PCS
Ligne de panneautage et piacage en continu type PCS
Prensa para la formacion de paneles alistonados en automatico PCS
Presse zur Leistenplatten-Herstellung Typ PCS

MACCHINE LAVORAZIONE LEGNO
WOODWORKING MACHINERY
MACHINES A TRAVAILLER LE BOIS

ormaMACCHINE

24020 TORRE BOLDONE (BG) ITALY
V.LE LOMBARDIA,47 Tel.035 340300
Tlx 305485 ORMA I-Fax 035 346290



Impianto per la produzione di pannelli listellari con sistema di taglio
 Edge-joining through feed line with side and end cutting after the press
 Ligne de panneutage en continu avec tronçonnage
 Línea para la formación de paneles alistonados con corte automático
 Anlage zur Leistenplatten-Herstellung mit Schneidemaschine

STRETTOI PER SERRAMENTI

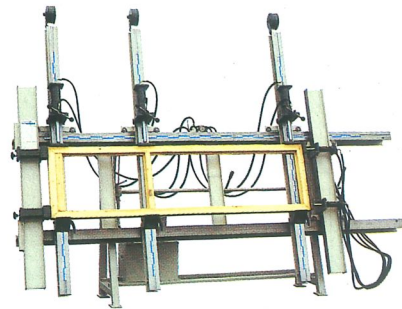

Strettoio tipo DE
 Frame press type DE
 Cadreuse type DE
 Banco de armar tipo DE
 Rahmenpresse Typ DE

PRESSE PER CURVARE

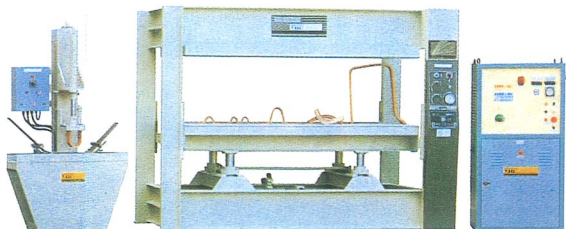

Impianto completo per la curvatura del legno massiccio
 Solid wood bending plant
 Ligne de cintrage du bois massif
 Instalacion completa para curvar la madera maciza
 Komplette Anlage zum Biegen von Massivholz

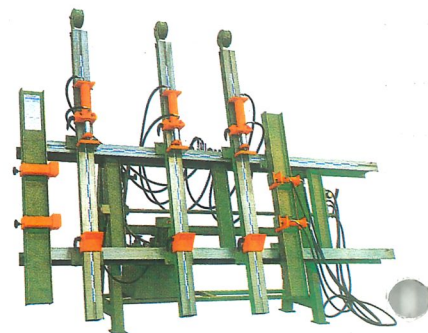

Strettoio pesante tipo SP
 Heavy frame press type SP
 Cadreuse type SP
 Banco de armar pesante tipo SP
 Rahmenpresse Typ SP

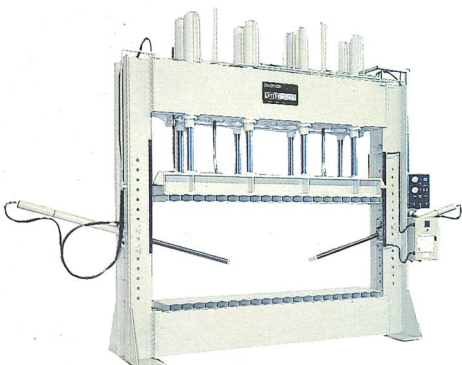

Pressa per curvare il legno tipo PFS
 Bending press type PFS
 Presse a cintrer type PFS
 Prensa para curvar la madera PFS
 Presse zum Biegen PFS

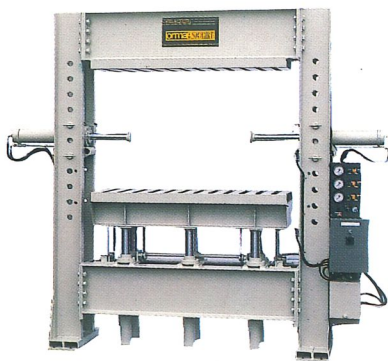

Pressa per curvare il legno tipo PFS
 Bending press type PFS
 Presse a cintrer type PFS
 Prensa para curvar la madera PFS
 Presse zum Biegen PFS



Strettoio a barra unica tipo SU/15
 Frame press type SU/15 with one horizontal pressing beam
 Cadreuse a poutre type SU/15
 Banco de armar con traviesa unica tipo SU/15
 Rahmenpresse mit einem waagrechten Träger Typ SU/15

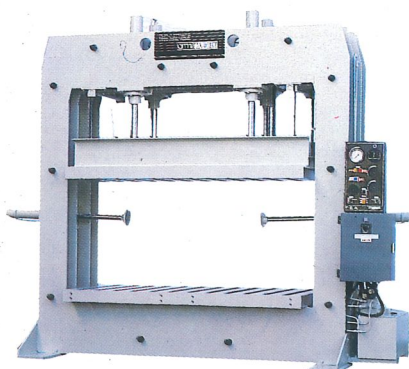

Pressa per curvare il legno tipo PFS
 Bending press type PFS
 Presse a cintrer type PFS
 Prensa para curvar la madera PFS
 Presse zum Biegen PFS



Pressa per curvare il legno tipo PFS
 Bending press type PFS
 Presse a cintrer type PFS
 Prensa para curvar la madera PFS
 Presse zum Biegen PFS

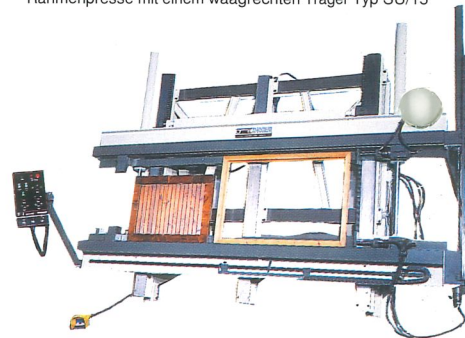

Strettoio SU/15 con centratura elettronica
 Frame press SU/15 with electronic positioning
 Cadreuse SU/15 avec centrage électronique
 Banco de armar SU/15 con centrado electrónico
 Rahmenpresse SU/15 mit automatischer Zentrierung

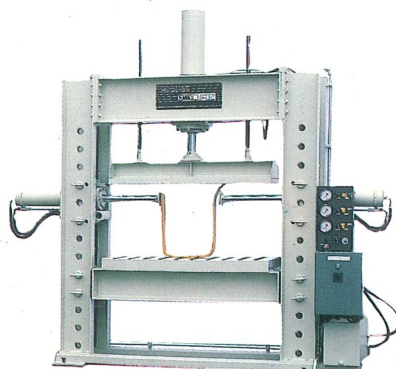

Pressa per curvare il legno tipo PFS
 Bending press type PFS
 Presse a cintrer type PFS
 Prensa para curvar la madera PFS
 Presse zum Biegen PFS

MACCHINE LAVORAZIONE LEGNO
 WOODWORKING MACHINERY
 MACHINES A TRAVAILLER LE BOIS
ormamACCHINE

24020 TORRE BOLDONE (BG) ITALY
 V.LE LOMBARDIA,47 Tel.035 340300
 Tlx 305485 ORMA I-Fax 035 346290

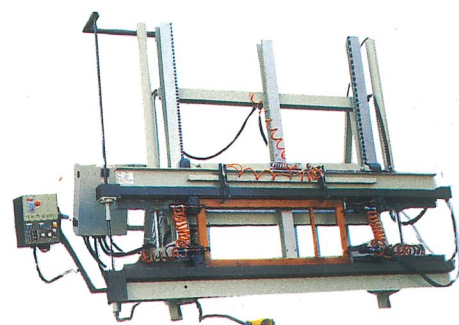

Strettoio SU/15 cnc a controllo numerico
 Cnc frame press SU/15
 Cadreuse SU/15 a control numerique
 Banco de armar SU/15 a control numerico
 Rahmenpresse SU/15 mit CNC-Steuerung

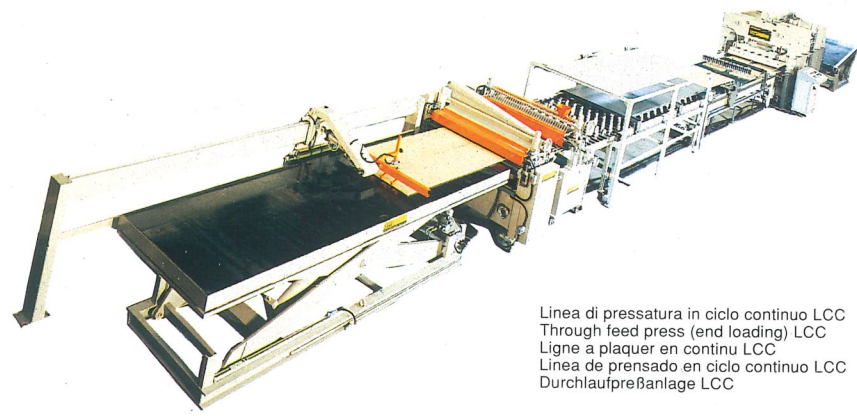

Linea di pressatura in ciclo continuo LCC
Through feed press (end loading) LCC
Ligne a plaquer en continu LCC
Linea de prensado en ciclo continuo LCC
Durchlaufpreßanlage LCC

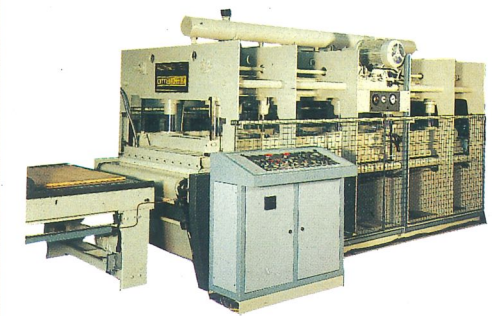

Linea di pressatura in ciclo continuo LCC
Through feed press (end loading) LCC
Ligne a plaquer en continu LCC
Linea de prensado en ciclo continuo LCC
Durchlaufpreßanlage LCC

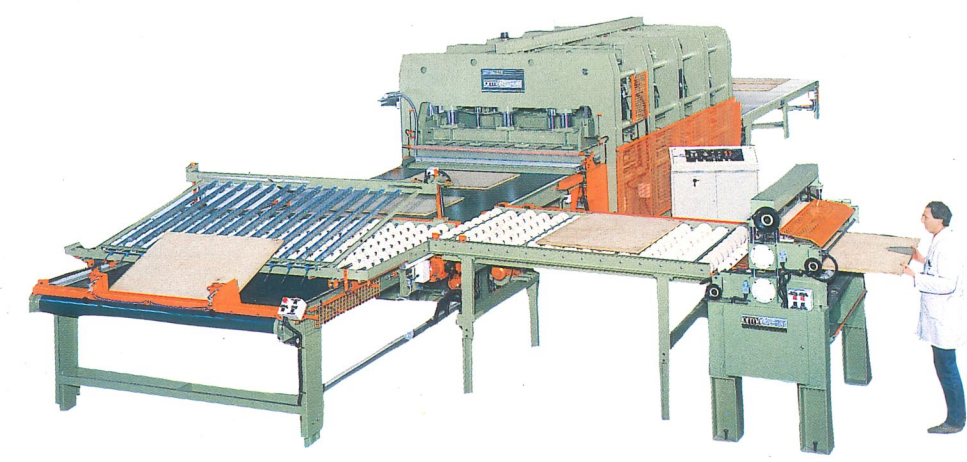

Linea di pressatura in ciclo continuo LCC
Through feed press (end loading) LCC
Ligne a plaquer en continu LCC
Linea de prensado en ciclo continuo LCC
Durchlaufpreßanlage LCC



Incollatrice a 2 rulli tipo I/213
2 roller glue spreader
Encolleuse a 2 rouleaux
Encoladora a 2 rulos tipo I/213
Leimauftragmaschine mit 2 Walzen Typ I/213

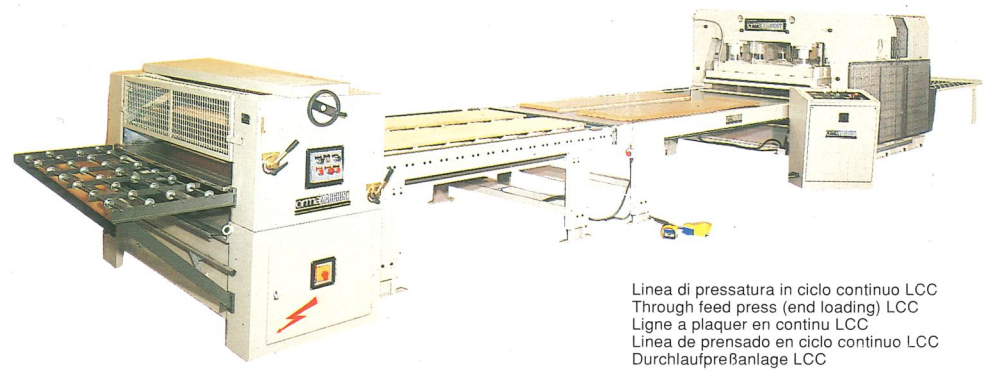

Linea di pressatura in ciclo continuo LCC
Through feed press (end loading) LCC
Ligne a plaquer en continu LCC
Linea de prensado en ciclo continuo LCC
Durchlaufpreßanlage LCC

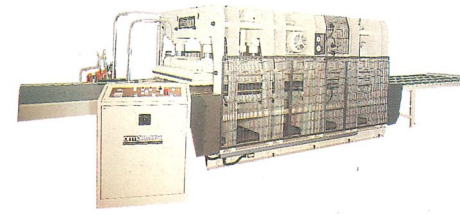

Linea di pressatura in ciclo continuo LCC
Through feed press (end loading) LCC
Ligne a plaquer en continu LCC
Linea de prensado en ciclo continuo LCC
Durchlaufpreßanlage LCC



Incollatrice a 4 rulli
4 roller glue spreader
Encolleuse a quatre rouleaux
Encoladora a 4 rulos
Leimauftragmaschine mit 4 Walzen

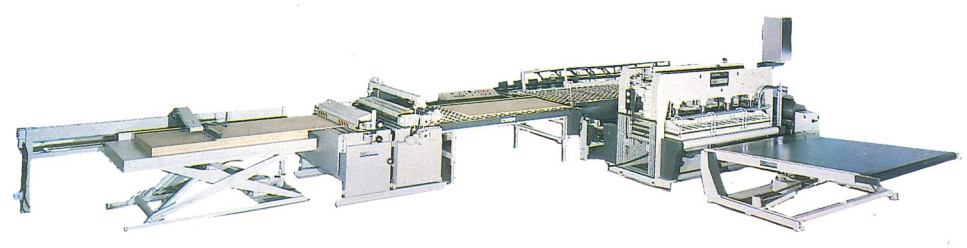

Linea di pressatura in ciclo continuo PCC
Through feed press (side loading) PCC
Ligne a plaquer en continu PCC
Linea de prensado en ciclo continuo PCC
Durchlaufpreßanlage PCC

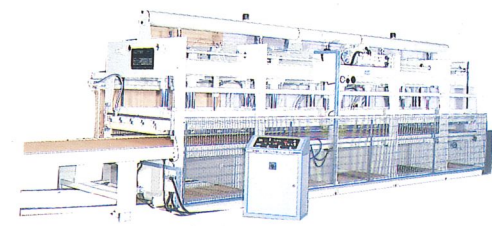

Linea di pressatura in ciclo continuo LCC
Through feed press (end loading) LCC
Ligne a plaquer en continu LCC
Linea de prensado en ciclo continuo LCC
Durchlaufpreßanlage LCC

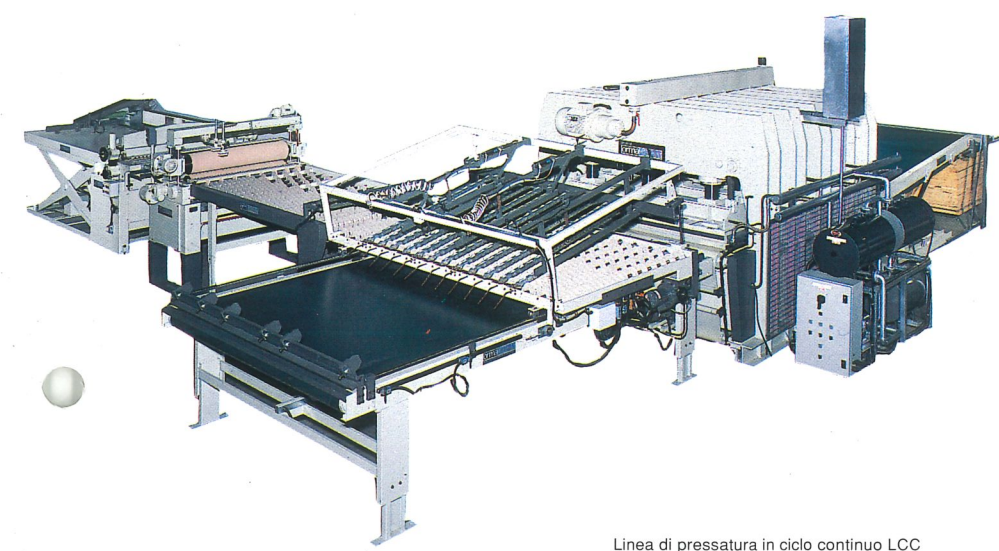

Linea di pressatura in ciclo continuo LCC
Through feed press (end loading) LCC
Ligne a plaquer en continu LCC
Linea de prensado en ciclo continuo LCC
Durchlaufpreßanlage LCC



Spazzolatrice superiore ed inferiore
Top and bottom brushing machine
Brosseuse superieure et inferieure
Acepilladora superior e inferior
Obere und untere Burstenmaschine

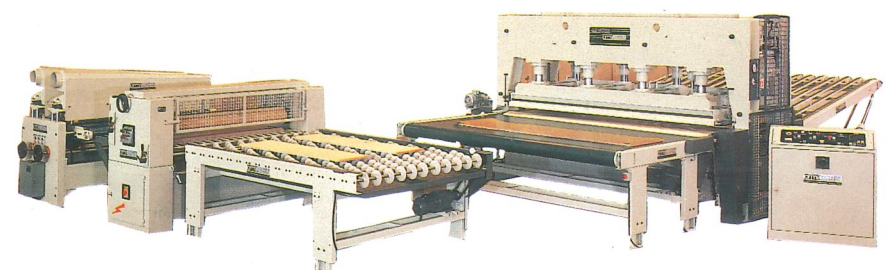

Linea di pressatura in ciclo continuo PCC
Through feed press (side loading) PCC
Ligne a plaquer en continu PCC
Linea de prensado en ciclo continuo PCC
Durchlaufpreßanlage PCC

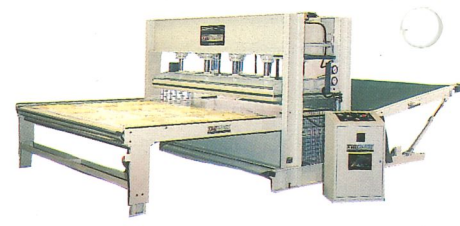

Linea di pressatura in ciclo continuo PCC/L
Through feed press PCC/L (side loading)
Ligne a plaquer en continu PCC/L
Linea de prensado en ciclo continuo PCC/L
Durchlaufpreßanlage PCC/L

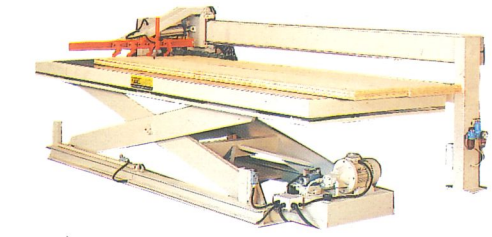

Piattaforma elevatrice con spintore pneumatico
Lifting table complete with pneumatic pusher
Plateforme elevatrice avec pousseur pneumatique
Plataforma elevadora con empujador pneumatico
Hebebühne mit pneumatischem Stößel

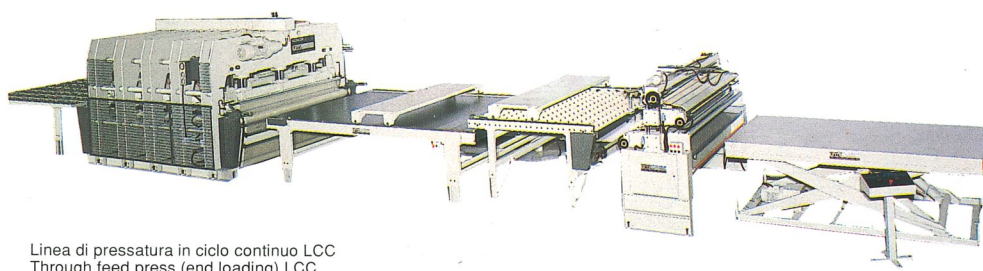

Linea di pressatura in ciclo continuo LCC
Through feed press (end loading) LCC
Ligne a plaquer en continu LCC
Linea de prensado en ciclo continuo LCC
Durchlaufpreßanlage LCC

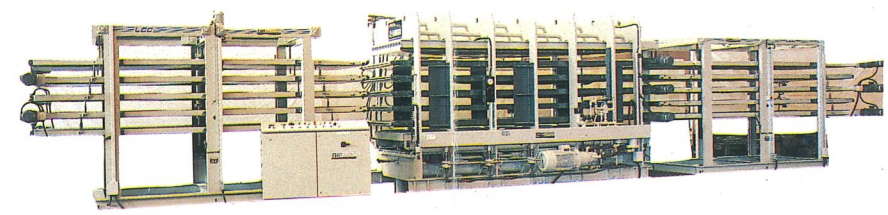

Linea di pressatura in ciclo continuo
Multidaylight through feed press (end loading)
Ligne a plaquer en continu
Linea de prensado en ciclo continuo
Durchlaufpreßanlage

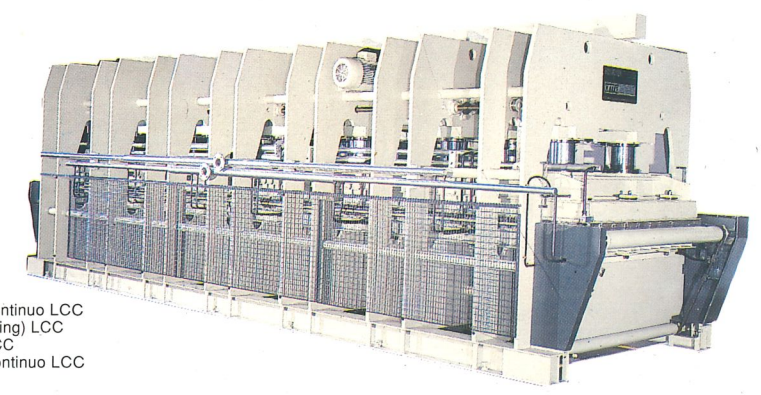

Linea di pressatura in ciclo continuo LCC
Through feed press (end loading) LCC
Ligne a plaquer en continu LCC
Linea de prensado en ciclo continuo LCC
Durchlaufpreßanlage LCC



ormaMAGCHINE

S.R.L.

24020 TORRE BOLDONE (BG) ITALY - V.LE LOMBARDIA, 47

Tel. 035 340300 - Tlx 305485 ORMA I - Fax 035 346290

