

edge banders, sizing edge banders

# stefani md/kd

automatic edge banders for the furniture industry



The logo for Stefani md is a dark blue square with a lighter blue curved shape at the bottom. The text 'stefani' is in a light blue sans-serif font, and 'md' is in a white sans-serif font below it.

stefani  
md

**stefani md**

- speed up to 25 m/min
- machining solid wood up to 22 mm and edges with 3 different radii

The logo for Stefani kd is a dark blue square with a lighter blue curved shape at the bottom. The text 'stefani' is in a light blue sans-serif font, and 'kd' is in a white sans-serif font below it.

stefani  
kd

**stefani kd**

- speed up to 20 m/min
- machining solid wood up to 12 mm and edges with 2 different radii

**stefani md/kd**  
automatic single sided edge banders



# OVERVIEW OF TECHNICAL FEATURES

## TECHNOLOGICAL ADVANTAGES

*Versatile and with high production levels.  
The automatic machining units and the machining speed up to 25 m/min make  
this edge bander perfect for companies that need to continuously produce  
numerous different types of panels.*



### STEFANI MD

Feed speed	m/min	10-22 (25)*
Panel thickness	mm	10-60 (80 opt.)
Edge thickness	mm	0,4 - 15 (22 opt.)
Compressed air	bar	6

\* according to the machine composition

# stefani md/kd

automatic single sided edge banders



# OVERVIEW OF TECHNICAL FEATURES

## TECHNOLOGICAL ADVANTAGES

*Continuous and versatile solutions for quality machining are the distinctive features of stefani kd. All you would expect from an edge banding machine: the use of EVA and Polyurethane glue thanks to the SGP glue pot, machining units with electronic axes allowing the automatic set up for 2 different radii, infinite thin edges and solid wood up to 12 mm. It is the ideal edge bander for all those companies that need to produce many panels for both small and large batch production.*



### STEFANI KD

Feed speed	m/min	20
Panel thickness	mm	8 - 60
Edge thickness	mm	0,4 - 12
Compressed air	bar	6



# OPERATING UNITS

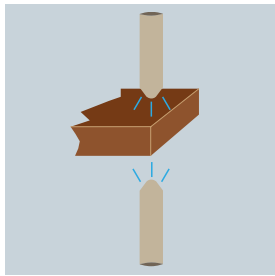

## Anti-adhesive AAR

It prevents the glue residue from adhering to the panels

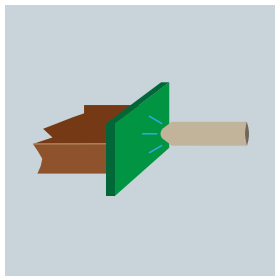

## Nebulizing device for delicate edges

It facilitates machining of panels with delicate edges or with protective films.

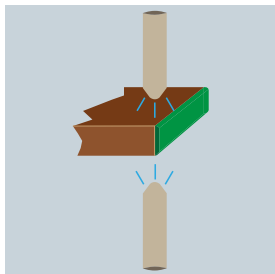

## Nebulizing device for edge finishing

It facilitates the finish of plastic edge brightening the colours along with the brushing unit.

## DEVICES FOR LIQUID FINISHING



## ENERGY ONLY WHEN NEEDED

**SavEnergy** allows the operation of the devices only when really necessary. The machine automatically enters stand-by mode when there are no panels to be machined.



**PRE-MILLING UNIT: PERFECT JOINT LINE**

An optimal edge gluing surface is achieved with large diameter tools (100 mm) and absence of vibrations during the machining thanks to the sturdy structure.

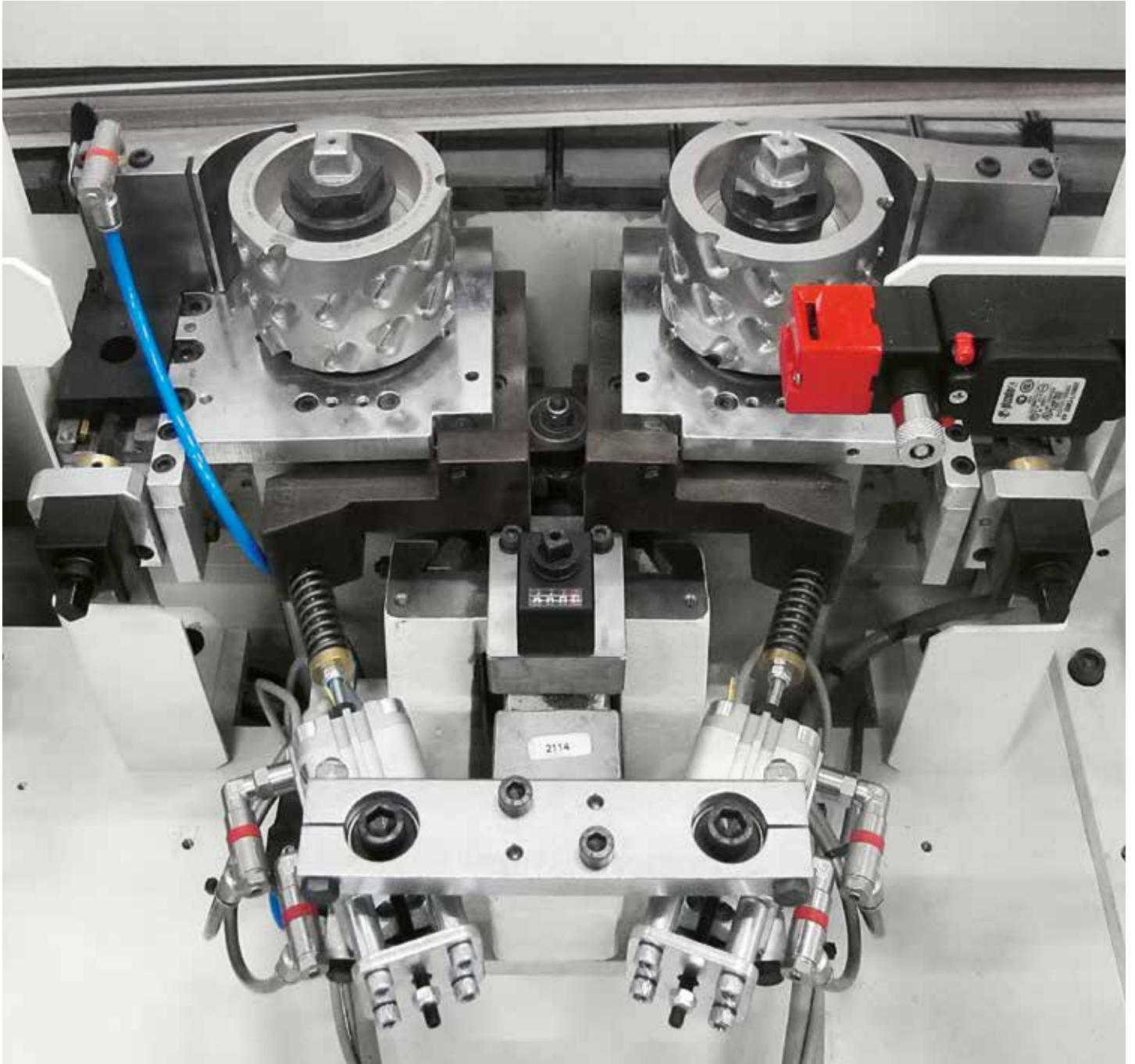

# OPERATING UNITS



## GLUING UNIT: PERFECT EDGE APPLICATION

Optimal edge gluing requires highly developed applications such as PU BOX L and AirFusion+ devices that ensure high level finishing.



## PU BOX L: GLUE ONLY WHEN NEEDED, NO WASTE

Integrated premelting device to melt polyurethane glues in 2 Kg cartridges. High versatility thanks to flexible changeover with EVA glue.

## ALTAPUR 4HO PREMELTER

For premelting up to 6 Kg/h of PU glue in cartridge. Available for the filling of the EB 60 V glue slot applicator (opt).



# AirFusion<sup>+</sup>

by **scm**

AirFusion<sup>+</sup> provides a surprising level of finishing quality. This technology, edgebanding without glue, ensures the joint between the edge and the panel is invisible. Pressurised air at a high temperature is conveyed on a specific edge so that a layer of the material fuses with the panel, therefore ensuring glue is unnecessary. The extremely versatile AirFusion<sup>+</sup> technology is compatible and can be perfectly integrated with traditional gluing technologies. It is also available on the whole range of the SCM edgebanders. AirFusion<sup>+</sup>, with speeds up to 25 metres per minute, can be configured to achieve different levels of performance.

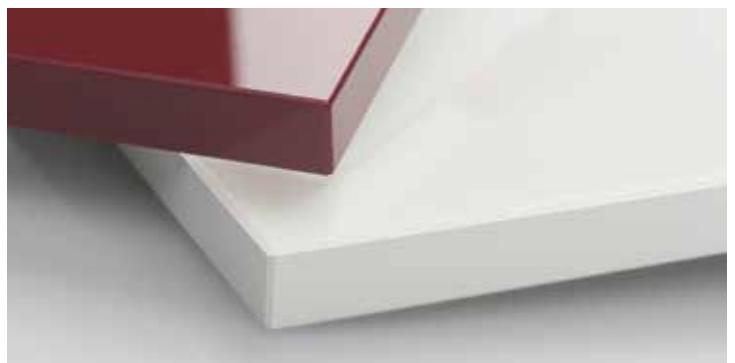

*\*Copyright REHAU AG +CO*



## **SGP GLUE POT: IDEAL GLUE LINE**

Obtained thanks to the precise glue dosage adjustment and the spreading roller with a special knurling and variable pitch. The use of EVA and Polyurethane glue is made possible by the anti-adherent plasma treatment of the glue pot and a fast and simple glue changeover.

# OPERATING UNITS

## END TRIMMING UNIT: PERFECT FINISH EVERY TIME

The optimal cut for excess edge is always guaranteed by a precise and reliable kinematics in all working conditions.

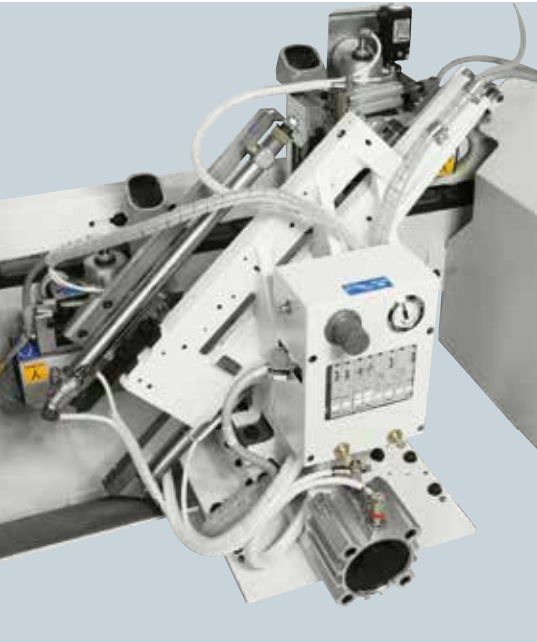

**K/SEL**

md

kd

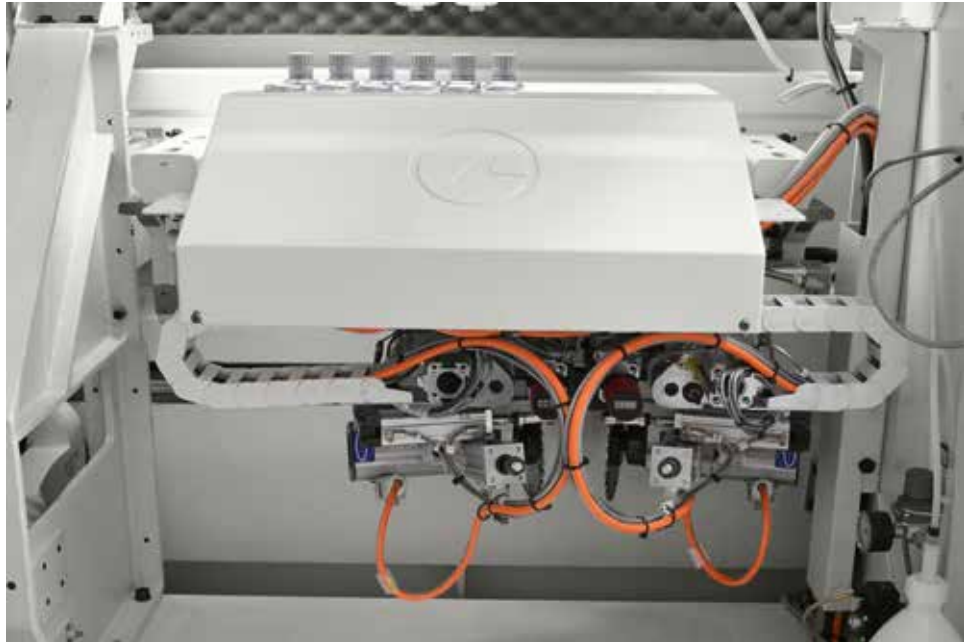

**YU/SP-750**

md

## TRIMMING UNIT: EDGE ROUGHING AND FINISHING

Trimming of solid wood edges or removal of excess edge material to facilitate the subsequent corner rounding process.

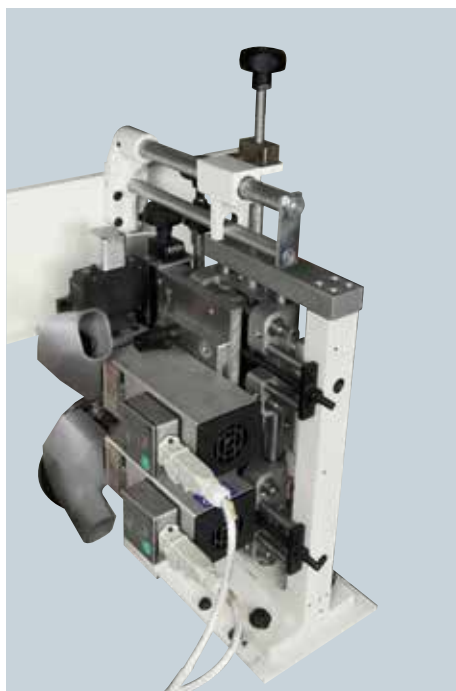

**RSP**

md



**RS/K**

kd

**CHAMFERING UNIT: FINISHING AND VERSATILITY**

Excellent edge finish due to the vibration-free solid structure. Low machining changeover times with customisable automation packages.

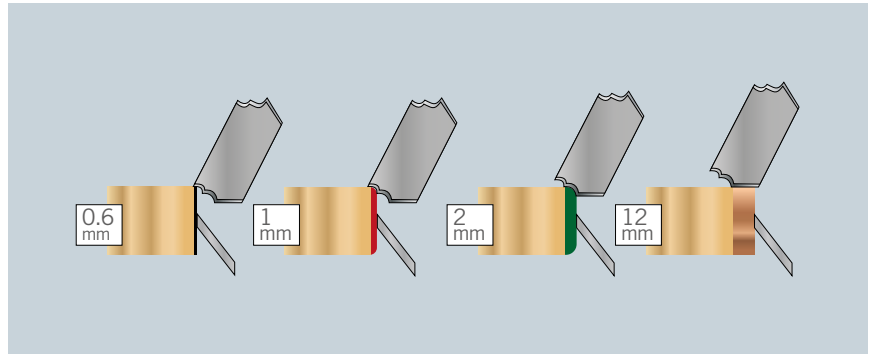

**R-HP MULTIEDGE**

**Trimming/chamfering unit**

Processing with automatic set up of 2 different radii, infinite thin edges and solid wood up to 12 mm.

kd

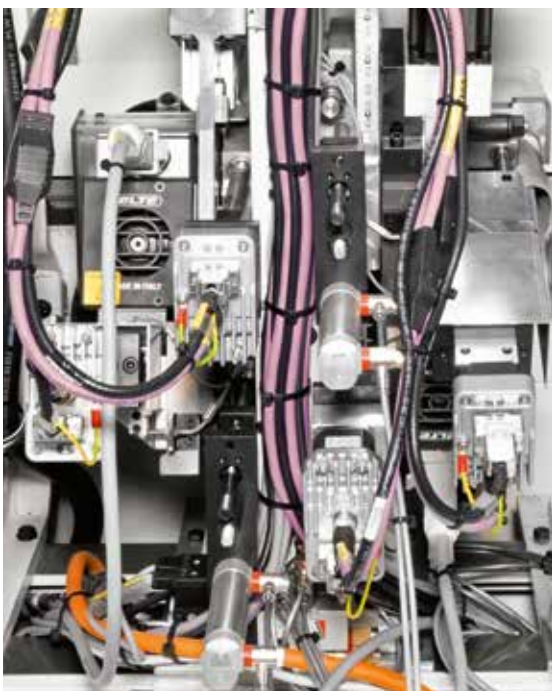

**R/S**

Possibility to process with 3 different radii and infinite thin edges (Multiedge version) or solid wood up to 15 mm.

md



# OPERATING UNITS

## 2-MOTOR CORNER ROUNDING UNIT

Excellent finish quality and different production levels are possible with a complete range of solutions for panel corner rounding and trimming.



### ROUND SK – 18 m/min

Complete panel machining with the double corner rounding and trimming functions.

md

kd



### ROUND SK MULTIEDGE DEVICE

Automatic adjustment for the processing of rounded and thin edges.

#### 4-MOTOR CORNER ROUNDING UNIT

High performance and versatile with the 4-motor design that allows the machining of the wooden edges.



#### ROUND 4M – 22 m/min

Corner rounding and trimming with wooden edges and with panels with different profiles and radiuses.

md



**KIT "3 EDGE"**: automatic set up for machining 2 radii + 1 thin edge.

# OPERATING UNITS

## EDGE SCRAPER UNIT: PERFECT FINISH ON PLASTIC EDGES

Excellent finish on plastic edges by smoothing previously trimmed edges.

## RAS 1000

Fast and simple change of the machining radius by replacing the tool holder head complete with rotating track feelers.



md kd



## RAS-HP MULTIEDGE

Processing of two different radii with pneumatic or NC positioning.

kd

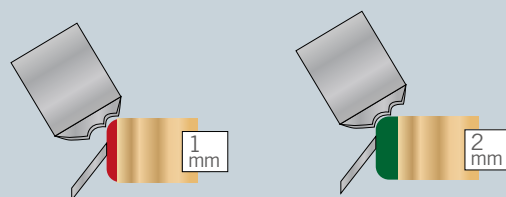





**RAS/S 2P**

Automatic change of the machining radius with the double pneumatic tool position.

md

**AUTOMATION PACKAGES**



Edge scraper  
2 radii



Edge scraper  
3 radii

**NESTING COPYING DEVICES**



md

kd

# OPERATING UNITS

**SPINDLE GROOVING UNIT:** Through or timed grooves on the upper (U only), lower and front sides of the panel



## K-100

Unit with front feelers-60 mm<sup>2</sup> max groove section

kd

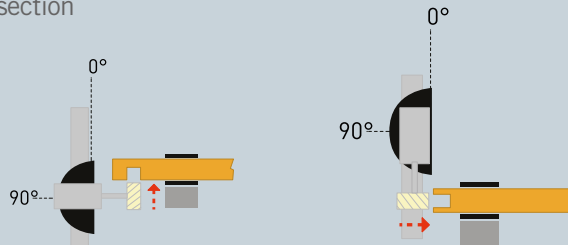

## U

Unit with vertical and front feelers-120 mm<sup>2</sup> max groove section

md

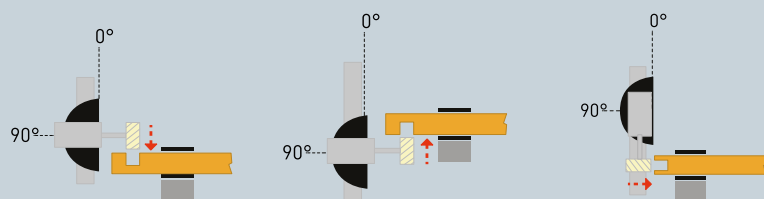

## SANDING UNIT GLC

For finishing and preparation of veneered and solid wood edges for painting.

md



## GLUE SCRAPER UNIT RCA/2C

It removes any excess glue in the edge/panel joints. Optimal 2-bearing copying.



**BRUSHING UNIT SPN**

To clean the panels and brighten plastic edges with fast adjustment of working pressure and tilting.

**EDGE BRIGHTENING UNIT ID3000**

To finish plastic edges.



**BELT PRESSER**

Ideal for panels with delicate surfaces.



**AIR CUSHION TABLE**

For an easy introduction of the panel into the machine.

# PANEL RETURN DEVICE



	LENGTHWISE FEEDING		CROSSWISE FEEDING		Panel thickness	Maximum panel weight (Kg)
	Minimum length	Maximum length	Minimum length	Maximum length		
Fastback 21	250	2100	120	800	8 - 60	40
Fastback 25	250	2500	120	1200	8 -60	50



*Productivity increased up to 30% - 40% with a single operator thanks to the **Fastback** device for automatic panel return to the operator.*

#### **MAXIMUM FREEDOM:**

with the **Buffer Kit** (opt) the non-collection of the temporary panel does not block the operation of the edgebander.

#### **OUT-OF-SIZE WITHOUT PROBLEMS:**

with the **Extra Size Kit** (opt) the production also of the oversize is however possible in a simple and assisted way.

#### **THINK BIG:**

with the **Re-Loop Kit** (opt) it is possible to set up one complete cell where the operator can manage the machining of the various panel sides easily and ergonomically.



# M Maestro Digital Systems

SMART SOFTWARE AND DIGITAL SERVICES TO ENHANCE PRODUCTIVITY OF WOODWORKING AND FURNITURE INDUSTRIES.

> programming and data generation

Maestro office

Office

Factory

Maestro active

> edge banding

## SOFTWARE

### Simple, smart and open.

Maestro software are tailored on the machine technology as well as on the entire process. All Maestro software share a common mission:

**easy to use**, so that any operator can easily and confidently learn and use the software

**smart**, with algorithms and computing modules aiming at the best possible result

**open** in order to integrate existing software, and provide customer the coverage of all his process.

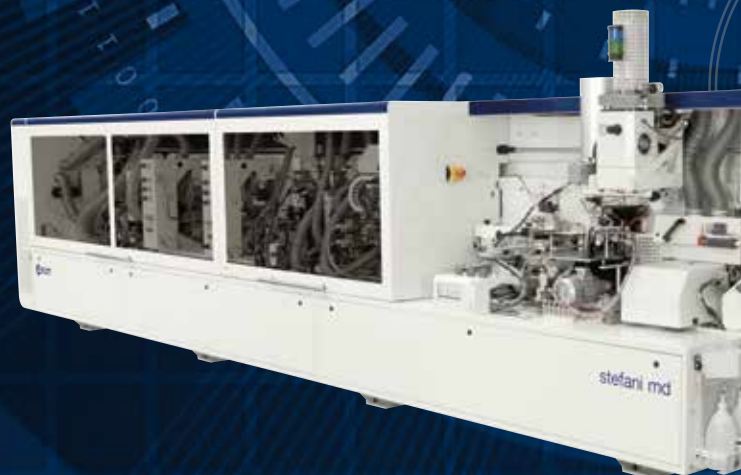

SCM accompanies woodworking companies throughout their whole process combining machines with matching software solutions and digital services, with a constant strive to enhance company productivity.

The software solutions powered by SCM are developed to optimize machine usage as well as the entire process, providing integration with the different software existing in the company.

## DIGITAL SERVICES

Transforming the way it delivers services to its customers through digital technologies and particularly, the IoT platform that collects and analyses data coming from the machine, **SCM created a world of services enabled by Maestro connect.**

Meaning that connecting an SCM machine through Maestro connect will let customer subscribe a program of fast-evolving services and access a wide range of benefits that even go beyond the machine experience and will support and assist you through the whole life-cycle of your machine.

### Maestro connect IoT Platform

1  
Machine monitoring,  
KPIs, early warning

2  
Maintenance  
equipment

3  
Predictive  
maintenance

4  
Report and historical  
data export to MES

5  
Warranty  
extension

6  
Augmented  
remote support

7  
Smart learning,  
SELF-HEALING,  
video tutorials

8  
Asset management  
with e-shop SCM  
Spare Parts





# Maestro edge



Before the production, it is possible to program and generate edge banding programs directly from the office.

## SOFTWARE

Office

## Maestro edge

# PROGRAMMING THE EDGE BANDER DIRECTLY FROM THE OFFICE

### FUNCTIONS

- Display of all the information present in Maestro active edge
- Receipt of machine production reports generated by the Maestro active edge
- Remote programming with creation of new edges and tools

With the same interface of Maestro active edge, the office software Maestro edge allows tu:

- edit machine programs directly from the office
- recall, view and modify existing programs in the machine



## Maestro active edge

Maestro active is the new operator interface software which has been unified across all SCM technologies. A single operator can easily and confidently run multiple machines due to controller and interface consistency: regardless the machine, Maestro active maintains the same look&feel, with many identical icons and navigation buttons, thus ensuring the same approach to interaction.

### EASE OF USE

The new interface has been specifically designed and optimized for immediate use via touch screen. Graphics have been redesigned for simple and comfortable navigation, with tablet-like icons on touch screen controller.

### “ZERO” ERRORS

Improved productivity thanks to integrated help and recovery procedures that reduce the possibility of error from the operator's side.

## SOFTWARE

## Factory

## Maestro active edge

# A REVOLUTIONARY APPROACH TO INTERACT WITH YOUR SCM MACHINE

### FULL CONTROL OF PRODUCTION PERFORMANCES

The creation of customizable reports by operator, shift, program, forecast period (and much more) allows to monitor, optimize and improve the production performance.

### FULL MACHINE AWARENESS AND KNOWLEDGE MANAGEMENT SYSTEM

Maestro active allows to record the times related to setup, maintenance, training and other events, tracing all the activities in a database. The operator's know-how is also stored and made available to other people inside the organization thanks to the possibility to comment and document all production events or notifications.

### ORGANIZE YOUR PRODUCTION

Maestro active allows to create different users with different roles and authorizations (e.g.: operator, maintainer, administrator, ...). Any user can only execute the functions whose permissions have been assigned to him. It is also possible to define the work shifts on the machine and then detect activities, productivity and events that occurred in each shift.

# A WORLD OF SERVICES FOR GREATER EFFICIENCY

## Maestro connect

### CONNECT YOUR MACHINE AND GAIN ACCESS TO A WORLD OF SERVICES

Connecting your machine through IoT technology, Maestro Connect will let you subscribe a program of fast-evolving services. You will access a wide range of benefits that even go beyond the machine experience and will support and assist you through the whole life-cycle of your machine.

### FASTER SERVICE INTERVENTION AND PROBLEM RESOLUTION

Maestro Connect provides real time data and Health Records of the Machine also to SCM Service drastically reducing its troubleshooting time.

### WORKING ALWAYS IN PERFECT CONDITIONS

Maestro Connect can provide a full kit of sophisticated sensor devices to detect and warn the operator in case of alarming conditions of the machine.

## DIGITAL SERVICES

### SMART MAINTENANCE: DOWN TIME REDUCTION

Maestro Connect reduces maintenance downtime thanks to:

- Automatic maintenance notifications and scheduling, to prevent failures and work in the best conditions of use
- Direct connection to SCM Service thanks to an automatic ticket opening function

### SMART MACHINE: ANYTIME, ANYWHERE AWARENESS

Connecting your SCM machine also means having your machine always at hand.

Immediate instant notifications in case of alarms or downtimes allow customers to immediately take an action thus optimizing his productivity.

### SMART MANAGEMENT: PRODUCTION PERFORMANCE OPTIMIZATION

Reports and KPIs allow further analysis thus increasing Customer Knowledge about his performance and results.

### SMART PARTS: FAST PARTS REPLENISHMENT

MRepairs are scheduled proactively since the system provides Spare Parts suggestions and a direct Integration with Smart Parts e-shop.

### SMART LEARNING: EXECUTE WORK AND RECEIVE PROBLEM SOLVING SUPPORT

Maestro connect provides an intuitive Problem Solving Management System to help the operator to self solve any issue..

### SMARTECH: FASTER AUGMENTED SUPPORT

Maestro connect allows augmented reality support by means of Smartech: the head-wearable computers with wireless connectivity that will bring the interaction between customer and SCM service to a higher level.

### SMART WARRANTY: YOUR MACHINE ALWAYS IN PERFECT CONDITIONS

Together with scheduled maintenance contracts, you can take care of your asset by doubling the warranty from 1 year to 2 years\* for complete peace of mind!

\* Please read the complete contract to understand terms and conditions.

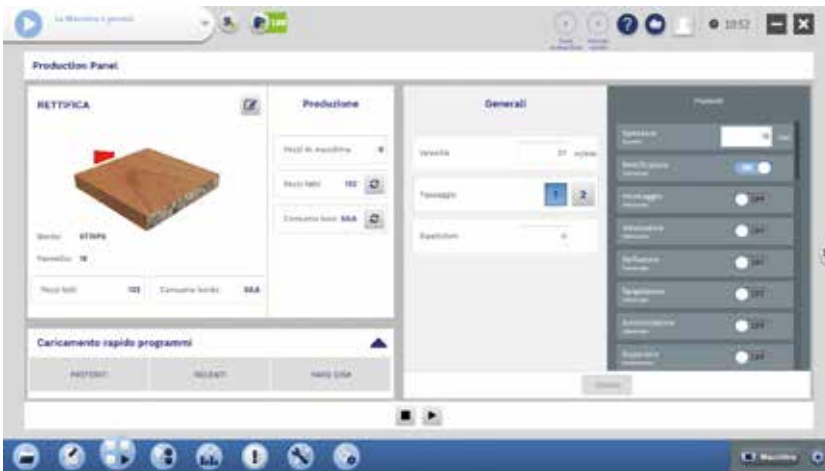

**MAESTRO ACTIVE EDGE AND MAESTRO CONNECT:  
PRODUCING IN SMART MODE**

Operator interface with immediate and intuitive panel programming thanks to the adaptive 3D design of the processing with real time preview.

Machine connection to a world of services (opt.)



**STARTOUCH CONTROL:  
ONE-TOUCH-USE OF THE MACHINE**

The touch-screen with customised graphics ensures error-free management, and a simple and intuitive access to the main functions.



**SIMPLE AS A TOUCH**

Production management directly by Bar code and label (opt.)

# TECHNICAL DATA

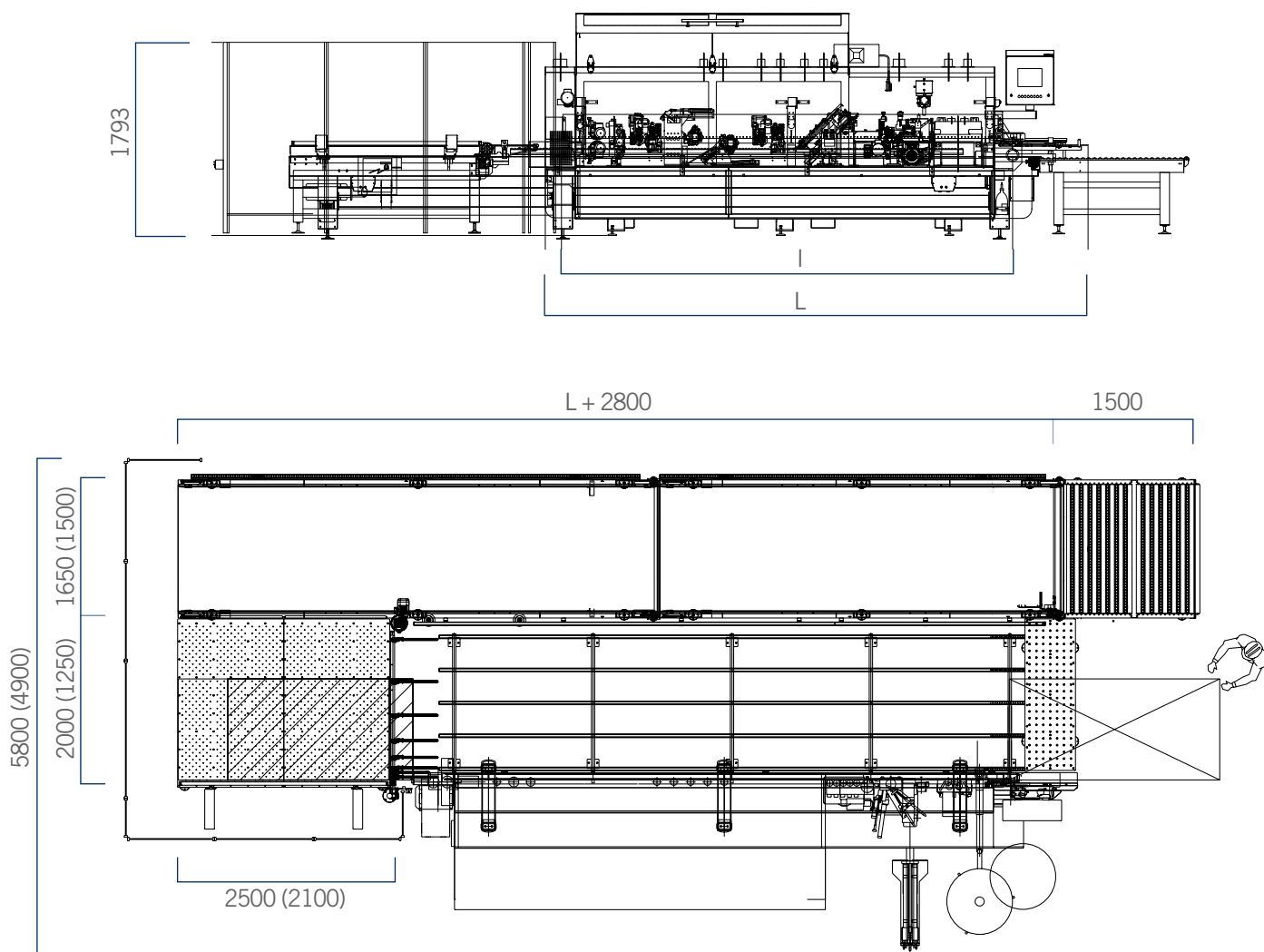

STEFANI MD	MT-ER2	MT-ERS	MT-ER4	MT-ER4S	T-S	T-MX	T-ER2	T-ERS	TER4S
Interaxis (I) mm	5300	6100	5700	6500	4300	5300	5700	6500	6900
Length (L) mm	6425	7225	6825	7625	5425	6425	6825	7625	805

STEFANI KD	ES	T-EL	ER2	T-ERL	T-ERS	T-FR2	HP T-ERL	HP T-ERS	HP T-FR2
Interaxis (I) mm	3900	4300	4300	4700	5100	5100	4700	5100	5100
Length (L) mm	4855	5255	5255	5655	6055	6055	5655	6055	6055

# COMPOSITIONS STEFANI MD

**stefani md/kd**  
automatic single sided edge banders

Feed speed up to 22 m/min

- thin edge 1<sup>st</sup> pass + 2<sup>nd</sup> pass - 22 m/min
- thin edge 1<sup>st</sup> pass - 22 m/min
- thin edge 2<sup>nd</sup> pass: - comp. MT-ER2, MT-ERS - 18 m/min  
- comp. MT-ER4, MT-ER4S - 22 m/min

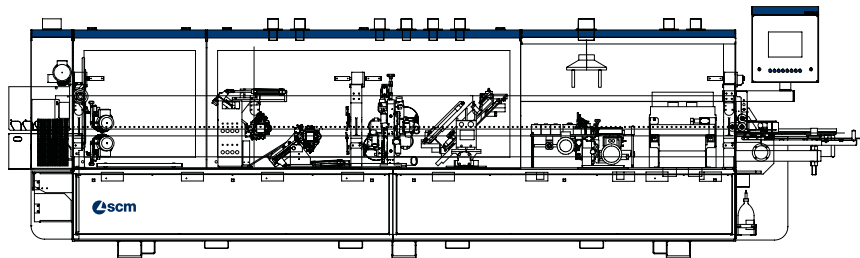

stefani md MT-ER2

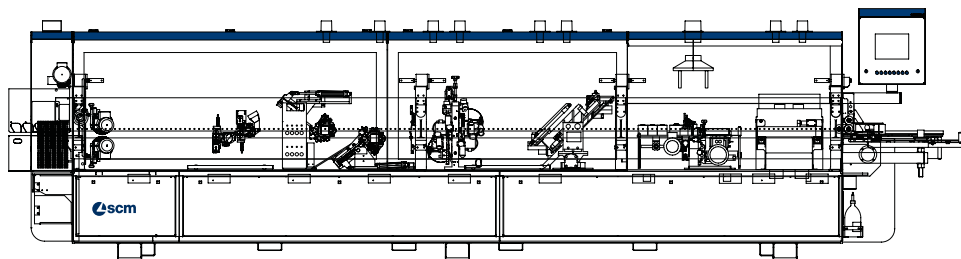

stefani md MT-ERS

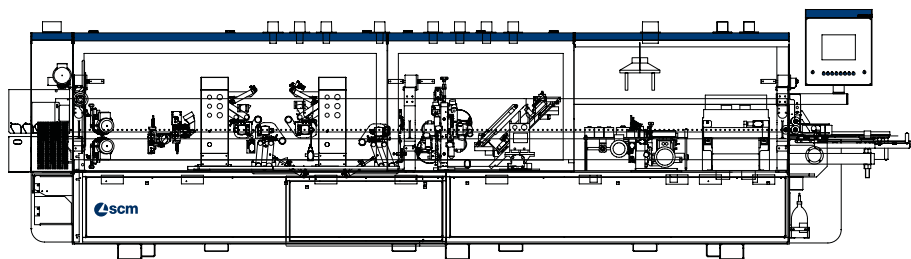

stefani md MT-ER4

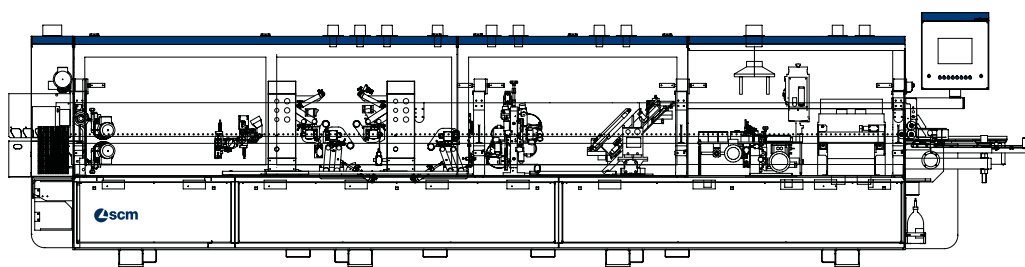

stefani md MT-ER4S

# COMPOSITIONS

## STEFANI MD

**Feed speed up to 25 m/min**

- thin edge 1<sup>st</sup> pass + 2<sup>nd</sup> pass - 25 m/min
- thick edge 1<sup>st</sup> pass - 25 m/min
- thick edge 2<sup>nd</sup> pass: - comp. T-ER2, T-ERS - 18 m/min  
 - comp. T-ER4S - 22 m/min

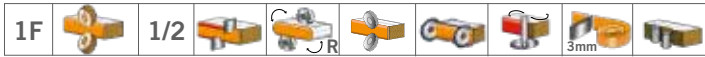
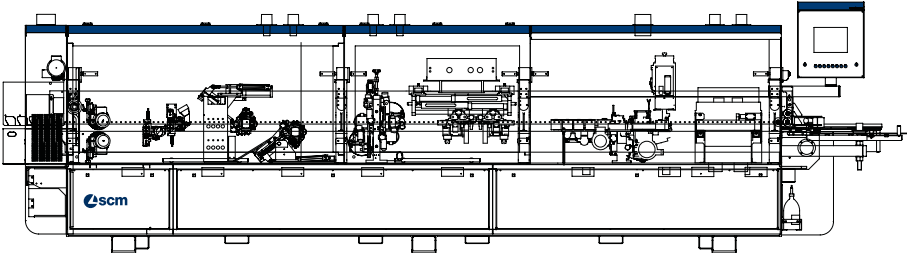

stefani md T-ER2

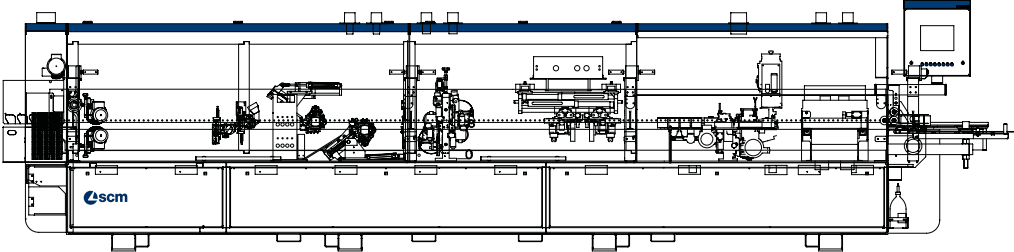

stefani md T-ERS

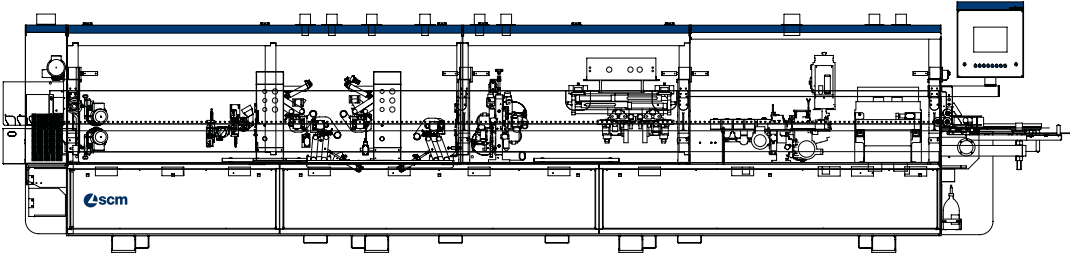

stefani md T-ER4S

**Feed speed up to 25 m/min**

- thin edge 1<sup>st</sup> pass + 2<sup>nd</sup> pass - 25 m/min
- thick edge 1<sup>st</sup> pass - 25 m/min
- thick edge 2<sup>nd</sup> pass - 25 m/min

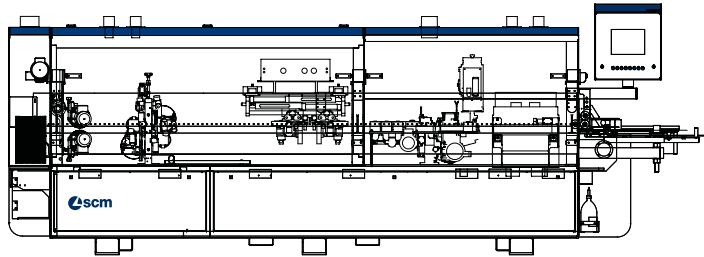

stefani md T-S

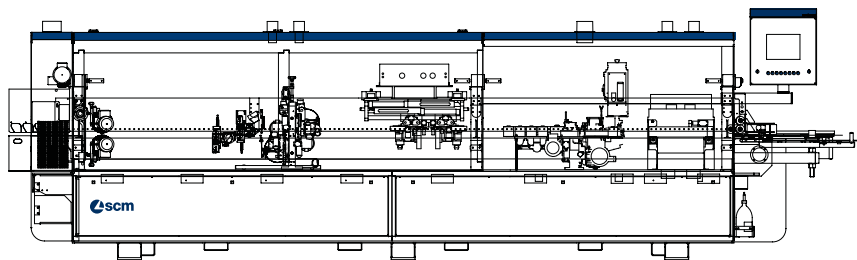

stefani md T-MX

**OPTIONAL UNITS FOR STEFANI MD**



Maximum noise levels measured according to the operating conditions established by **EN ISO 18217:2015**

Acoustic pressure in process **86** dbA (measured according to **EN ISO 11202-10**, uncertainty  $K \leq 4$  dB)

Acoustic power in process **99** dbA (measured according to **ISO 3746-2010**, uncertainty  $K \leq 4$  dB)

Even if there is a correlation between above mentioned "conventional" noise emission values and average levels of personal exposure over eight hours of operators, these last also depend on the real operating conditions, duration of exposure, acoustic conditions of the working environment and presence of further noise sources, this means the number of machines and other adjacent processes

# COMPOSITIONS

## STEFANI KD

Feed speed up to 20 m/min

- thin edge 1<sup>st</sup> pass + 2<sup>nd</sup> pass - 20 m/min
- thick edge 1<sup>st</sup> pass - 20 m/min
- thick edge 2<sup>nd</sup> pass - 18 m/min

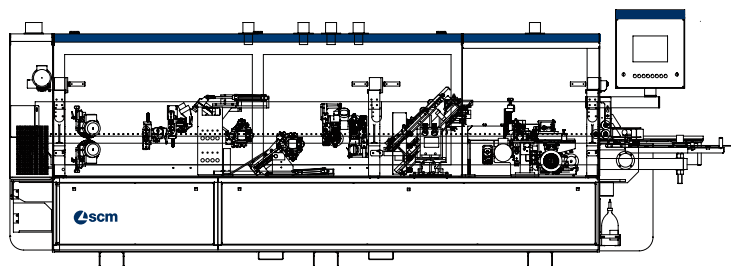

stefani kd ER 2

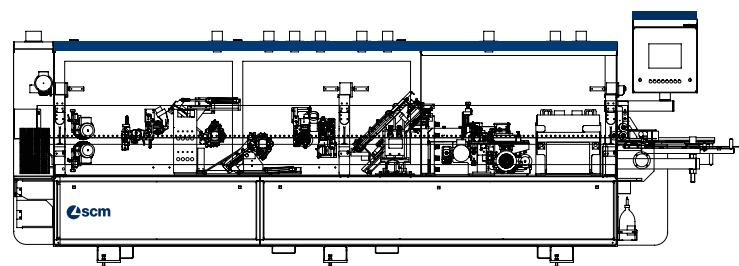

stefani kd T-ERL  
stefani kd HP T-ERL

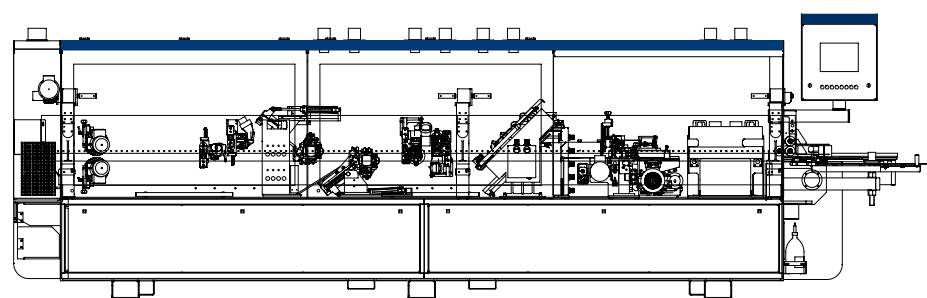

stefani kd T-ERS  
stefani kd HP T-ERS

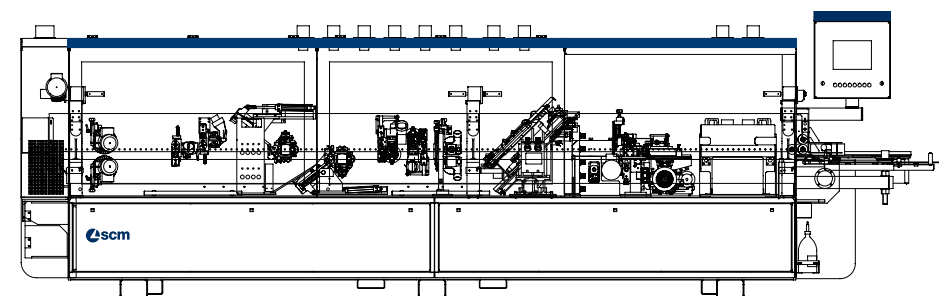

stefani kd T-FR2  
stefani kd HP T-FR2



**Feed speed up to 20 m/min**

- thin edge 1<sup>st</sup> pass + 2<sup>nd</sup> pass - 20 m/min
- thick edge 1<sup>st</sup> pass + 2<sup>nd</sup> pass - 20 m/min

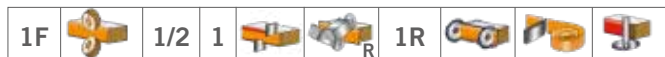
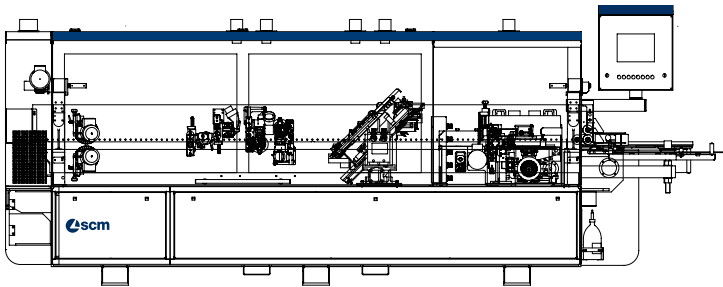

stefani kd ES

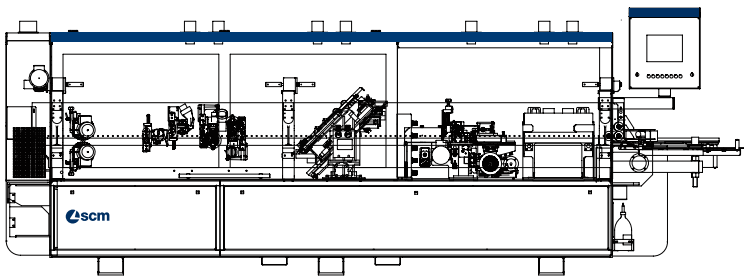

stefani kd T-EL

**OPTIONAL UNITS FOR STEFANI KD**



Maximum noise levels measured according to the operating conditions established by **EN ISO 18217:2015**

Acoustic pressure in process **83** dbA (measured according to **EN ISO 11202-2010**, uncertainty K ≤4 dB)

Acoustic power in process **99** dbA (measured according to **ISO 3746-2010**, uncertainty K ≤4 dB)

Even if there is a correlation between above mentioned "conventional" noise emission values and average levels of personal exposure over eight hours of operators, these last also depend on the real operating conditions, duration of exposure, acoustic conditions of the working environment and presence of further noise sources, this means the number of machines and other adjacent processes.

**COMPANY WITH  
QUALITY SYSTEM  
CERTIFIED BY DNV GL  
= ISO 9001 =**

*The technical data can vary according to the requested machine composition. In this catalogue, machines are shown with options. The company reserves the right to modify technical specifications without prior notice; the modifications do not influence the safety foreseen by the EC Norms.*

# PROMPT AND EXPERT TECHNICAL SUPPORT THROUGH A NETWORK OF 1000 TECHNICIANS AND AN INVENTORY OF 36,000 SPARE PARTS.

HIGHLY SPECIALISED TECHNICIANS, EFFICIENT MANAGEMENT AND 6 SPARE PARTS BRANCHES AROUND THE WORLD GUARANTEE A CLOSE, SAFE AND EFFECTIVE TECHNICAL SUPPORT.

## SERVICE

SCM provides a service that goes beyond the purchase, to guarantee the long term performance of your technological production system and peace of mind for your business.

### A COMPLETE RANGE OF AFTER-SALES SERVICES

- installation and start-up of machines, cells, lines and systems
- tailored training programs
- telephone support to reduce times and costs when machines are not working
- preventive maintenance programs to guarantee long term performance
- complete renovation of machines and plants to renew the added value of the investments
- custom upgrading to update machines and plants and meet new production requirements

## SPARE PARTS

SCM Group can count on 140 spare parts professionals worldwide to meet any request with real time shipments.



### 36,000 SPARE PARTS

Our spare parts inventory, with a value of 12 million euros, covers every single machine



### SPARE PARTS GUARANTEED

We guarantee also hard to find parts, with 3,5 million euros invested in "critical" spare parts.



### IMMEDIATE AVAILABILITY

Over 90% of orders received are carried out the same day thanks to the huge inventory available.



### 6 BRANCHES AROUND THE WORLD

The spare parts service can count on worldwide support (Rimini, Singapore, Shenzhen, Moscow, Atlanta, São Bento do Sul)



### 500 SHIPMENTS A DAY



# THE STRONGEST WOOD TECHNOLOGIES ARE IN OUR DNA

## SCM. A HERITAGE OF SKILLS IN A UNIQUE BRAND

Over 65 years of success gives SCM the centre stage in woodworking technology. This heritage results from bringing together the best know-how in machining and systems for wood-based manufacturing. SCM is present all over the world, brought to you by the widest distribution network in the industry.

**65** years history

**3** main production sites in Italy

**300.000** square metres of production space

**20.000** machines manufactured per year

**90%** export

**20** foreign branches

**400** agents and dealers

**500** support technicians

**500** registered patents

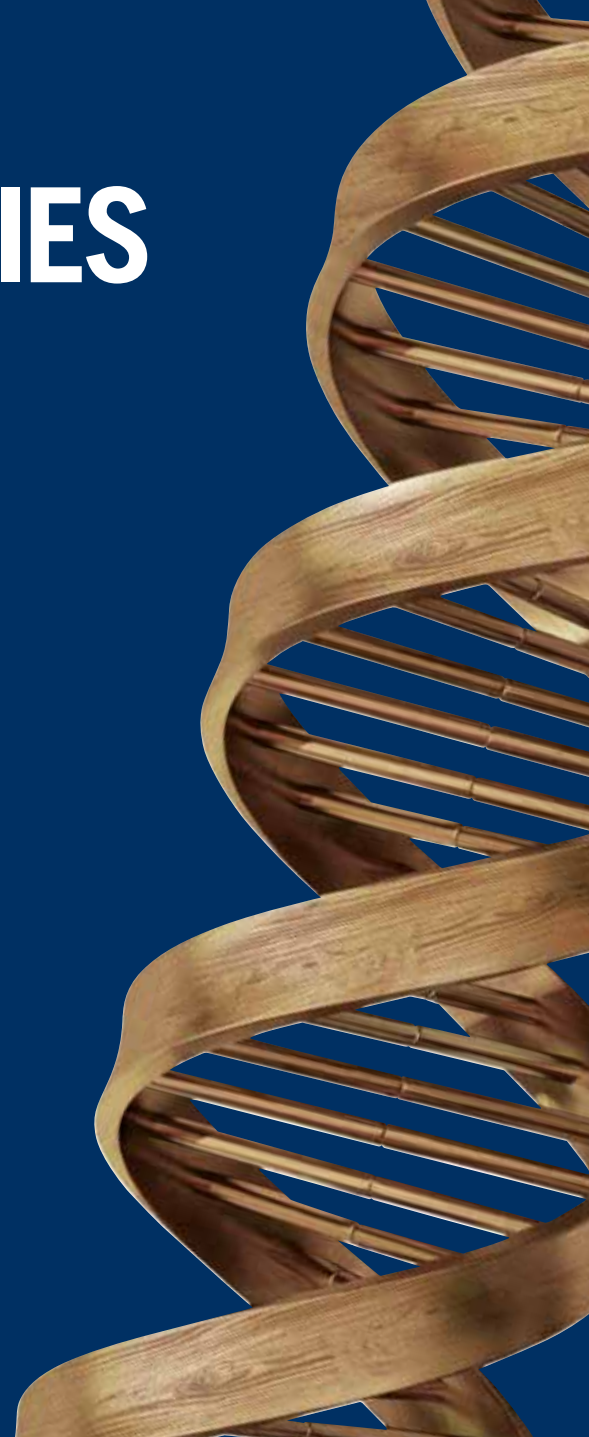

In SCM's DNA also strength and solidity of a great Group. The SCM Group is a world leader, manufacturing industrial equipment and components for machining the widest range of materials.

## SCM GROUP, A HIGHLY SKILLED TEAM EXPERT IN INDUSTRIAL MACHINES AND COMPONENTS

### INDUSTRIAL MACHINERY

Stand-alone machines, integrated systems and services dedicated to processing a wide range of materials.



WOODWORKING TECHNOLOGIES



TECHNOLOGIES FOR PROCESSING  
COMPOSITE MATERIALS, ALUMINIUM,  
PLASTIC, GLASS, STONE, METAL

### INDUSTRIAL COMPONENTS

Technological components for the Group's machines and systems, for those of third-parties and the machinery industry.



SPINDLES AND  
TECHNOLOGICAL  
COMPONENTS



ELECTRIC PANELS



METALWORK



CAST IRON



*is more*



**SCM GROUP SPA**

via Casale 450 - 47826 Villa Verucchio, Rimini - Italy  
tel. +39 0541 674111 - fax +39 0541 674274  
scm@scmgroup.com  
www.scmwood.com



00L0535754G