

# Skyline

Skyline è la linea di giunzione studiata per il piccolo utilizzatore. Le caratteristiche strutturali e la modularità del sistema danno garanzie di elevati standard qualitativi e durata nel tempo. Il tutto con un investimento molto contenuto.

Skyline, a jointing line designed specifically for small businesses. Its structural characteristics guarantee long life and high quality standards, while its modular design allows it to grow as you do. All these features with a relatively low investment.

Skyline es la línea de empalme estudiada para el pequeño productor. Las características estructurales y la forma modular del sistema brindan garantías de elevados estándares en cuanto a calidad y durabilidad se refiere, el todo con una inversión muy contenida.

Skyline ist eine Keilzinkenanlage, welche speziell für kleinere Betriebe entwickelt wurde. Der Aufbau garantiert eine lange Lebensdauer und einen hohen qualitativen Standard, während das modulare System eine Erweiterung der Anlage nach Ihrem Bedarf ermöglicht. All diese Eigenschaften sind möglich bei relativ geringer Investition.

Skyline est une chaîne d'aboutage étudiée pour les petites entreprises. Les caractéristiques structurelles et la modularité du système donnent d'office des garanties qualitatives élevées et de durée dans le temps. Le tout, pour un investissement très convenable.

Skyline это линия сращивания, для мелких предприятий. Структурные характеристики и особенности системы, обеспечивают высокие качественные стандарты и долговечность. И все это при очень умеренных капиталовложениях.

## Package loading finger jointer

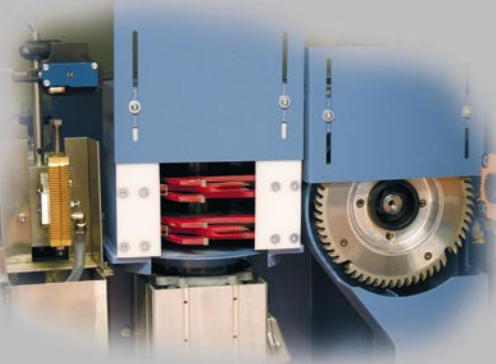

tools working area



press feeding system

press with 1 working level

## working data

### wood block

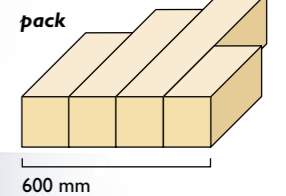
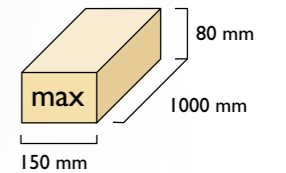
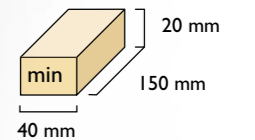

### horizontal & vertical

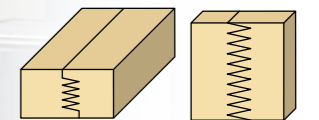

### pressing lengths

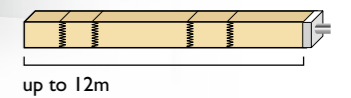

### productivity

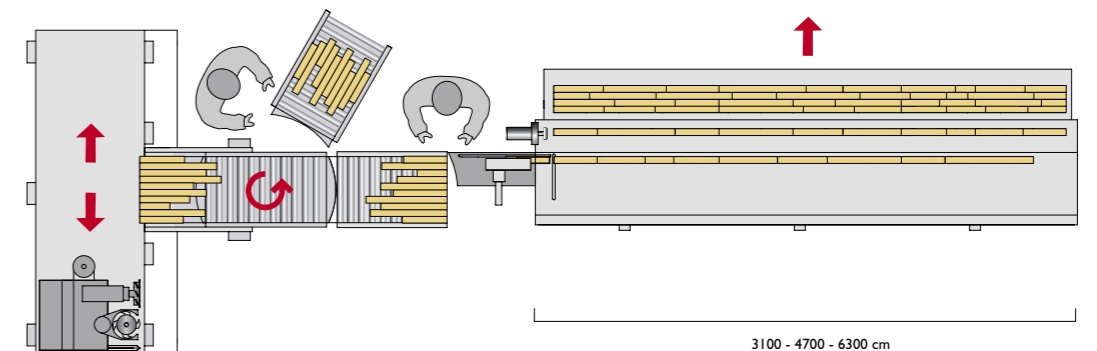
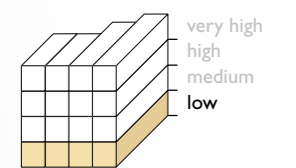

3100 - 4700 - 6300 cm