

STEFANI

Italiano - English - Español

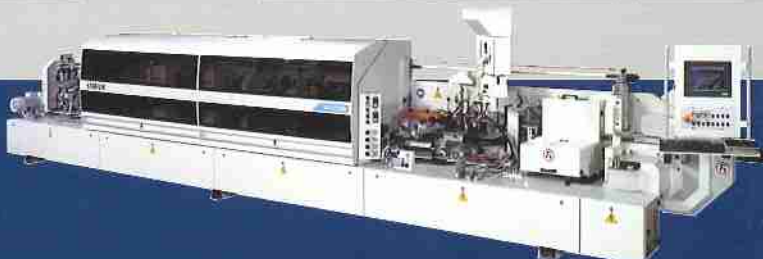

Bordatrici monolaterali elettroniche
NC single-sided edgebanders
Chapeadoras monolaterales electrónicas

Solution

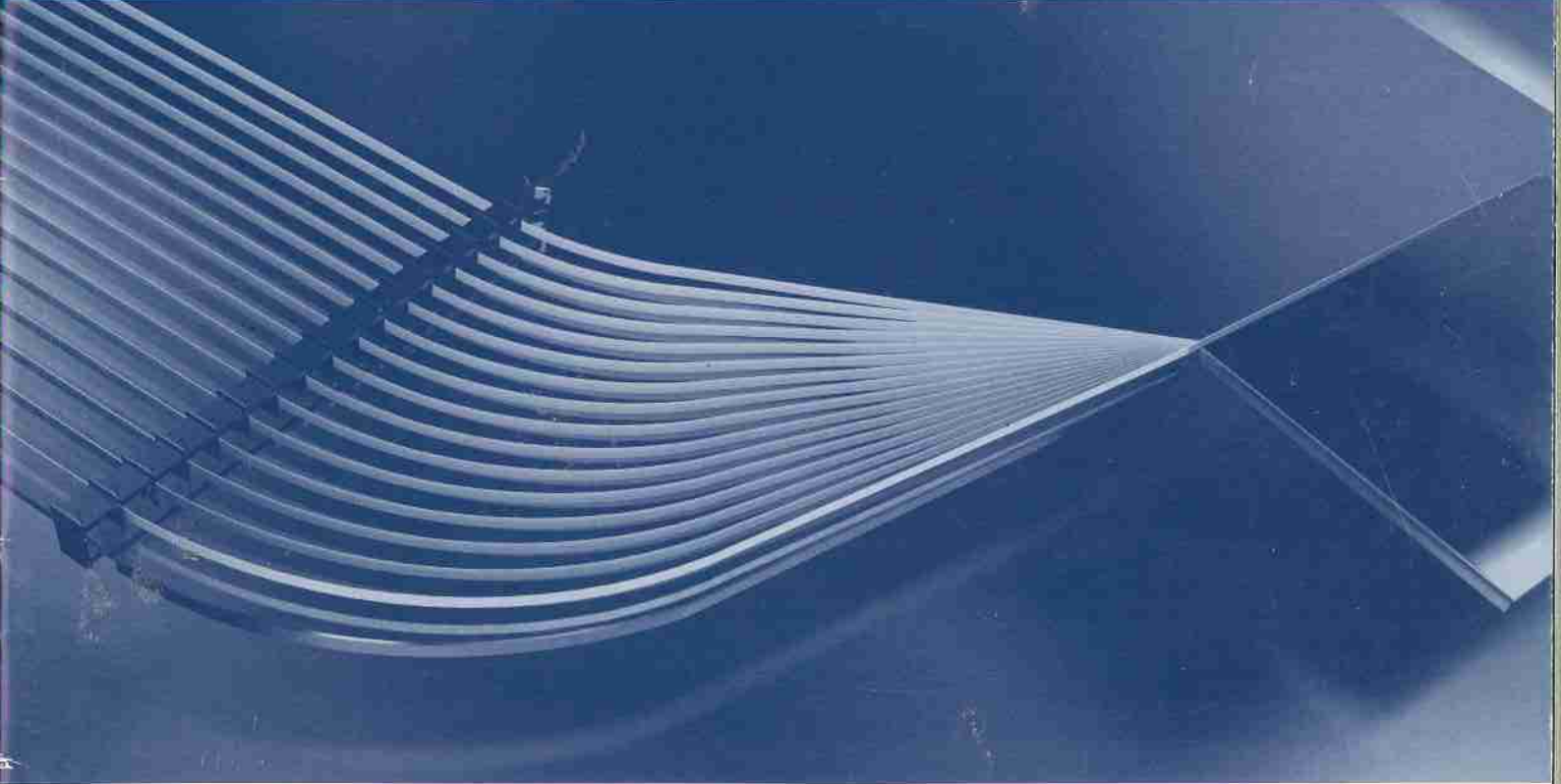

STEFANI

Elevata tecnologia di bordatura
 Top level edgebanding technology
 Elevada tecnología de chapeado

Solution soddisfa ogni esigenza di bordatura garantendo la massima precisione di lavorazione e l'affidabilità nel tempo. Solution è la sintesi della più elevata tecnologia di bordatura e può essere allestita per l'applicazione di bordi sottili, ABS e massello, per l'applicazione di bordi in alluminio o per lavorazioni softforming.

Solution meets every edgebanding requirements and guarantees the highest working precision and its reliability in the future. Solution represents the highest edgebanding technology and can be equipped for thin, ABS and solid wood edges processing, for aluminium edges processing or softforming processing.

Solution satisface cada exigencia de chapeado garantizando la máxima precisión de trabajo y fiabilidad en el tiempo. Solution lleva la más elevada tecnología de chapeado y puede ser equipada para la aplicación de cantos delgados, ABS y madera maciza, para la aplicación de cantos de aluminium o para trabajos softforming.

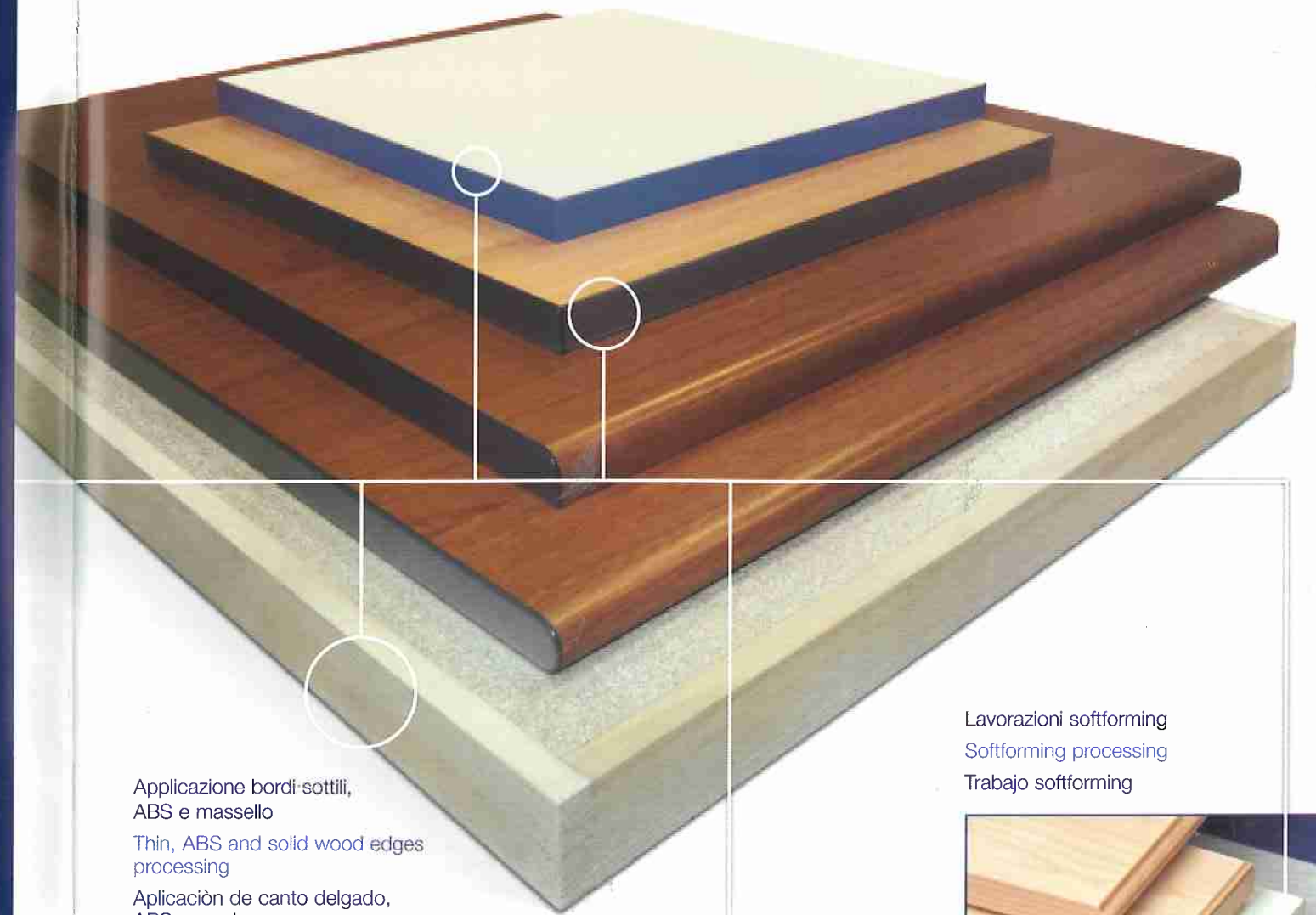

Applicazione bordi sottili,
 ABS e massello
 Thin, ABS and solid wood edges
 processing
 Aplicación de canto delgado,
 ABS y macizo

Lavorazioni softforming
 Softforming processing
 Trabajo softforming

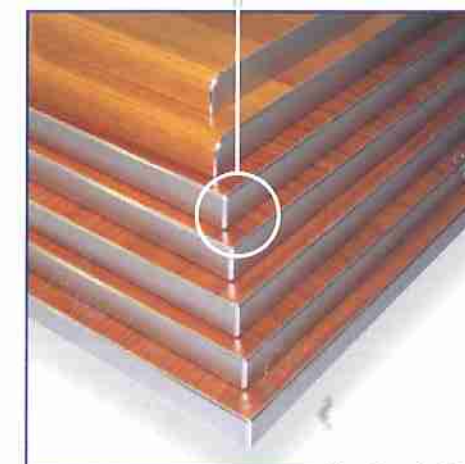

Applicazione bordi in alluminio
 Aluminium edges processing
 Aplicación de canto de aluminio



Solution

Bordatrice monolaterale elettronica
NC single-sided edgebander
Chapeadora electrónica monolateral

Sopratavole con possibilità di spostamenti
su guide lineari a ricircolo di sfere

Movable sub-bases on prismatic guides

Sobremesas con posicionamiento sobre
guías lineares con recirculo de bolas

Struttura in acciaio solida e resistente

Steel solid and duty beam

Structura de acero sólida y resistente

Pressore superiore in acciaio a cinghia larga
o a ruotini

Steel top pressure beam with large belt or
idle wheels

Prensor superior de acero con correa ancha
o con rodillos

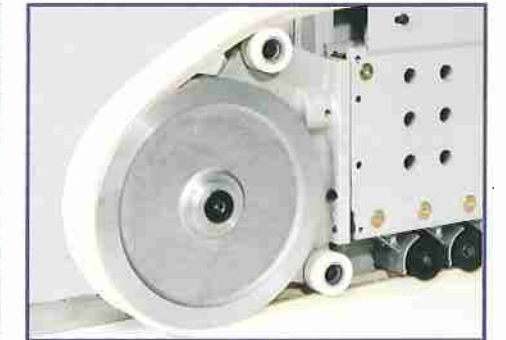
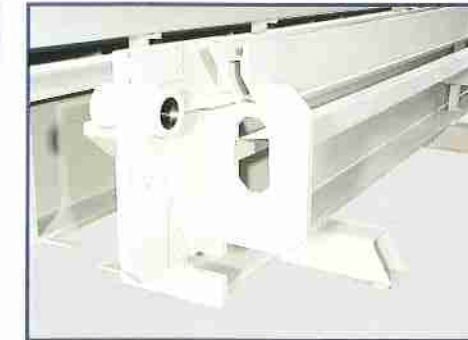

Preparazione del pannello

Panel preparation

Preparación del panel

Guida in entrata ad asse
controllato (opzionale)

NC controlled infeed
guide (optional)

Guía en entrada con eje
controlado (opcional)

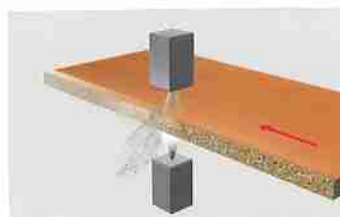
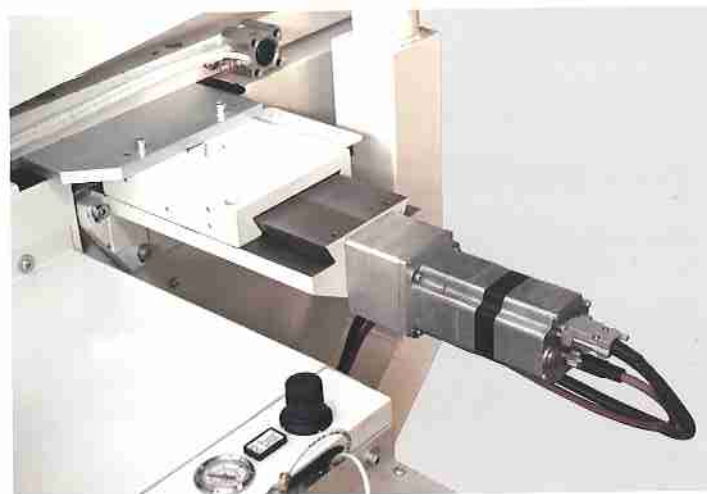

Gruppo antiadesivizzante

Anti-adhesive unit

Grupo antiadhesivo



Gruppo rettificatore

Pre-milling unit

Grupo rectificador

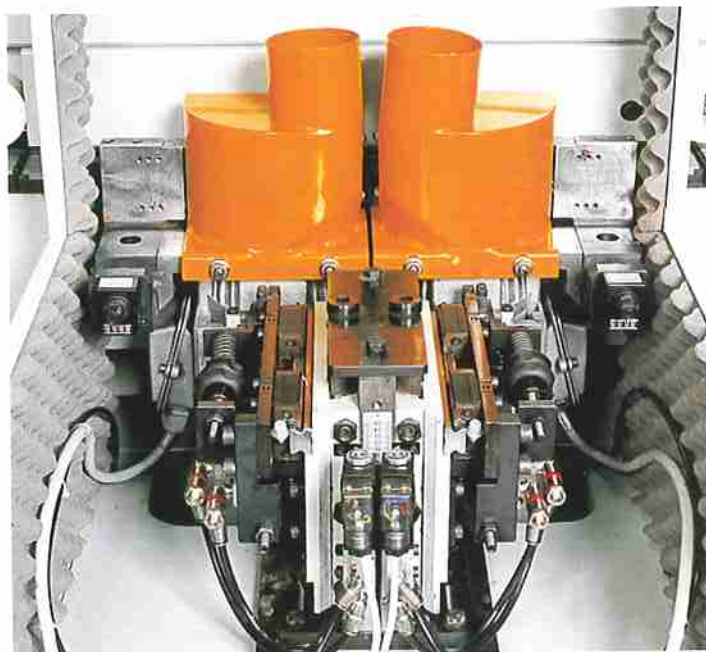

Incollaggio
del bordo

Gluing
application

Encolaje
del canto

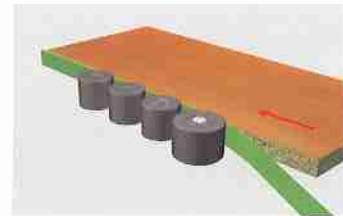

Gruppo incollaggio
Gluing unit
Grupo encolador



Portarotoli da 2 a 12 rotoli
2 to 12 coils holders
Llevarollos desde 2 hasta 12 rollos



Kit applicazione colla poliuretànica (PUR)
PUR glue process device
Kit aplicaciòn cola poliuretànica (PUR)

Gruppi di finitura

Finishing units

Grupos de acabado

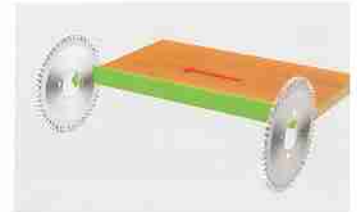

Gruppo intestatore
End-trimming unit
Grupo retesteador

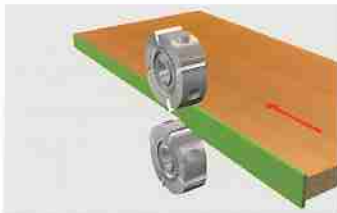

Gruppo rifilatore
Trimming unit
Grupo refilador

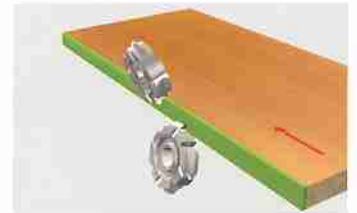

Gruppo spigolatore
Fine trimming unit
Grupo biselador



Gruppo spigolatore multifunzione
Multifunctional fine trimming unit
Grupo biselador multifuncion

Solution

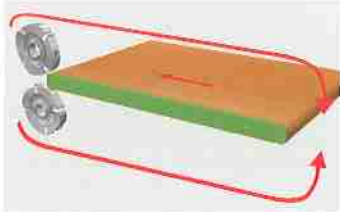

Gruppo arrotondatore-
spigolatore 2 motori con cambio
utensili automatico

2 motors corner rounding
trimming unit with automatic
tools change over

Grupo redondeador-biselador
2 motores con cambio
herramientas automático

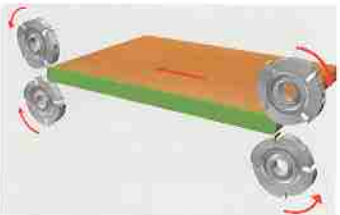
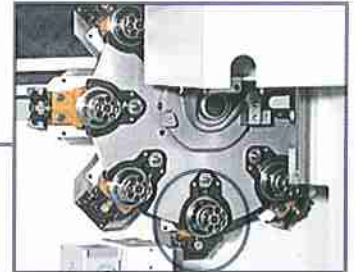
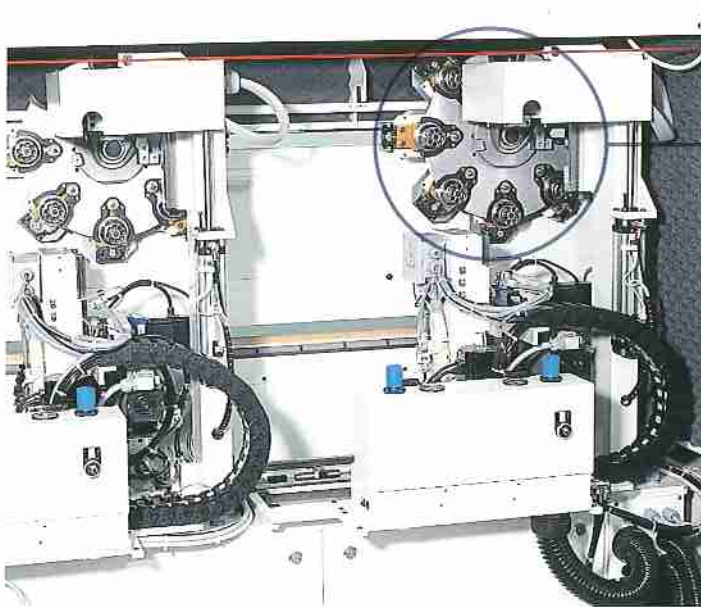

Gruppo arrotondatore
4 motori

4 motors corner
rounding unit

Grupo redondeador
4 motores

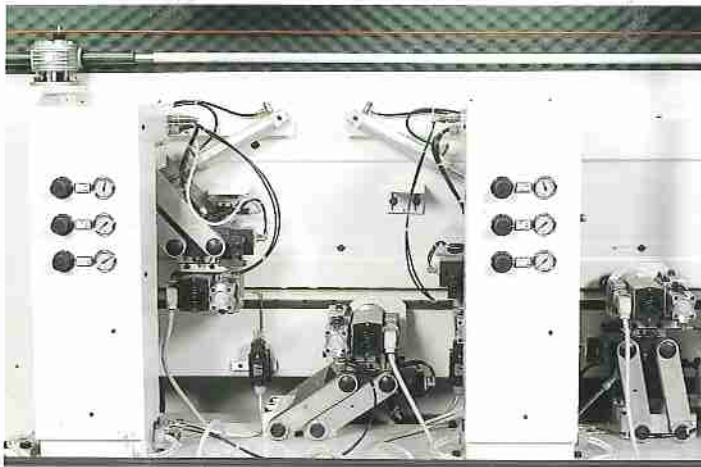

Gruppo arrotondatore
4 motori multifunzione

Multifunctional
4 motors corner rounding unit

Grupo redondeador
4 motores multifunción

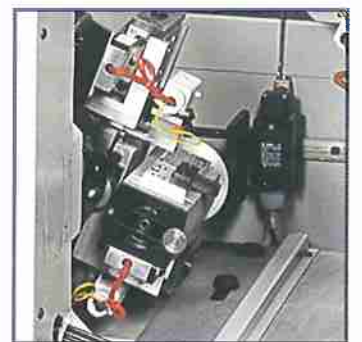

Gruppi di finitura

Finishing units

Grupos de acabado

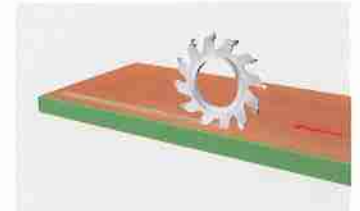
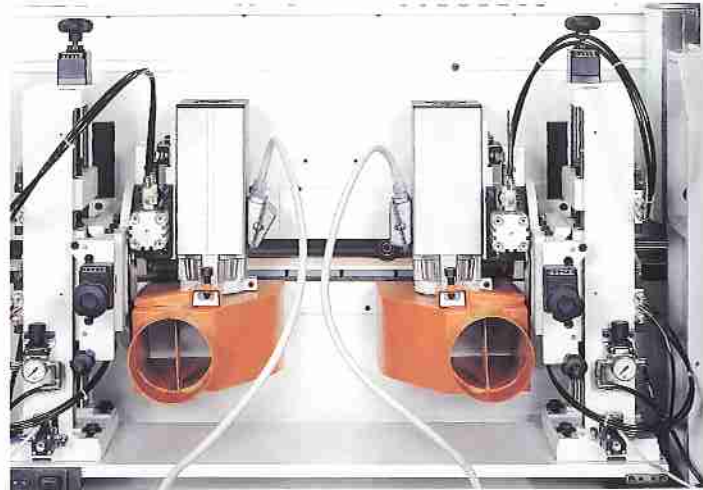
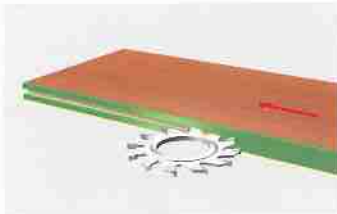

Gruppo toupie
Grooving unit
Grupo tupí para ranuras

Pulsante per sbloccaggio rapido dell'utensile
Quick release device button
Pulsador para el desbloqueo rápido de la herramienta



Gruppo toupie con sgancio rapido dell'utensile HSK
Grooving unit with HSK quick release device
Grupo toupie con desenganche rápido de la herramienta HSK

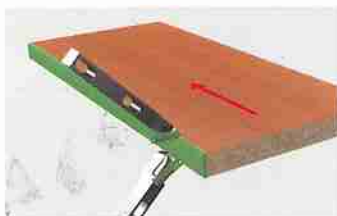

Gruppo raschiabordo
Edgescraping unit
Grupo rascador



Gruppo raschiabordo multifunzione
Multifunctional edgescraping unit
Grupo rascador multifunción

Solution

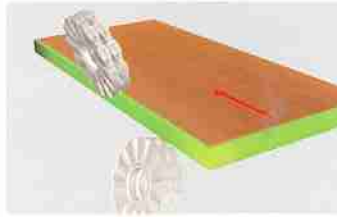
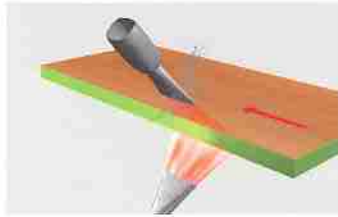
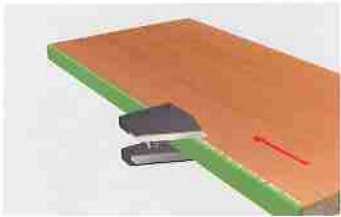
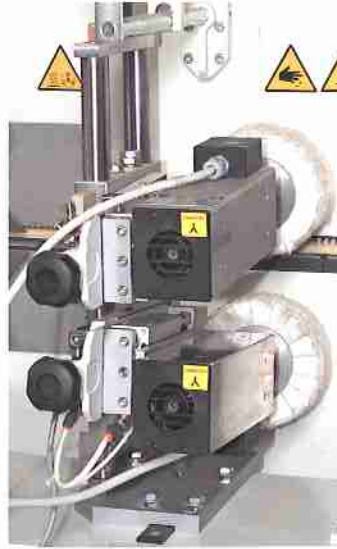

Gruppo raschiacolla
Gluescraping unit
Grupo rascacola

Gruppo rattivatore bordo
Edge brightening unit
Grupo avivador canto

Gruppo spazzole
Buffing unit
Grupo cepillos

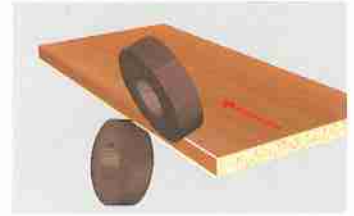
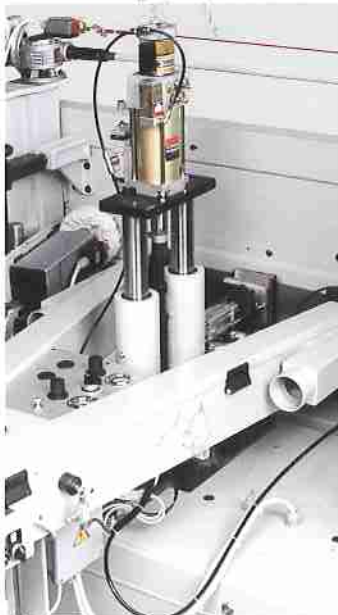

Gruppo levigatore
Sanding unit
Grupo lijador

Gruppo tinteggiatore
Staining unit
Grupo coloreador

Lavorazioni softforming

Softforming processing

Trabajo softforming

Profili softforming
Softforming profiles
Perfiles softforming

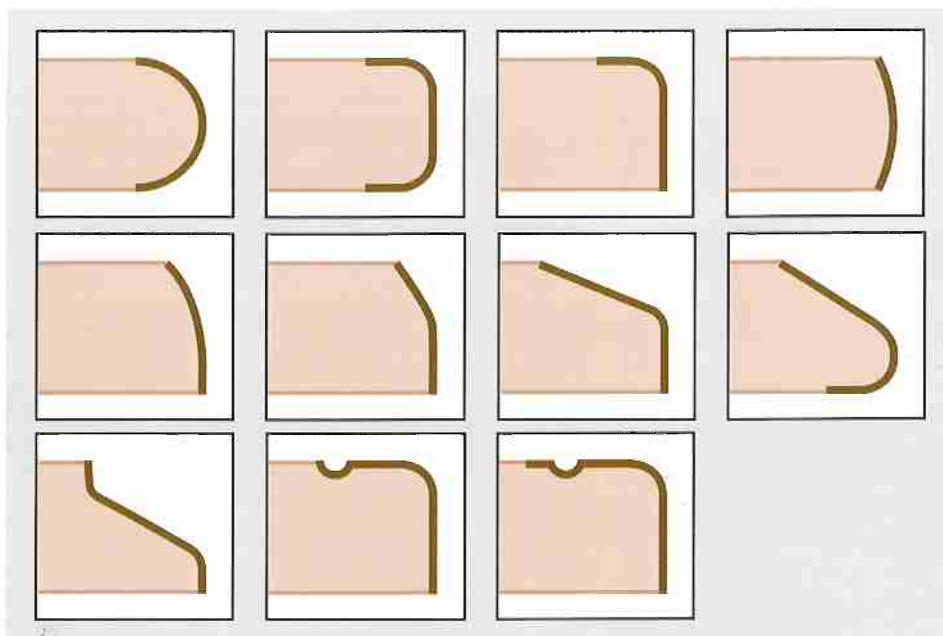

Gruppo profilatore softforming
Softforming shaping unit
Grupo perfilador softforming



Gruppo profilatore per complanare
Inlay shaping unit
Grupo perfilador para coplanar

Solution

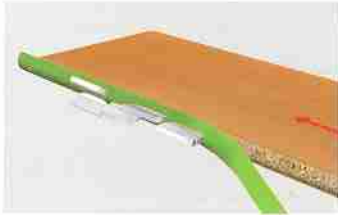

Gruppo incollaggio soffforming
Soffforming gluing unit
Grupo encolador soffforming

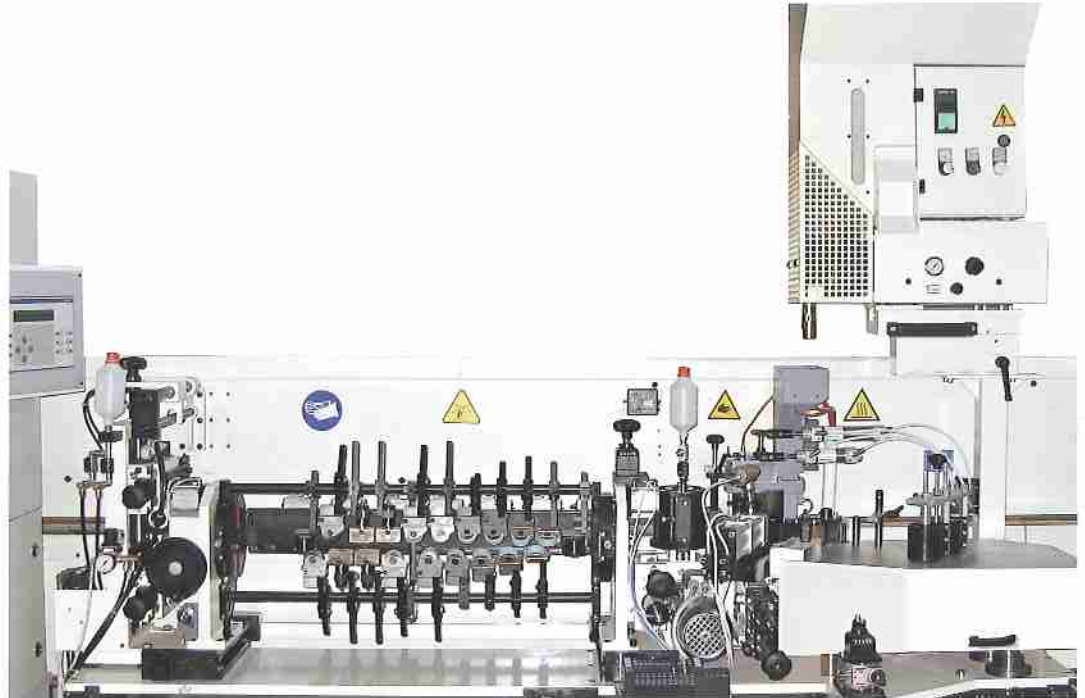

Cambio settori di pressione a revolver

Pressure sectors change over by revolver system

Cambio sectores de presión a revolver

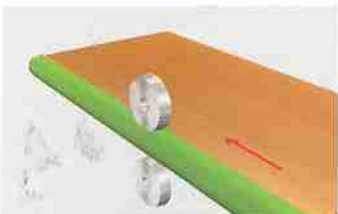
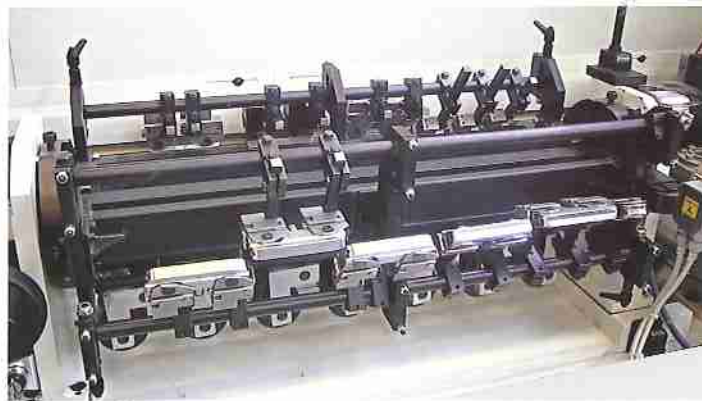

Gruppo cesoia longitudinale
Longitudinal shear unit
Grupo cizalla longitudinal

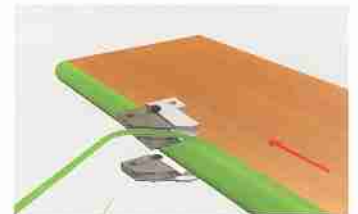

Gruppo raschiafilo
Scraping unit
Grupo rascador de aristas

Principali
opzionali

Main
optionals

Principales
opciones



Sistema di ritorno pezzi
Panel-return system
Sistema de retorno piezas

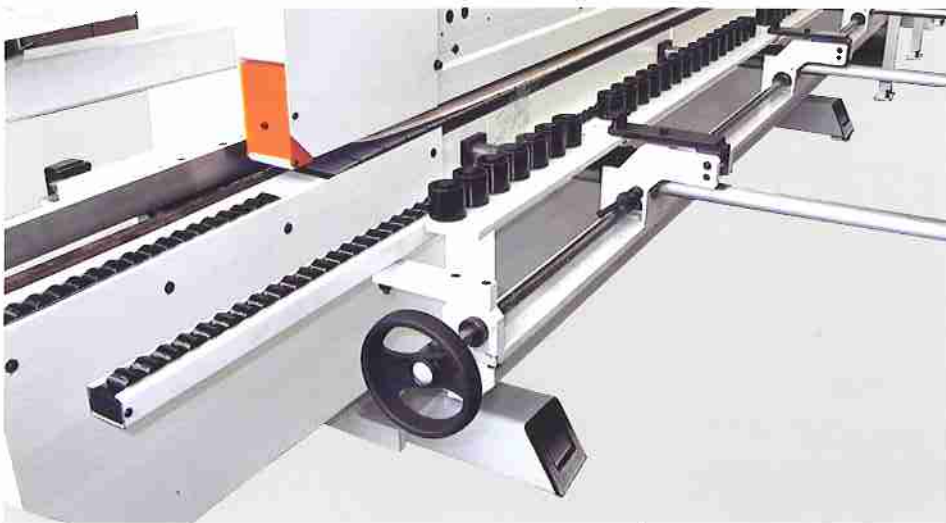

Spalla di contrasto
Counter shoulder
Sistema de contraste



Dispositivo distanziatore pannelli
Panel spacing device
Dispositivo distanciadore de paneles



Barra a dischi per la lavorazione di pezzi
stretti
Disk-type counter pressure bar for
processing narrow pieces
Barra de discos para el trabajo de piezas
estrechas



Lampade riscaldamento pannelli
Heating panels lamps
Lamparas para calentamiento

Linee di bordatura

Edgebanding lines

Lineas de chapeadoras

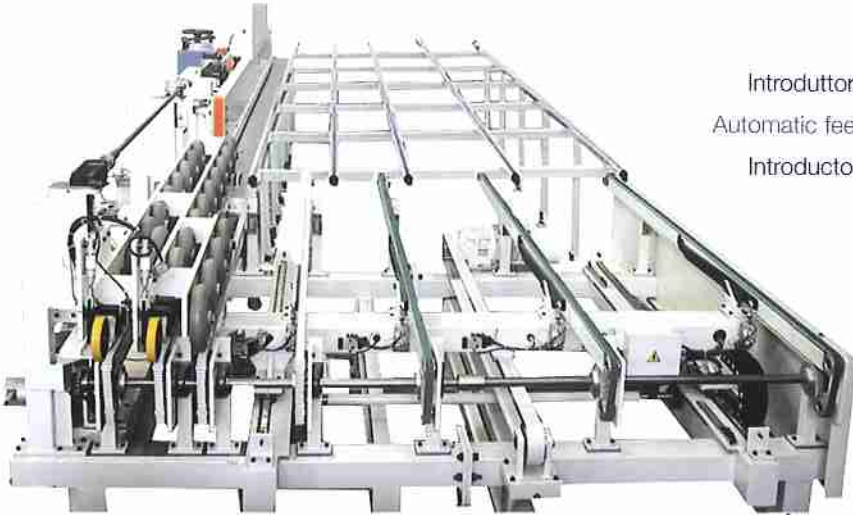

Introduttore elettronico
Automatic feeding system
Introducción electrónica

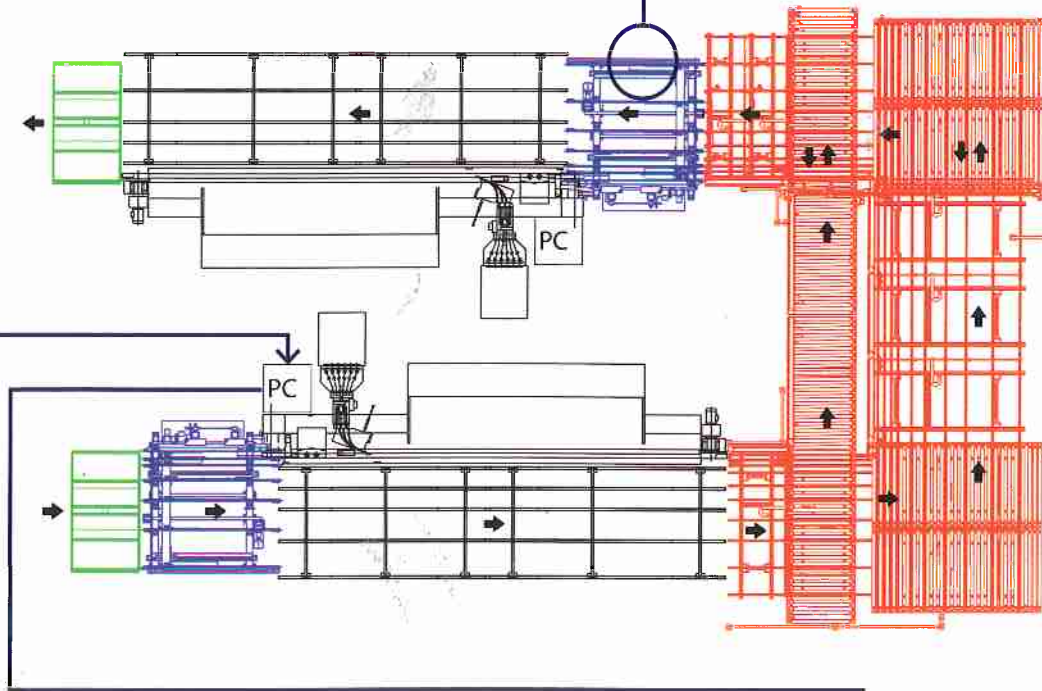

Linea di bordatura flessibile
Flexible edgebanding line
Linea de chapeadoras flexible



Lettore codice a barre
Bar code reader
Lector código de barras



Supervisore di linea Line supervisor Supervisor de linea

Interfaccia
ufficio-macchina

Office-machine
interface

Interfaz
oficina-màquina

Reparto produzione
Workshop
Sección producció



Ufficio
Office
Oficina

Attraverso il PC Office è possibile programmare la macchina direttamente dall'ufficio e ricevere dalla macchina i report di produzione.

Through the PC Office it's possible to program the machine directly from the office and to receive production reports directly from the machine.

Por medio del PC Office es posible programar la màquina directamente desde la oficina y recibir desde la màquina los reportes de producció.

Teleassistenza

Teleservice

Teleasistencia

Azienda cliente
Customer premises
Empresa cliente



Assistenza STEFANI
STEFANI after sales
department
Asistencia STEFANI

Con il servizio di teleassistenza viene assicurato al cliente un immediato intervento da parte dei tecnici STEFANI nelle situazioni di allarmi o errori durante il funzionamento della macchina.

Alla richiesta di intervento da parte del cliente, i tecnici STEFANI si collegano via modem al PC della macchina situata nello stabilimento cliente e, in tempo reale, effettuano operazioni sul software per riportare la macchina in condizioni ottimali. Tramite teleassistenza, inoltre, è possibile realizzare modifiche o aggiornamenti dei programmi su richiesta dal cliente.

Through teleservice is assured to the customer an immediate intervention from STEFANI technicians in situation of warnings during the machine process. Further to the request of intervention about the customer, STEFANI technicians will connect by modem to the PC situated on the customer machine and, in real time, they will resolve the software problems and re-set the machine in the best conditions. Besides, through teleservice it's possible to modify or update the programs according to customer requests.

Con el servicio de teleasistencia se asegura al cliente una inmediata intervenció por parte de los tècnics STEFANI en las situaciones de alarmas o errores durante el funcionamiento de la màquina. Con el pedido de intervenció por el cliente, los tècnics STEFANI se conectan via modem al PC de la màquina situada en la fàbrica del cliente y, en tiempo real, efectuan operaciones sobre el software para volver la màquina a las condiciones optimas. Por medio de teleasistencia, ademàs, es posible realizar modifcas o reajuste de los programas sobre pedido por el cliente.

Dati tecnici

Technical specifications

Características técnicas

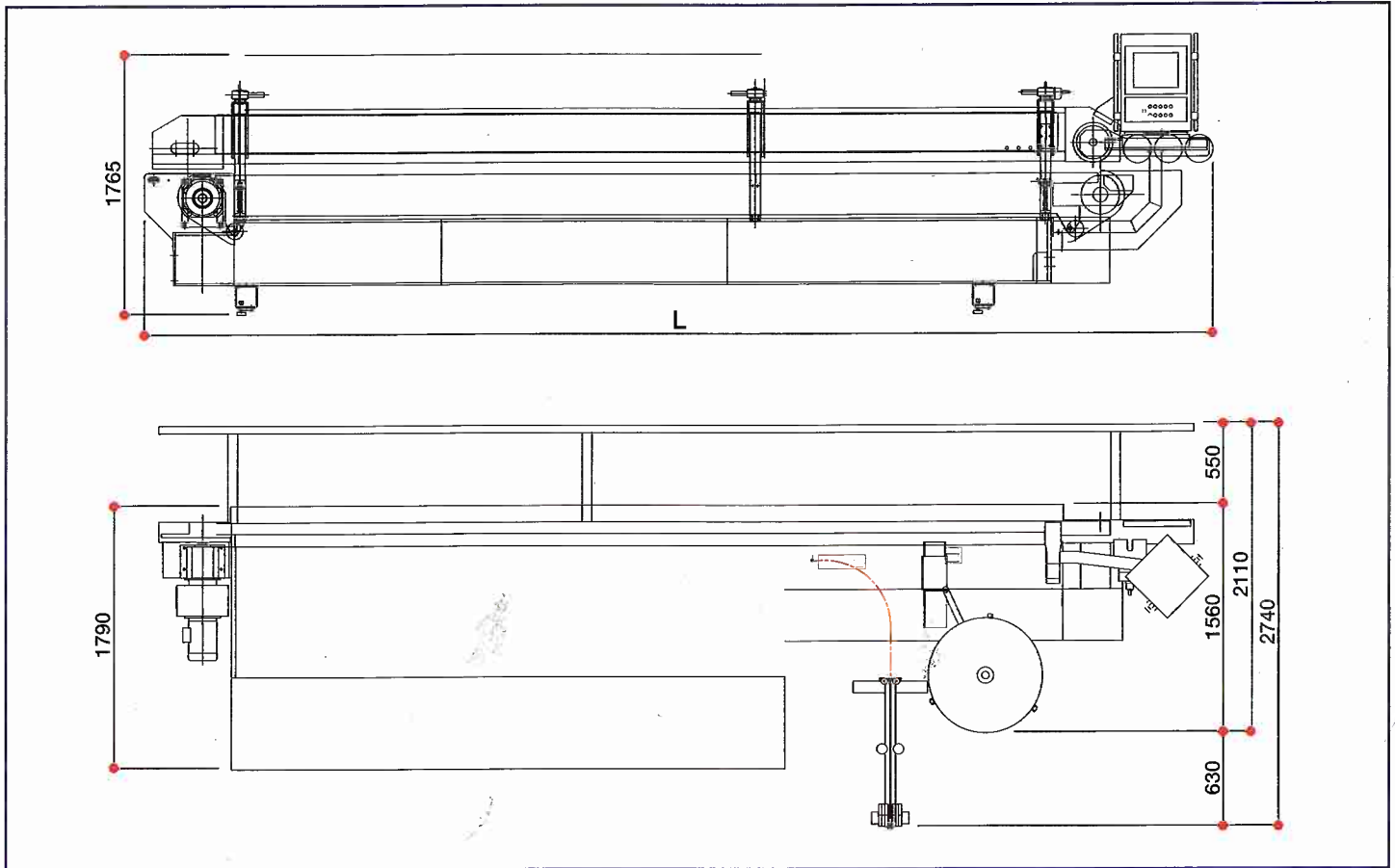

Solution	Solution R-47	Solution R-54	Solution R-60	Solution R-67	Solution R-73	Solution 47	Solution 54	Solution 60
Lunghezza totale (L) mm Total length (L) mm Longitud total (L) mm	5650	6350	6950	7650	8250	5650	6350	6950

Solution	Solution 67	Solution 73	Solution 80	Solution 86	Solution 93	Solution 99	Solution 106	Solution 112
Lunghezza totale (L) mm Total length (L) mm Longitud total (L) mm	7650	8250	8950	9550	10250	10850	11550	12150

Spessore minimo e massimo del bordo in rotolo Minimum and maximum coil material thickness	0,4 - 3 mm
Spessore minimo e massimo del bordo in striscia Minimum and maximum strip material thickness	0,4 - 25 mm
Spessore minimo e massimo del pannello Minimum and maximum panel thickness	10 - 60 mm
Velocità di avanzamento Feed speed	10-25 m/min

I dati tecnici possono variare in funzione della composizione scelta. Per esigenze dimostrative alcune foto riproducono macchine complete di accessori. Senza nessun preavviso i dati tecnici possono essere modificati, le modifiche non influenzano la sicurezza prevista dalle norme CE.

Technical specifications may vary according to the composition chosen. For demonstration purposes, several photographs show machines complete with accessories. The technical data can be modified without advance notice, the modifications do not influence the safety prescribed by the CE regulations.

Los datos técnicos pueden variar en función de la composición elegida. En este catálogo las máquinas han sido representadas con algunos accesorios. La empresa se reserva el derecho de modificar los datos y las medias sin previo aviso sin influir en la seguridad prevista de la certificación CE.

SINCERT



STEFANI

STEFANI:
scelta da clienti
esigenti

STEFANI:
The choice of
demanding customers

STEFANI:
elegida por
clientes exigentes



Oltre cinquant'anni di esperienza nel settore delle macchine per la lavorazione del legno, migliaia di bordatrici e squadraboardatrici operanti in tutto il mondo, hanno reso il marchio STEFANI uno dei più conosciuti ed apprezzati a livello internazionale, sinonimo di innovazione tecnologica, affidabilità, elevati standard qualitativi.

STEFANI è il partner ideale per la grande azienda del mobile che richiede macchine ed impianti ad elevata capacità produttiva.

Over fifty years' experience in the woodworking machinery industry, thousands of edgbanding and squaring-edgbanding machines sold throughout the world, have made the STEFANI name one of the most well-known and esteemed at international level.

A brand synonymous with technical innovation, reliability and high quality standards, STEFANI is the ideal partner for large-scale furniture makers who require machines and systems with high output capacities.

Más de cincuenta años de experiencia en el sector de las máquinas para la elaboración de la madera, miles de chapeadoras y escuadradoras-chapeadoras en función en todo el mundo han hecho de la marca STEFANI una de las más conocidas y apreciadas a nivel internacional, sinónimo de innovación tecnológica, fiabilidad, estándar de calidad elevados.

STEFANI es el soporte ideal de la grande empresa de muebles que necesita máquinas e instalaciones con una alta capacidad productiva.

STEFANI

STEFANI

SCM GROUP spa - Via del Lavoro, 1/3 - PO Box 168 - 36016 Thiene (VI) - Italy
Tel. +39/0445/359511 - Fax +39/0445/359599 - www.scmgroup.com - E-mail: stefani@scmgroup.com