

PRO VER A EDGE 15/18

NC EDGEBANDING
MACHINING CENTRE



 **BIESSE**



 **BIESSEGROUP**

TECHNOLOGY PRODUCES TOP RESULTS IN THE EDGEBANDING OF SHAPED ARTICLES



THE MARKET DEMANDS

a change in manufacturing processes which enables companies to **accept the largest possible number of orders**. This is coupled with the need to maintain high quality standards whilst offering product customisation with **quick and defined delivery times**, as well as responding to the needs of highly creative designers.

BIESSE RESPONDS

with **technological solutions** that influence and support technical expertise as well as process and material knowledge. **Rover A Edge15/18** is the new edgebanding NC centre with a gantry structure, designed to produce shaped, edge-banded panels on a single machine. The ideal solution for artisans and small/medium-sized businesses requiring excellent machining quality and ease of use with long-term reliability.



ROVER A EDGE 15/18

- ✔ RELIABILITY AND ROBUSTNESS, THANKS TO THE GANTRY STRUCTURE
- ✔ REDUCED TOOLING TIMES
- ✔ OPTIMUM EDGEBANDING STRIP ADHESION
- ✔ EXCELLENT FINISHED PRODUCT QUALITY
- ✔ SOLUTIONS THAT INCREASE MACHINE PRODUCTIVITY
- ✔ ERGONOMIC AND COMPACT.

OPTIMUM PERSONALISATION

Rover A Edge 15/18 allows various types of machining operation to be carried out on a single machine, guaranteeing quality, precision and full reliability over time.



4-AXIS CONFIGURATION

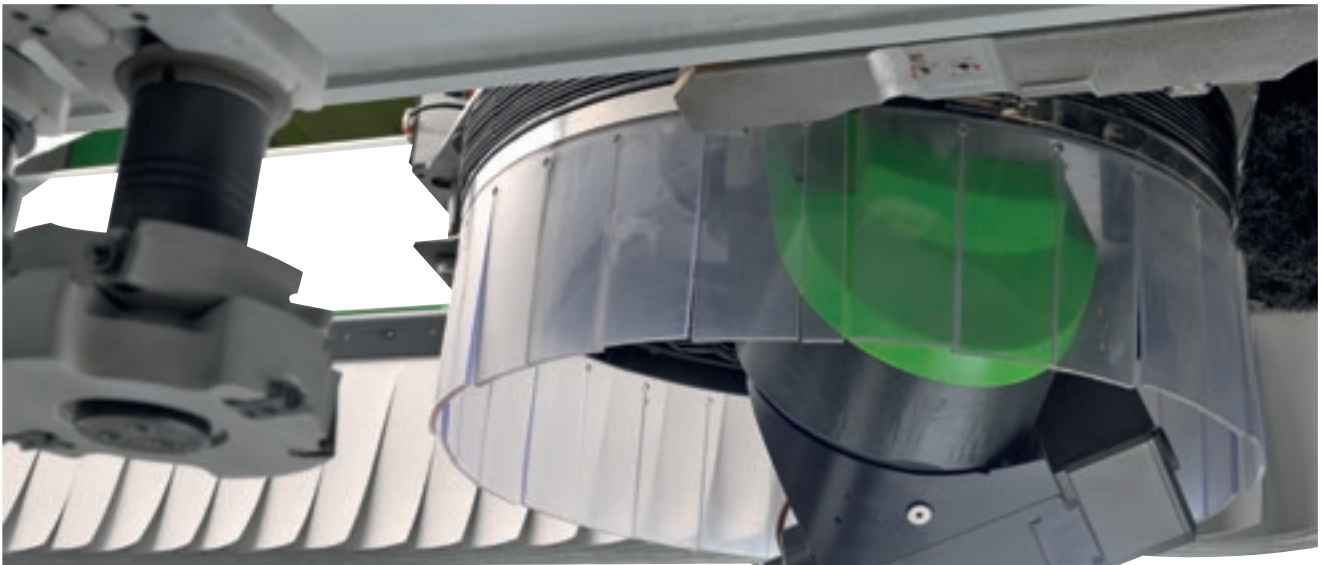

5-AXIS CONFIGURATION

The **cutting-edge 5-axis** working group supports the machining of pieces with complex shapes, ensuring quality and precision.

TOP-OF-THE-RANGE COMPONENTS



SHAPED EDGEBANDING

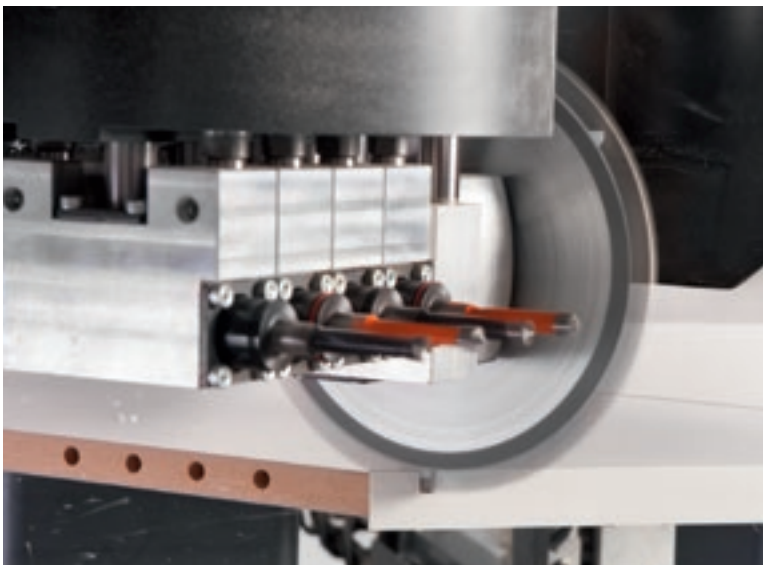

BORING

A full configuration of the operating section supports different machining operations whilst ensuring high product quality.

HIGH PRECISION AND RELIABILITY OVER TIME



The Rover A Edge 15/18 with gantry structure is designed to withstand high levels of machining strain, guaranteeing the quality of the end product.

The Biesse work table is guaranteed to hold the work piece securely in place and ensures quick and easy tool changeover.



ATS (Advanced Table-Setting System)
For the quick and easy manual positioning of the clamping systems.



SA (Set Up Assistance)
For the quick, easy and controlled manual positioning of the clamping systems. The linear sensors in the work table, along with the collision control function, reduce the risk of collisions

EPS (Electronic Positioning System)
For the quick, automatic positioning of the clamping systems in the programmed positions. The motors, along with the collision control function, ensure controlled positioning movements to reduce the risk of collisions.

FPS (Feedback positioning system)
evolution of the EPS system, with the addition of linear sensors that indicate the position of the carriages in real time, reducing the time needed to position them.

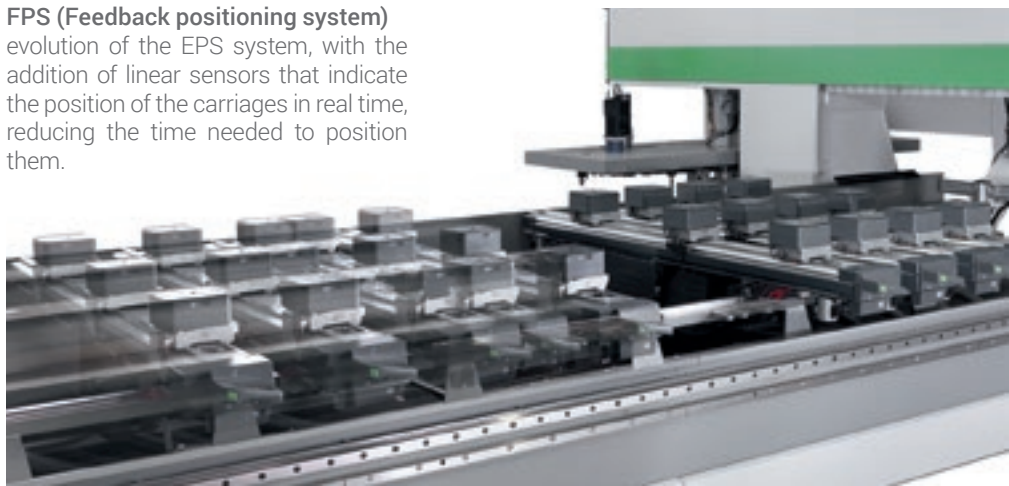

REDUCED TOOL CHANGEOVER TIME



Easy Zone

Supplementary vacuum system for the quick and easy clamping of several elements on the machine.

UP TO 30 PLACES, ENSURING THAT THE NECESSARY TOOLS ARE ALWAYS CLOSE AT HAND

Rack tool magazine with 12 or 23 places, with integrated pick-up.



Single-place front magazine on the X carriage, for aggregates and blades with diameter up to 290 mm.

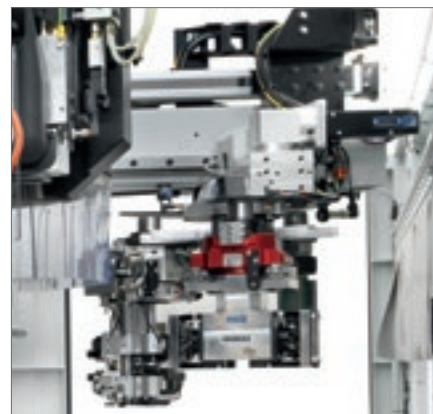

6-position Revolver always available on the Y carriage

THE POSSIBILITY TO SWITCH BETWEEN THE RACK MAGAZINE AND THE REVOLVER ONE SPEEDS UP TOOL CHANGE OPERATIONS, MAKING THE MACHINE MORE PRODUCTIVE.

ROVER EDGE

ROBUST EDGEBANDING

Maximum bonding, possibility of applying thin edges and 3D transparent edges, easy maintenance and panel cleaning during the machining cycle.

Edgebanding has always been based on applying glue directly to the panel; Biesse has followed this principle and applied it to straight edgebanding as well as shaped edgebanding performed by machining centres.



OPTIMAL EDGE GRIP



Optimal edge pressure quality during gluing on shaped panels thanks to the twinroller edge pressure system.



Similar to straight line edgebanding machines, **the glue is applied directly onto the panel** in order to ensure optimal adhesion quality. It supports the use of thin or transparent (3D) edges, as well as thicker and sturdier edges.



Glue feed occurs during the machining process via the granule feeding system within in integrated glue head. With the glue being stored in granules, only the required quantity is released for melting. This ensures optimal adhesion whilst preserving the glue characteristics.

FIRM, STABLE ADHESION

Biesse offers specific solutions for the use of polyurethane glues resistant to heat, humidity and water.



PU granule adhesives.



Additional glue pots fitted with quick-release electrical system for PU granule adhesives.



TM10 PRE-MELTER

New system for melting polyurethane glue in cartridges.

- ▶ High flexibility of use thanks to small cartridge size.
- ▶ Hermetically sealed system for extended glue life.
- ▶ Easy maintenance.

Biesse offers specific solutions for the highest quality of the finished piece through the use of RayForceSystem zero-joint technology.



RayForceSystem equipment, interchangeable with the use of EVA or PUR glues, for the highest quality of the finished product.

RAY FORCE SYSTEM

UNPARALLELED TECHNOLOGY

Biesse's high technology responds to increasingly complex market demands by developing an all-new technology like none other of its kind for the application of edges on shaped panels: RAY FORCE SYSTEM. Its revolutionary nature is based on an exclusive technique which uses infrared lamps to fuse a reactive layer. A solution that is comparable to Air Force System technology applied to linear edge.

The advantages are unmatched:

- ✓ maximum quality of finish,
- ✓ lower electrical consumption,
- ✓ ease of use.

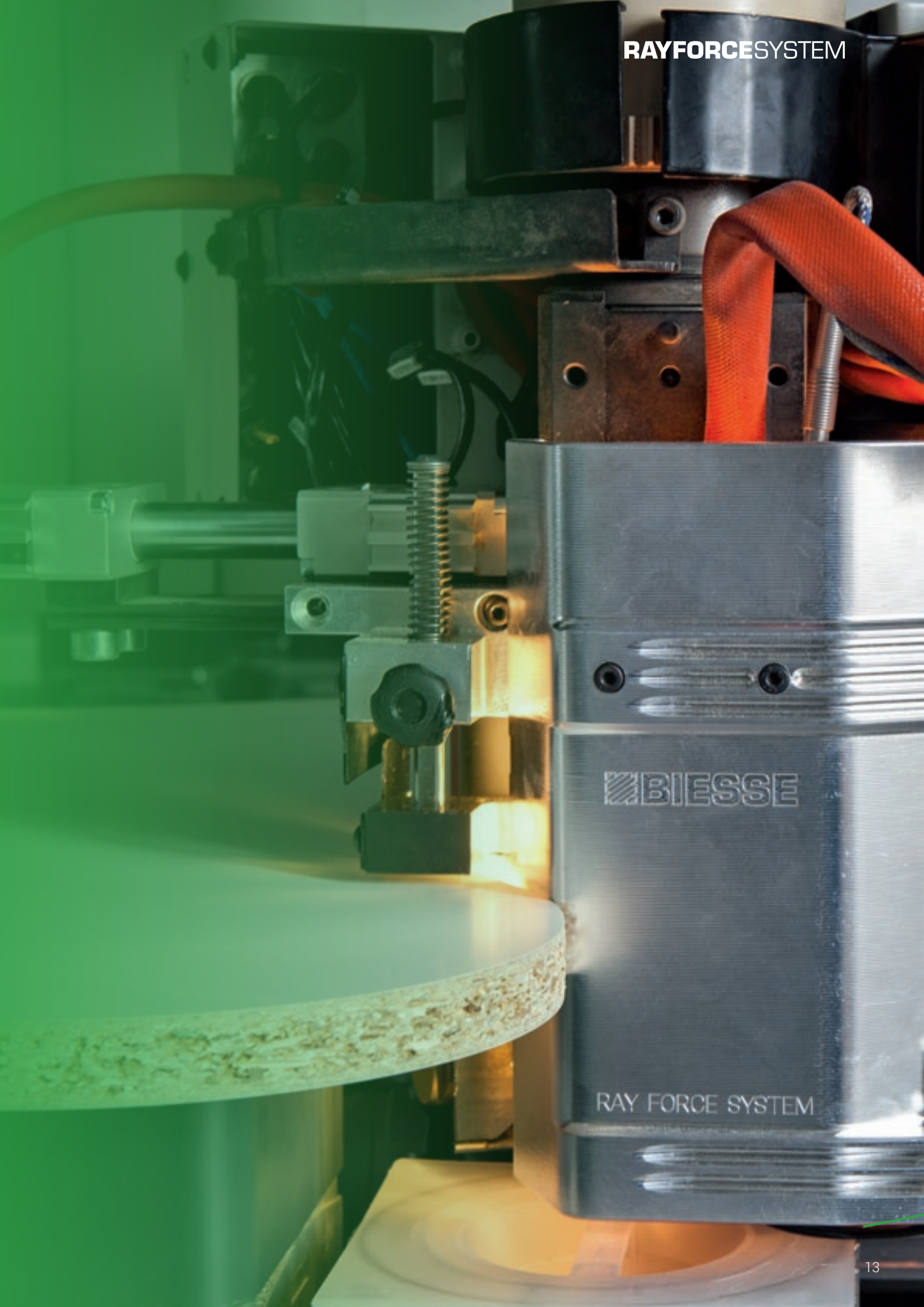

 BIESSE

RAY FORCE SYSTEM

SOLUTIONS THAT INCREASE MACHINE PRODUCTIVITY

Easy access to the banding material container and machine magazines for tooling.

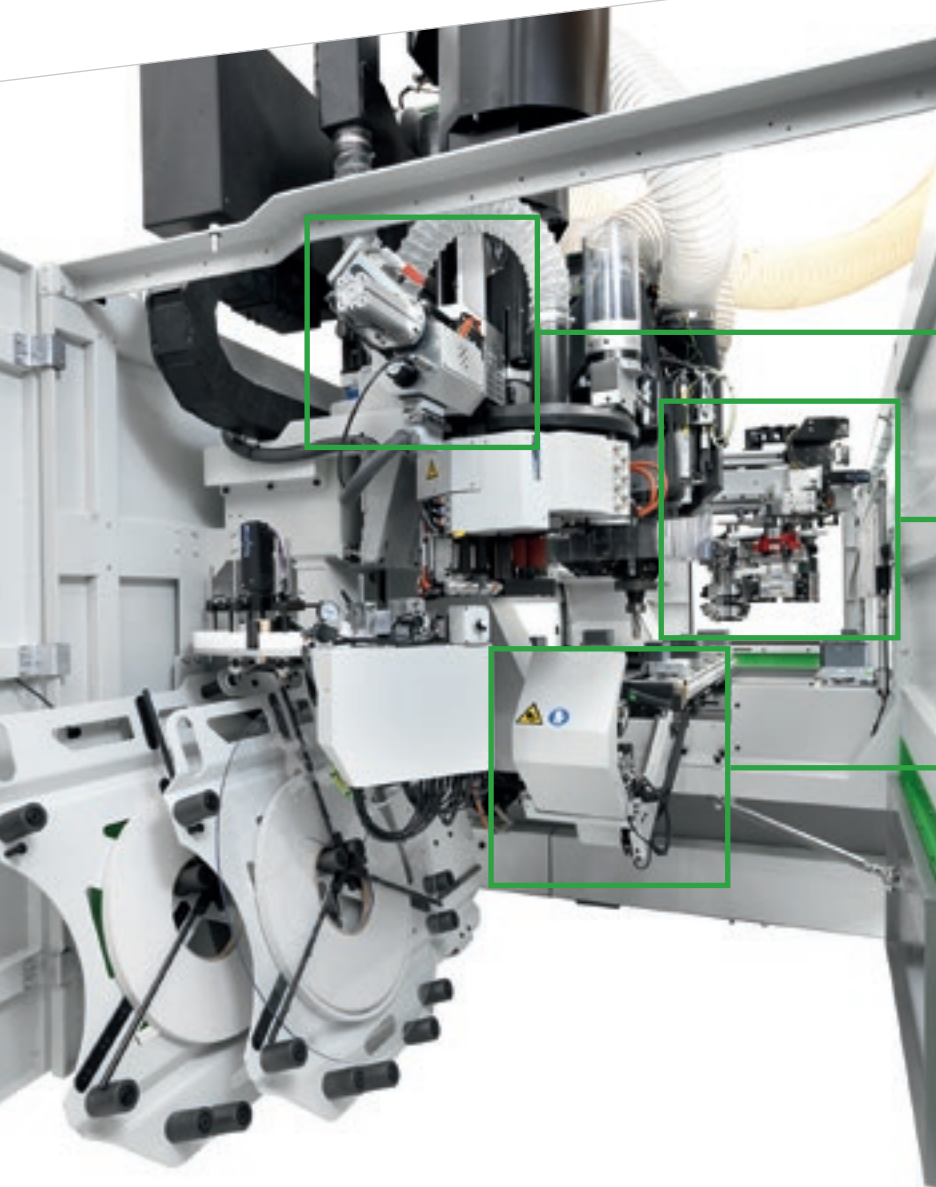

TM10 PRE-MELTER

REVOLVER MAGAZINE

FRONT MAGAZINE

PROMPT, QUICK COIL CHANGE

Front banding material container with: 1 coil, 2 coils, and/or manual feed with machining suspension.

The magazine for automatic edgebanding strip feed has 2 positions and is mounted on the front of the X carriage, allowing both thin and thick strips to be used during a single working cycle.

COMPACT AND ERGONOMIC



An extremely compact machining centre designed to adapt to the production space in which it is installed. Enables the operator to safely access all sides of the machine at all times, with no obstacles on the ground.

Y dual axis to carry out tool changes and edge feeding during machining.

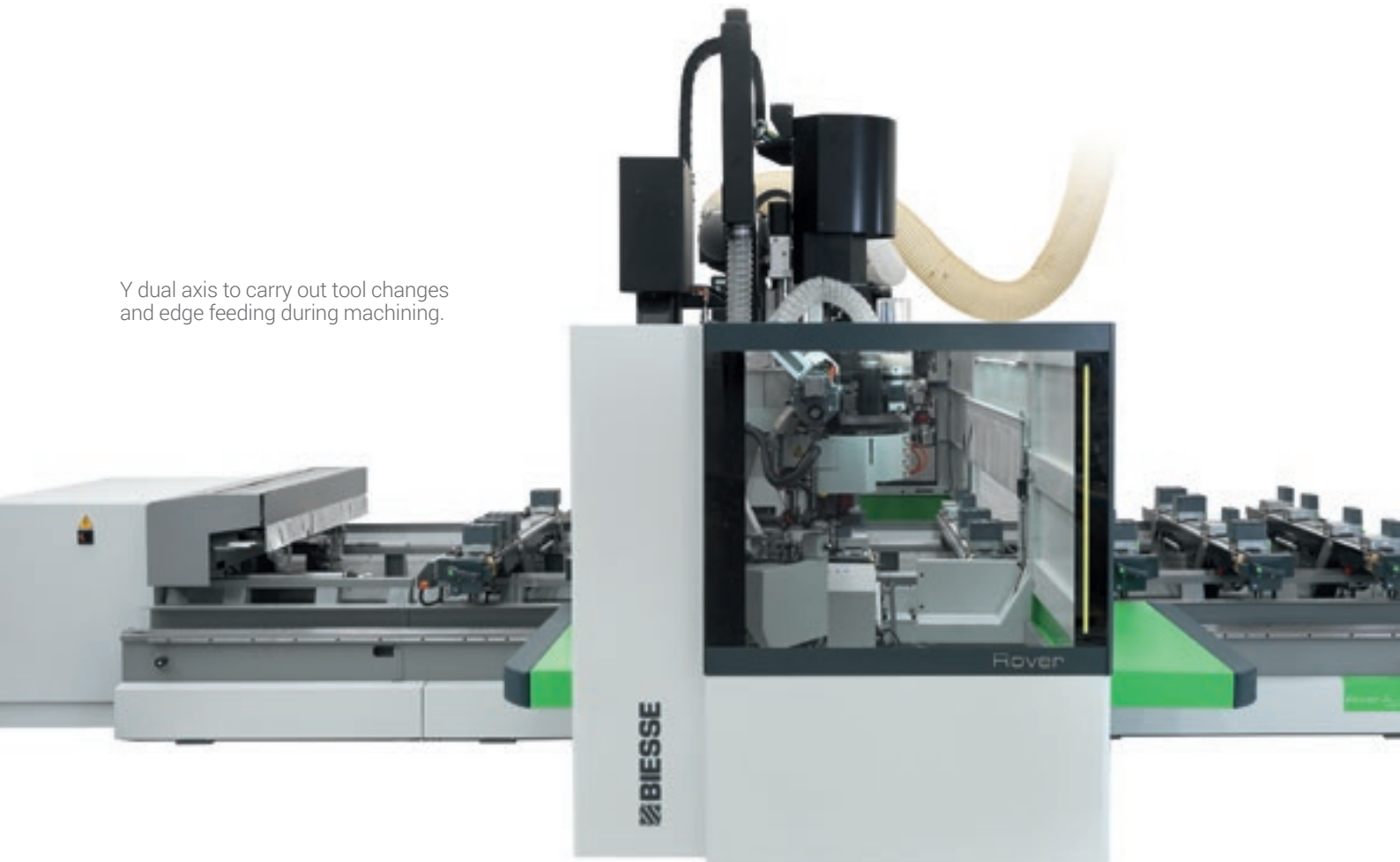

MAXIMUM EXPLOITATION OF THE WHOLE WORKING AREA

The carriage of the edgbanding unit, positioned on the same side as the working units, ensures the maximum exploitation of the working area available.

MANY SOLUTIONS FOR PERFECT FINISHES

AGGREGATES FOR THE FINISHING OF THE UPPER AND LOWER PART OF THE EDGE APPLIED ON THE PANEL

ET60C



Trimming aggregate, 30 mm or 18 mm minimum internal radius with flat knives.

ETG60C



Trimming aggregate, glue scraper, 30 mm minimum internal radius.

ETS60C



Trimming aggregate, non-stick liquid, 80 mm minimum internal radius.

EGS60C

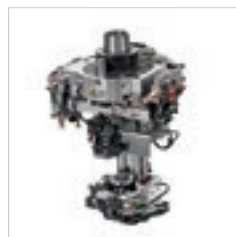

Edgebanding strip scraping aggregate, glue scraper, 30 mm minimum internal radius.

EF60B







Edgebanding strip finishing aggregate with three functions: trimming, edgebanding strip and glue scraping; 30 mm minimum internal radius.



Bench to facilitate the adjustment of the edgebanding strip finishing aggregates and can be used externally to the machine.

A COMPLETE RANGE OF AGGREGATES FOR ALL MACHINING OPERATIONS

					
Trimming/rounding tool	Trimming aggregate, 215 mm blade	260 mm blade for 5 axes edge trimming	300 mm blade for 5 axes edge trimming	Edge trimming/rounding aggregate with horizontal copying function	Finishing aggregate of the edgebanding applied on corners that end up on post-formed shapes.

TOP-QUALITY FINISHED PRODUCT



Blower and anti-adhesive liquid dispensing aggregate.



Trimming aggregate with non-stick liquid delivery.



Brusher aggregate with glue removal liquid dispenser.



Blower unit.



4-outlet blower unit for edgebanding strip finishing aggregates.

A COMPLETE RANGE OF AGGREGATES



Aggregate for milling of 90 internal corners.



MAXIMUM ERGONOMICS AND SAFETY FOR THE OPERATOR

BIESSE MACHINES ARE DESIGNED TO WORK IN COMPLETE SAFETY

Complete working unit protection: the front door has two openable panels, guaranteeing optimum visibility and easy access to the working units for tooling.



VARIOUS SOLUTIONS AVAILABLE

- ✔ the new "full bumper" solution, the work table can be accessed from every side
- ✔ Bumper plus photocells solution, combining productivity with ergonomics



Overlapping lateral curtain guards protect the working unit.

TECHNOLOGY AT THE SERVICE OF THE USER



PC in the electrical cabinet with Windows Realtime operating system and bSolid software interface.

Mobile console for easy access to all the functions and machine programming.

MAXIMUM VISIBILITY OF THE WORKING UNIT TO WORK IN COMPLETE SAFETY

LED bar with 5 colours, indicating the machine status in real time, allowing the operator to check the machine status at any point.



THE MOST ADVANCED TECHNOLOGY CLOSE AT HAND



BPAD

Wi-Fi control console for performing the key functions required during the preparation of the working area and the tooling of the working units and tool holder warehouses.

The bPad is a valuable tool for supporting teleservicing, courtesy of the camera and bar code reader functions.



BTOUCH

The new 21.5" touch screen which enables you to carry out all of the functions previously performed using the mouse and the keyboard, enhancing the direct interaction between the user and the device. Perfectly integrated with the bSuite 3.0 interface (and with later versions) and optimised for touch, this solution is incredibly simple, and makes the best possible use of the Biesse software functions installed on the machine.

BPAD AND BTOUCH ARE AN OPTIONAL FEATURE WHICH CAN ALSO BE BOUGHT AFTER PURCHASING THE MACHINE, IN ORDER TO IMPROVE THE FUNCTIONALITY AND APPLICATION OF THE TECHNOLOGY AVAILABLE.

INDUSTRY 4.0 READY



Industry 4.0 is the new industry frontier, based on digital technologies and on machines that speak to companies. The products driving this revolution can communicate and interact independently within production processes, which in turn are connected via intelligent networks.



Biesse is dedicated to transforming the factories owned by our customers into real-time factories that are ready to provide digital manufacturing opportunities. Intelligent machines and software become indispensable tools that facilitate the daily work of those who machine wood and other materials on a daily basis.

INDUSTRY 4.0 READY

LOADING AND UNLOADING SOLUTIONS

Automated cell for machining a batch of panels or doors.

Synchro is a loading/unloading device that transforms the Rover machining centre into an automatic cell for producing a stack of panels autonomously (without the need for an operator):

- ✔ it eliminates the risk of damage in the case of heavy panels that need to be handled by 2 operators
- ✔ it's easy to use, because the machining centre program also contains the Synchro command instructions
- ✔ it has limited overall dimensions, and can be positioned to the left or right of the machining centre
- ✔ it comes with various configurations, depending on the size of the panels to be handled and the layout of the stacks.



Device for the removal of porous panels or those with special finishes

It increases the reliability and the repeatability of the automatic cell operation cycle, even when machining porous materials or those with special finishes, which are often supplied with a protective film.



Panel pick-up device with automatic positioning of the suction cup holder rods

In accordance with the size of the panel to be picked up:

- ✔ no operator intervention is required to attach or remove the suction cup holder rods
- ✔ Idle time during format change operations is dramatically reduced
- ✔ the risk of collisions caused by incorrect tooling operations is reduced.

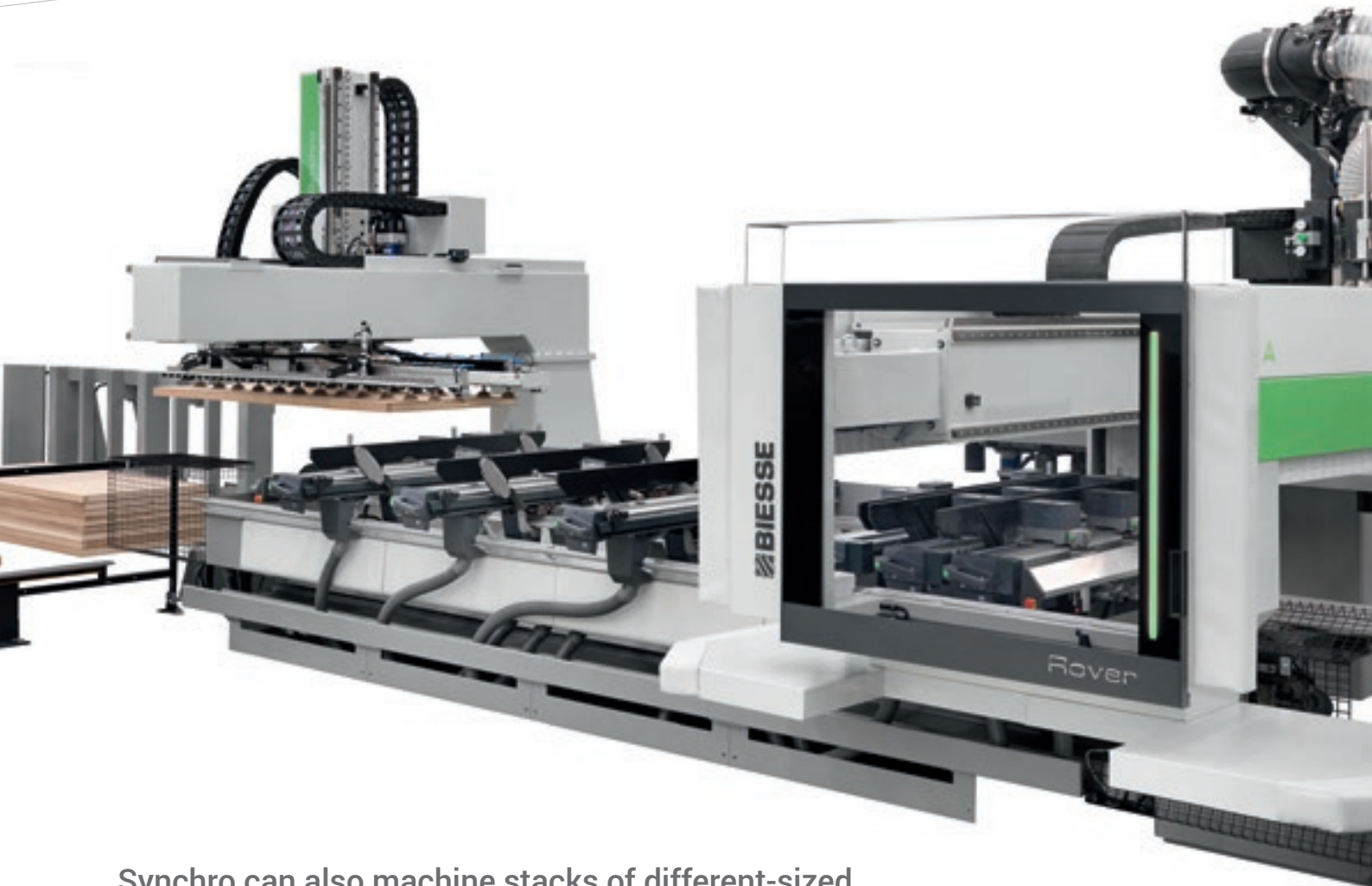

Synchro can also machine stacks of different-sized panels, thanks to stack reference device and the panel pre-alignment cycle, which is performed while the machine is running, while the Rover machining centre processes the previous panel.

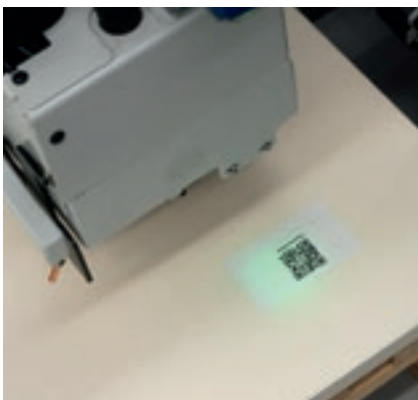

Bar code scanner for automatically sending the machining program of the Rover machining centre.

Dedicated configuration for the simultaneous loading/unloading of 2 panels, to maximise machining centre productivity:

- ✔ 0 operators
- ✔ 1 machining program
- ✔ 2 panels

OPTIMAL CLEANING OF MACHINED PIECE AND WORK AREA



Motorised conveyor belt for the removal of chips and waste.



NC-controlled deflector (chip conveyor).



Adjustable suction hood with 8 settings (for 4 axes) and 12 setting (for 5 axes).

WORKING UNIT CONFIGURATION

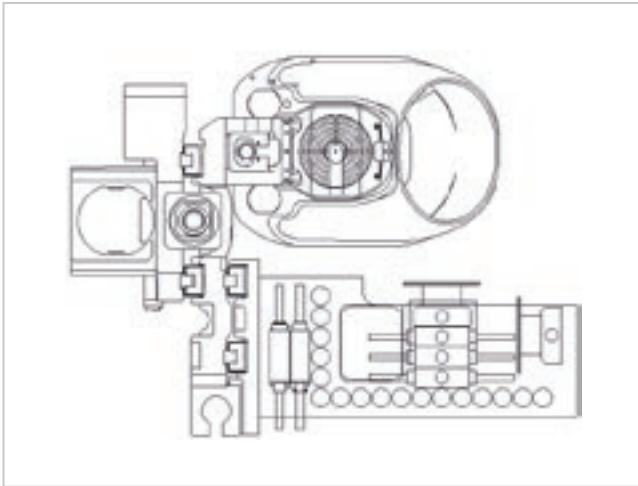

4-axis milling unit with power up to 19.2 kW.

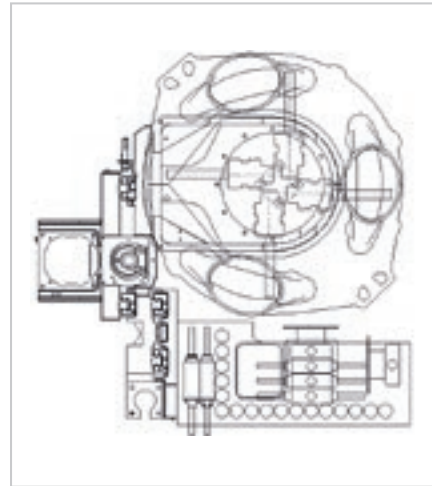

5-axis milling unit with power of 13 kW.



C-Torque axis for excellent speed and precision when managing the aggregates.

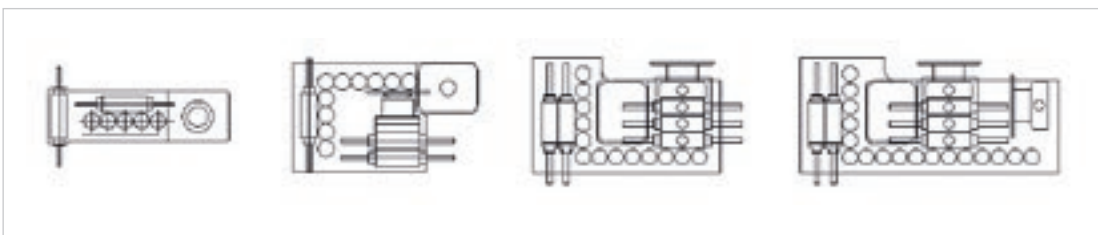

Available boring heads from 9 to 29 positions: BH9 - BH17 L - BH24 L - BH29 2L

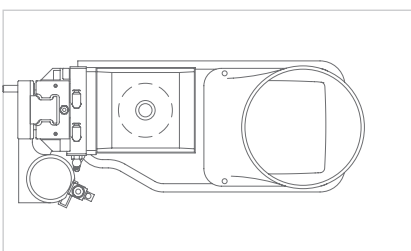

Vertical milling unit.
Motor power 7.2 kW



Vertical milling unit with right or left rotation, with manual tool change.

Used for light milling operations, machining operation start-up, or edge trimming/rounding of the edgebanding strip without having to make a tool change.

TECHNICAL SPECIFICATIONS

WORKING TABLE

		Z	Y	X	X pendulum	X pendulum with suspension (***)
Rover A Edge 1532	mm	245 (*) / 75 (**)	1550 (max loadable panel thickness 1560)	3140	1000	1415
Rover A Edge 1542	mm			4140	1500	1915
Rover A Edge 1556	mm			5540	2200	2615
Rover A Edge 1832	mm		1850 (max loadable panel thickness 1860)	3140	1000	1415
Rover A Edge 1842	mm			4140	1500	1915
Rover A Edge 1856	mm			5540	2200	2615

(*) With H29 vacuum modules, the max tool length is 160mm, including the HSK aggregate in the Revolver magazine.

(**) With edgebanding setting.

(***) The pendulum processing with suspension leaves the availability of an extra workable area; the loading operation is not allowed during the edgebanding operations on the opposite side. For routing and edge finishing operations the same limit can be selected in the program to choose a better productivity or better quality.



FULL BUMPER FOOT PRINT

Max speed 25 m/min

		X	Y	Area (m ²)	X + opt (*)	Y + opt (*)
Rover A Edge 1532	mm	7368	6000	44,2	7748	5550
Rover A Edge 1542	mm	8368		50,2	8748	
Rover A Edge 1556	mm	9768		58,6	10148	
Rover A Edge 1832	mm	7368	6150	45,3	7748	5700
Rover A Edge 1842	mm	8368		51,5	8748	
Rover A Edge 1856	mm	9768		60,1	10148	

(*) To install the machine against a back wall.

The technical specifications and drawings are non-binding. Some photos may show machines equipped with optional features. Biesse Spa reserves the right to carry out modifications without prior notice.

A weighted sound pressure level (LpA) during machining for operator workstation on vane-pump machine Lpa=79dB(A) Lwa=96dB(A) A-weighted sound-pressure level (LpA) for operator workstation and sound power level (LwA) during machining on cam-pump machine Lwa=83dB(A) Lwa=100dB(A) K measurement uncertainty dB(A) 4.

The measurement was carried out in compliance with UNI EN 848-3:2007, UNI EN ISO 3746: 2009 (sound power) and UNI EN ISO 11202: 2009 (sound pressure levels at workstation) during panel machining. The noise levels shown are emission levels and do not necessarily correspond to safe operation levels. Despite the fact that there is a relationship between emission and exposure levels, this may not be used in a reliable manner to establish whether further measures need to be taken. The factors determining the exposure level for the workforce include length of exposure, work environment characteristics, other sources of dust and noise, etc. i.e. the number of other adjoining machines and processes. At any rate, the above information will enable the operator to better evaluate dangers and risks.



OVERALL DIMENSIONS PHOTOCELS + BUMPER + NETS

Max. speed 60 m/min

		X	Y	Area (m ²)
Rover A Edge 1532	mm	7573	6336	48,0
Rover A Edge 1542	mm	8573		54,3
Rover A Edge 1556	mm	9973		63,2
Rover A Edge 1832	mm	7573		48,0
Rover A Edge 1842	mm	8573		54,3
Rover A Edge 1856	mm	9973		63,2

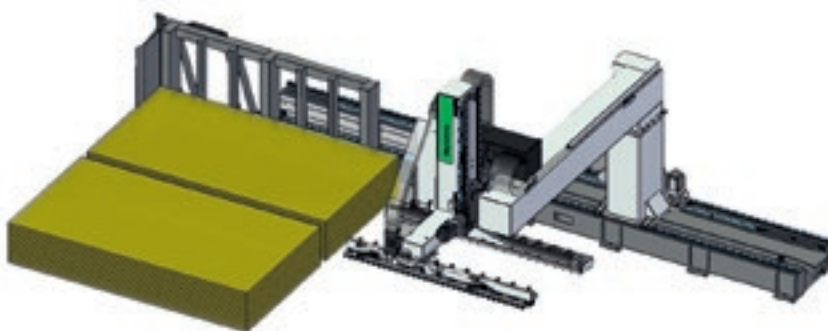

WORKING TABLE SYNCHRO

Length (min / max)	mm	400 / 3200 *
Width (min / max)	mm	200 / 2200 *
Thickness (min / max)	mm	8 / 150
Weight (1 panel / 2 panels)	Kg	150 / 75
Useful height of stack	mm	1000
Height of stack from ground (including 145 mm Europallet)	mm	1145

(*) The Min and Max values may vary in accordance with the configurations of Synchro and the Rover machining centre to which Synchro is linked.

HIGH-TECH BECOMES ACCESSIBLE AND INTUITIVE



B_SOLID IS A 3D CAD CAM SOFTWARE PROGRAM THAT SUPPORTS THE PERFORMANCE OF ANY MACHINING OPERATION THANKS TO VERTICAL MODULES DESIGNED FOR SPECIFIC MANUFACTURING PROCESSES.

- Planning in just a few clicks.
- Simulating machining operations to visualise the piece ahead of manufacturing and have some guidance for the planning phase.
- Virtual prototyping of the piece to avoid collisions and ensure optimal machine equipment.
- Machining operation simulation with a calculation of the execution time.



B_SOLID

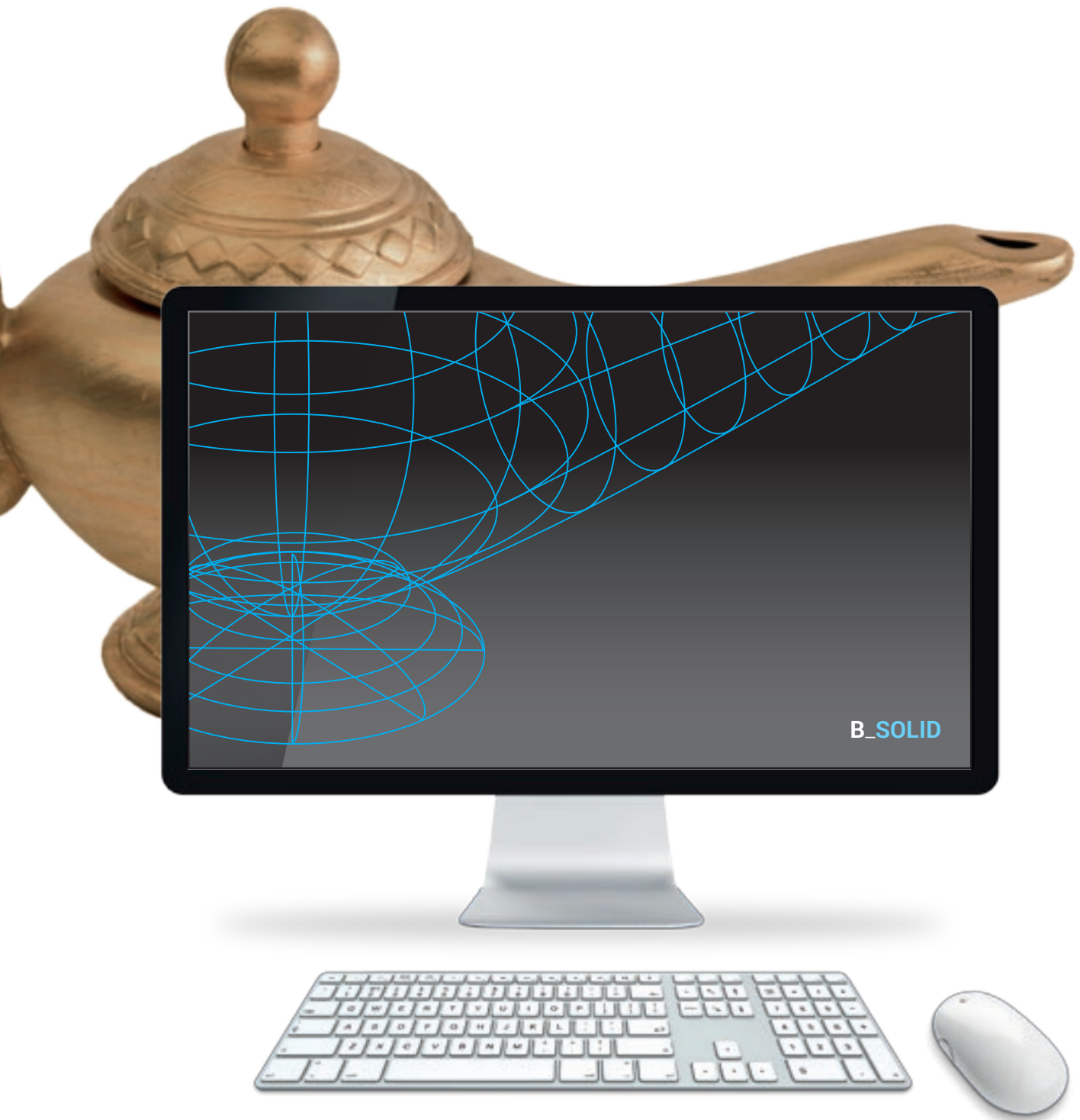

B_SOLID

SIMPLIFYING EDGE BANDING PROGRAMMING



B_EDGE IS AN ADDITIONAL MODULE INTEGRATED IN B_SUITE. MAKING FULL USE OF THE CAPACITIES OF THE SUITE, B_EDGE SIMPLIFIES THE PROGRAMMING OF THE EDGE BANDING PROCESS.

- Automatic generation of the edgebanding operation sequence.
- Easy to understand and operate.
- Simplified management of edgebanding strips and edgebanding devices

B_EDGE

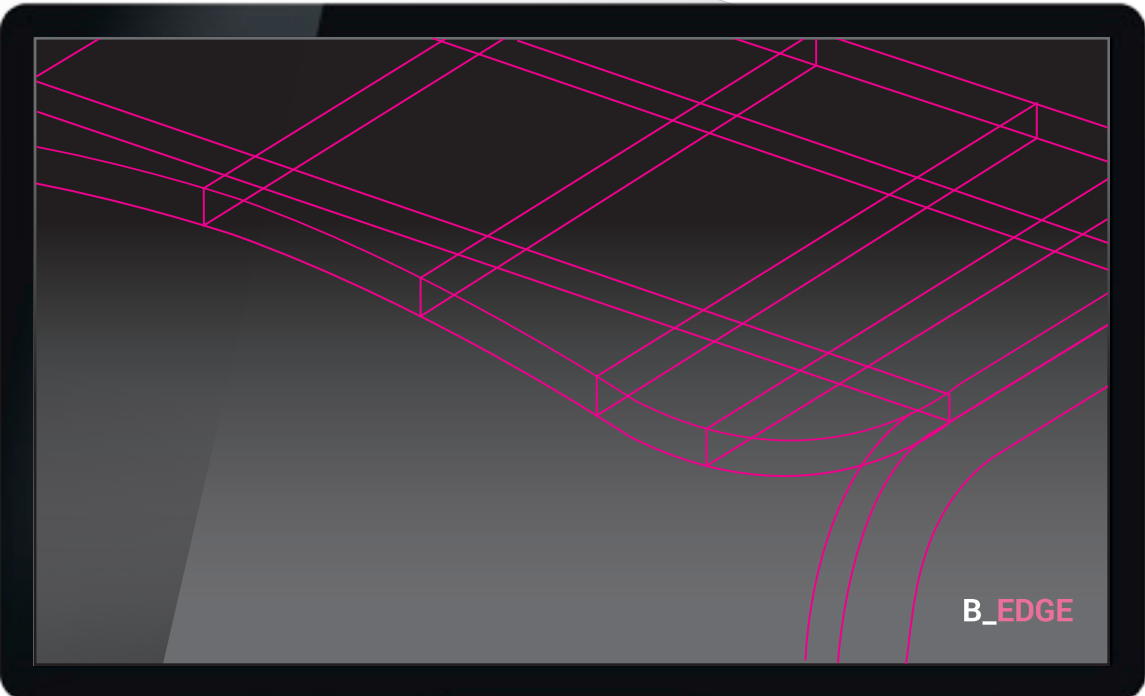

IDEAS TAKE FORM AND SHAPE



B_CABINET IS A UNIQUE SOLUTION FOR MANAGING FURNITURE PRODUCTION FROM THE 3D DESIGN PHASE TO PRODUCTION FLOW MONITORING.

IT'S NOW POSSIBLE TO PLAN THE DESIGN OF A SPACE AND QUICKLY PASS FROM CREATING THE SINGLE ELEMENTS TO GENERATING PHOTO-REALISTIC CATALOGUE IMAGES, FROM GENERATING TECHNICAL PRINTS TO PRODUCING REQUIREMENT REPORTS, AND ALL IN ONE SINGLE ENVIRONMENT.

B_CABINET FOUR (SUPPLEMENTARY MODULE) MAKES IT EASY TO MANAGE ALL THE WORK PHASES (CUTTING, MILLING, BORING, EDGE BANDING, ASSEMBLY, PACKAGING), JUST WITH A CLICK.

B_CABINET FOUR INCLUDES AN ENVIRONMENT DEDICATED TO THE REAL TIME MONITORING OF THE PROGRESS OF THE PRODUCTION PHASES. THAT MEANS COMPLETE CONTROL OF THE ORDER STATUS, STEP BY STEP, THANKS TO CHARTS AND 3D IMAGES.

B_CABINET



SOPHIA

GREATER VALUE FROM MACHINES



SOPHIA is the IoT platform created by Biesse in collaboration with Accenture which enables its customers to access a wide range of services to streamline and rationalise their work management processes.

It allows alerts and indicators to be sent to the customer in real time, in relation to production, the machines used and the type of process carried out. These are detailed instructions for more efficient use of the machine.

□ **10% CUT IN COSTS**

□ **50% REDUCTION
IN MACHINE DOWNTIME**

□ **10% INCREASE
IN PRODUCTIVITY**

□ **80% REDUCTION IN PROBLEM
DIAGNOSTICS TIME**

**SOPHIA TAKES THE INTERACTION BETWEEN
CUSTOMER AND SERVICE TO A HIGHER LEVEL.**

iOT
SOPHIA

IoT - SOPHIA provides a comprehensive overview of the specific machine performance features, with remote diagnostics, machine stoppage analysis and fault prevention. The service includes a continuous connection with the control centre, the option of calling for assistance from within the customer app (such calls are managed as priorities), and an inspection visit for diagnostic and performance testing within the warranty period. Through SOPHIA, the customer receives priority technical assistance.

PARTS
SOPHIA

PARTS SOPHIA is the easy new, user-friendly and personalised tool for ordering Biesse spare parts. The portal offers customers, dealers and branches the chance to navigate within a personalised account, consult the constantly updated documentation of the machines purchased, and create a spare parts purchase basket indicating the real time availability in the warehouse and the relative price list. In addition, the progress of the order can be monitored at all times.

 **BIESSE**

in collaboration with  **accenture**

SERVICE & PARTS

Direct, seamless co-ordination of service requests between Service and Parts. Support for Key Customers by dedicated Biesse personnel, either in-house and/or at the customer's site.

BIESSE SERVICE

- ✔ Machine and system installation and commissioning.
- ✔ Training centre dedicated to Biesse Field engineers, subsidiary and dealer personnel; client training directly at client's site.
- ✔ Overhaul, upgrade, repair and maintenance.
- ✔ Remote troubleshooting and diagnostics.
- ✔ Software upgrade.

500

Biesse Field engineers in Italy and worldwide.

50

Biesse engineers manning a Teleservice Centre.

550

certified Dealer engineers.

120

training courses in a variety of languages every year.

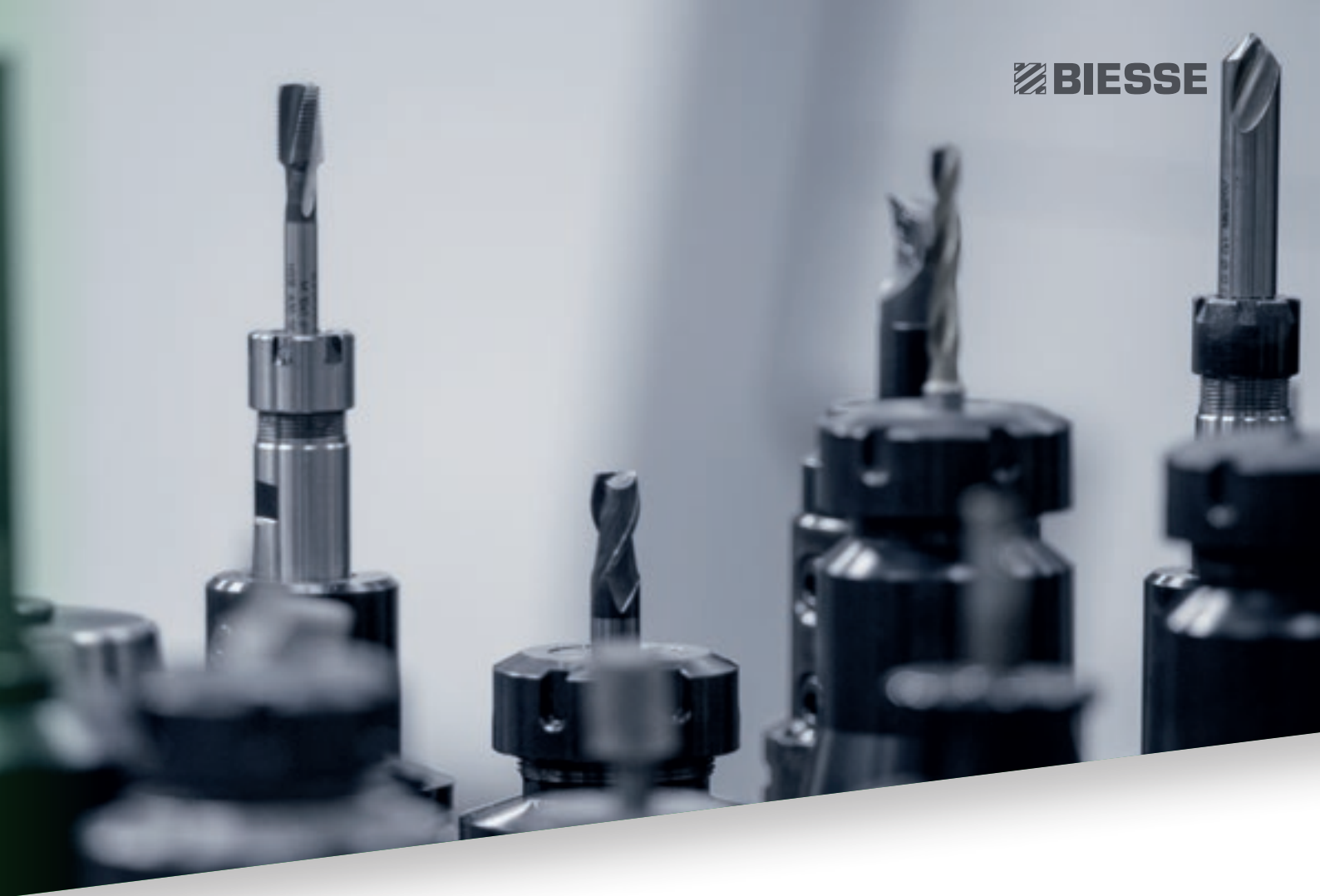
A close-up photograph of several metal drill bits and tool components, arranged in a row. The bits are of different sizes and designs, some with standard double-flute and others with more complex, multi-fluted designs. They are set against a blurred background, highlighting their metallic texture and sharp edges.

The Biesse Group promotes, nurtures and develops close and constructive relationships with customers in order to better understand their needs and improve its products and after-sales service through two dedicated areas: Biesse Service and Biesse Parts. With its global network and highly specialized team, it offers technical service and machine/component spares anywhere in the world on-site and 24/7 on-line.

BIESSE PARTS

- ✔ Original Biesse spares and spare kits customized for different machine models.
- ✔ Spare part identification support.
- ✔ Offices of DHL, UPS and GLS logistics partners located within the Biesse spare part warehouse, with multiple daily pick-ups.
- ✔ Order fulfillment time optimized thanks to a global distribution network with de-localized, automated warehouses.

92%
of downtime machine orders fulfilled
within 24 hours.

96%
of orders delivered in full on time.

100
spare part staff in Italy and worldwide.

500
orders processed every day.

MADE WITH BIESSE

THE BIESSE GROUP'S TECHNOLOGY SUPPORTS THE MANUFACTURING EFFICIENCY OF THE WORLD'S LARGEST FURNITURE MANUFACTURERS

"We were looking for a solution that would be so innovative that it would satisfy all our needs at the same time," states the manufacturing manager of one of the world's largest furniture manufacturers.

"Most of our production was already made using numerical control tools, but now everything that we produce is made with these technologies. This is why it was necessary to increase our production capacity. Biesse offered a solution that we liked very

much, a veritable range of processing centres and automatic magazines. Innovative, fascinating and decidedly powerful. With Biesse we defined a "turnkey" solution to be planned, built, tested, installed, inspected and commissioned within a precisely defined schedule".

Source: excerpt from an interview to the manufacturing manager of one of the world's largest furniture manufacturers.

LIVE THE EXPERIENCE

BIESSEGROUP.COM

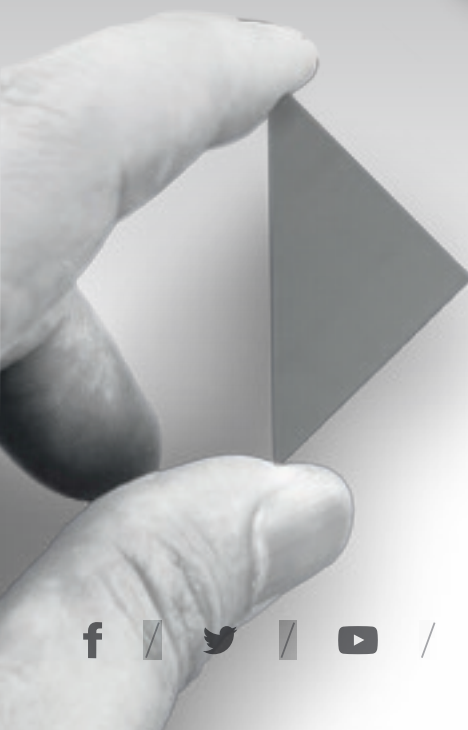

Interconnected technologies and advanced services that maximise efficiency and productivity, generating new skills to serve better our customer.

LIVE THE BIESSE GROUP EXPERIENCE AT OUR CAMPUSES ACROSS THE WORLD.



