

SEL CO WNA 6

CUT TO SIZE
ANGULAR PLANTS

 **BIESSE**

 YEARS
 **BIESSEGROUP**

REDUCED WORKING DIMENSIONS AND MAXIMUM PERFORMANCE



THE MARKET DEMANDS

a change in manufacturing processes, enabling companies to **accept the largest possible number of orders**. This is coupled with the need to maintain high quality standards whilst offering product customisation with **quick and defined delivery times**, as well as responding to the needs of highly automated enterprises..

BIESSE MEETS

these requirements with technological solutions that highlight and support technical expertise as well as process and material knowledge. **SELCO WNA 6** is a range of cutting systems offering two fully independent cutting lines with automated loading that respond to the requirements of the furniture and semi-finished product industries. **Selco WNA 6** is an innovative solution that is ideally suited to small and medium-sized companies who want to automate their production processes.

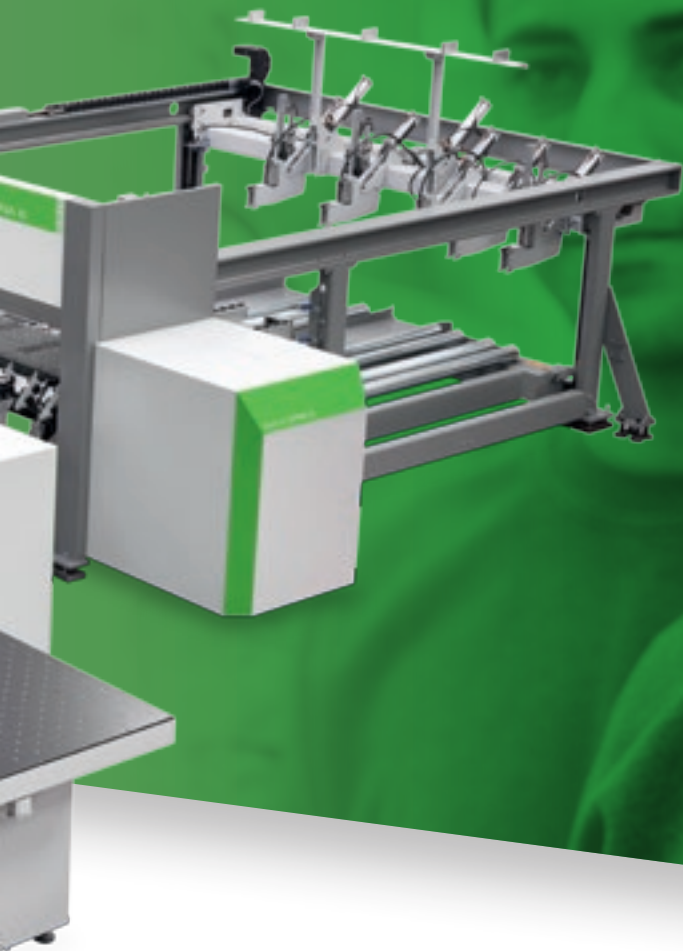

SELCO WNA 6

- ✔ HIGH CUTTING QUALITY
- ✔ TOP-QUALITY FINISHED PRODUCT
- ✔ EXCELLENT PRECISION WHEN MACHINING LARGE PANELS
- ✔ QUICK SET-UP TIMES
- ✔ MAXIMUM PRODUCTIVITY ON ANY PATTERN
- ✔ TOTAL INTEGRATION WITH AUTOMATED LINE SYSTEMS.

OPTIMAL CUTTING QUALITY

Solid base structure which ensures perfect stability, maximum quality and long term reliability of machining operations.



The optimal balancing and weight distribution on the two guides guarantees the total absence of vibrations and perfectly straight cutting action.

Excellent product quality, thanks to the air-cushioned working surface, which protects delicate materials. In addition, this characteristic ensures the surface next to the blade is always kept clean.

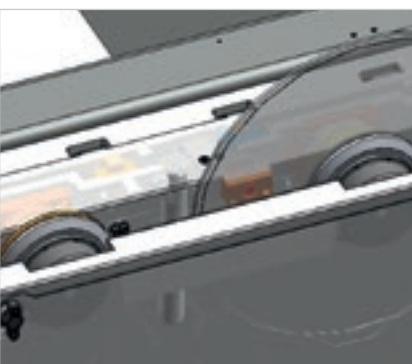
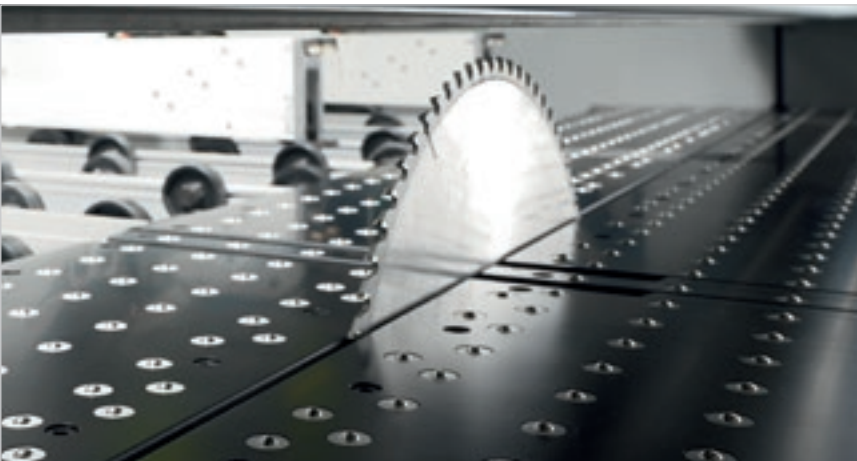

The anti-slide device controls the position and the number of revolutions of the blade, intervening to adjust the advance speed. **Maximum cutting quality, a longer blade lifespan, and reduced maintenance costs.**

Motorised vertical movement of the blade ensures fast and **precise cutting height adjustment.**

TOP-QUALITY FINISHED PRODUCT



The double presser, with a double, independent structure, enables the application of consistent, controlled pressure to the stack of panels to be cut, thanks to the continuous gripper action, which also creates an actual sealed chamber for trim cuts and an efficient vacuum for the removal of dust.



Cutting line closure system, to prevent the longitudinal trim cuts from falling into the machine and fouling the blade path.



The stacks of strips are selectively transferred to the cross cut area according to the cutting cycle worked out by the Numeric Control.



Longitudinal double-edge trims are disposed of by means of a dedicated and fully automated trapdoor with independent rollers.

MACHINING OPERATION PRECISION

The sturdy pushing carriage positions the panels quickly and accurately, thanks to its brushless motor. The slide surface below the pushing device is fitted with independent rollers to avoid marking delicate surfaced panels.

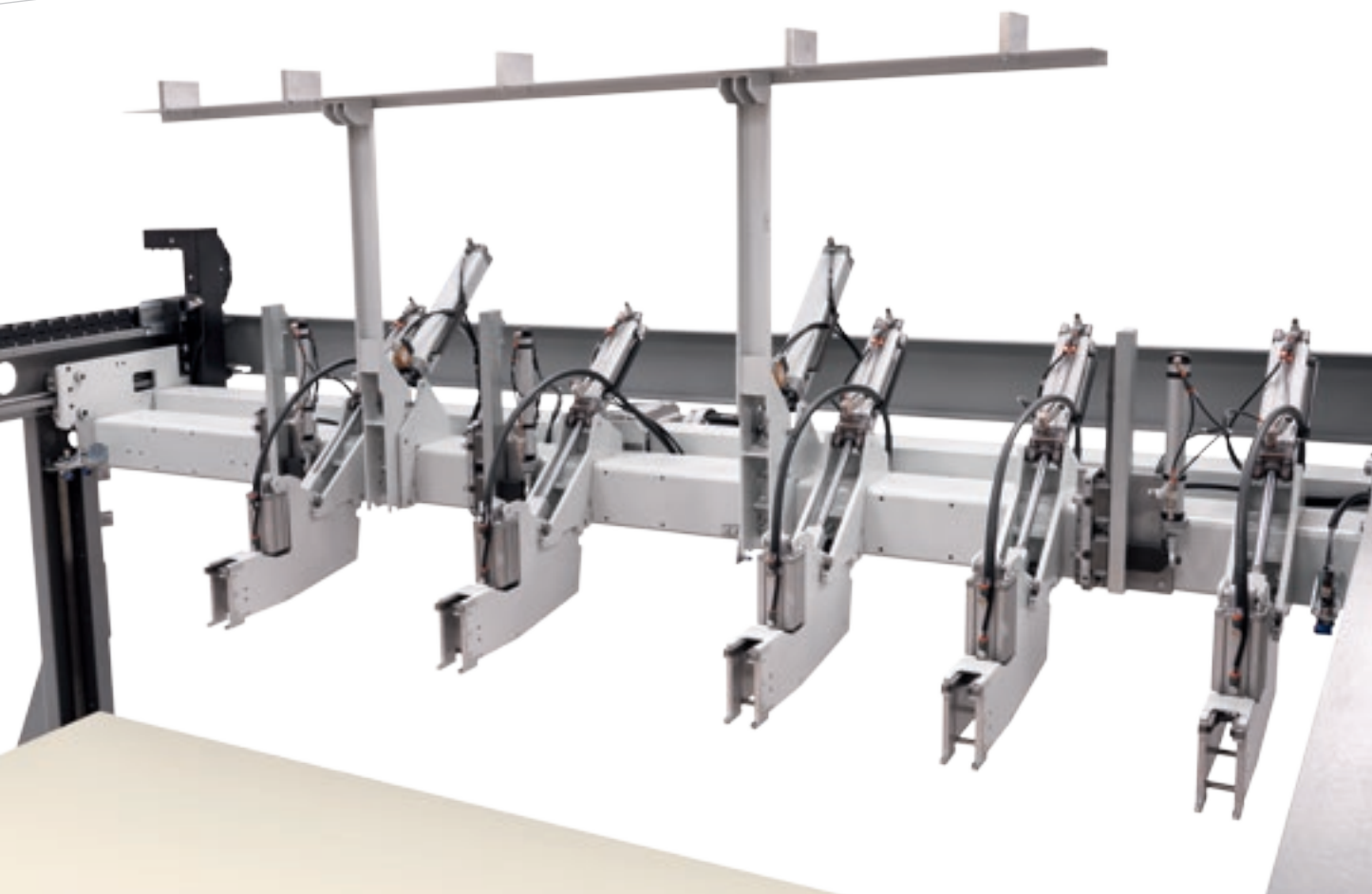

Powerful front aligners align the book of panels against the pushing device collets.

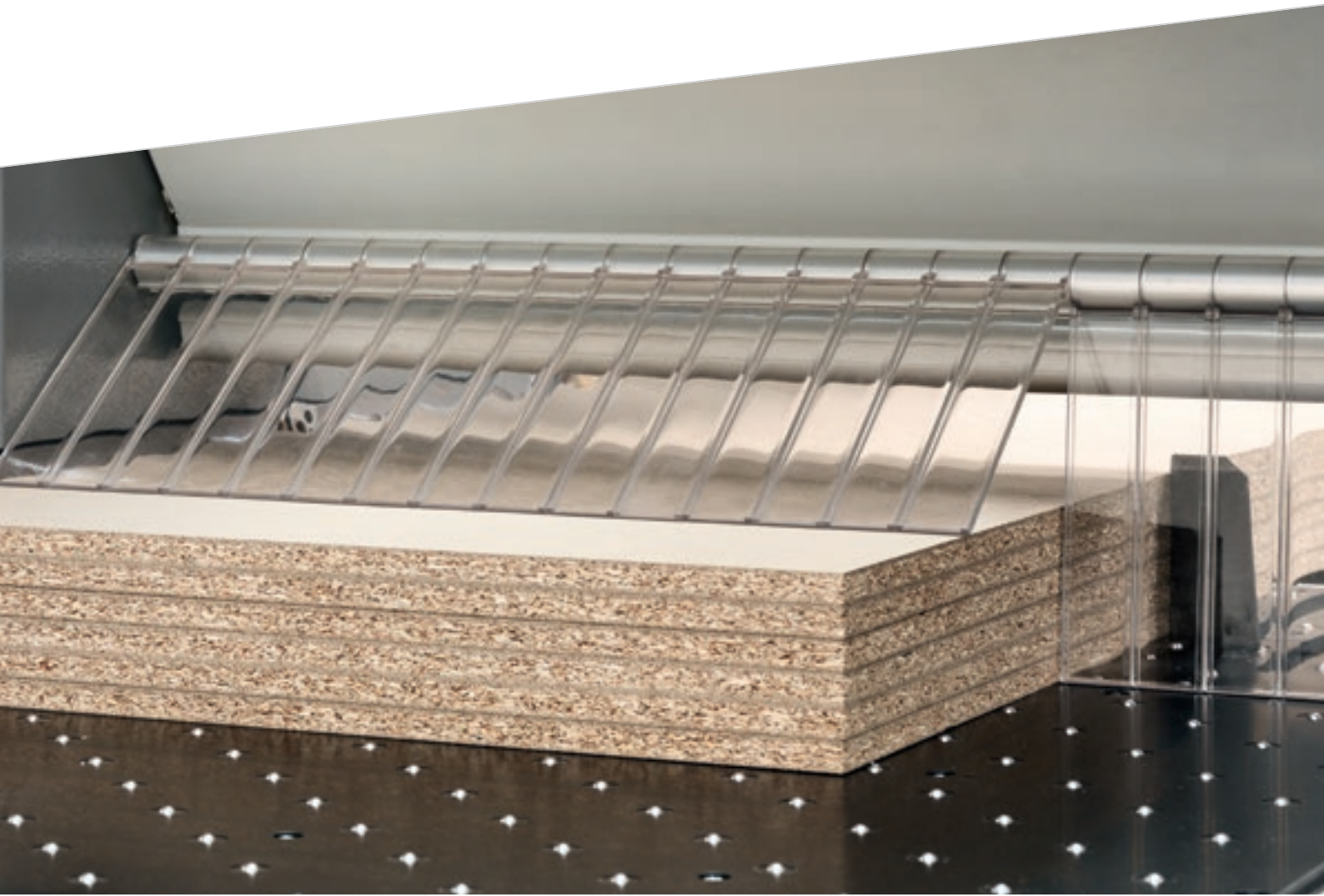

Side alignment stop integrated in the transversal blade carriage. Its features enable the perfect alignment of even the thinnest and/or most flexible panels, reducing cycle time to a minimum

A SOLUTION TO ANY REQUIREMENT



Thin panels can be loaded from the lifting table, using independent floating pushing points that are electronically controlled. A specific logic together with the front pop-up stops prevent the risk of mis-feeding (by means of attrition) those panels that don't belong to the book being fed.

QUICK SET-UP TIMES

Patented systems for quick and easy regulation.



The “**Quick change**” system is the quickest, most ergonomic and safest device for changing blades without using tools.

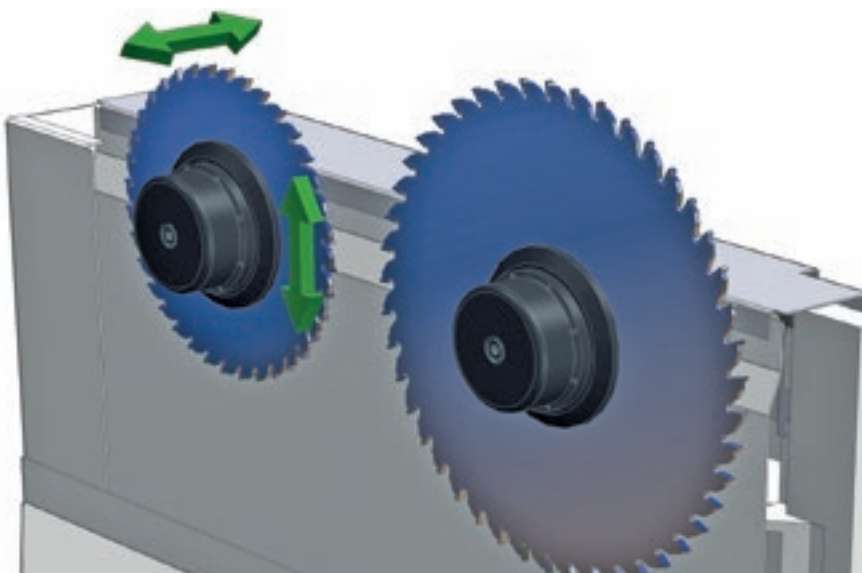

Fast, accurate setting of the scoring and main blades, using the Digiset system.

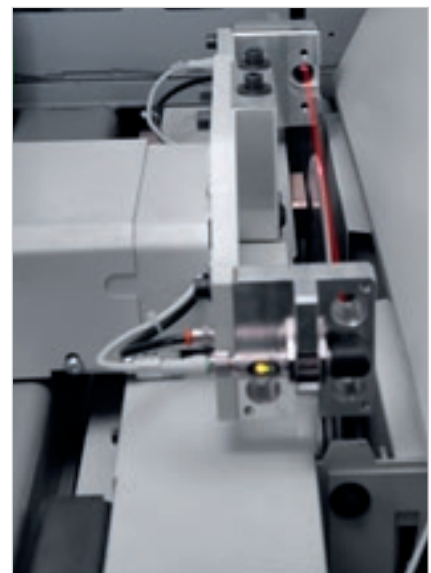

Automatic scoring blade alignment. The patented system automatically aligns the scoring blade in seconds. Supports the reduction of set-up times, test cutting and errors, increasing efficiency and reducing sharpening costs.

MAXIMUM PRODUCTIVE EFFICIENCY

R³ SYSTEM for automatic execution of third phase cuts. It avoids manual operator intervention increasing the overall plant productivity.

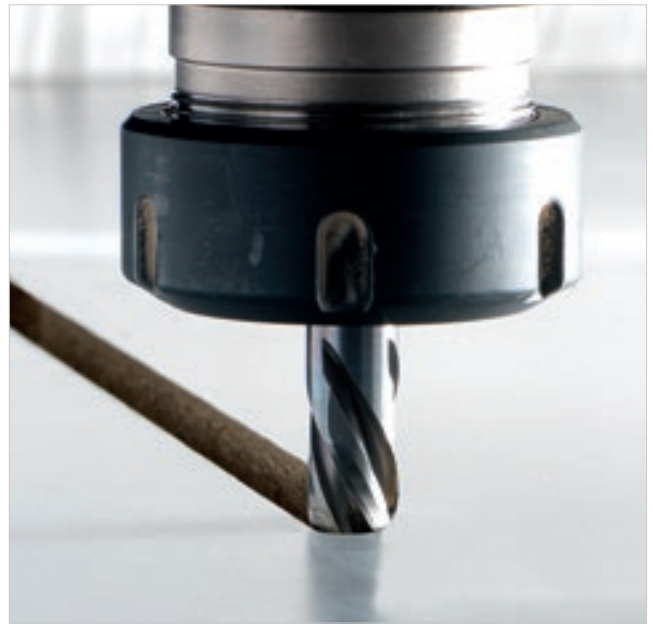

The two cutting stations can execute cutting patterns completely independently, thanks to the presence of an intermediate zone that can accommodate a whole panel. Both areas are fully covered in independent rollers to preserve the panels' surface.



MULTI PUS HER

SIMULTANEOUS MULTIPLE ACTION

Significant reduction of processing times thanks to the possibility of combining the grippers with any type of cutting patterns in a single cycle.

System for performing simultaneous transverse cuts due to the two fully independent pushing devices and two completely independent motorless grippers. This mechanism changes distance between the two pushing devices and therefore their working field. This enables the processing of panels up to 4500 x 2200 mm.

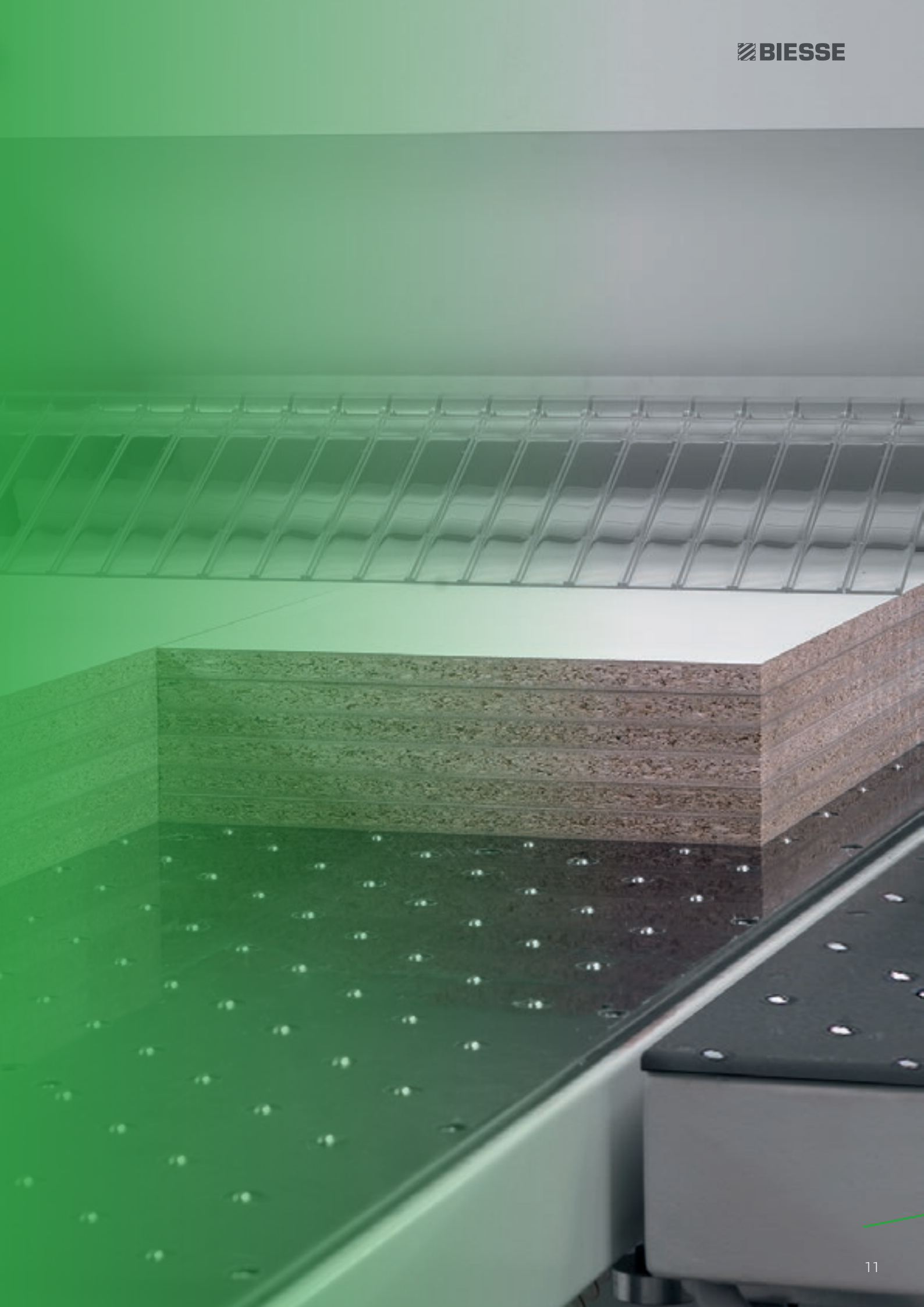

MAXIMUM PRODUCTIVITY ON ANY PATTERN

Multipusher 2.2



Device for simultaneous execution of staggered cross cuts, made with two completely separate pushers. Each pusher can choose to select one idle slave gripper (not powered) completely independently, based on the strips width to be cut.

Based on the cutting patterns, the gripper on rollers can connect with two pushing devices.

Differentiated cross-cut, also for narrow strips.

Multipusher 2.4

Differentiated cross-cut,
also for narrow strips.

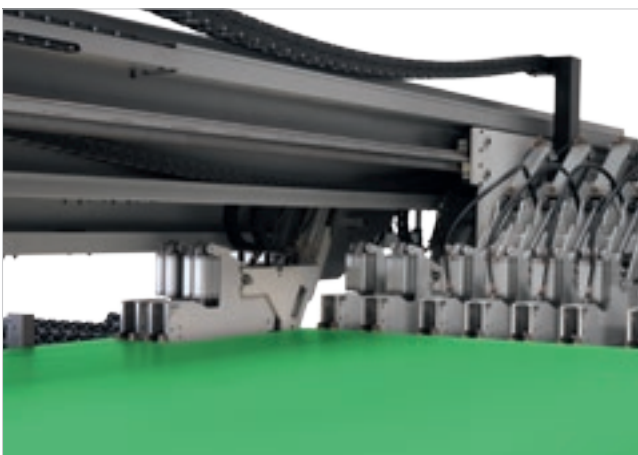
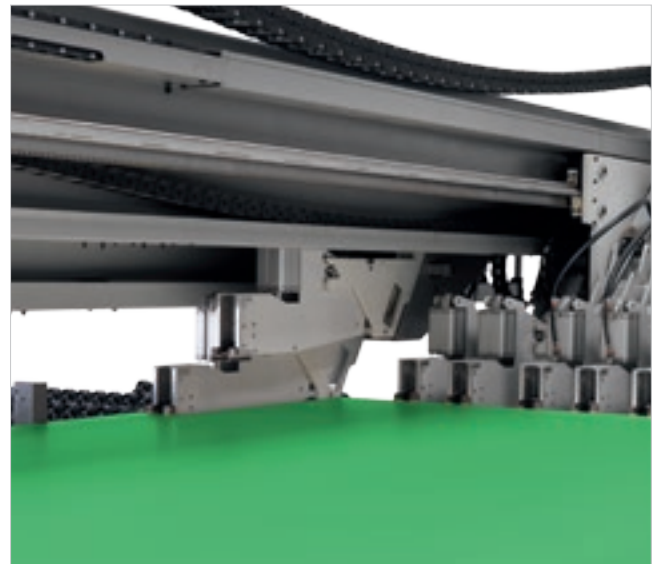
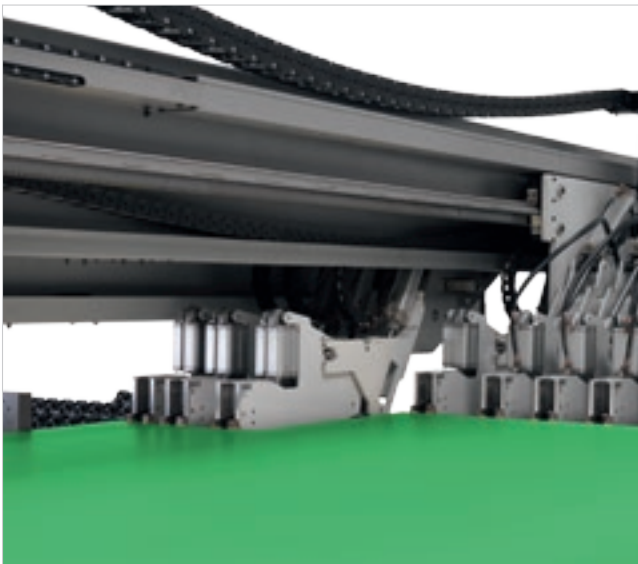

Device for simultaneous execution of staggered cross cuts, made with two completely separate pushers. Each pusher can choose to select two idle slave grippers (not powered) completely independently, based on the strips width to be cut. This unique solution allows to modulate the width of the two pushers and their working area.

Based on the cutting patterns, the two grippers on rollers can connect with two pushing devices, both individually or together.

Differentiated cross-cut, also for narrow strips.

REDUCED PANEL LOADING AND DOWNLOADING TIMES

Special solutions for handling stacks and feeding and unloading panels available upon request.



Infeed conveyors with free-running or powered rollers allow the loading and side or rear unloading of panel stacks.



Double-level infeed conveyor. Thanks to the reduced footprint, which utilises height, the double-level infeed conveyor enables the optimisation of space and is perfectly suited to production sites that cannot accommodate two conveyors side by side.



The lift table consists of a strong frame which is equipped with a special structure to load the pack of panels directly by forklift.



Loading and unloading optimised for large volumes.



The (patented) rotating station rotates the stack of panels, maintaining the alignment with the point of reference both before and after rotation. Panel clamping devices avoid the misalignment of the stack during the rotation phase.



Front aligners to align the boards in the width directly on the turn station unit.



Panel clamping devices avoid the misalignment of the stack during the rotation phase

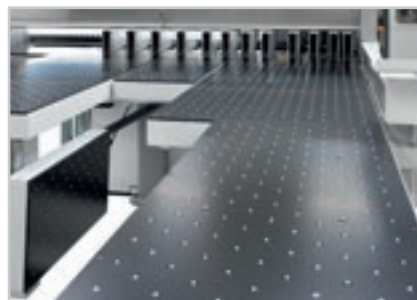

Wide range of configuration options to facilitate panel unloading.



BIESSE SYSTEMS EMMS

COMPETITIVE CUSTOMISATION

Biesse Systems is a team of highly trained engineers for large scale production processes. Biesse Systems offers integrated cells and systems that are capable of maximising customer competitiveness by combining mass production techniques with a high degree of customisation to meet customers' exact requirements.

Made-to-measure turnkey factories, plus the integration of Biesse Group solutions with complementary software and machinery, with over 1000 systems installed worldwide.

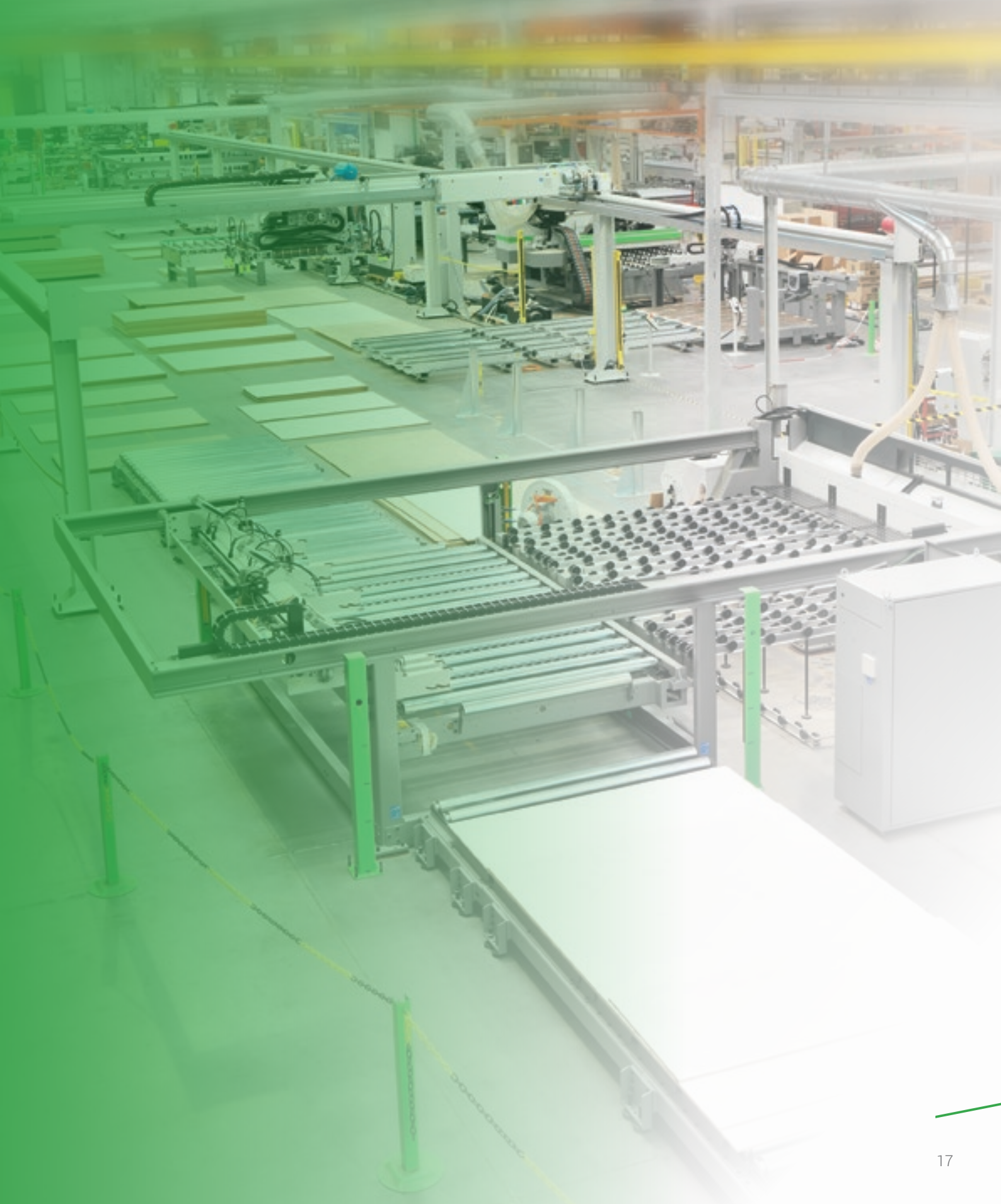

EASY TO USE, WITH OPTIMISED MACHINING OPERATIONS

The OSI (Open Selco Interface) numerical control guarantees the management of the execution of cutting patterns, and optimizes all movements relative to controlled axis (i.e. Pusher and Saw Carriage, pressure beam, blade height). It ensures the blade protrudes from the book to the correct degree during sectioning, and calculates the most suitable cutting speed on the basis of the book height and trim cut width. It helps ensure the best cutting quality at all times.

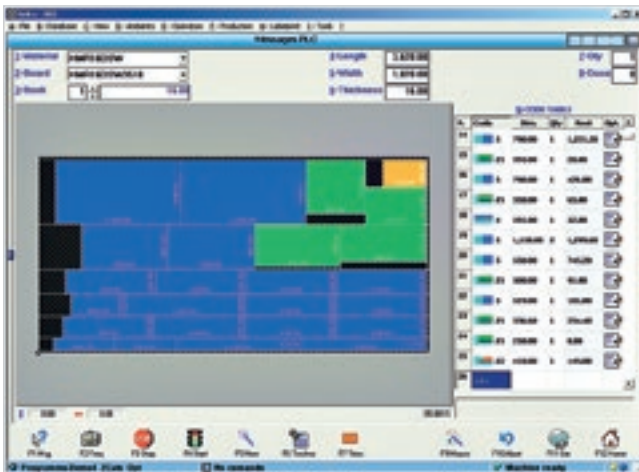

Easy cutting pattern programming.



Graphic simulation in real time, with messages and information for the operator.

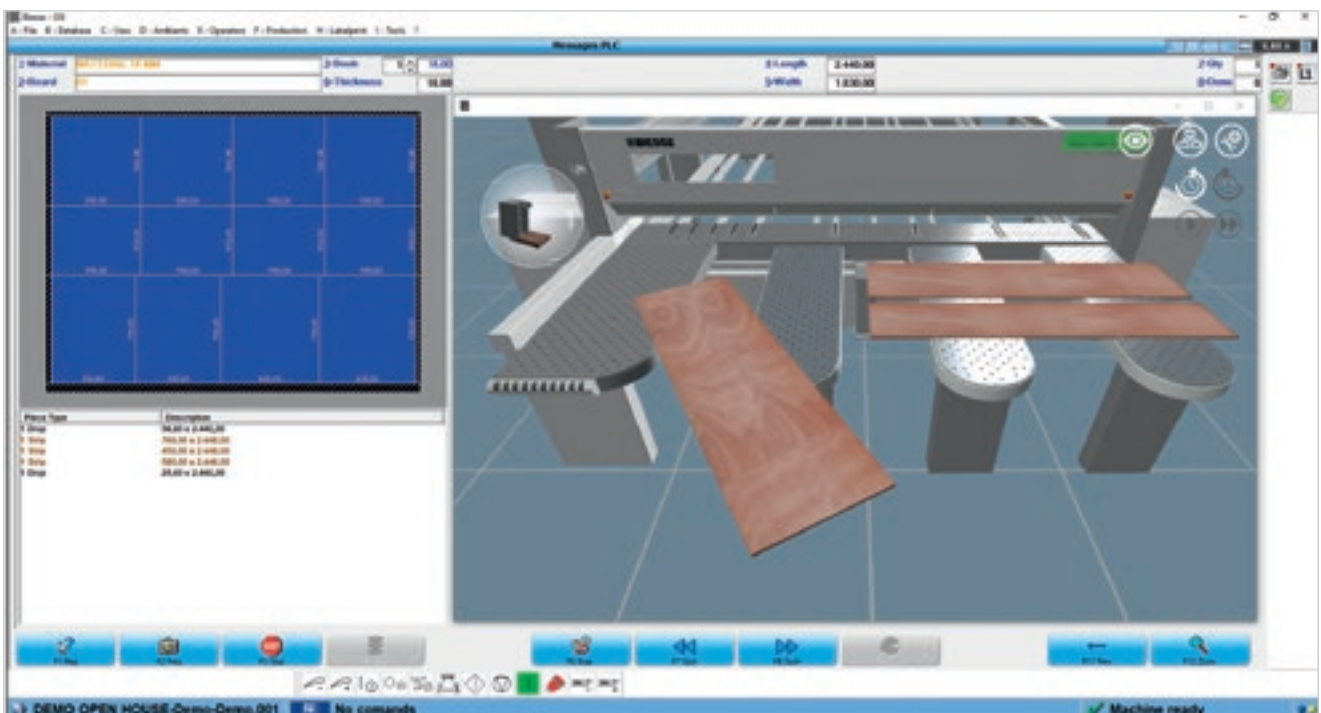



Interactive program for the quick, easy execution of cuts and grooves, even on recycled panels.

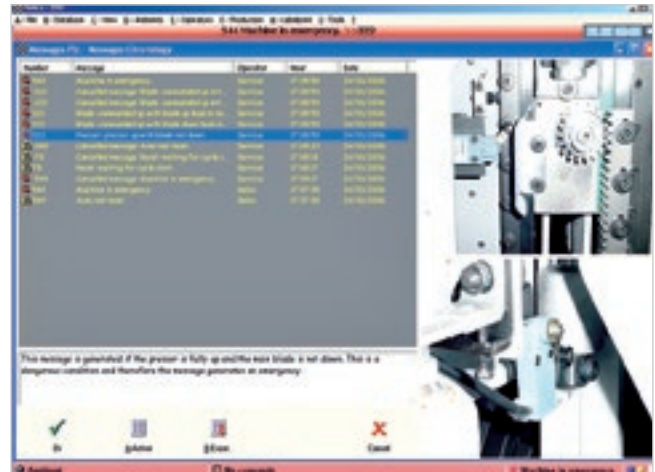

An effective diagnosis and troubleshooting program provides complete information (photos and text) to ensure that any problems are quickly resolved.

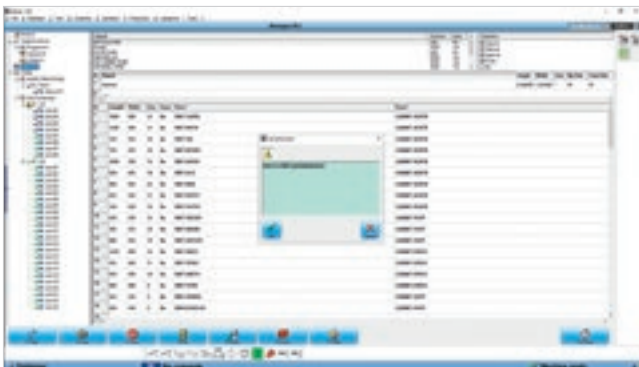

Quick Opti
Simple, intuitive software for optimising the cutting patterns directly on the machine.*

Labelling.
A special software creates individual labels and prints them in real time, on the machine. The information available can also be printed in bar code form.



CAN BE FULLY INTEGRATED WITH AUTOMATED LINE SYSTEMS

Biesse can provide bespoke solutions which are tailored to meet your specific productivity, automation and space requirements.



Winstore

Automated solution for cutting cells loading.



Lifter

Bridge unloader for cutting cells.



Cutting system with automated unloading for large batches.

TECHNICAL SPECIFICATIONS

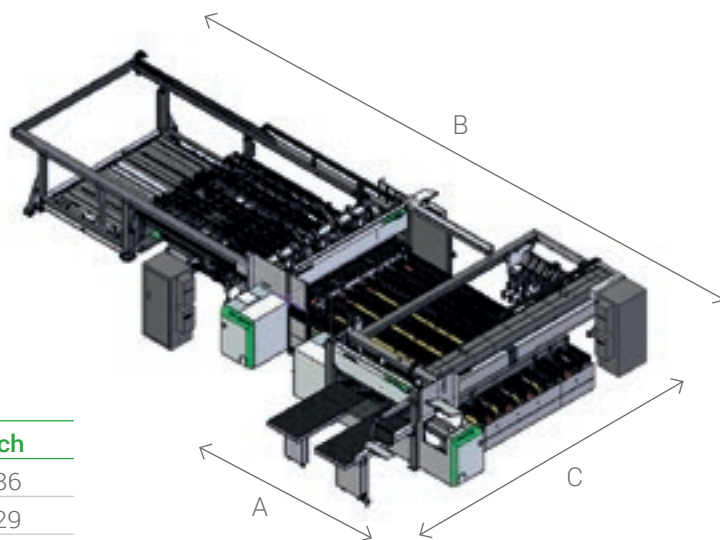

SELCO WNA 630 - 650

	3200 X 2200		4500 X 2200	
	mm	inch	mm	inch
A	4720	186	4720	186
B	10900	429	10900	429
C	7920	312	9250	364

SELCO WNAR 630 - 650

	3200 X 2200		4500 X 2200	
	mm	inch	mm	inch
A	4720	186	4720	186
B	13900	547	15400	606
C	7920	312	9250	364

		610	630	650
Maximum base protrusion	mm / inch	95 / 3,7	108 / 4,2	123 / 5
Main blade motor	kW	15	18,5	18,5
Engraver blade motor	kW		2,2	
Blade carriage transfer			brushless	
Blade carriage speed	m/min - ft/min		1 - 140 / 3,2 - 459	
Pushing device transfer			brushless	
Longitudinal pushing device speed	m/min - ft/min		90 / 295	
Transversal pushing device speed	m/min - ft/min		135 / 423	

The technical specifications and drawings are non-binding. Some photos may show machines equipped with optional features. Biesse Spa reserves the right to carry out modifications without prior notice.

A-weighted surface sound pressure level (L_{pfA}) during machining for operator workstation L_{pa}=83dB(A) L_{wa}=106dB(A) A-weighted sound-pressure level (L_{pA}) for operator workstation and sound power level (L_{wA}) during machining L_{wa}=83dB(A) L_{wa}=106dB(A) K measurement uncertainty dB(A) 4.

The measurement was carried out in compliance with UNI EN 848-3:2007, UNI EN ISO 3746: 2009 (sound power) and UNI EN ISO 11202: 2009 (sound pressure levels at workstation) during panel machining. The noise levels shown are emission levels and do not necessarily correspond to safe operation levels. Despite the fact that there is a relationship between emission and exposure levels, this may not be used in a reliable manner to establish whether further measures need to be taken. The factors determining the exposure level for the workforce include length of exposure, work environment characteristics, other sources of dust and noise, etc. i.e. the number of other adjoining machines and processes. At any rate, the above information will enable the operator to better evaluate dangers and risks.

SOFTWARE FOR THE SMART, ASSISTED MANAGEMENT OF CUTTING PATTERNS



OPTIPLANNING IS THE SOFTWARE FOR OPTIMISING CUTTING PATTERNS, DEVELOPED ENTIRELY BY BIESSE. BASED ON THE LIST OF PIECES TO BE PRODUCED AND THE PANELS AVAILABLE, IT CAN CALCULATE THE BEST SOLUTION TO MINIMISE MATERIAL CONSUMPTION, SECTIONING TIMES AND PRODUCTION COSTS.



- Simple, user-friendly interface.
- Excellent reliability of the calculation algorithms for production batches in small and large companies.
- Automatic import of the cutting list generated by the software for the design of furniture items and/or ERP management systems.

OPTIPLANNING



SOPHIA

GREATER VALUE FROM MACHINES

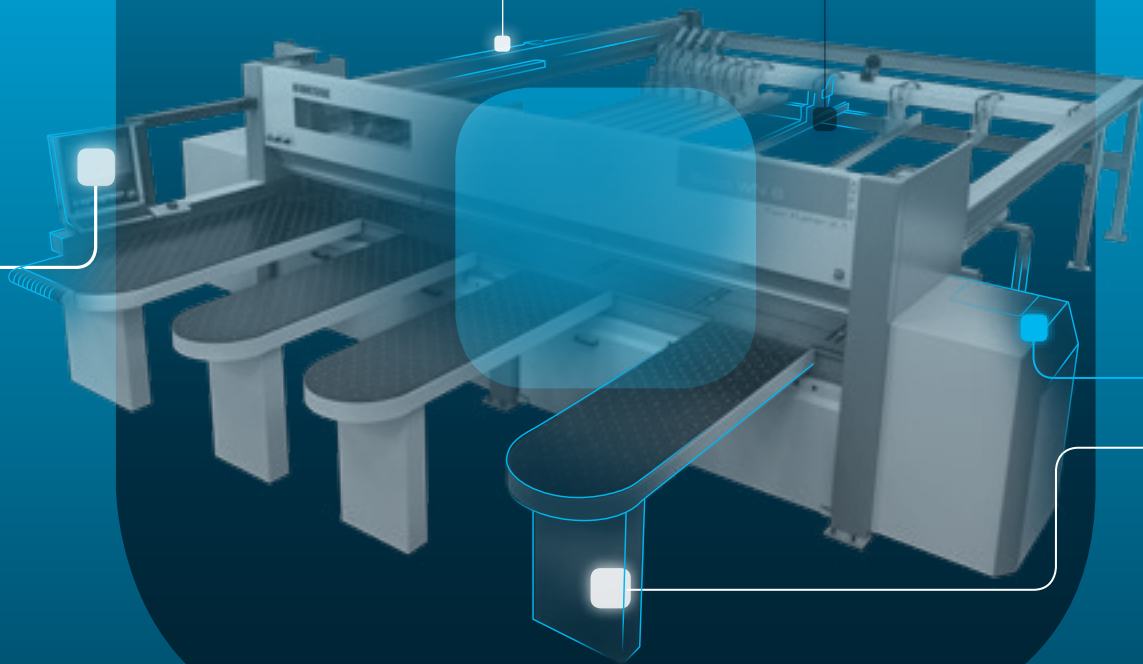

SOPHIA is the IoT platform created by Biesse in collaboration with Accenture which enables its customers to access a wide range of services to streamline and rationalise their work management processes.

It allows alerts and indicators to be sent to the customer in real time, in relation to production, the machines used and the type of process carried out. These are detailed instructions for more efficient use of the machine.

□ **10% CUT IN COSTS**

□ **50% REDUCTION
IN MACHINE DOWNTIME**

□ **10% INCREASE
IN PRODUCTIVITY**

□ **80% REDUCTION IN PROBLEM
DIAGNOSTICS TIME**

**SOPHIA TAKES THE INTERACTION BETWEEN
CUSTOMER AND SERVICE TO A HIGHER LEVEL.**

iOT
SOPHIA

IoT - SOPHIA provides a comprehensive overview of the specific machine performance features, with remote diagnostics, machine stoppage analysis and fault prevention. The service includes a continuous connection with the control centre, the option of calling for assistance from within the customer app (such calls are managed as priorities), and an inspection visit for diagnostic and performance testing within the warranty period. Through SOPHIA, the customer receives priority technical assistance.

PARTS
SOPHIA

PARTS SOPHIA is the easy new, user-friendly and personalised tool for ordering Biesse spare parts. The portal offers customers, dealers and branches the chance to navigate within a personalised account, consult the constantly updated documentation of the machines purchased, and create a spare parts purchase basket indicating the real time availability in the warehouse and the relative price list. In addition, the progress of the order can be monitored at all times.

 **BIESSE**

in collaboration with  **accenture**

SERVICE & PARTS

Direct, seamless co-ordination of service requests between Service and Parts. Support for Key Customers by dedicated Biesse personnel, either in-house and/or at the customer's site.

BIESSE SERVICE

- ✔ Machine and system installation and commissioning.
- ✔ Training centre dedicated to Biesse Field engineers, subsidiary and dealer personnel; client training directly at client's site.
- ✔ Overhaul, upgrade, repair and maintenance.
- ✔ Remote troubleshooting and diagnostics.
- ✔ Software upgrade.

500

Biesse Field engineers in Italy and worldwide.

50

Biesse engineers manning a Teleservice Centre.

550

certified Dealer engineers.

120

training courses in a variety of languages every year.

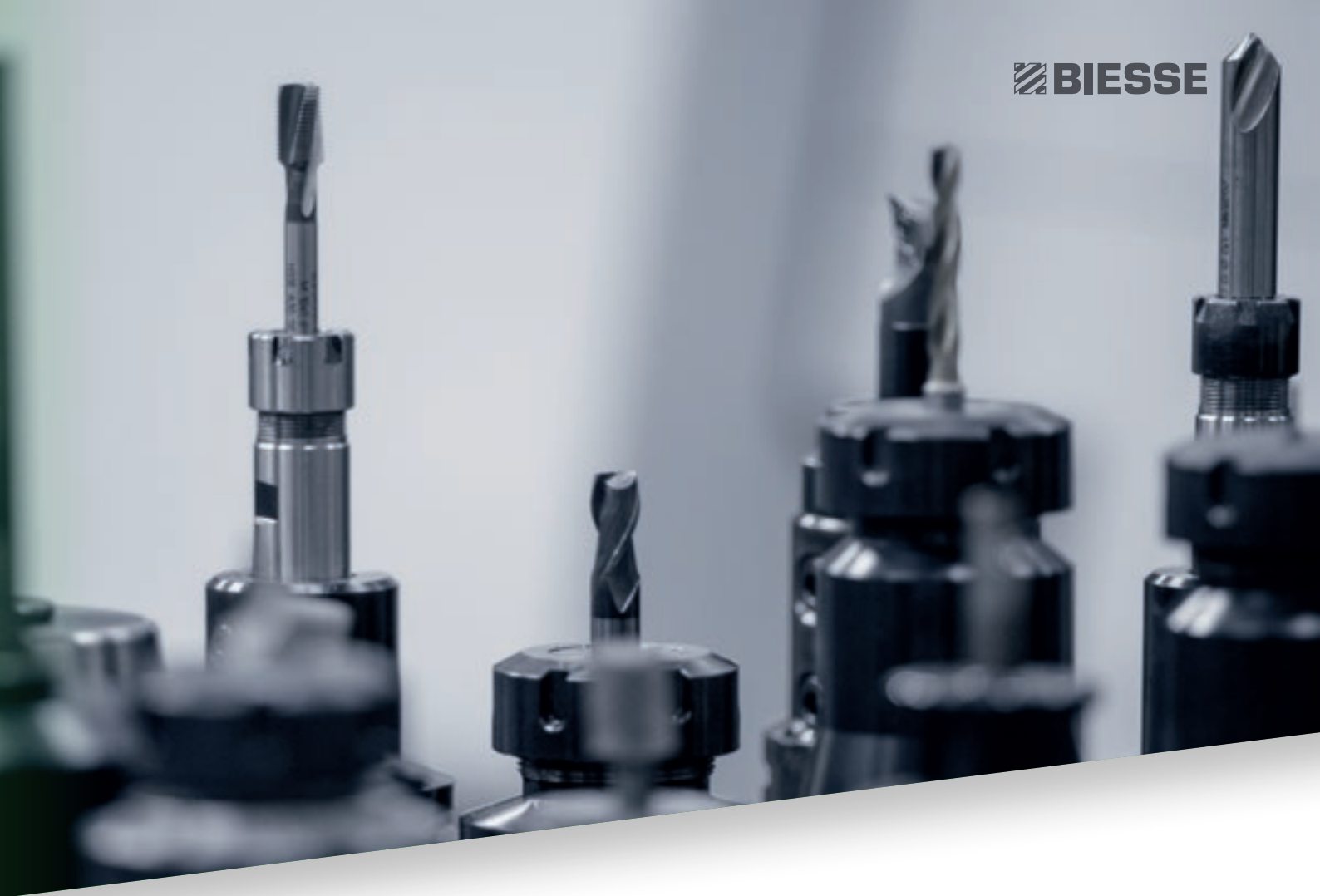
A close-up photograph of several metal drill bits and tool components, arranged in a row. The focus is sharp on the central bit, while the others are slightly blurred. The background is a soft, out-of-focus grey.

The Biesse Group promotes, nurtures and develops close and constructive relationships with customers in order to better understand their needs and improve its products and after-sales service through two dedicated areas: Biesse Service and Biesse Parts. With its global network and highly specialized team, it offers technical service and machine/component spares anywhere in the world on-site and 24/7 on-line.

BIESSE PARTS

- ✔ Original Biesse spares and spare kits customized for different machine models.
- ✔ Spare part identification support.
- ✔ Offices of DHL, UPS and GLS logistics partners located within the Biesse spare part warehouse, with multiple daily pick-ups.
- ✔ Order fulfillment time optimized thanks to a global distribution network with de-localized, automated warehouses.

92%
of downtime machine orders fulfilled
within 24 hours.

96%
of orders delivered in full on time.

100
spare part staff in Italy and worldwide.

500
orders processed every day.

MADE WITH BIESSE

BIESSE TECHNOLOGY ACCOMPANIES THE GROWTH OF STECHERT

"On these chairs sits the world" is the motto of the Stechert Group that can effectively be taken literally. What began 60 years ago as a small manufacturing company for pram mouldings, furniture doors and door locks is today one of the largest international suppliers of contract and office chairs, as well as tubular steel furniture. Moreover, since 2011 the company has a partnership with WRK GmbH, an international specialist in podiums, conference room and grandstand seating, associated with Stechert via the joint commercial company STW. For Stechert management, however, the excellent results obtained are no excuse for resting on their laurels. On the contrary, the company is investing heavily in the Trautskirchen site to make its production even more efficient and profitable. In the search for a new machinery partner, the company's management chose the Italian manufacturer Biesse. "For the project we chose machines that already had certain options and were predisposed for automation", said Roland Palm, Biesse Area Manager. An effi-

cient production cycle was created in which workers are able to perform at their best after only a short training period.

At the start of the production line is the beam saw "WNT 710" with one cutting line. "Because", explained skilled cabinet maker Martin Rauscher, "we want to be able to work panels of up to 5.90 metres in order to reduce waste as much as possible." Normal rectangular panels for tables or wall panels are taken directly to the "Stream" edgebander with "AirForceSystem" technology. The Biesse edgebander has a group that activates the laminated edging material no longer via a laser beam but using hot air to obtain the so-called "zero gap". "The quality is just as good as the laser system, if not even better: with a connection power of 7.5 kW, the cost per square metre is much lower", underlined the Biesse Area Manager.

"We want to be ready for when we mould the frame ourselves and we must therefore calibrate the panels" said Martin Rauscher, "The same is true of course for solid wood

and multiplex panels, which require grinding before being painted in an external company. For both types of work a Biesse "S1" sander is used. In order to meet the needs of the future, in the Trautskirchen plant there are also two Biesse numerically controlled machining centres: a "Rover C 965 Edge" and a "Rover A 1332 R", which are perfectly complementary. The Stechert Group also intends to strengthen sales of innovative solutions for interior fittings, with complete systems for walls, ceilings, floors and mezzanines. For panel sectioning, the Group has purchased a "Sektor 470". For other geometry, groove and spring machining as well as boring and surface milling, there are two Biesse machining centres, an "Arrow" for nesting applications, a "Rover B 440" and more recently a 5-axis machine, the "Rover C 940 R" machining centre in order to be able to produce, in particular, wall and ceiling panels machined in 3 dimensions.

Source: HK 2/2014



THE BIESSE SIZING RANGE

FLEXIBLE CUTTING



NEXTSTEP



SELCO WN 6 ROS

SINGLE-LINE BEAM SAWS



SELCO WN 2



SELCO SK 3



SELCO SK 4

SINGLE-LINE BEAM SAWS



SELCO WN 6



SELCO WN 7

CUT TO SIZE ANGULAR PLANTS



SELCO WNA 6



SELCO WNA 7



SELCO WNA 8

LIVE THE EXPERIENC

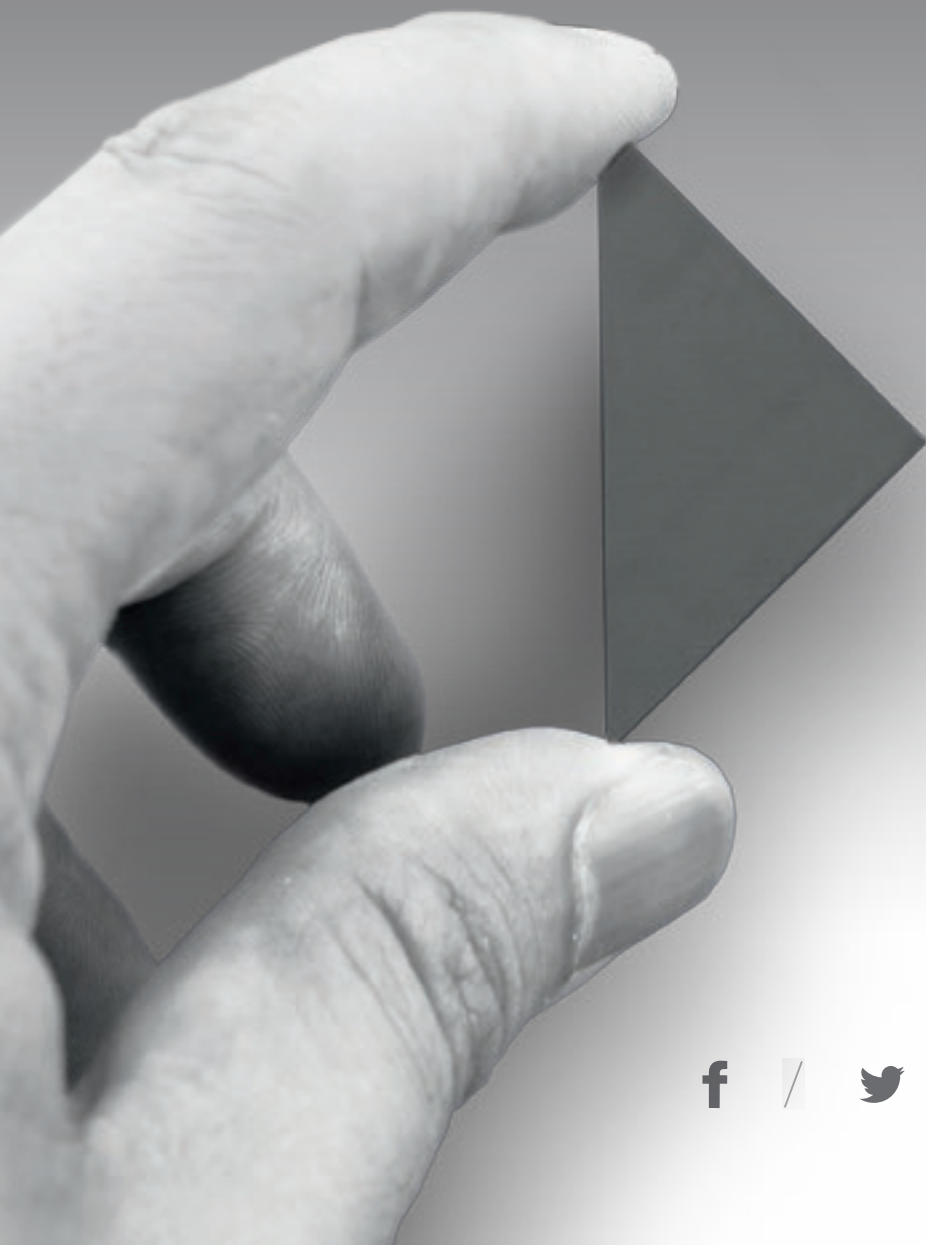

E



Interconnected technologies and advanced services that maximise efficiency and productivity, generating new skills to serve better our customer.

LIVE THE BIESSE GROUP EXPERIENCE AT OUR CAMPUSES ACROSS THE WORLD.

 **BIESSEGROUP**

