

**BOTTOM WORKING
WIDE BELT SANDING MACHINES
WITH 1, 2 OR 3 BELTS**

boere



BOTTOM WORKING WIDE BELT SANDING MACHINES WITH 1, 2 OR 3 BELTS

The compact 'Boere' Wide Belt Sanding Machines are used for the sanding of veneers, solid timber and lacquered workpieces. With the wide choice of models and options, the appropriate specification can be selected for virtually every sanding application.



Machine with one sanding belt

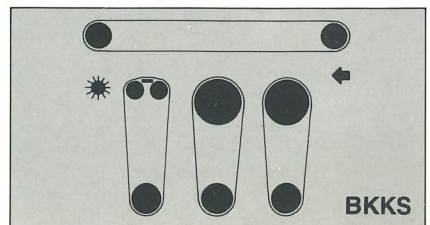
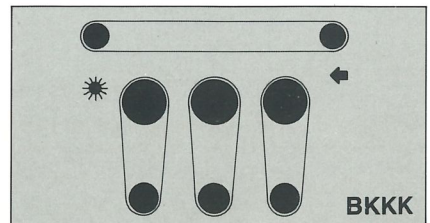
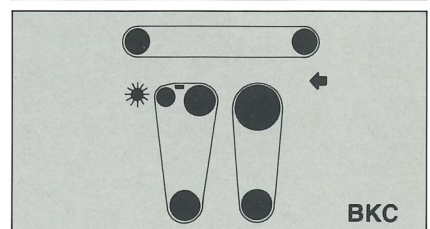
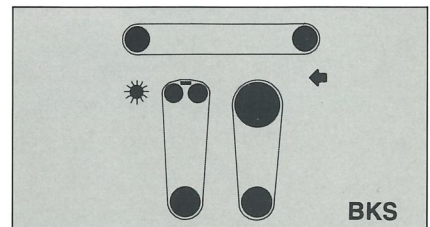
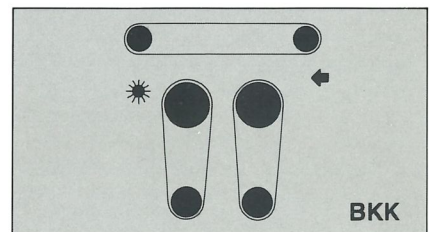
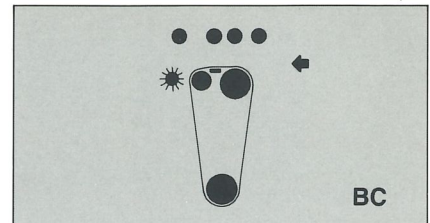
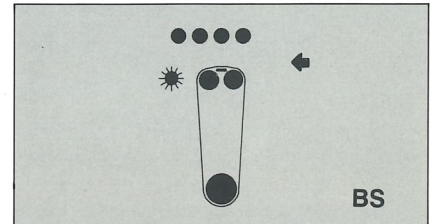
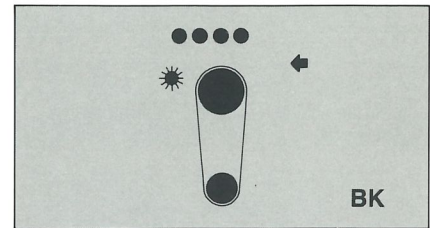

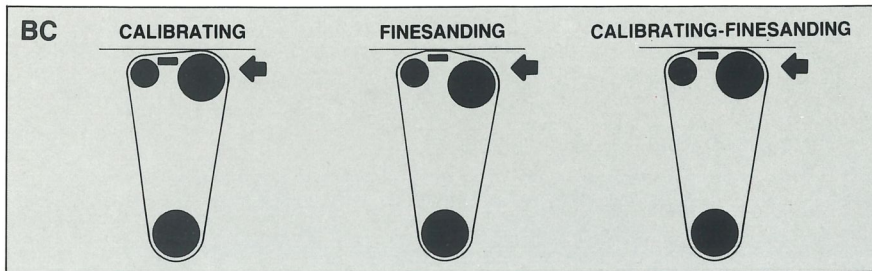

Sanding pad

The sanding pad has especially been constructed for producing a good finish and is supplied in various hardnesses, to suit the type of work required. The pad can quickly and easily be changed. The pressure on the work-piece is pneumatically regulated and it is possible to adjust stock removal precisely.

Contact roller

The contact roller is used, when a great stock removal is required, e.g. for solid wood timber, frames, removal of jointing papers, etc. With the contact roller it is possible to calibrate trouble free to extreme accuracy. The roller can be adjusted very precisely by means of an eccentric. In the contact roller there are spiral grooves, the main purpose of which is to provide the correct and adequate cooling of the sanding belt to achieve maximum efficiency and extended belt life. The machine can be supplied with varying shore hardnesses of rubber, dependent upon the application or even a steel contact roller can be supplied for abrasive planing.

Contact roller and sanding pad unit

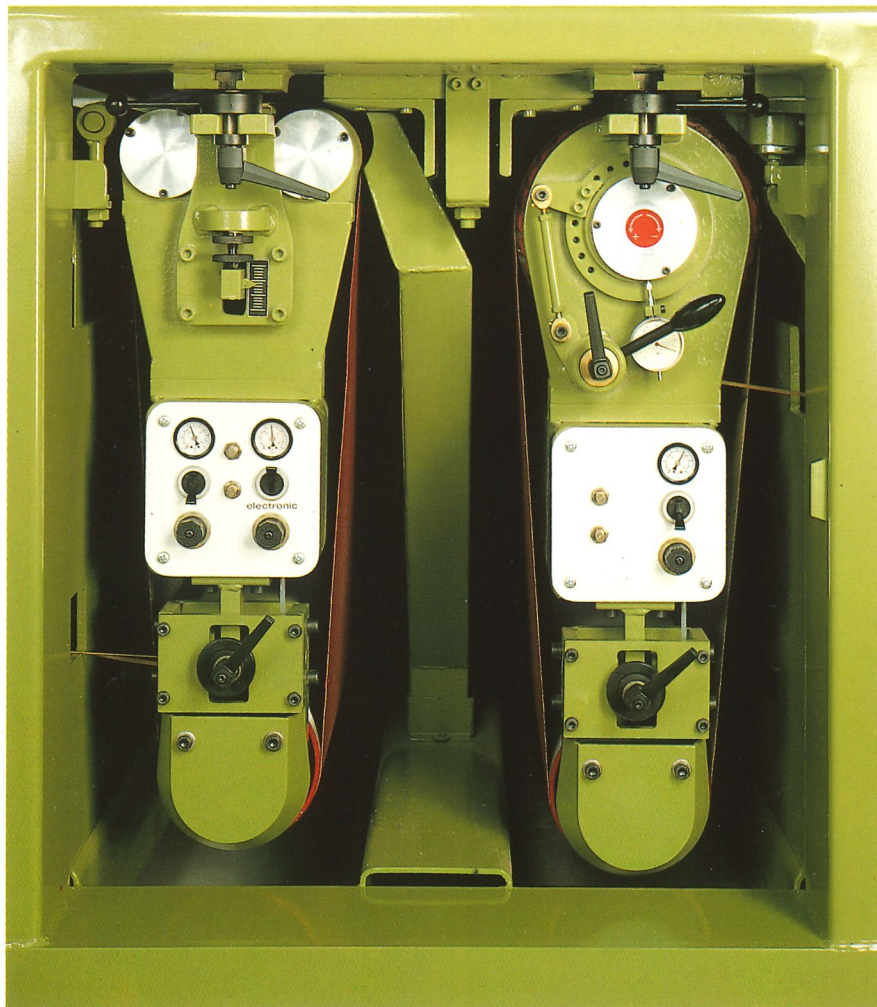

Combi sanding unit

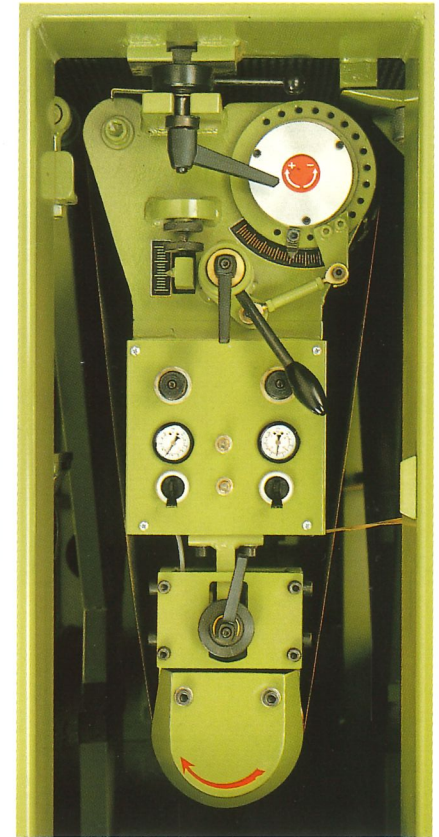

Combi sanding unit

In this unit is incorporated a sanding pad and a contact roller. These can be used either individually or in tandem. When calibrating, the contact roller is used and when fine sanding, the pad is brought into operation or a combination of these functions can be achieved.

boere

Sanding belt

The sanding belt is pneumatically tensioned by a continuously controlled air pressure regulator, ensuring even belt stretch. The belts can be changed with the minimum downtime. The 'Bo-track' modulated belt tracking system operates by scanning one side of the belt and by virtue of its simple construction this feature ensures trouble free operation.

Automatic conveyor belt tracking

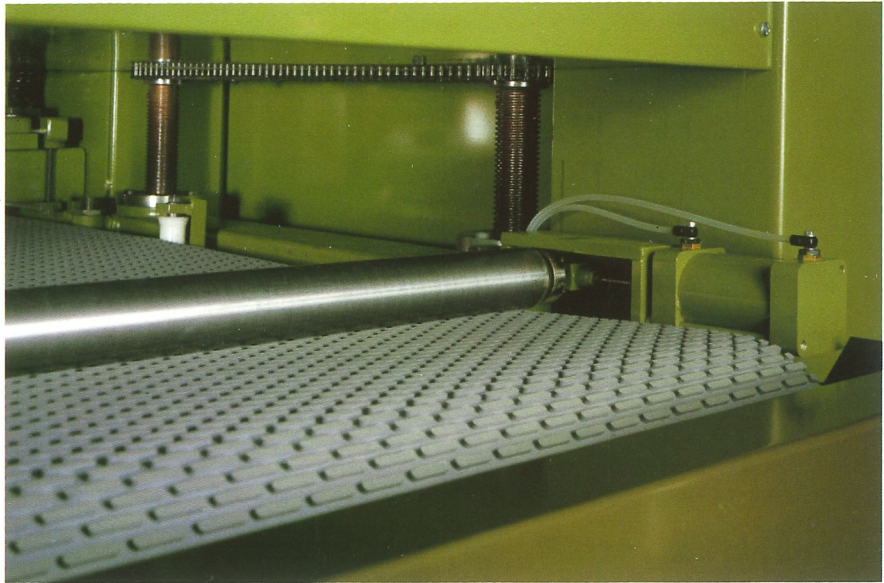

Feed system

The feed conveyor is pneumatically tracked and the whole system is mounted on four square thread spindles to ensure maximum accuracy and incorporates power raise and fall with a digital readout to an accuracy of 0.1 mm. An integral part of the feed unit is the laminated air floating system, which compensates any variation in stock thickness. When calibrating, the lamel-

las can be locked pneumatically. The single head machines (BK, BS or BC) are supplied with a standard system incorporating a rubber roller feed with manual height adjustment indicated by a ruler. The feed system on all the models is infinitely variable from 5-25 metres per minute.

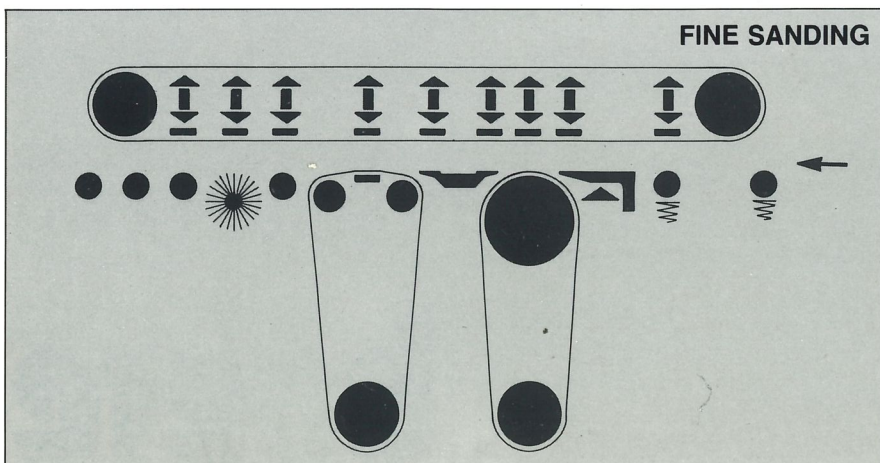
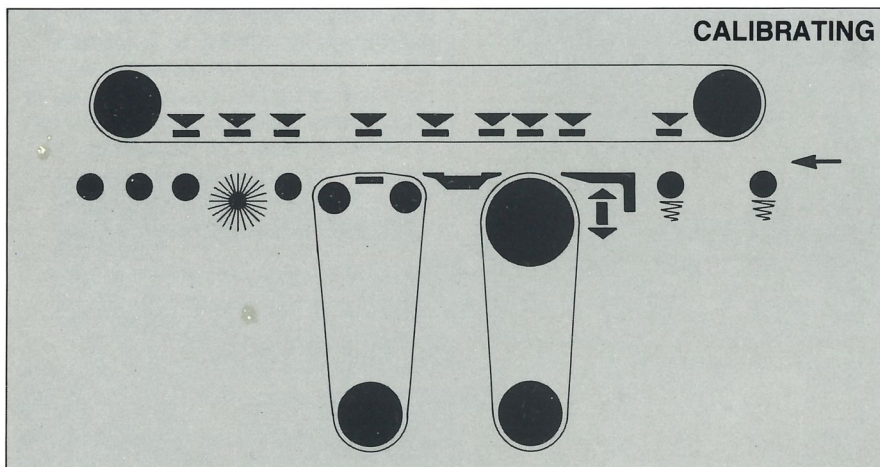

Brush

Standard equipment includes at the outfeed side of the machine a revolving brush with integral exhaust connection to remove the dust, but also to achieve a superior finish by means of its construction.



Built-in brush unit

Electrical switch board

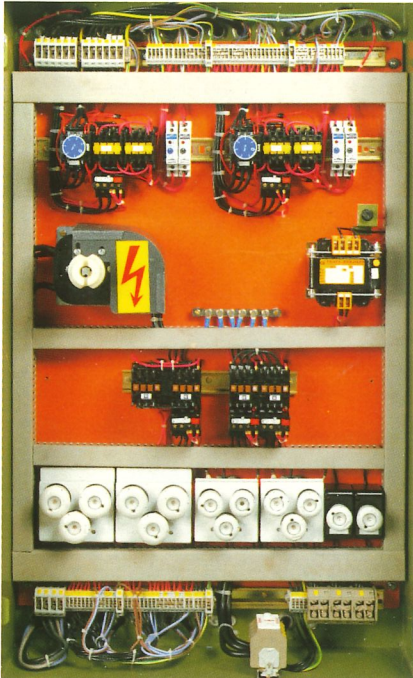

Electrical equipment and safety

The sanding belt motors are started with automatic star-delta switches. All the motors are thermally secured. A built-in pressure gauge closes down the machine, if there is insufficient air pressure available. All the contact roller and combi units are equipped with an automatic brake system. It is not possible to start the sanding belts, if there is insufficient tension applied to the papers. All the 2 and 3 head unit machines are fitted with hand protection and in-built safety against work-pieces which are too thick for the table height setting.

Sanding belt tracking system

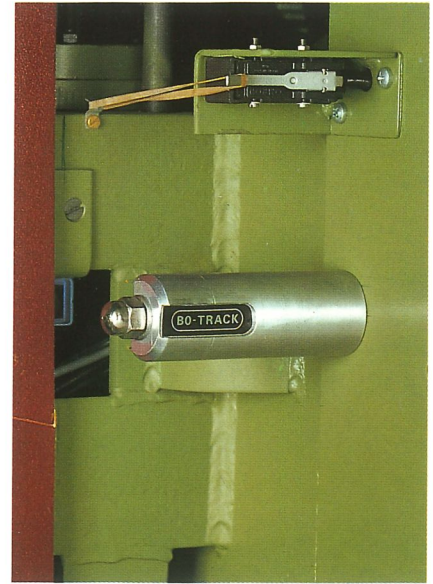

5

Control panel electricity



Control panel

All the operating and control elements are clearly marked and conveniently situated for the operator. Check lights indicate electric tension and air pressure. Ammeters permanently indicate the load of the sanding belt motors and by means of the tumbler switch it is possible to change instantly from veneer sanding to sanding of solid (or the reverse as the case may be).

Control panel pneumatics



boere

6 ACCESSORIES

All the machines are built to a very complete specification, however, for certain sanding techniques it may be necessary to use one or more of the available accessories to improve efficiency, some of which are itemized below.

Air jet belt cleaning device

An air jet cleaning attachment cleans and cools the abrasive to give an extended belt life. In order to clean the belt across its full working width, the air jet belt cleaning unit oscillates, thereby reducing the air consumption.

This attachment is recommended when sanding lacquers and soft species of timber.

Model BKC with air jet belt cleaning devices

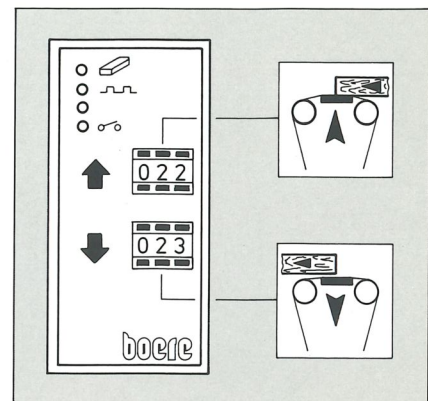
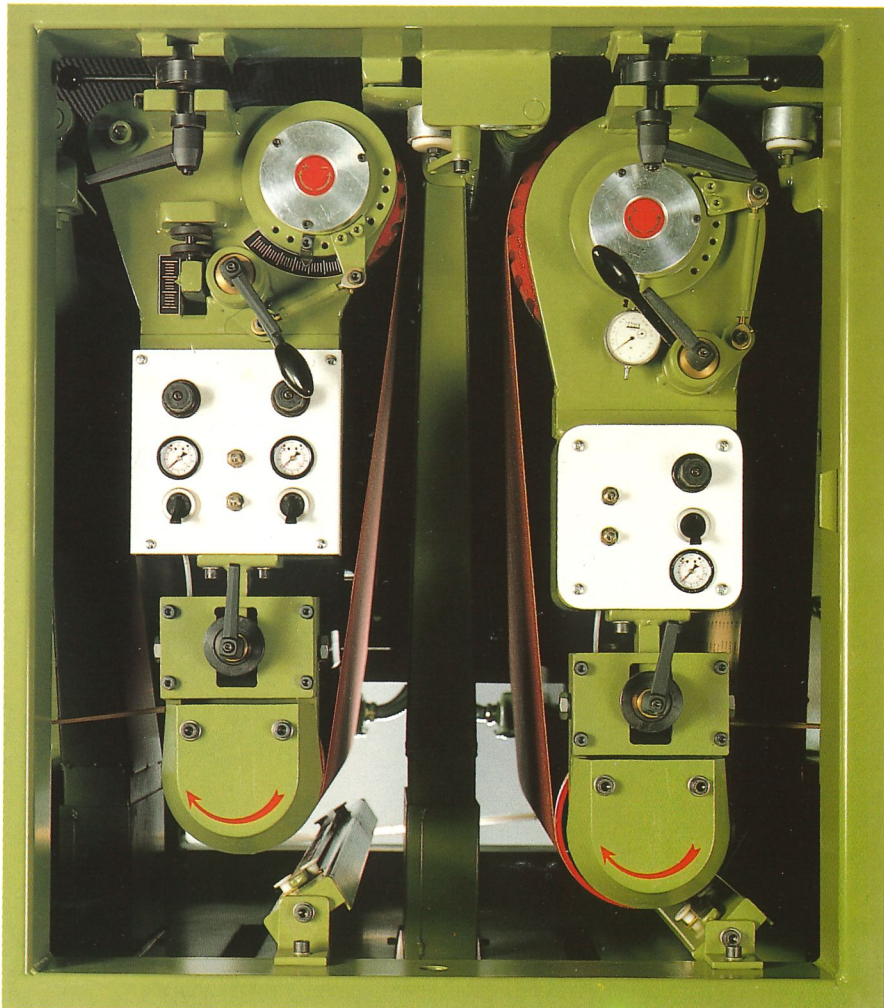

Electronic pneumatically controlled sanding pad

This feature is mainly used for sanding of veneered/lacquered workpieces. The system enables the fall of the sanding pad, at the moment the workpiece comes under the sanding belt and will rise, as the workpiece exits, preventing damage to the leading and trailing edges of the workpiece. This principle avoids the possibility of excessive heat developing and extends the life of the sanding belt. When the feed speed is adjusted, the control compensates automatically.

Other possibilities:

- Greater sanding height.
- Heavier sanding belt motors.
- Two-speed motor for the sanding belt.
- Infinitely variable feed speed of the sanding belt.
- Brake on sanding pad unit.
- Vacuum table.
- Height adjustment with two-speed motor.
- Sensor.
- Anti-noise construction.
- Non-woven abrasive or polishing brush, instead of the standard fibre brush or as an extra brush unit.

Technical data

Sanding width*	upto mm	600	800	900	1000	1100	1300
Stock thickness	upto mm	150	150	150	150	150	150
Sanding belt width	mm	610	810	910	1010	1110	1310
Sanding belt length	mm	1900	1900	1900	1900	1900	1900
Sanding belt motor(s)							
Contact roller	kW(HP)	11(15)	11(15)	11(15)	15(20)	18.5(25)	18.5(25)
Sanding pad	kW(HP)	7.5(10)	11(15)	11(15)	11(15)	15(20)	15(20)
Combi	kW(HP)	7.5(10)	11(15)	11(15)	11(15)	15(20)	15(20)
Feed motor:							
with 1 belt	kW(HP)	0.75(1)	0.75(1)	0.75(1)	0.75(1)	0.75(1)	0.75(1)
with 2 belts	kW(HP)	0.75(1)	1.5 (2)	1.5 (2)	1.5 (2)	1.5 (2)	1.5 (2)
with 3 belts	kW(HP)	1.5 (2)	1.5 (2)	1.5 (2)	1.5 (2)	2.2 (3)	2.2 (3)
Brush motor	kW(HP)	0.55(0.75)	0.55(0.75)	0.55(0.75)	0.55(0.75)	0.55(0.75)	0.55(0.75)
Motor table adjustment							
with 2 belts	kW(HP)	0.12(0.17)	0.12(0.17)	0.12(0.17)	0.12(0.17)	0.12(0.17)	0.12(0.17)
with 3 belts	kW(HP)	0.25(0.33)	0.25(0.33)	0.25(0.33)	0.25(0.33)	0.25(0.33)	0.25(0.33)
Air connection	bar	6	6	6	6	6	6
Air consumption							
with 1 belt	l/min.ca.	4	4	4	4	4	4
with 2 belts	l/min.ca.	8	8	8	8	8	8
with 3 belts	l/min.ca.	12	12	12	12	12	12
Dust connections							
with 1 belt	Ø mm	150	150	150	150	150	150
with 2 belts	Ø mm	2 x 150	2 x 150	2 x 150	2 x 150	2 x 150	2 x 150
with 3 belts	Ø mm	3 x 150	3 x 150	3 x 150	3 x 150	3 x 150	3 x 150
brush	Ø mm	150	150	150	150	150	150
Weight							
with 1 belt	kos ca.	950	1400	1600	1800	2000	2400
with 2 belts	kos ca.	2000	2300	2500	2700	2900	3300
with 3 belts	kos ca.	2900	3200	3400	3700	3900	4300

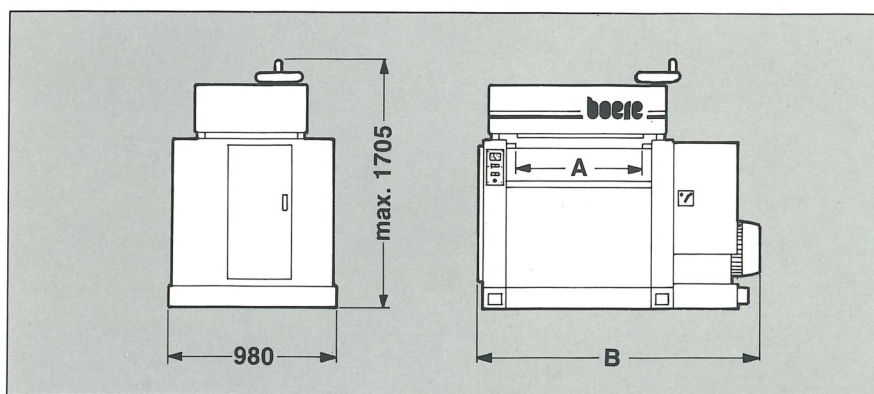

Machine with 1 sanding belt

A*	B
600 mm	1620 mm
800 mm	1820 mm
900 mm	1920 mm
1000 mm	2020 mm
1100 mm	2120 mm
1300 mm	2320 mm

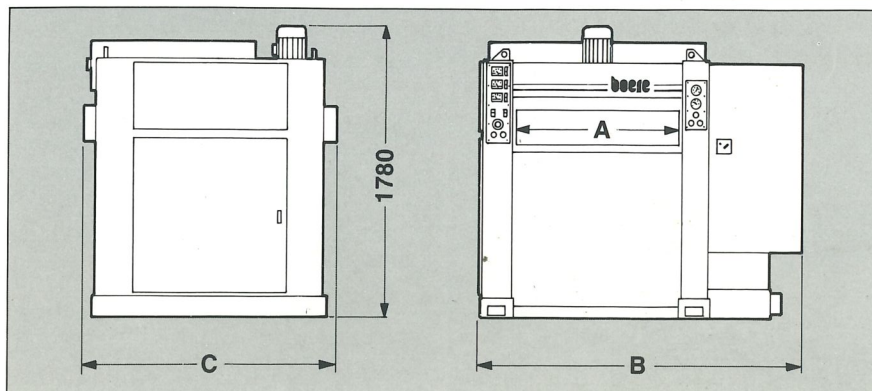

Machine with 2, 3 sanding belts

A*	B
600 mm	1780 mm
800 mm	1980 mm
900 mm	2080 mm
1000 mm	2180 mm
1100 mm	2280 mm
1300 mm	2480 mm

C	
with 2 belts	1580 mm
with 3 belts	2000 mm

We reserve the right to amend specification and price without prior notification as our policy is one of constant improvement!
Measurements and weights without engagement!

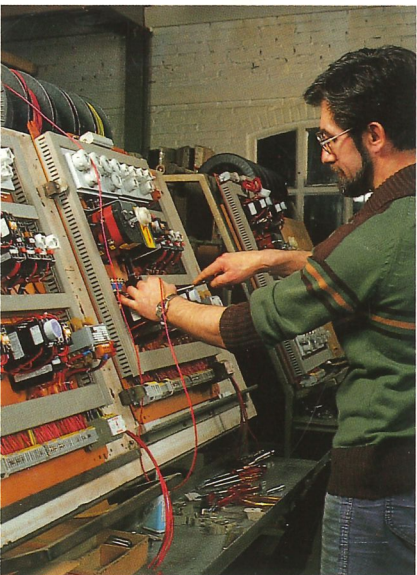
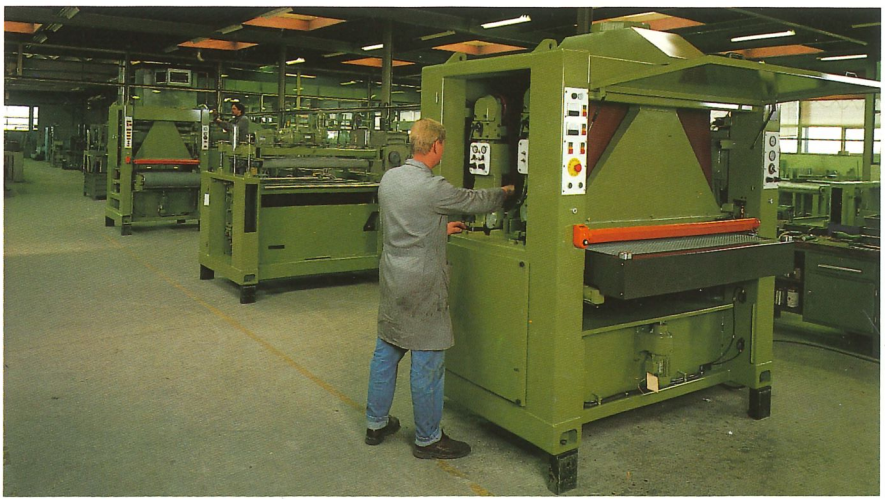

Calibrating
Planing
Pre-sanding
Fine sanding
Finish sanding
Lacquer sanding

boere
Perfection in sanding

**B.V. Machine- en
Apparatenfabriek J. Boere**

Waddinxveen - Holland
Brugweg 121
P.O. Box 8 - 2740 AA Waddinxveen
Phone: 31-1828-14400
Telex : 20721 boere nl
Facsimile: 31-1828-18349