

www.esetre.com
E-mail: info@esetre.com

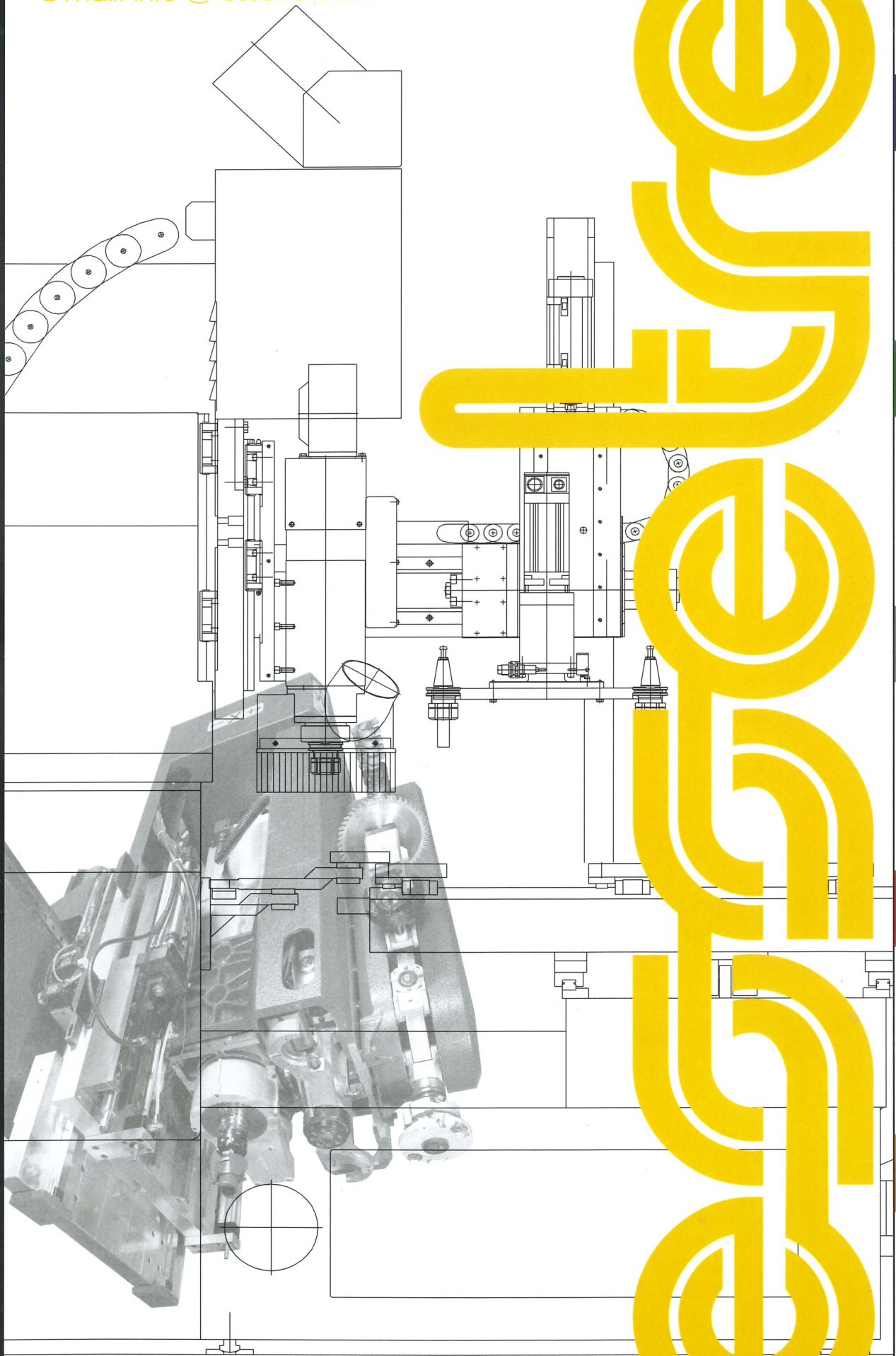

CNC MACHINING CENTRES



La produzione di Essetre si sviluppa su una superficie di 3.000 mq. Con una forza lavoro di 40 dipendenti.

Essetre production extends itself on a 3.000 m² surface with a labour force of 40 workers.

La producción Essetre se desarrolla en un establecimiento con una superficie de 3000 metros cuadrados y cuenta 40 empleados.

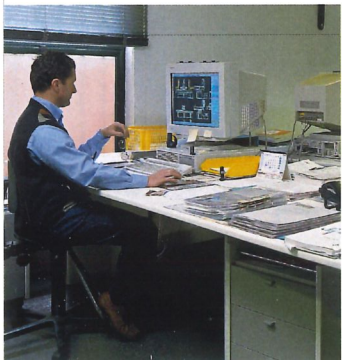
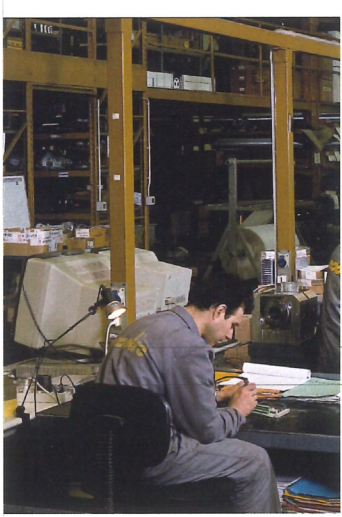

IL GRUPPO THE COMPANY EL GRUPO

VISTE DELLO STABILIMENTO VIEWS OF THE WORKS VISTAS DE L'ESTABLECIMIENTO



Nel 1999 diventa un gruppo industriale acquisendo la UTITA, situata ad Ospedaletto Euganeo (PADOVA), specializzata in torni a CNC di grossa taglia per la lavorazione di metalli.

UTITA conta attualmente su una forza lavoro di circa 40 dipendenti e, di recente, svolge l'attività produttiva su un nuovissimo stabilimento di 6.000 mq coperti.

Alla produzione tipica di torni, è affiancata anche quella Essetre.



utita



In 1999 Essetre becomes an industrial group acquiring UTITA, located in Ospedaletto Euganeo (PADOVA) and specialised in big size CNC lathes for metal manufacturing.

UTITA has, at present, a labour force of about 40 workers and, in recent times, carries out its productive activity in a new works of 6.000 roofed m².

To their typical production of lathes it is put beside also Essetre production.

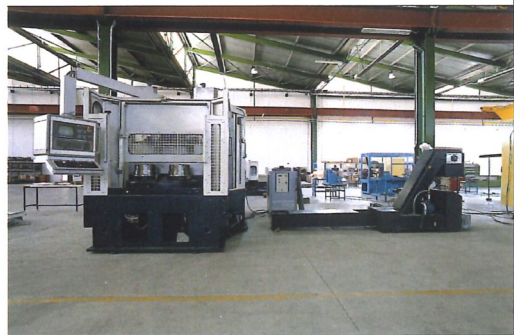

En el 1999 deviene un grupo industrial adquiriendo la UTITA de Ospedaletto Euganeo (PADOVA), especializada en grandes tornos a CNC para trabajar metales. Actualmente UTITA cuenta aproximadamente 40 empleados y recientemente desarrolla su actividad productiva en una nueva fábrica de 6000 m² cubiertos. Junto a la producción típica de tornos, UTITA ha agregado también la producción Essetre.

Viste del nuovo stabilimento

VIEWS OF THE NEW WORKS

VISTA DEL NUEVO ESTABLECIMIENTO

3 . UTITA

esetire

4 - LE MACCHINE STORICHE
THE HISTORICAL MACHINES
LAS MAQUINARIAS HISTORICAS



1979

FRESATRICE COPIATRICE MANUALE
MANUAL COPYING ROUTER
MAQUINA FRESADORA COPIADORA MANUAL

PRIMA MACCHINA ESSETRE
FIRST MACHINE ESSETRE
PRIMERA MAQUINA ESSETRE

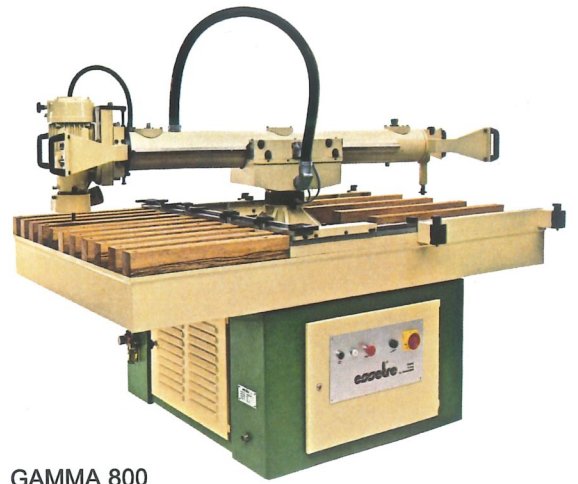

GAMMA 80



GAMMATRONIC 4211 TOPS



GAMMATRONIC 208

PRIMA MACCHINA A CONTROLLO NUMERICO
FIRST NUMERICALLY CONTROLLED MACHINE
PRIMERA MAQUINA A CONTROL NUMÉRICO



GAMMATRONIC 25.9 c.u.a.

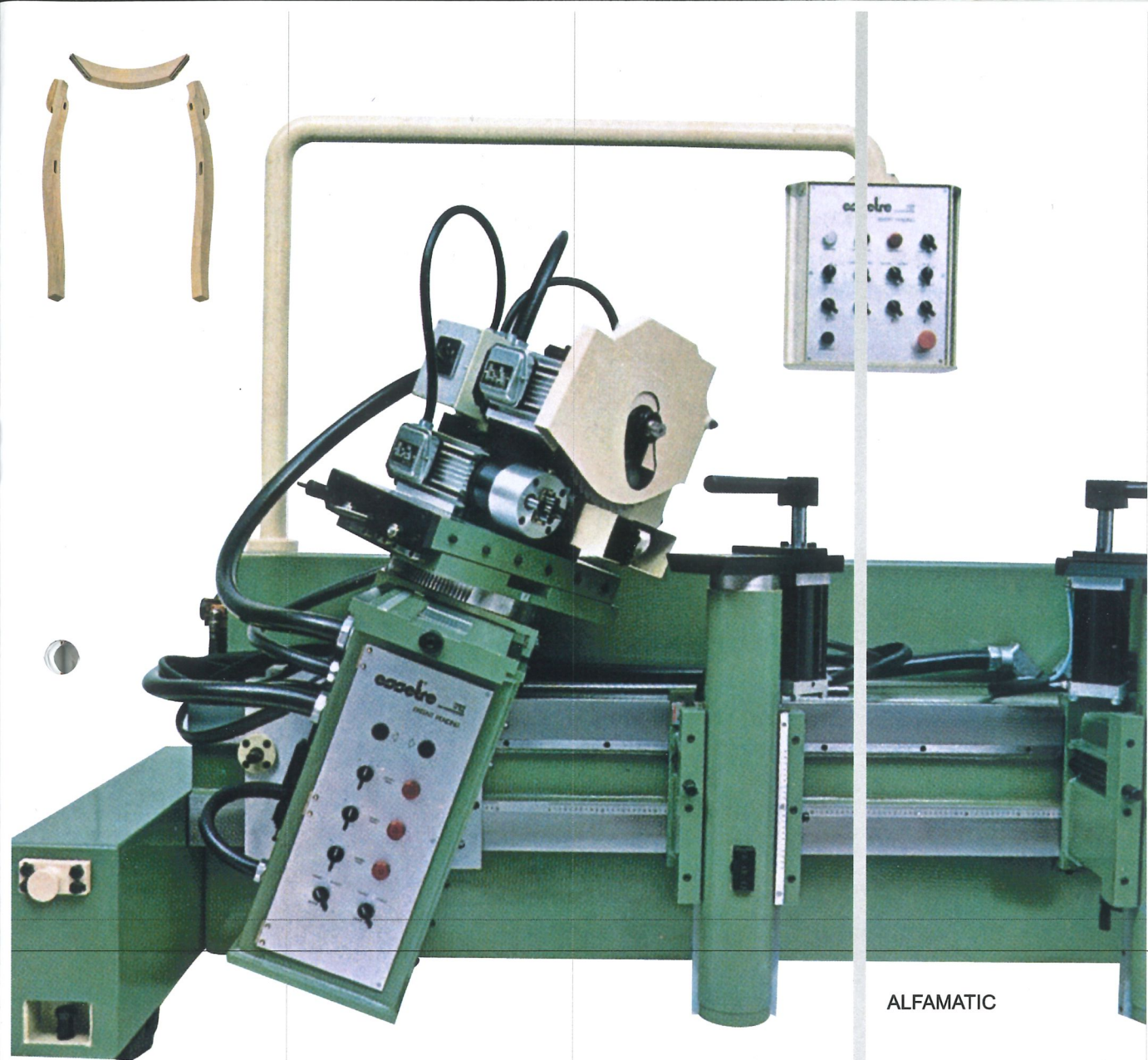

ALFAMATIC



MAXITRONIC 1993
MACCHINA CON N° 2
GRUPPI A 5 ASSI
MACHINE WITH N° 2
5-AXES GROUPS
MAQUINA CON 2 GRUPOS
DE TRABAJOS CON 5 EJES

esetire

SETTORI DI PRODUZIONE
SECTORES DE PRODUCCIÓN
PRODUCTION AREAS

6 -



CURVED PIECES - PIEZAS CURVADAS
PEZZI CURVATI



TOPS PRODUCTION - PRODUCCIÓN TOPS
PRODUZIONE TOPS



PRODUCTION LINES - LINEAS DE PRODUCCIÓN
LINEE DI PRODUZIONE



PAN
PANNELLO



SOLID WOOD - MACIZO
MASSICCIO



SPECIAL PRODUCTION - ESPECIAL
SPECIALE

GAMMA 1025 TG4
GAMMA 3210 TG4
GAMMA 3211 V TG4
GAMMATRONIC TRP TG4
GAMMATRONIC TRP TG5
GAMMATRONIC TRP TR6
GANTRY TG5

TOP SAW
TOP BORD
GAMMA 4210 TG180
MULTITRONIC
GAMMA 800

ENGINEERING
SOFTWARE

GANTRY
LEONARDO
REFIL
AUTOREFIL

GANTRY
GANTRY TG5
LEONARDO

A large, bold, black exclamation mark followed by a large, bold, black question mark. The background of the entire page is a grayscale photograph of a modern industrial building with large glass windows and a parking lot filled with cars. The text is overlaid on this background.

espetre



CURVED PIECES - PIEZAS CURVADAS
PEZZI CURVATI

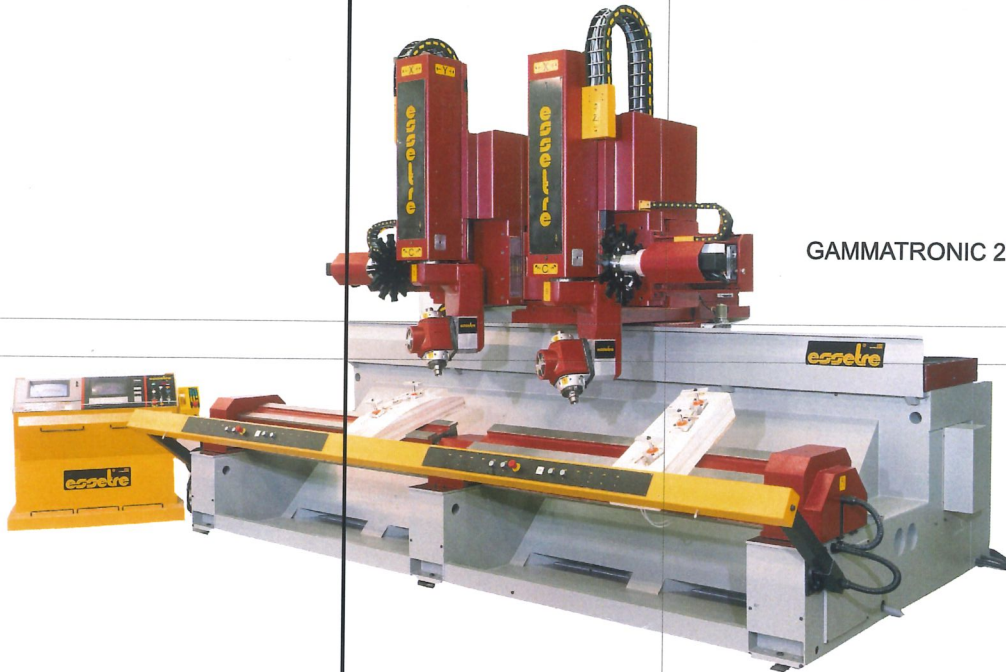

GAMMATRONIC 2TRP 2TG5



GAMMA 3211 VTG4

GAMMA 1025 TG4
GAMMA 3210 TG4
GAMMA 3211 V TG4
GAMMATRONIC TRP TG4
GAMMATRONIC TRP TG5
GAMMATRONIC TRP TR6
GANTRY TG5

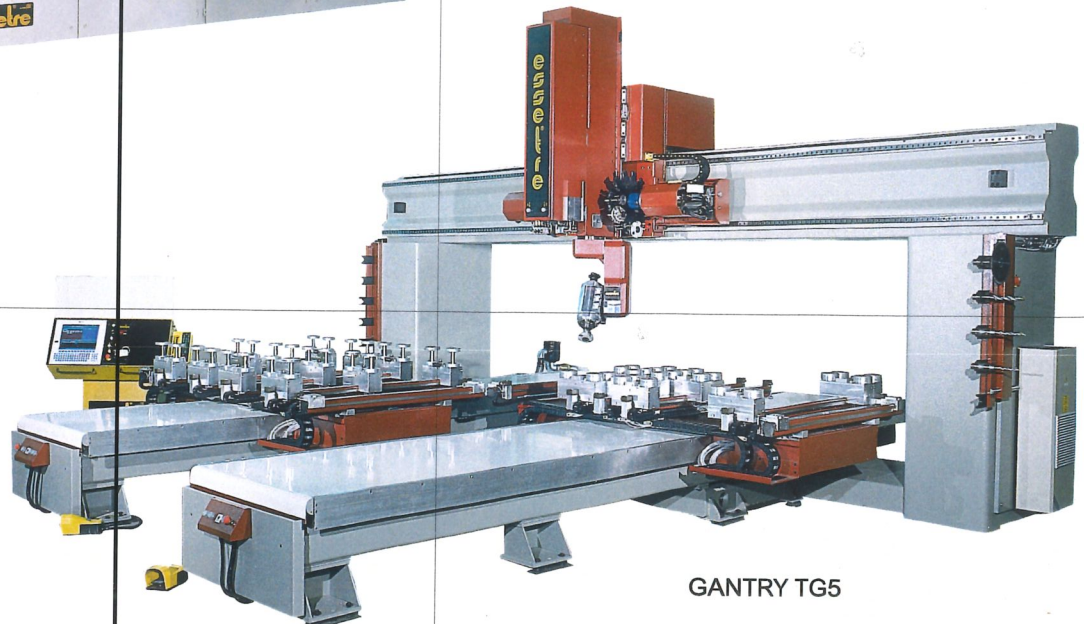

GANTRY TG5



SETTORI DI PRODUZIONE
PRODUCTION AREAS
SECTORES DE PRODUCCIÓN





TOPS PRODUCTION - PRODUCCIÓN TOPS
PRODUZIONE TOPS

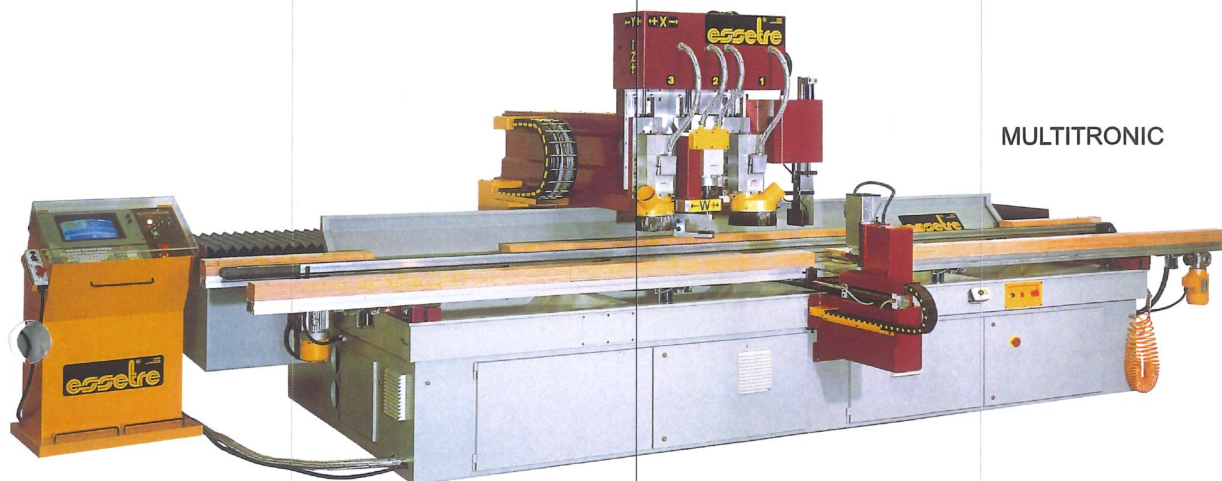

MULTITRONIC

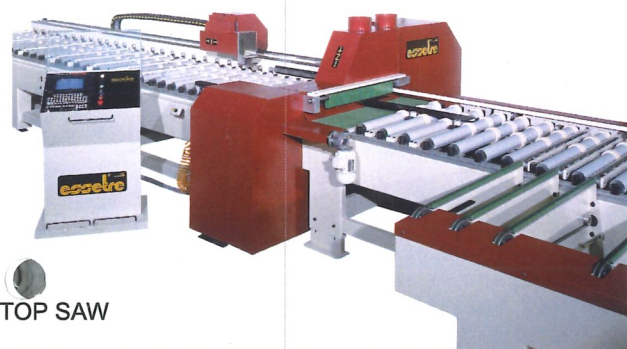

TOP SAW

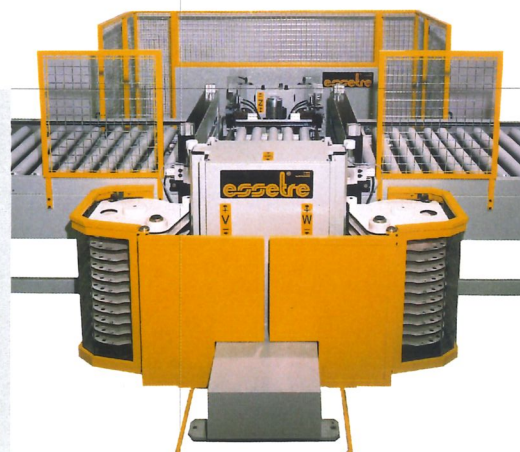

TOP BORD

TOP SAW
TOP BORD
GAMMA 4210 TG180
MULTITRONIC
GAMMA 800



essetre



PANEL
PANNELLO



SETTORI DI PRODUZIONE
PRODUCTION AREAS
SECTORES DE PRODUCCIÓN

10

GANTRY TG5

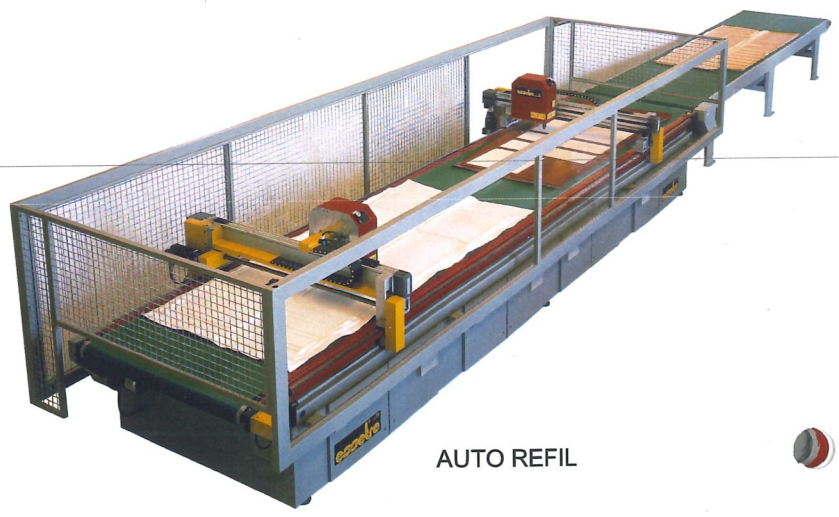

AUTO REFIL

GANTRY
LEONARDO
REFIL
AUTOREFIL

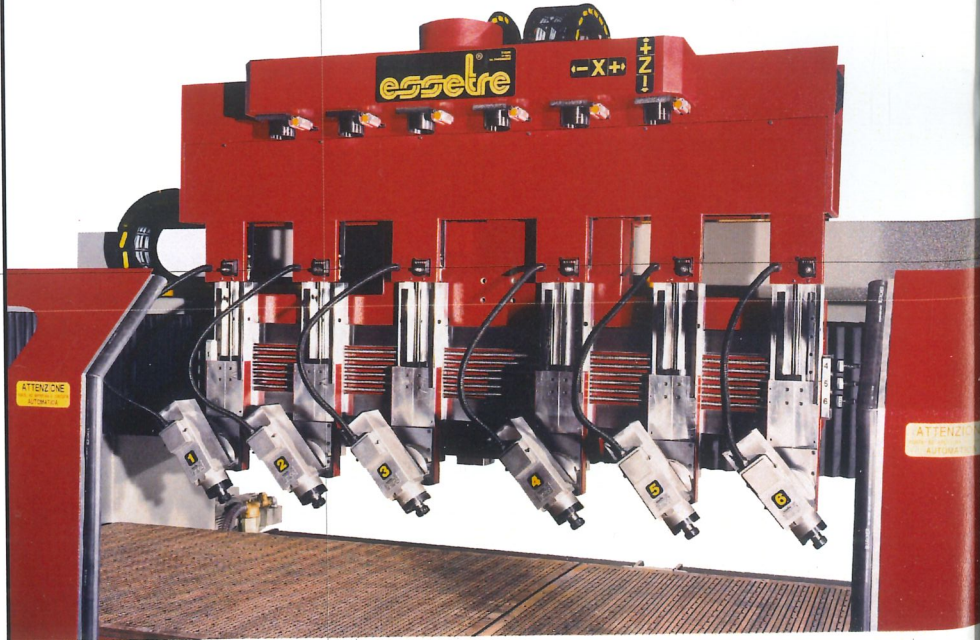

SOLID WOOD - MACIZO
MASSICCIO



LEONARDO

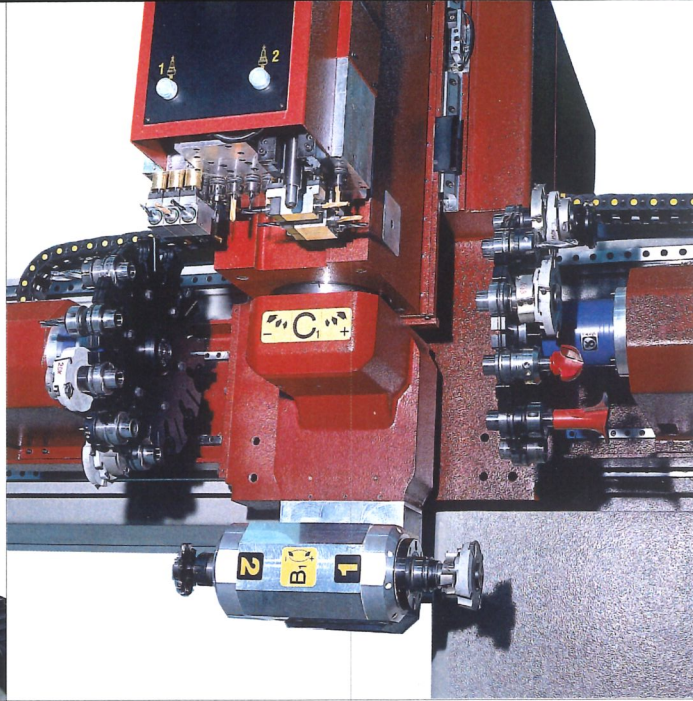

GANTRY
GANTRY TG5
TECHNO
LEONARDO

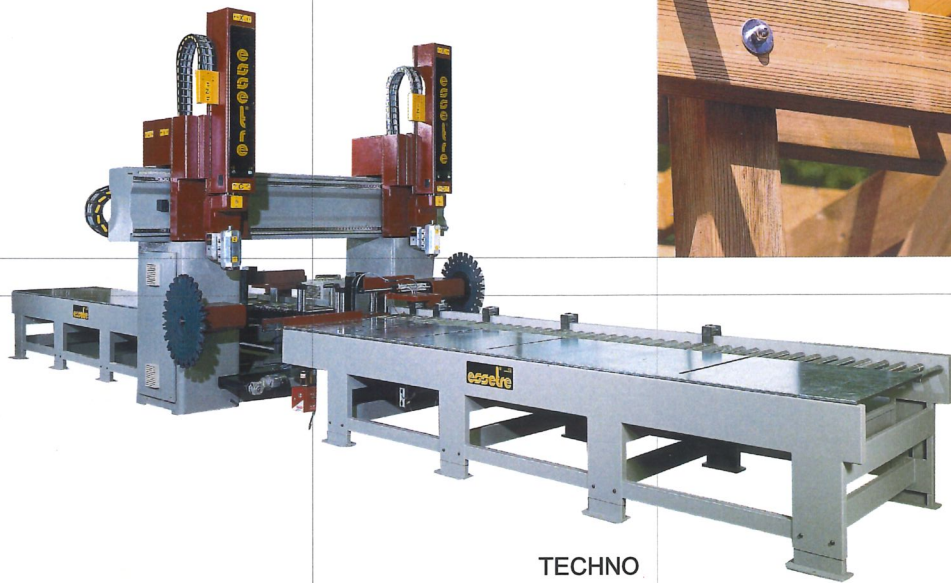

TECHNO

PRODUCTION LINES - LINEAS DE PRODUCCIÓN
LINEE DI PRODUZIONE

SPECIAL PRODUCTION - ESPECIAL
SPECIALE

info

ESSETRE S.p.A.
Viadellavoro, 10
36010-THIENE
(VICENZA)Italy

Tel. +39 0445 365 999
Fax +39 0445 360 195

Http:// www.essetre.com

E-mail: info@essetre.com

E-mail: comm@essetre.com

ESSETRE UK LTD

40 High Street, Daventry, Northants, NN11 4HU
direct line +44 (0) 1327 878790 - direct fax +44 (0) 1327 312824

ESSETRE IBERICA Calle Utiel, 56 El Vedat TORRENT - VALENCIA
Tel. +34 961 588 064 - Fax +34 961 588 498