



HOLZHER

Glu Jet



Intelligent Edgebanding

- Program selection at the touch of a button.
- Alternative: fully automatic with barcode.

Superior appearance for all materials

Starting with the state-of-the-art high gloss edging right up to solid wood edging with cross section of 30 x 65 mm, HOLZ-HER remains unequalled for variety.

HOLZ-HER sets the trends for tomorrow today.

- Solid wood edging
- Veneer edging
- Plastic edging
- Aluminum edging
- Formica edging
- Melamine resin edging
- and many others

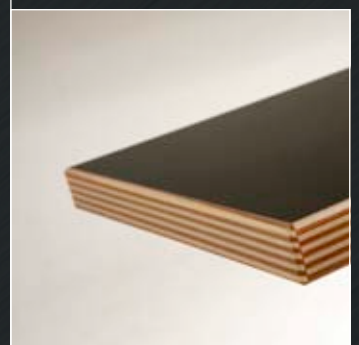
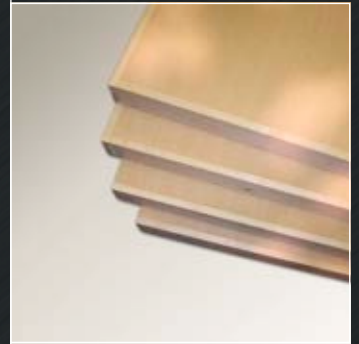

HOLZ-HER Glu Jet System Invisible joints with thin film technology

Ultra-thin glue joints, easily equivalent to industrial laser edges, are easy to achieve with the HOLZ-HER Glu Jet System, which also offers unrivaled flexibility.

The clear advantages of the hybrid technology in combination with the new HOLZ-HER thin film technology, make this gluing system the all rounder for craftsmen and industrial users. Visual zero joints with PUR glue – allowing use in wet areas – are only natural for HOLZ-HER customers.



Innovative technology for one-of-a-kind edging results

Three independent heating circuits

- The ring heater [1] heats up the front section of the cartridge, expanding the cartridge and thus sealing the melting area hermetically.
- The main heater [2] heats the hot melt glue up to operating temperature. This is all accomplished in less than one minute.
- The nozzle heater [3] heats the entire steel nozzle up to the precisely desired temperature. This requires approximately 3 minutes.

Glue application

- The pressure cylinder [4] presses the cartridge or the granules against the heater elements at a maximum pressure of 6 bars.

- The hot glue rises in the metering rod [5] and can then be processed. The control opens and closes the metering rod to meter the glue precisely under pressure to the Glu Jet nozzle [6].

Automatic replenishment

- The pressure cylinder presses the cartridge or granules against the heater elements. After reaching a certain position, the sensor sends a replenishment signal to the control. As long as glue is being applied to a workpiece, charging is delayed until the work is finished. The pressure cylinder retracts automatically, a new cartridge or fresh granulated material drops from the cartridge supply hopper [7] in to the heating shaft where it is again pressed against the heating elements (Glu Jet automatic).

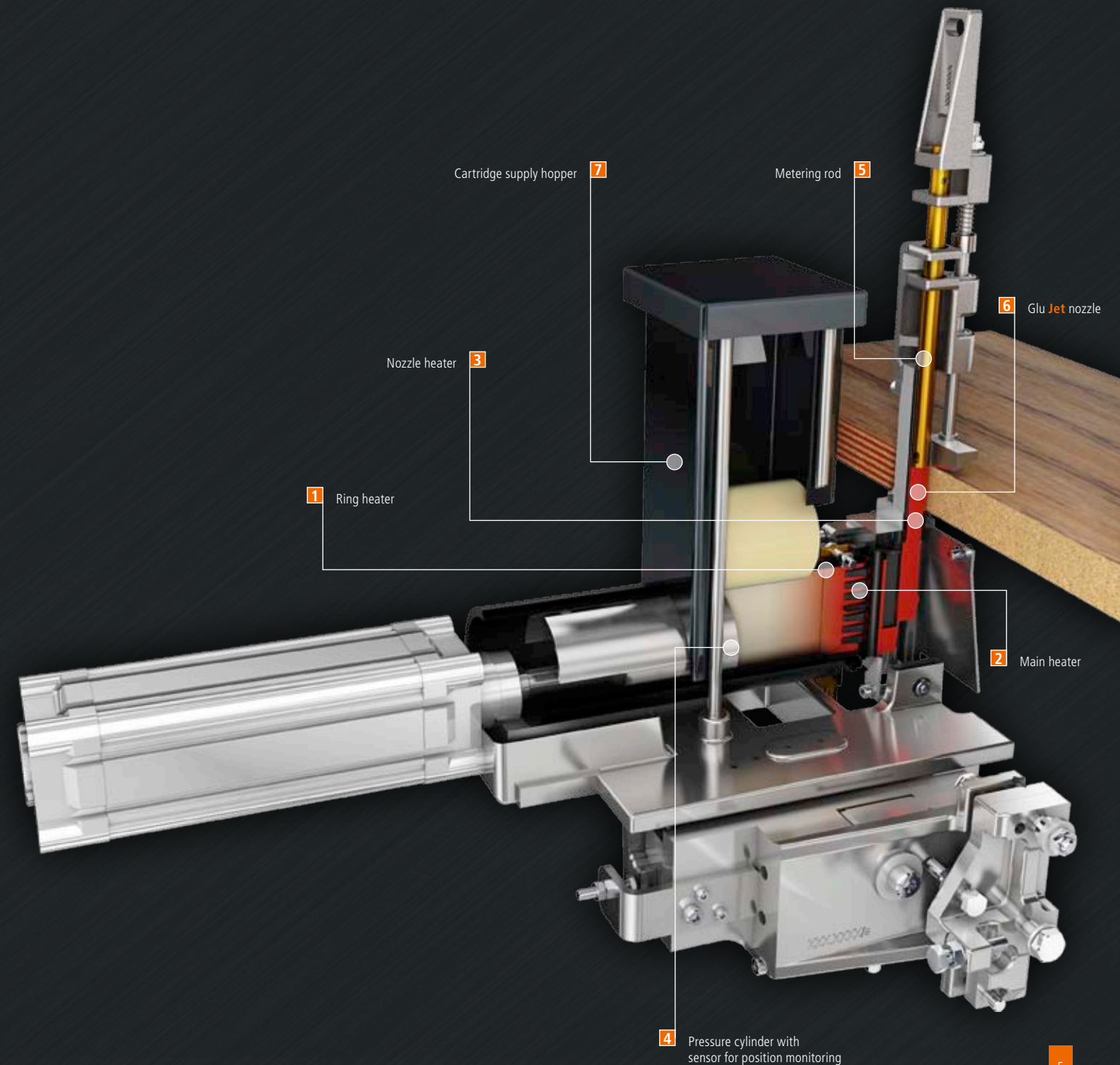

Tracing nozzle

Precision at the highest level

The Glu **Jet** with its optimized nozzle design arrangement automatically adapts to all common panel thicknesses worldwide.

- The tracing nozzle [1] automatically compensates panel thickness tolerances.
- The sensing shoe is spring mounted and opens the nozzle to exactly the panel thickness sensed.
- This results in perfect, clean glue application even on panels with highly varying thicknesses.

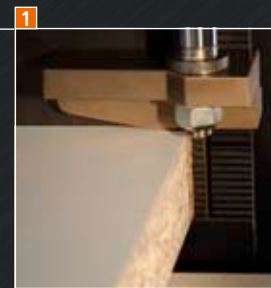

Tracing nozzle

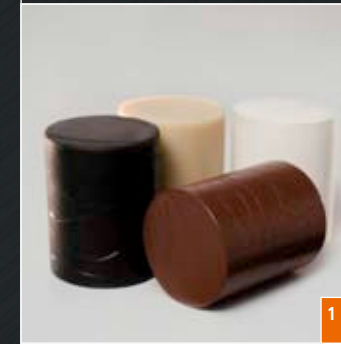

EXTREMELY
WATER-RESISTANT

Industrial glue systems

for permanent joints

Glue cartridge [1]

The water-resistant properties of polyurethane glue provide enormous advantages, particularly in the area of furniture for baths and kitchens. HOLZ-HER's standard features always allow you to use PUR glue as well as easily remove it completely from the system without residues through a purging hole at the touch of a button with special neutralization cartridges or granule cleaner.

EVA = Ethylene vinyl acetate

PUR = Polyurethane

Both substances are cross-linked plastics, which act as an "adhesive" between the workpiece and edging following a chemical reaction from heating and cooling.

Glue granules [2]

All common types of glue are also available in granule form and can be processed in the HOLZ-HER Glu **Jet** System. For this purpose HOLZ-HER provides practical granule hoppers in various sizes, which can be quickly and easily changed on the machine.



Hybrid technology

Two perfectly combined systems

The edgebander is decisive for furniture with a high quality appearance. You can also profit from 45 years of HOLZ-HER technological leadership in edgebanding.

- Change over from colored to neutral glue at the flick of the wrist.
- Change over from cartridge to granule form in minutes.
- Change over from EVA to PUR glue also possible within the shortest time.
- And the entire system can also be completely cleaned in just a few minutes.

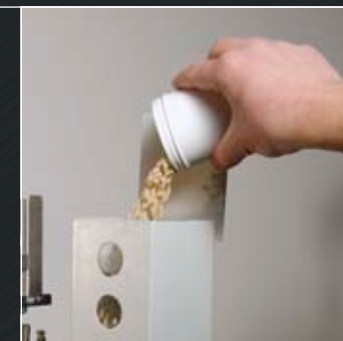
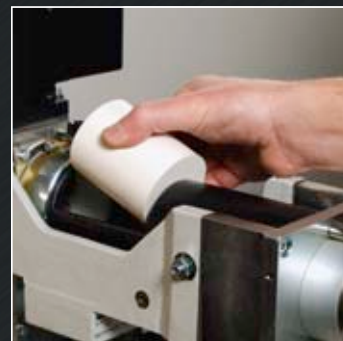
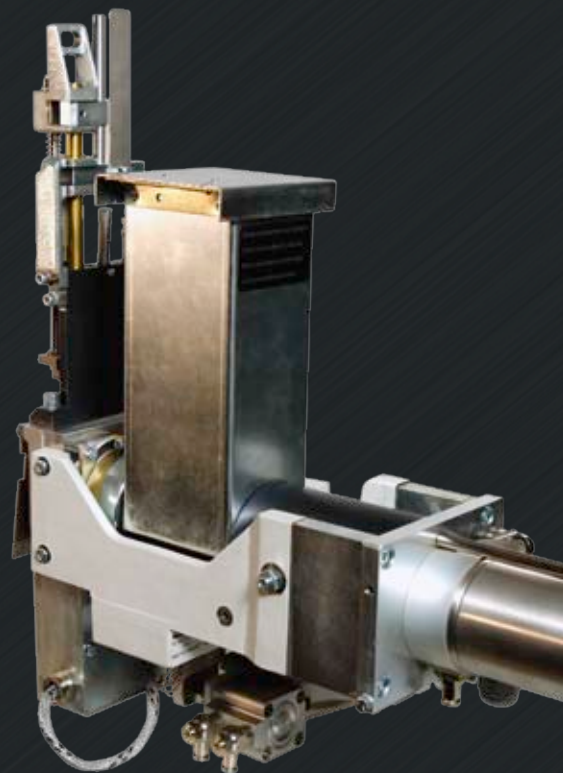

Cleaning cartridges and granule cleaner



System advantages

Top quality – highly flexible,
time and energy saving

- The slit nozzle applies the glue to the panel exactly at a pressure of 6 bars. This ensures a strong joint between the panel and edging.
- Sensing allows precise height adjustment of the system to the panel thickness.
- Easy processing of various types of glue. EVA or PUR – all types of glue can be processed in cartridge or granule form.
- Can hold up to four cartridges or up to 1.5 kg of granule material (Option: 5 kg hopper).
- Sealed system prevents unpleasant odors from escaping glue vapors.
- Simple color change ensures that glued joint matches decoration.
- The nozzle design ensures homogeneous glue application.
- Slim nozzle design ensures smaller infeed angle. Reliable machining of edging up to 30 mm.
- Glue is applied exactly as required. This saves costs and optimizes quality.
- The glue is never discolored or burned, because only the required amount of glue is melted in the sealed system.
- Rational change from glue cartridge to glue granules – simply change supply hopper and type of glue.
- Extremely short heat-up time of 3 minutes. Valuable production time is saved and energy costs reduced.
- Purging hole for automatic cleaning system – e.g. cleaning out PUR glue
- Low maintenance requirements provide additional cost reduction.



Illustrations may contain optional features.

UK – HOLZ-HER 3134 25 – Printed in Germany/Imprimé en Allemagne
Printed on: 23.04.2012 – First edition: 07.03.2012



HOLZHER

HOLZ-HER GmbH

D-72622 Nürtingen

Tel.: +49 (0) 70 22 702-0

Fax: +49 (0) 70 22 702-101

www.holzher.com