

Edge banding and combination machines  
K 520 profiLine – Series production in superb quality

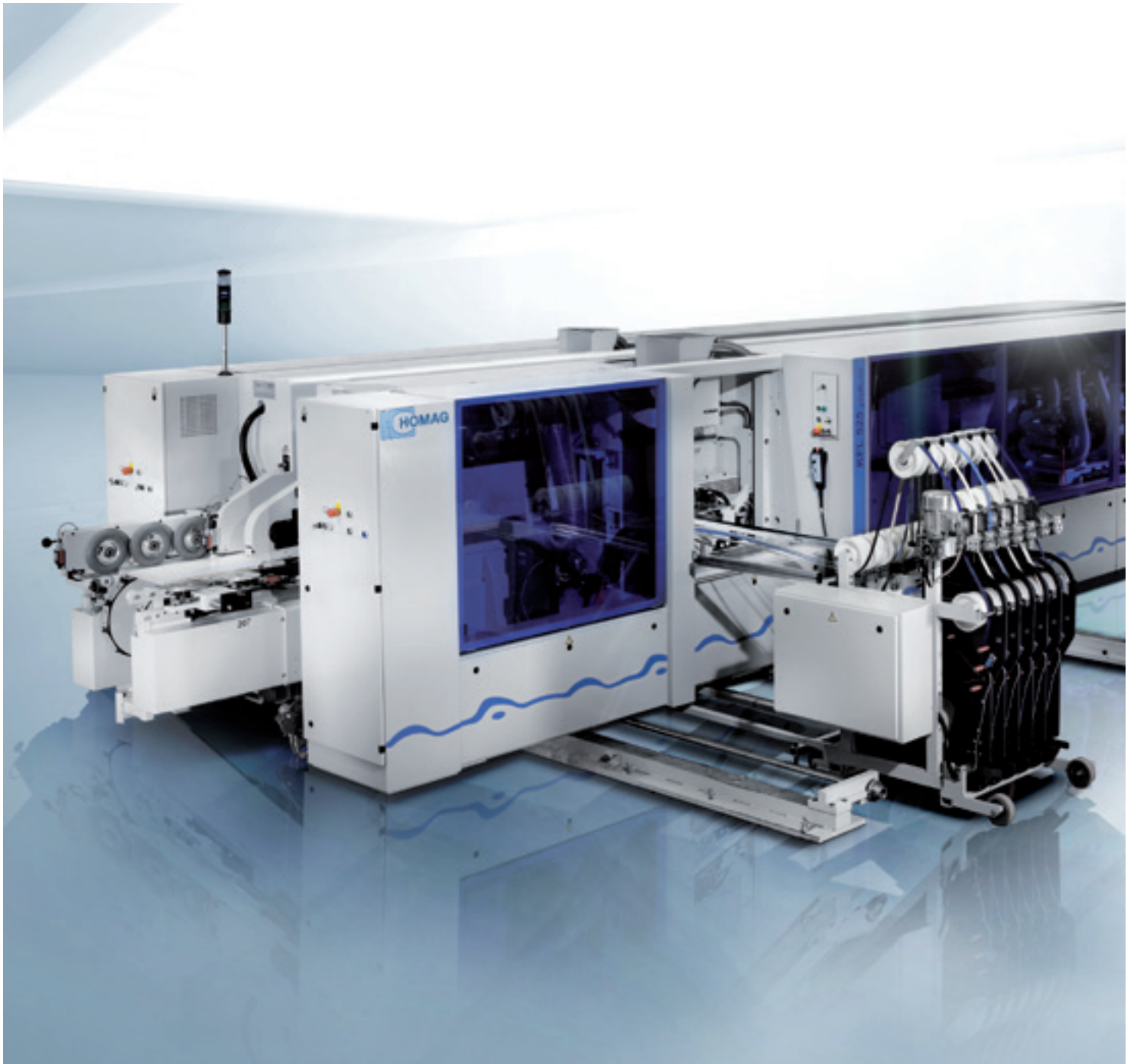





## Is top class quality a priority to you? Then you have come to the right address with HOMAG!

In today's world, good is simply no longer good enough. Only by delivering furniture in absolute premium quality can you be sure of staying out in front of your competitors. An item of furniture tells its own story about how and on which machine it was produced. The edge progression and joint quality must be just right every time – and by producing with plants and machines from HOMAG you know they will be. Using high-performance HOMAG machines is your guarantee of outstanding efficiency. A high level of machine availability and top-class quality make for satisfied customers.

### Contents

- 04** K 520 profiLine – the standard in edge banding
- 06** The HOMAG K 520 series –  
as variable as your production needs
- 07** Greater economy due to a long service life and optimum  
availability
- 08** Efficiency through series production
- 10** Our range of modular units – always up to date
- 26** Productivity – only as good as the control system
- 28** Feeding and stacking systems –  
compact and economical
- 30** Rotary stations – taking a turn for the better
- 32** HOMAG Life Cycle Services
- 34** Technical data

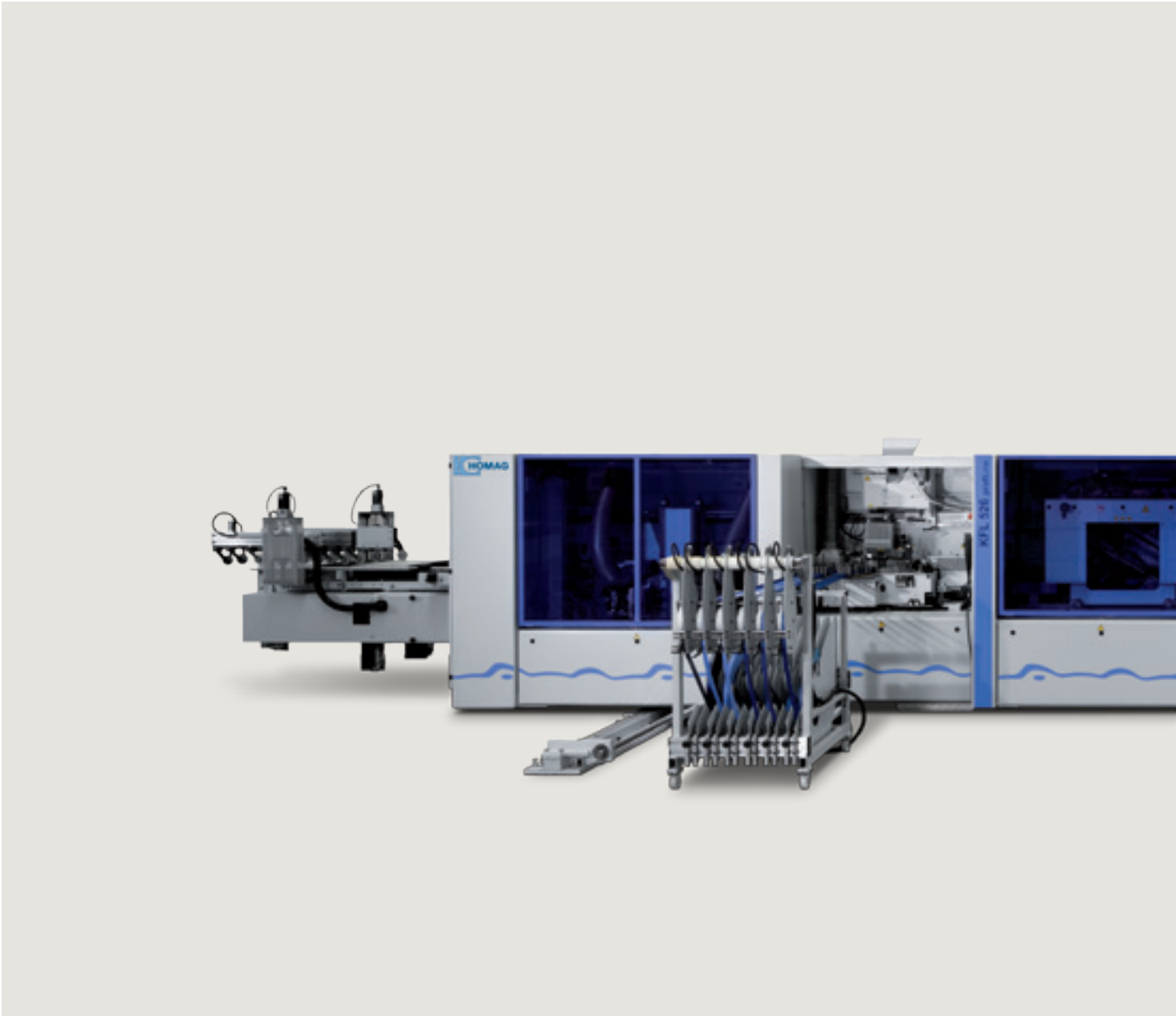

## K 520 profiLine – the standard in edge banding

The K 520 profiLine is the culmination of many years of accumulated expertise tried and tested in our high-performance machine ranges. As a result, the K 520 profiLine can be used for practically any type of edging material. Which makes it more efficient and more flexible. And this series has all the hallmarks of legendary HOMAG quality and reliability.

Choose between a KAL 520 profiLine, which processes pre-sized workpieces in unfinished fixed dimensions or the KFL 520 profiLine, which is capable of component sizing, edge application and finish processing.

We are **YOUR SOLUTION**



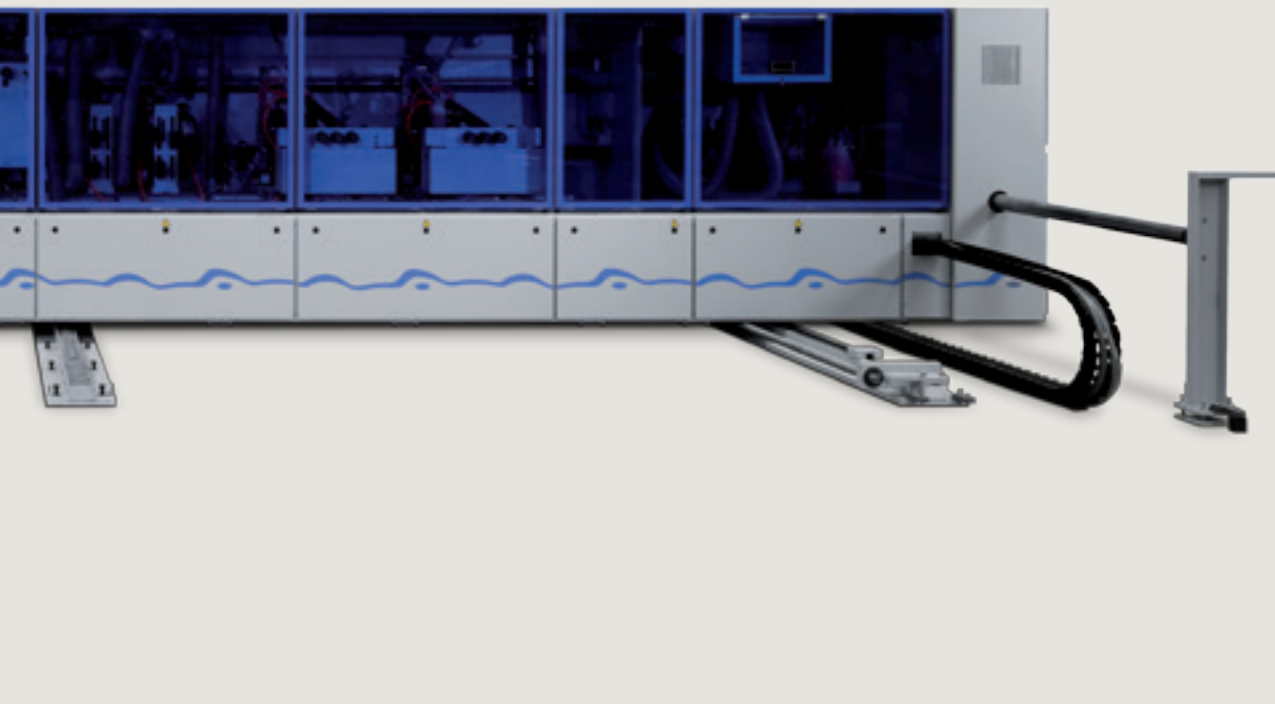

### The secret behind precision edges: The K 520 profiLine

Series K 520 profiLine edge banding machines offer flexibility, durability and excellent availability. They do it all: Panel sizing, profiling, edge application, processing, rebating and grooving a wide range of different workpieces. These include chipboard, MDF, coreboard panels, solid wood and plastics. Just as flexible: edge banding. Using hot-melt and PU adhesive or laserTec\*, solid wood, melamine, PVC, ABS or veneer edges can be applied in coil or fixed length material form.

### Double-sided machines type K 520 profiLine: Series furniture production

The classical application for double-sided machines and machine lines: medium to large-scale series production. These machines are distinguished by extreme high output and minimal resetting processes.

### Benefits of the basic machine

- Individual equipment with a variety of units
- Modular structure for a high level of flexibility
- A high standard of production quality coupled with a long service life
- Vibration-free working due to closed framework structure
- Optimum trimming results
- Quiet running and high workpiece quality due to transport chain with large ball bearing diameter

\* For patent-related reasons this may only be used in Germany with Rehau edges.

## The HOMAG K 520 profiLine series – as variable as your production needs

When it comes to processing your workpieces, flexibility is what counts. Which is why the machines of the HOMAG K 520 profiLine series are adjusted precisely to the varying widths of your workpieces. Choose from a wide selection of working widths from 1,000 to 3,500 mm in steps of 500

mm, whereby the minimum working width can be reduced longitudinally to 195 mm in the first machine of a line. If you are processing wide workpieces, we recommend using the automatic central support.



### **Longitudinal processing with KFL/KAL 520 profiLine**

Precise guidance: The workpieces are guided into the machine along the infeed fence, after which they can be cut precisely to size.



### **Transverse processing with KFL/KAL 520 profiLine**

The steplessly adjustable cams of the transport chain form the workpiece stop. This allows even softforming parts or profiled components to be reliably transported through the machine without damage. Depending on workpiece length, the cams can be extended to different distances between workpieces.

## Greater economy due to a long service life and optimum availability

With their sturdy design and with optimum care and maintenance, K 520 profiLine machines will go on working for generations. The roller block link chain transports all workpieces with pinpoint precision and ensures extreme

processing accuracy. The optimized chip and offcut disposal enhances machine availability and service life.



### Roller block link chain

All machines of the K 520 profiLine series are equipped with roller block link chain. This progressive technology ensures that all workpieces are transported with pinpoint precision and processed with extreme dimensional and repeat accuracy. Experience shows that the HOMAG block link chain is far less susceptible to wear than block link chain types with semi-circular rod.

The proof: Outstanding performance over a feed distance of more than 200 m even in dusty and abrasive environments.

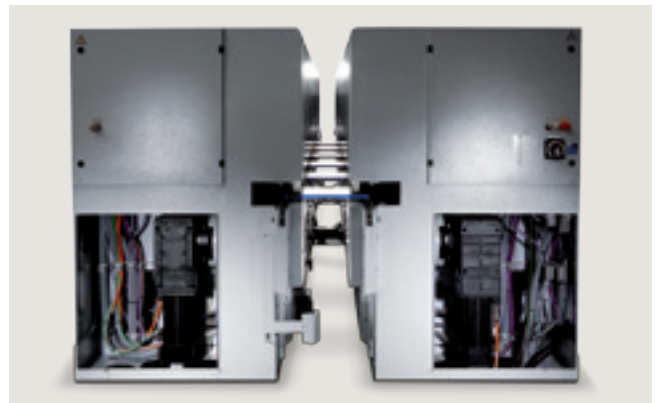

### Electronic shaft (option)

In double-sided machines, HOMAG offers a drive system on each side of the machine, the electronic shaft. This allows angle corrections to be performed from the control panel.

## Efficiency through series production

The reliable technology of the high-performance K 520 profiLine makes for more efficient panel furniture production. We provide the ideal solution to match your requirement. At HOMAG, production lines are specifically

designed, installed and commissioned for you by your own personal team. Because the networking of individual processing machines and material flow systems is a complex task.

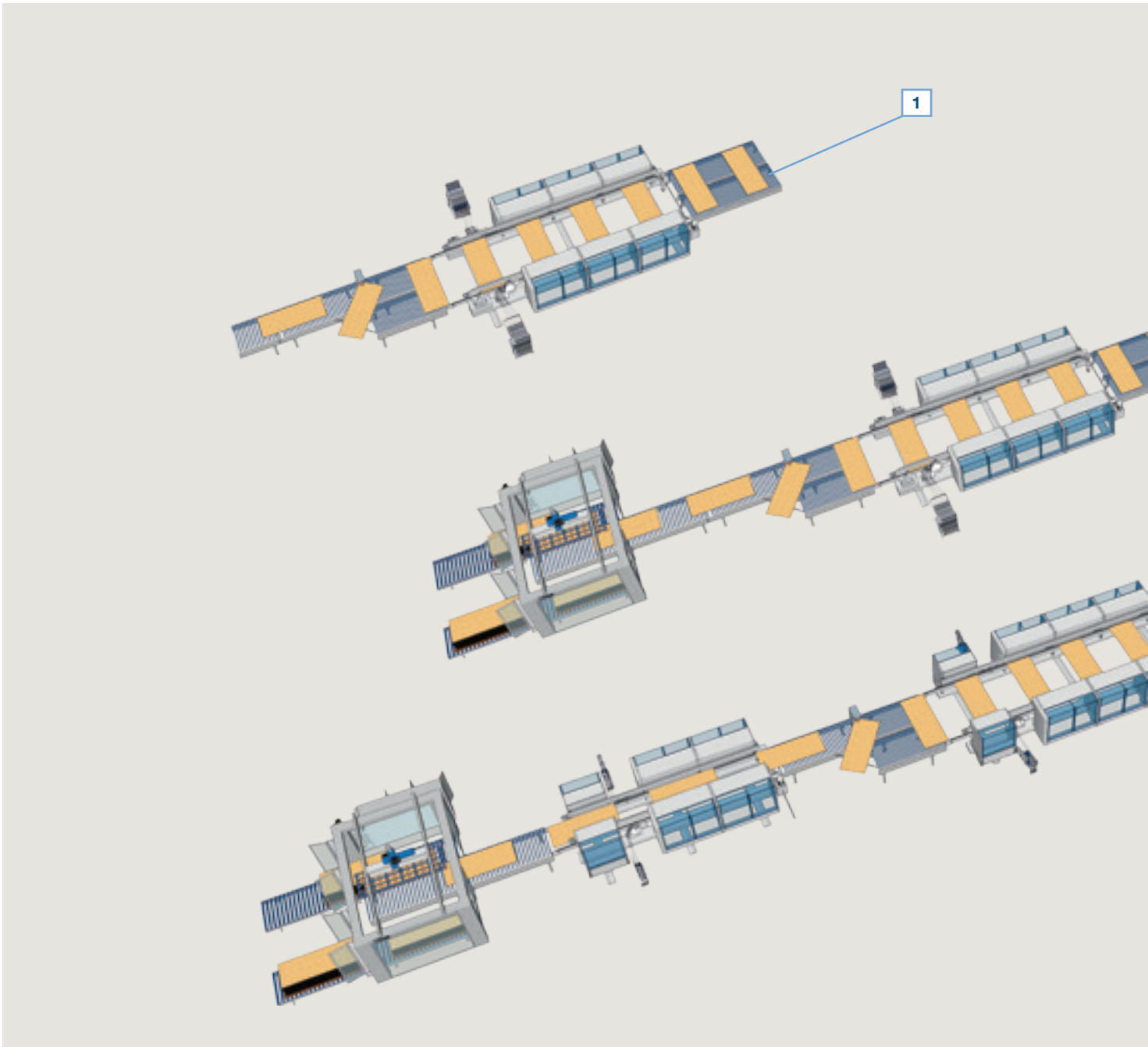



How you use the K 520 profiLine is determined by the capacity.

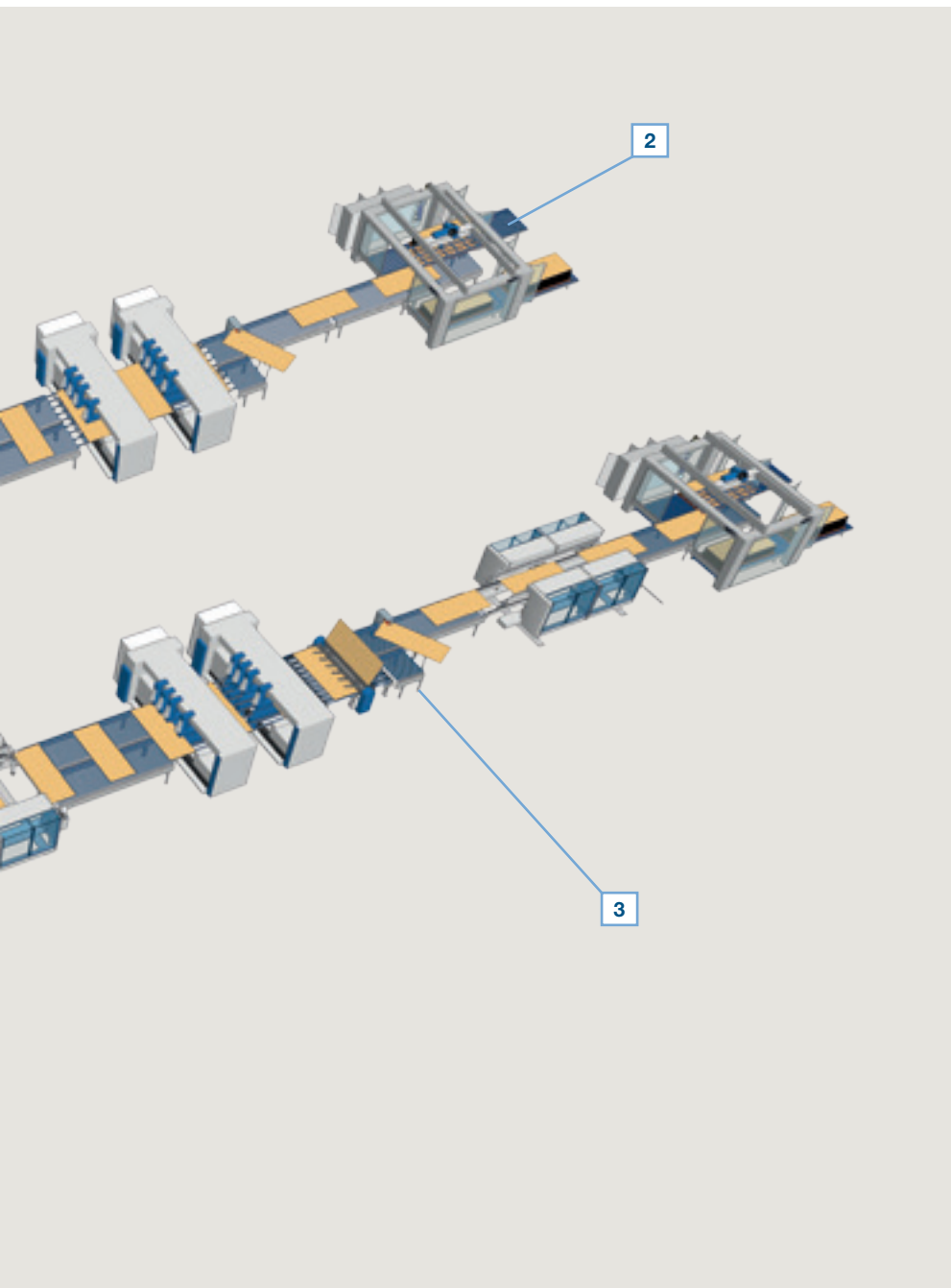
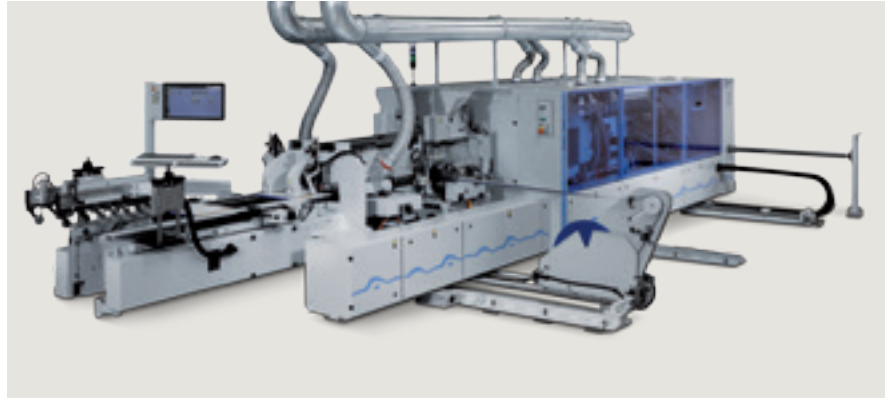

**1 STANDALONE MACHINE**

**2 SHORT MACHINE LINE - FOR MEDIUM CAPACITIES**

In this example, the workpieces are processed longitudinally and transversely in two work steps, with return transport of the stacks. Feeding and stacking systems as well as rotary stations to change from longitudinal to transverse format or vice versa to permit an automatic production process.

**3 PRODUCTION LINE – HOW YOUR PRODUCTION LINE COULD LOOK TOMORROW**

For the longitudinal and transverse processing of workpieces in a single pass for medium to large-scale series. Including feeding and stacking systems, throughfeed drilling machine and dividing saw.

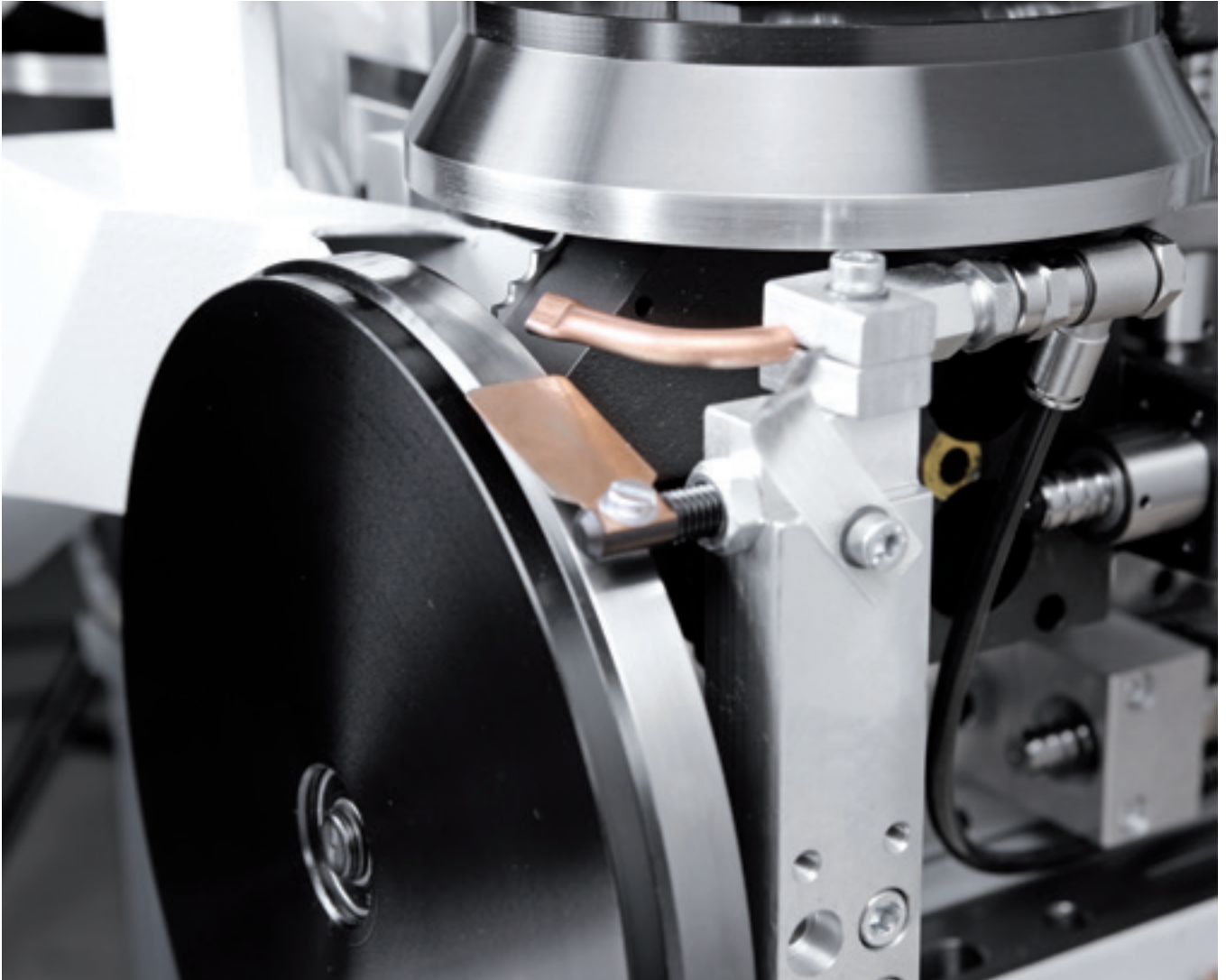

## Our range of modular units – always up to date

A wide range of different units is necessary to cope with varied processing operations. An extensive choice is available from our proven range of modular units. By continuously extending the offered functions, we ensure that you have the right solution available to cope with changing trends. Let us give you an impression of the processing units available, for

everything from panel sizing, gluing, zero joint technology and snipping to profile trimming, grooving and finishing. Their extreme precision and state-of-the-art technology will boost the flexibility and efficiency of your production.

## Sizing units – your requirement, our solution

HOMAG hogging units are true professionals when it comes to workpiece sizing. Whether coreboard panels, coating ply

overhang or transverse veneer – HOMAG plants are happy to cope with whatever you throw at them.

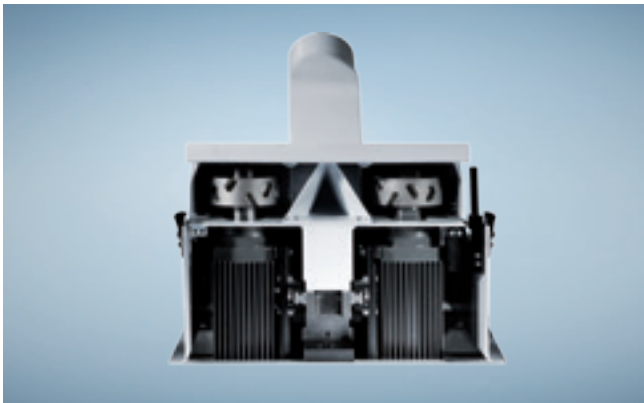

### Jointing trimming

This unit permits a high level of processing precision, is extremely hardwearing and is also designed to ensure an above-average service life. The tool diameter is 125 mm.

- Standard feature of KAL.

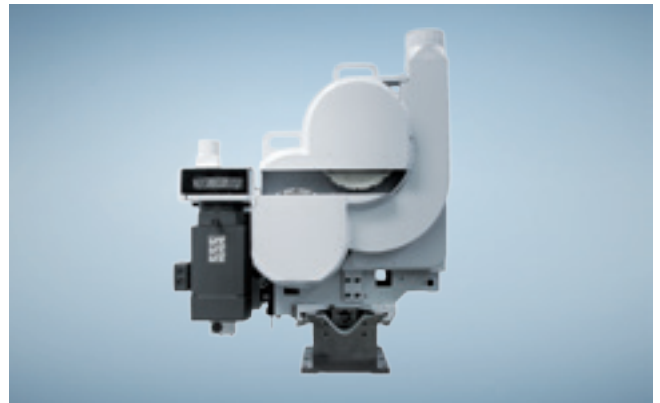
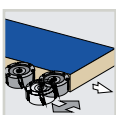

### Compact double hogger KD11

High-performance 6.6 - 11 kW motors permit the safe, splinter-free hogging of greater processing allowances. The KD11 unit performs sizing operations in the longitudinal and transverse direction with three motors. The tool diameter is up to 250 mm.

- Standard feature of KFL.

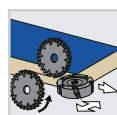

## Trimming operations – a tidy performance

The output speaks for itself: HOMAG trimming units allow you to rebate, groove and profile – optionally also with

tracing. We will take care of unit fitting and automation just the way you want them.

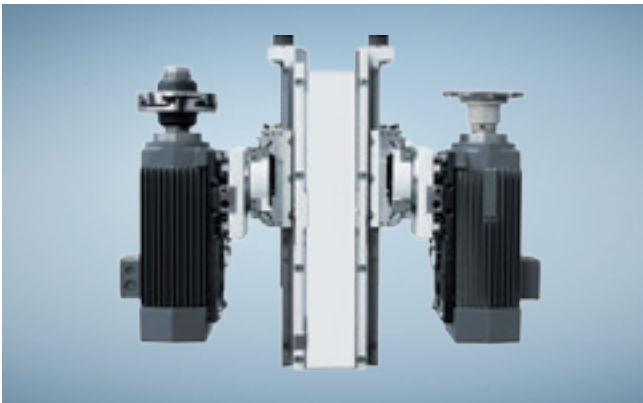

### Standard trimming unit SF20

This trimming unit permits top quality grooving and rebating. Depending on requirements, the machine can be fitted with a trimming unit upstream and two trimming units downstream from the gluing section.

- Automation to suit every need.
- Fast horizontal adjustment, vertical adjustment by means of servo axis.

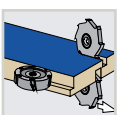

### SF21 grooving unit

For grooving, rebate trimming and profiling.

- Automation.
- Stepless horizontal and vertical adjustment by means of axes.

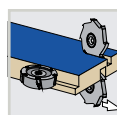

## Gluing units – reliable hot melt glue application

HOMAG gluing units are the professional solution for a fast, positive-locking glue bond. The standard gluing unit uses the pre-melt system. The heated glue roller ensures an optimum gluing temperature, while magazine height

adjustment offers scope for processing wide-ranging different workpiece heights. A simple, toolless quick changeover of the application unit allows other hot melt glue colors to be deployed with a minimum delay.



### Hot-melt gluing unit

For optimum glue application on the narrow surface. In case of changes to workpiece thicknesses, there is no need for resetting of the glue application roller.

### Quick-release clamping system for application unit (option)

For fast changeover of hot melt glue colors. This prevents mix-up of different hot melt glue colors.

- Standard feature of KFL.
- Optional feature of KAL.



### Melting unit with granulate tank

With a melting rate of 18–35 kg/h, there is always plenty of hot-melt glue available.

Optional: Even quantities of up to 45 kg/h pose no problem.

### PU melting unit

A range of possibilities are available for melting PU. Ask us.

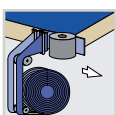



## The optical zero joint – the quantum leap in furniture production

Premium quality edge banding: Zero joint technology has fundamentally transformed furniture manufacture. The optical “zero joint” is the new quality standard for edge processing in the furniture and interior fittings trade. Using the HOMAG “laserTec – Next Generation” you can produce furniture with

premium quality edges. With this method, a special adhesive coating on the edging strip is melted by a laser beam and then pressed directly onto the workpiece.

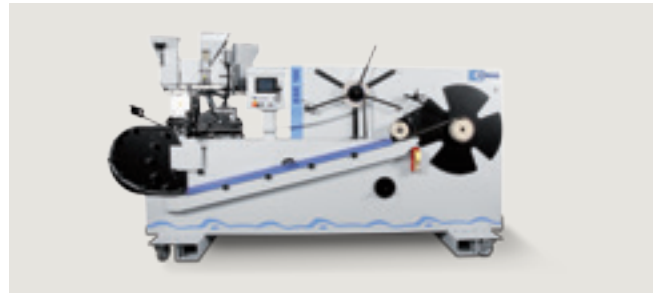
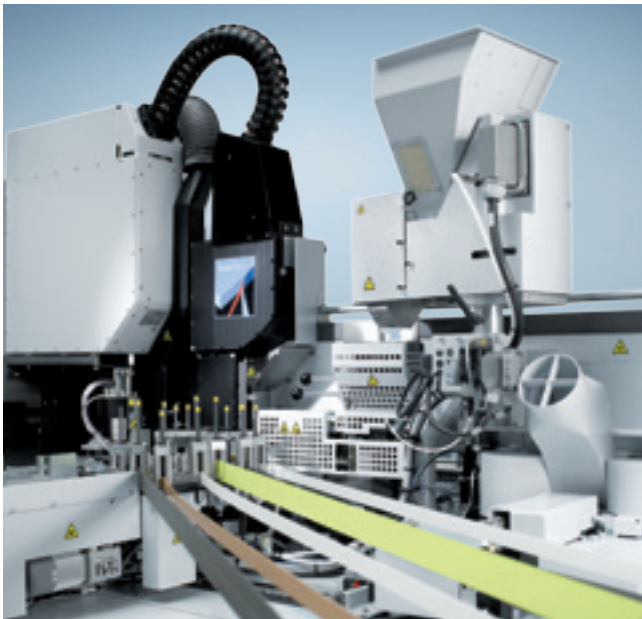

### For the entire laser edge spectrum

laserTec-Next Generation can be used to process all customary types of edging such as PVC, ABS, PP, PMMA, wood veneer or melamine. The laser-active layer is individually adjusted in line with product and customer requirements.

#### Optimum economy due to:

- Reduced rejects quota
- Simple operating processes
- Low additional costs
- Maximum level of availability
- Reproducible production parameters
- Resource-saving production
- Extreme production reliability

### Gain in flexibility

The KBE 100 edge precoat machine prepares conventional edge bands for processing with laserTec. For this, coils of the required edge decor are unwound in the KBE 100, coated with special adhesive, dried / cooled and rewound. This means that any optional edge band with the required decor finish can be made available immediately for processing with laserTec. This helps furniture producers remain independent and flexible. Laser edges manufactured with a KBE 100 must not be used and/or sold in Germany for patent law reasons.

## Edge feed: Versatile and precise

Servo edge feed does more than just sound impressively high tech – it actually cuts out edging waste and so tangibly reduces piece costs. We have actually patented this precisely dimensioned edge feed system with its ultra-minimal

workpiece corner overhang – after all, it was invented by HOMAG. HOMAG offers you a wide edge feed spectrum, from single and dual-slot magazines right through to a changer with 12 or even more slots.

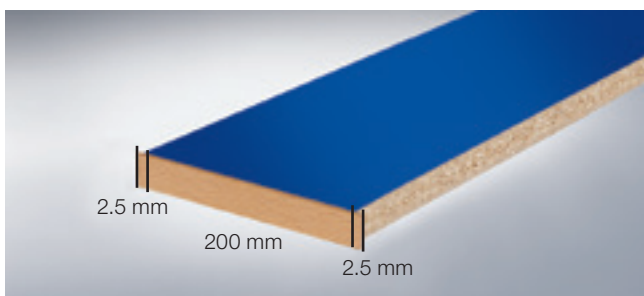
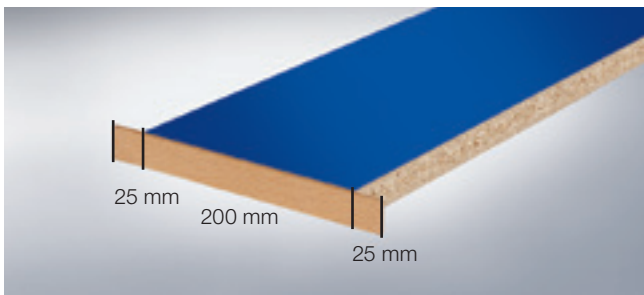

Above: Previous gluing technique

Below: Optimized gluing technique with servo edge feed

### Lower waste, fewer costs

The servo edge feed system feeds the edging material precisely dimensioned to the workpiece corner with only the barest minimum overhang. It permits leading and trailing edge precision of +/- 2–3 mm.



### Multiple edging magazine

The spectrum ranges from single and dual-slot magazines right through to changers with 12 slots or even more, allowing edges ranging from 0.3 to 3 mm to be processed with ease.

### Powered coil trolley

Prevents edge breakage at high feed rates.

### Edging coil length management (optional)

Reduced standstill periods resulting from missing edging material due to display and management of residual coil length.

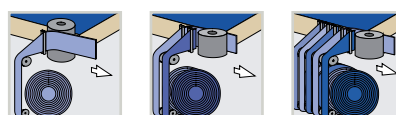

## Snipping units – the perfect preparation for trimming

Presenting a range of true team players. The snipping units prepare the workpieces perfectly for subsequent trimming operation. The face side can be snipped either straight or with chamfer. If the profile trimming team player is brought

in off the bench, then a piece of edging material is left in preparation for the optimum trimming result.

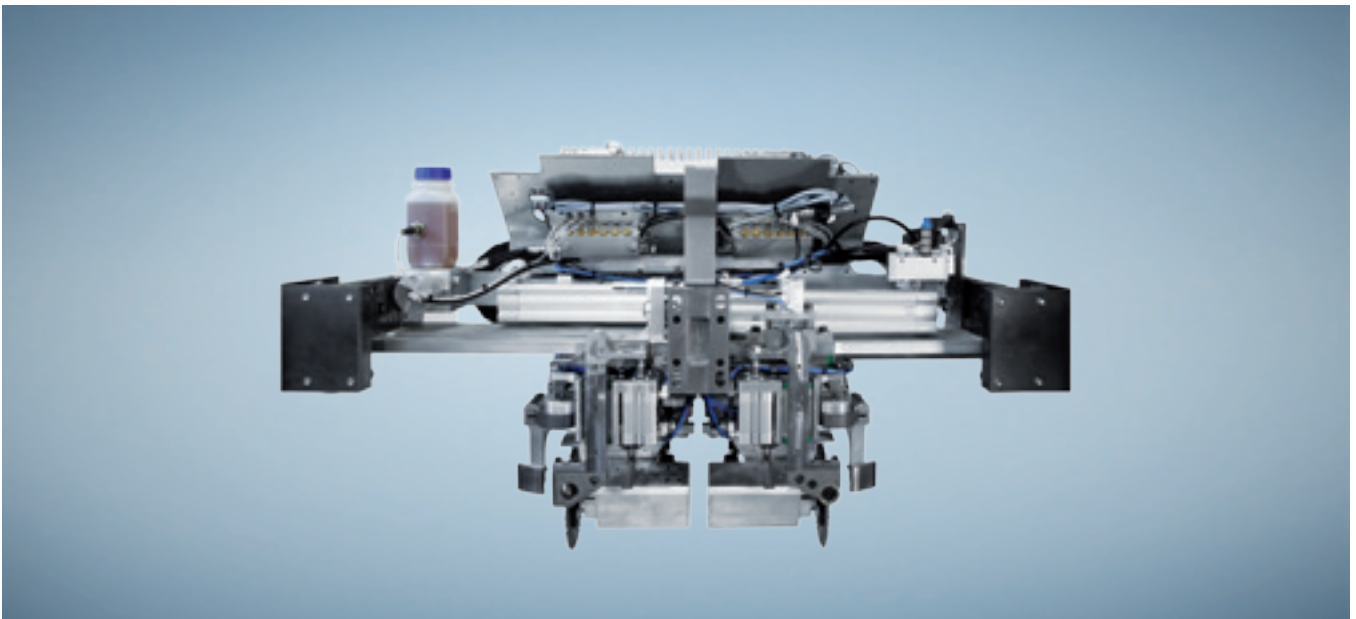

### Snipping units PK25 and PK30

For snipping the overhanging edges at the leading and trailing workpiece edge with stationary snipping stop to protect sensitive workpieces from damage.

The units are driven pneumatically.

### Use of the snipping units PK25 and PK30

For machines with feed rates of up to

25 m/min = PK25

30 m/min = PK30

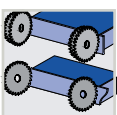

**Automation as standard**

Programmable chamfer/straight snipping motor adjustment for fast changeover between straight snipping and snipping with chamfer.



**Automation as standard**

For fast changeover between flush snipping (e.g. of solid moldings or inlay shelves) and snipping with overhang, e.g. for finish trimming with profile trimming unit.

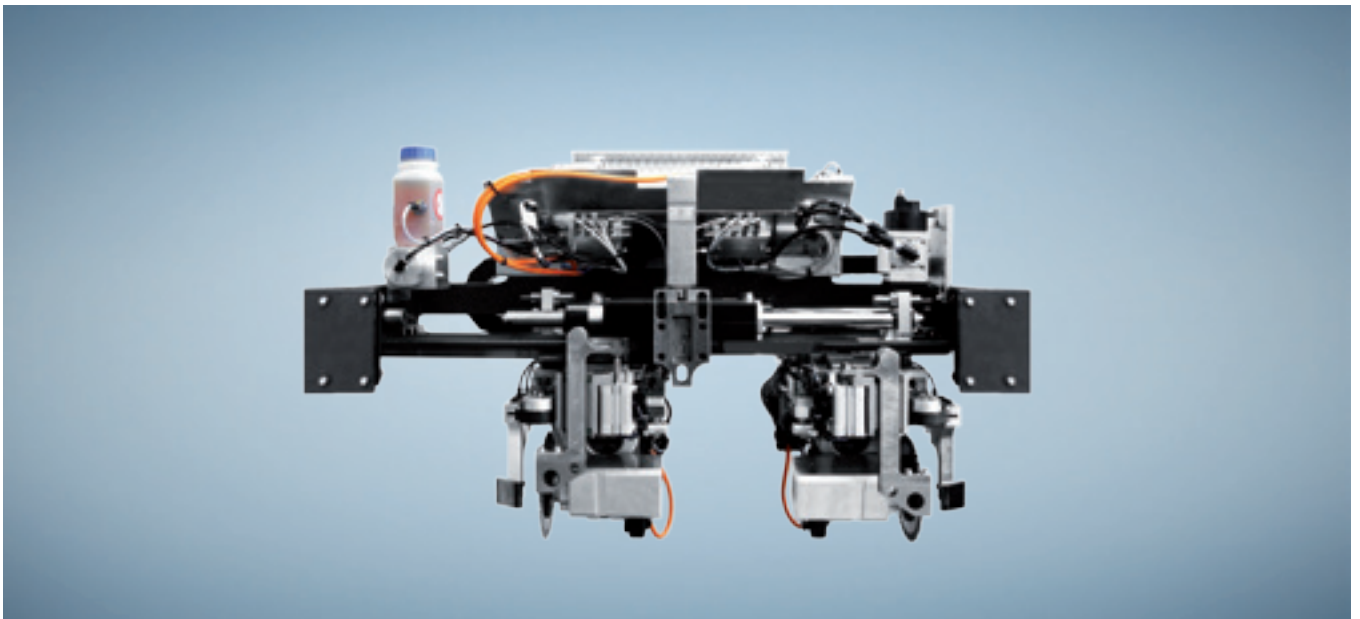

**Snipping units SK30 and SK35**

For snipping the overhanging edges at the leading and trailing workpiece edge with stationary snipping stop to protect sensitive workpieces from damage.

The units are driven by servo motor.

**Use of the snipping units SK30 and SK35**

For machines with feed rates of up to

30 m/min = SK30

35 m/min = SK35

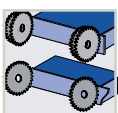

# Trimming – the solid basis for edge processing

HOMAG trimming units give the workpiece edge its required shape. Even using our basic units, practically-oriented solutions are guaranteed.

The rough trimming unit BF20 is ideal for rough trimming the upper and lower overhanging edge and trimming unit PF20 for trimming chamfers or radii at the edges.



### Rough trimming unit BF20

For rough trimming the upper and lower overhanging edge.

### Automation to suit every need

For automatic changeover from flush trimming to trimming with overhanging edge.



Flush



Overhang



### Trimming unit PF20

For trimming edge chamfers or radii.

Options: Stepless or pneumatic adjusting devices for the trimming motor. Trimming motor exchange using exchange units.

### Trimming unit PF20/21 flexTrim

For automatic changeover between different profiles, for instance R2 and R3.

### Multi-trimming unit MF21

For automatic changeover between different profiles, for instance chamfer 20°, R2 and R3.

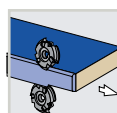
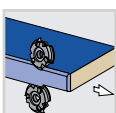
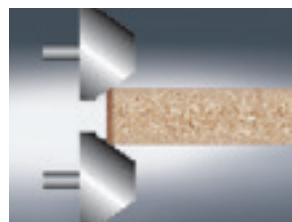



## Profile trimming – for rounded edges

HOMAG profile trimming units are true professionals when it comes to trimming. As a user, your job is to program any profile that takes your fancy: Then stand back and watch the extreme speed and precision of the expert execution. The

efficient mode of operation results in higher productivity. Our dual-motor profile trimming units permit both corner rounding and trimming of upper and lower overhanging edges.

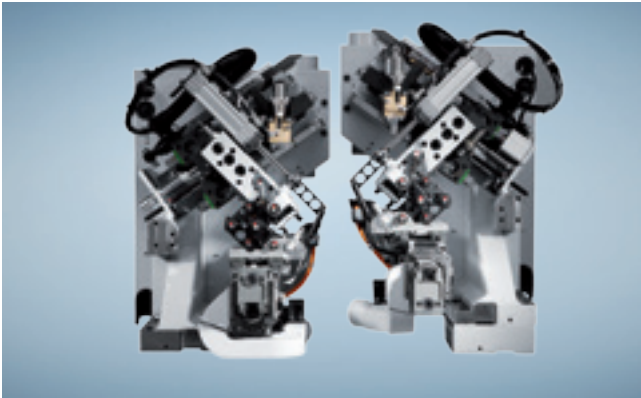

### Profile trimming unit FK11

For processing overhanging edges and trimming around the leading and trailing edge.

### Automation to suit every need

Chamfer/radius adjustment for fast changeover from for instance 0.4 mm to 2 mm edges.

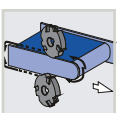
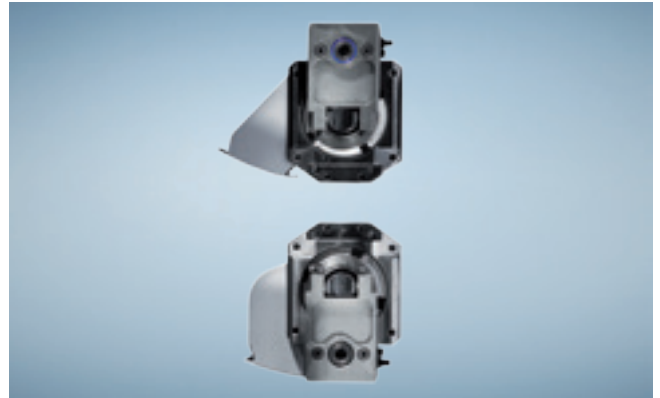

## Four-motor profile trimming tools – take anything easily in their stride

Are you looking for a unit for flush trimming the upper and lower workpiece surface? Then you have come to the right place. The four-motor HOMAG profile trimming units ensure reliable corner rounding even when processing veneer. The

flexTrim exchangers for the fast exchange of two profiles in the gap between workpieces can be mounted on profile trimming units FF32 and FF42.

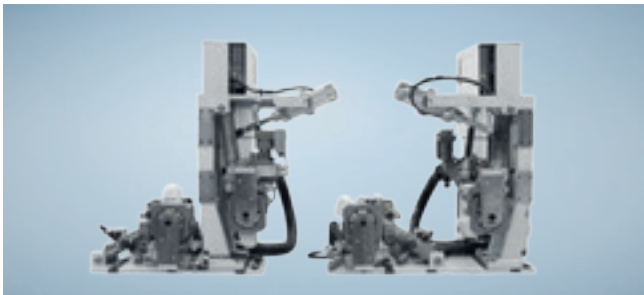
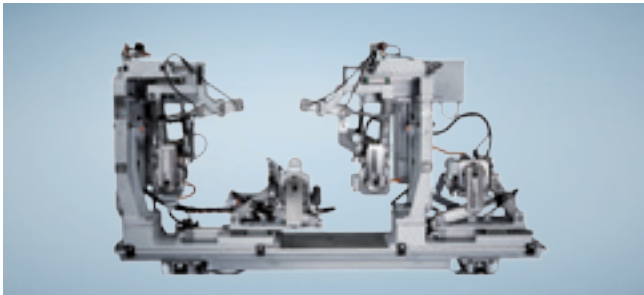

### Profile trimming unit FF42 (above)

For four-motor profile trimming at speeds of 35 m/min.

### Profile trimming unit FF32 (below)

For rounding top and bottom edges on the leading and trailing workpiece edges. By dividing the cut over four motors, each corner can be processed in synchronous rotation, so reducing the risk of splintering even with veneer.



### flexTrim

The flexTrim exchangers can be mounted on trimming and profile trimming units. They permit the fast exchange of two profiles within the gap between workpieces.

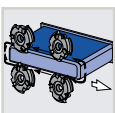

## Servo profile trimming – making you even more efficient

Expecting higher performance, greater contour variety and even higher quality? Then we recommend our servo profile trimming units FK30 and FK31 powerTrim. As the drive uses

modern linear motors, the movement sequence is controlled by the program when trimming around the edge band at the narrow surface of your workpieces.

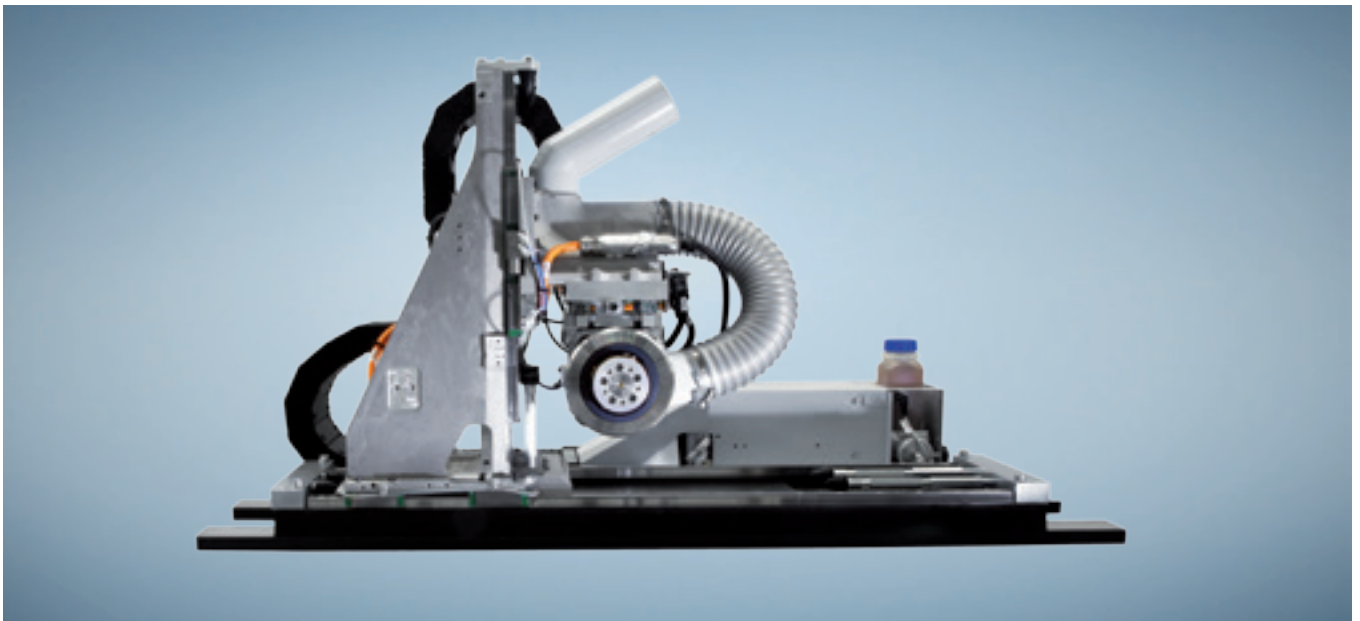

### Profile trimming units FK30 and FK31

For trimming around the leading and trailing edge.  
With servo motor-driven tracing axis for sensitive surfaces or softforming profiles.

### Use of the profile trimming units FK30 and FK31

For feed rates  
20 or 25 m/min = FK30  
30 or 35 m/min = FK31

### Automation to suit every need

- Adjustment to **three** different radii and chamfer
- Automatic adjustment of the tracing roller diameter
- Automatically adapted tracing force
- Automatically adapted speed

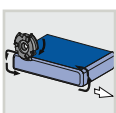

## Finish – all's well that ends well

The same principle applies to product as to running a marathon: Those who persevere to the very end will achieve their goal. For a perfect finish which has you running victoriously to the winner's podium, place your trust in

HOMAG. There are a range of possibilities available to make this happen. Depending on your requirements, choose the profile scraper blade PN20, the multi scraper blade MN21 or finish processing unit FA21.



### Profile scraper blade PN20

For smoothing trimmed edges to achieve an optimum appearance.

### Multi scraping blade MN21

For automatic changeover between a maximum of five different profiles.



### Finish processing unit FA21

Comprising a glue joint scraper blade for disposal of glue residues at the top and bottom of PVC edges and a buffing unit.

### Optimum surface quality

through precision adjustment of the glue joint scraper blade to  $\pm 0.01$  mm

- manually (as standard)
- automatically (optional)

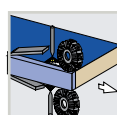
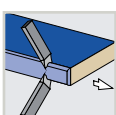

## Finish belt sanding – always on top form

Whether straight edges, chamfers or radii in solid wood.  
You can rely on our HOMAG belt sanding units – belt sanding

unit KS10, belt sanding unit PS20 or chamfer/radius sanding units PS41 and PS42.

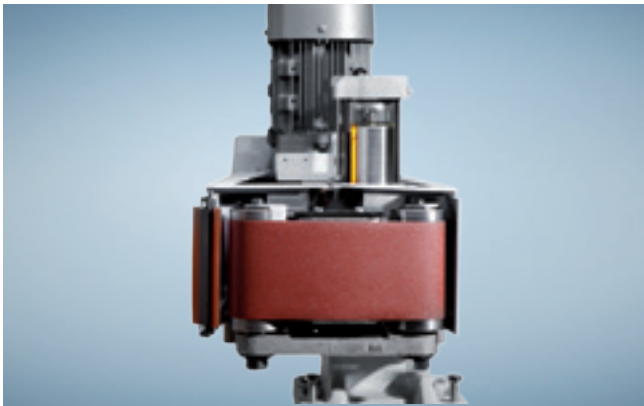

### Belt sanding unit KS10

For sanding straight veneer and solid edges including oscillation as a standard feature.

### Belt sanding unit PS20

For profile sanding using dual pad technology with two separately adjustable sanding pads.

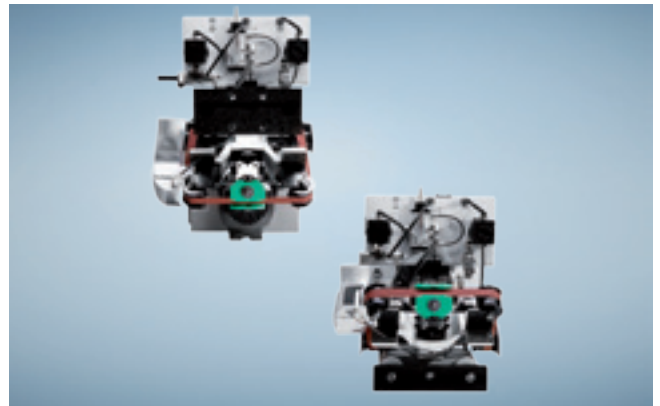

### Chamfer / radius sanding unit PS41 and PS42

For sanding chamfers and radii at the top and bottom of veneer and solid wood edges.

### Automation to suit every need

For traversing out of the work area and stepless adjustment to different edge thicknesses.

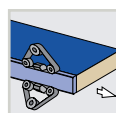
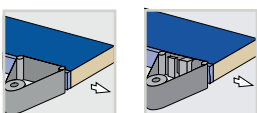





### Control with powerTouch

Using the widescreen format multitouch monitor, you control machine functions by direct touch contact. The ergonomically optimized design and an array of new help and assistant functions substantially simplify operation.



### Standardized

Standardized operating elements, software modules and standardized design characterize the powerTouch control system for HOMAG Group machines. This allows different HOMAG Group machines to be controlled in the same way.



### Ergonomic

Intuitive, direct control via the touch-sensitive touchscreen monitor.



### Evolutionary

Design and function united in one control system. The futuristic powerTouch machine control system is combined with state-of-the-art operating concepts used in smartphones and tablet PCs.

# powerTouch – the innovative control system: Simple, standardized, ergonomic and evolutionary

HOMAG machines are designed to make easy operation and reliable control a matter of course. Our innovative touchscreen operating philosophy combines design and function in a single control system.

The full HD multitouch monitor, ergonomic touch operation, simple navigation and the standardized user interface all enhance processing efficiency.

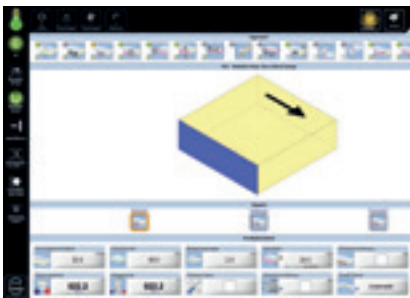

### Programming with woodCommander

User-friendly programming system using graphically supported input screens.



### Support via TeleServiceNet Soft

High-speed servicing and assistance through targeted fault analysis and support over the Internet.



### Evaluation with MMR Basic

The software evaluates the productivity of your machine and supplies usage-dependent maintenance notifications.

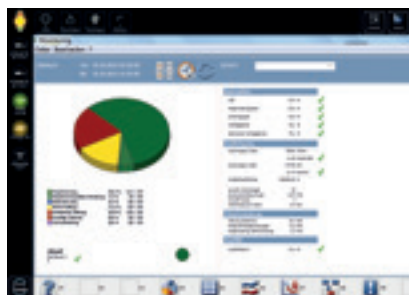

### MMR Professional (option)

The MMR Basic upgrade additionally evaluates shifts, analyzes error messages and permits a link to be created to the data evaluation center in the office.



### woodScout diagnostic system (Option)

Alongside error messages in plain text, woodScout also provides a graphic representation of the error location. In addition to the system's expert knowledge database, users can store their own troubleshooting solutions.

# Productivity – only as good as the control system

To increase the productivity of machine lines and production cells, HOMAG relies upon the PC53 production line control system. This allows more workpieces to be processed per shift, and offers scope for economical and varied production.

This not only cuts out operating errors but also allows a reduced staffing requirement. You may safely place your trust in our many years of experience with over 500 successfully installed systems the world over.



## Machine control

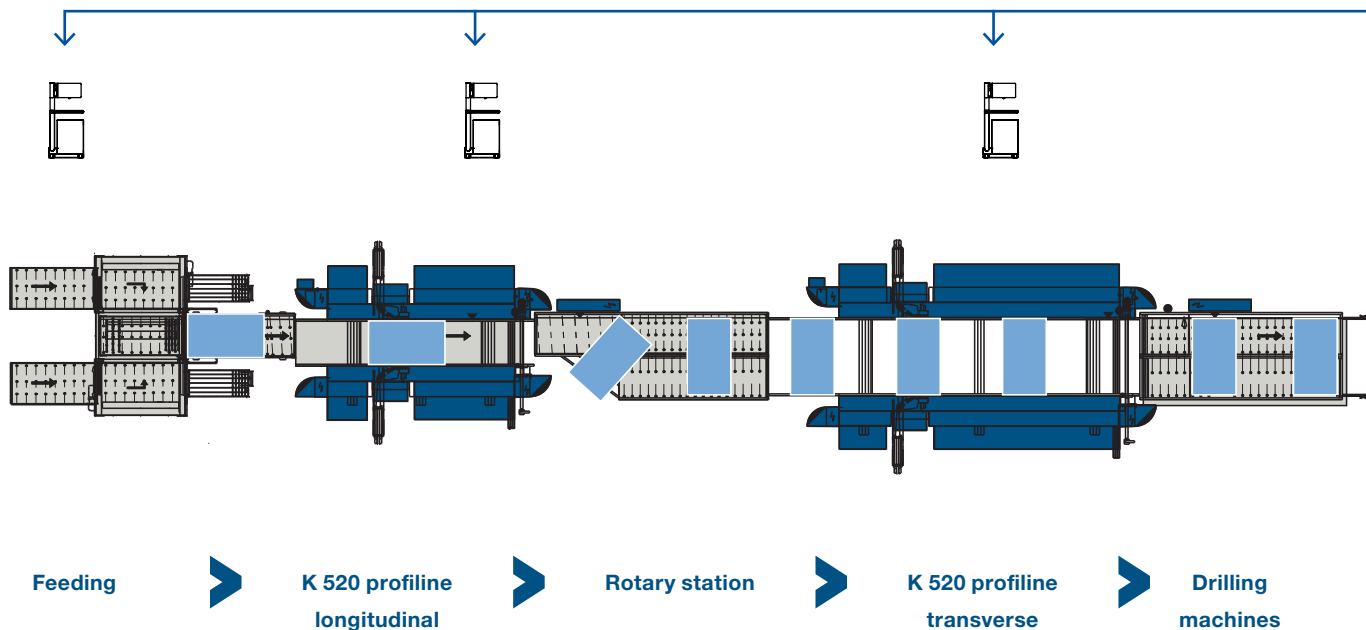

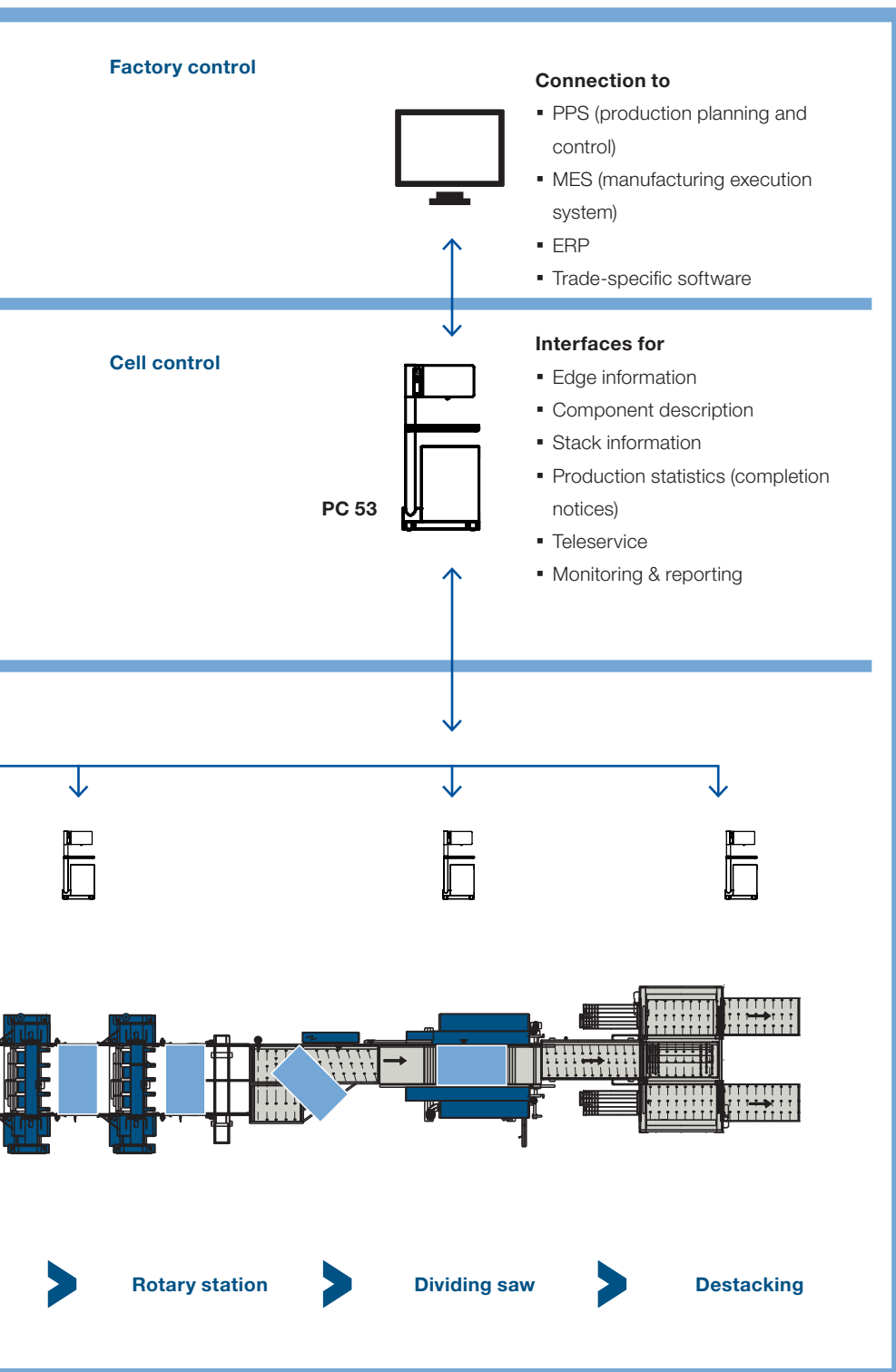

**Functional characteristics for improved performance\***

- Central production cell operation and monitoring
- Automatic data distribution in the production cell by part tracking and machine networking
- Production sequence control using list management
- Improved performance due to automatic cyclical output and calculation of the gap between workpieces
- Edge preview to reduce standstill times due to missing edging material
- Feedback

**Functional characteristics for data organization\***

- Central generation and management of component information in an MS-SQL database
- Component identification through automatic and manual bar code reading systems
- Component identification using labeling and ink jet solutions
- Stack management with integrated printout of stack accompanying documents

**Functional characteristics to enhance availability\***

- woodScout diagnostic system for central display of all line error messages at the cell master computer
- Fast, reliable troubleshooting and remedy using the worldwide teleservice

\*Some functional characteristics and interfaces are optional

## Feeding and stacking systems – compact and economical

Modern furniture manufacturing is inconceivable without high-performance logistics and process-reliable technology. Here, the HOMAG Group offers a comprehensive product range. End-to-end modularity makes these systems

astoundingly flexible in application. With their high capacity and long service life, feeding and stacking systems from HOMAG Automation are the solution for efficient material handling.



### **A smart material flow cuts costs and ensures process stability**

- Higher overall availability due to material handling optimization
- Space requirement for material in transit is reduced to a minimum
- High performance ratio due to optimum capacity utilization of all machines in the networked production process



### **Automation using compact solutions for reliable transport**

- Increased continuity and plannability of production due to high process reliability
- Greater flexibility through increased speed of the overall plant
- Optimal adjustment to the total value stream due to a secured material flow



**The number of parts per shift sets the pace**

Feeding (TBH) and stacking (TSH) systems are used in production chains with different performance categories to separate material stacks into single panels by means of a feeding system or to collate single panels into packages (material stacks) by means of a stacking system.

TECHNICAL DATA	TxH* version 25/12	TxH* version 30/12
<b>Cyclical output max. (parts/min)</b>	32 (18 cycles)	32 (18 cycles)
<b>Workpiece lengths (mm)</b>	250 – 2,500	250 – 3,000
<b>Workpiece widths (mm)</b>	195 – 1,200	195 – 1,200
<b>Workpiece thicknesses (mm)</b>	12 – 60	12 – 60
<b>Workpiece weight (kg)</b>	50	50
<b>Stack height (mm)</b>	1,600	1,600
<b>Stack weight (kg)</b>	3,500	3,500
<b>Layer arrangement (parts/lane)</b>	1 – 4	1 – 4

\* TBH as the feeding and TSH as the stacking system are shown jointly as TxH.



**Troublefree transport no matter what the panel**

An end to broken edges and optimum care of surfaces provide the assurance of material quality.

- Minimized waste and marks left by handling due to gentle-action workpiece handling
- Damage-free transport even of large thin parts
- Controlled separation of adhering workpieces using the stopping wall makes for secure production



**Cost savings and increased profit**

Automation using feeding and stacking systems minimizes wear of the material being processed.

- Effective layer formation when separating or collating workpieces
- Space requirement for material in transit is reduced to a minimum
- Automated, reliable material transport releases resources and enables more flexible personnel planning

## Rotary stations – taking a turn for the better

Rotary stations from HOMAG are used in production lines in which the workpiece orientation changes between

processing operations. The rotating cone takes care of gentle, precise workpiece movement.



### **TDL 310 – Rotation on one level**

Components with extreme dimensions are supported during the rotation process by lift-off rails.

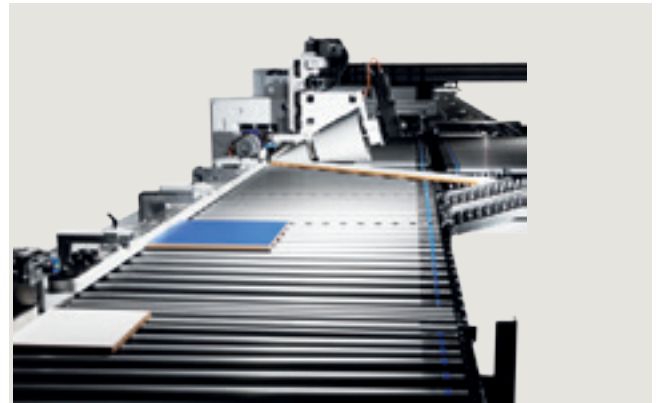

### **TDL 310 and 510 rotary stations**

TDL 310, longitudinal to transverse rotary station

TDL 510, transverse to longitudinal rotary station

Upgrading capability for:

- Batch size 1
- Lightweight panels
- Workpieces up to 80 kg or more

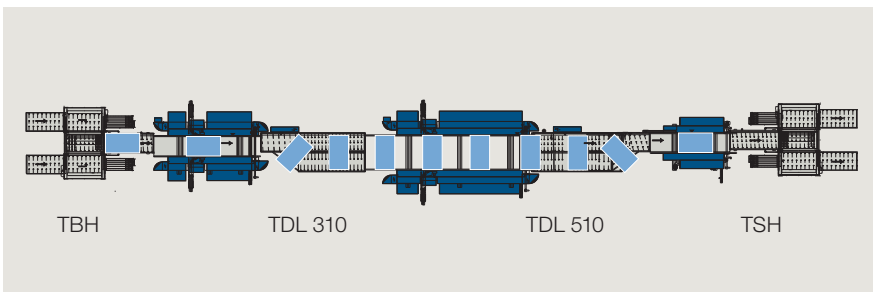

**Machine line with rotary stations**

Longitudinal to transverse and transverse to longitudinal

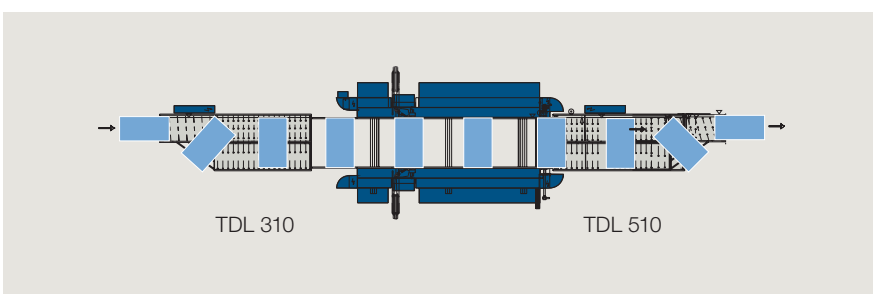

**Short line with rotary stations**

Longitudinal to transverse and transverse to longitudinal



## HOMAG Life Cycle Services

The sale of our machines comes with all-in optimum service backup and individual advice. We support you with service innovations and products which are specially tailored to your requirements.

With short response times and fast customer solutions we guarantee consistently high availability and economical production – over the entire life cycle of your machine.



### Remote servicing

- Hotline Support by remote diagnostics for control systems, mechanics and process technology, resulting in 85.2% fewer on-site servicing callouts
- Mobile applications such as ServiceBoard reduce costs due to rapid assistance in case of faults using mobile live video diagnostics and the online spare parts shop eParts



### Spare part service

- Round-the-clock identification, inquiries and direct ordering of spare parts at [www.eParts.de](http://www.eParts.de)
- Local availability of parts through sales and servicing companies and partners the world over
- Reduced downtimes due to defined spare part and wearing part kits



### Modernization

- Keep your machinery up to date and increase your productivity and product quality to prepare yourself today for the product requirements of tomorrow.
- We provide support in the form of upgrades, modernization, individual advice and development.



**HOMAG Finance**  
 – precisely the right financing

- We offer tailor-made financing arrangements for your plants and machines. Our advisory service goes hand in hand with our technical expertise over a wide range of issues. Your personal advisor will take care of the complete process
- The benefit for you: The ability to invest without delay in new technologies and remain financially flexible.

**1,200**  
 Servicing employees around the world.

**650**  
 processed spare parts orders per day.

**85.2%**  
 fewer on-site service callouts due to successful remote diagnostics.

**>150,000**  
 machines electronically documented in 28 languages in eParts.



**Training**

- Training tailored precisely to your requirements ensures that the optimum operation and maintenance of your HOMAG machinery by your own machine operators
- Courses include customer-specific training documentation complete with practical training exercises

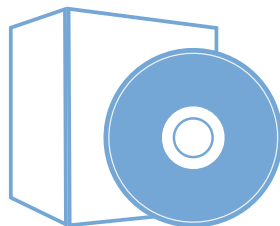

**Software**

- Telephone assistance and advice by Software Support
- Digitalization of your samples by means of 3D scanners saves time and money compared to new programming
- Subsequent networking of your machine outfit using smart software solutions from design through to production



**Field Service**

- Increased machine availability and product quality through certified servicing staff
- Assurance of the highest quality of your products by regular checks through maintenance / inspection
- Minimized downtimes due to unpredictable faults due to the ready availability of qualified technicians

# Technical data K 520 profiLine

## Width dimensions K 520 profiLine

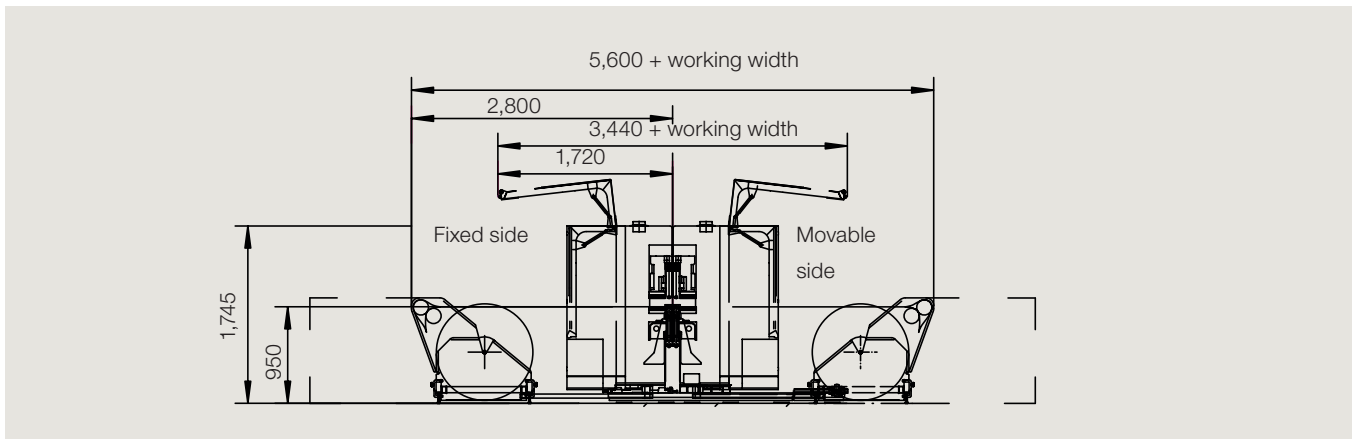

## Length dimensions K 520 profiLine

TYPE	KAL 525	5	6	7	8	9	10
Number of edging coils	2 / 6 / 12	x	x	x	x	x	x
Machine length (mm)		6,650	7,650	8,650	9,650	10,650	11,650

TYPE	KAL 526	5	6	7	8	9	10
Number of edging coils	2 / 6 / 12	x	x	x	x	x	x
Machine length, line (mm)		7,880	8,880	9,880	10,880	11,880	12,880
Machine length, standalone (mm)		7,650	8,650	9,650	10,650	11,650	12,650

TYPE	KFL 525	5	6	7	8	9	10
Number of edging coils	2 / 6 / 12 / 24	x	x	x	x	x	x
Machine length (mm)		6,650	7,650	8,650	9,650	10,650	11,650

TYPE	KFL 526	5	6	7	8	9	10
Number of edging coils	2 / 6 / 12 / 24	x	x	x	x	x	x
Machine length, line (mm)		7,880	8,880	9,880	10,880	11,880	12,880
Machine length, standalone (mm)		7,650	8,650	9,650	10,650	11,650	12,650

Content, technical data and photos are not binding in every detail. We reserve the right to make changes.



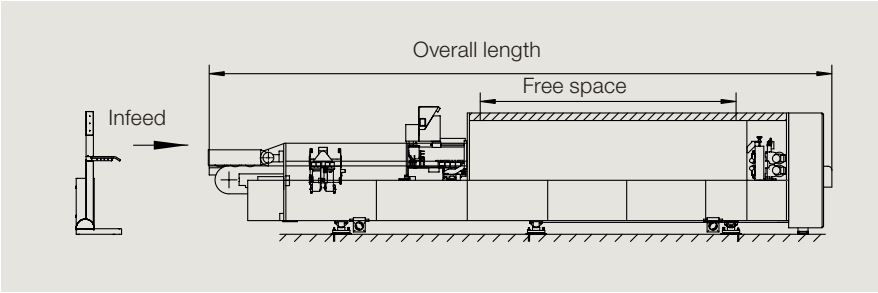

**KAL 525**  
Corresponds to machine 1 in a line.

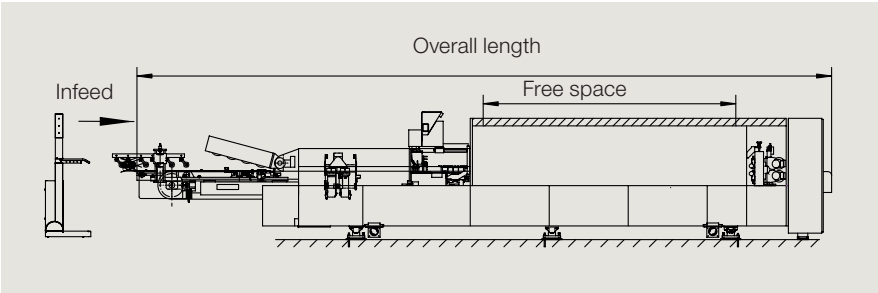

**KAL 526**  
Corresponds to machine 2 in a line or longitudinal/transverse machine in a short line or stand-alone machine with manual feed.

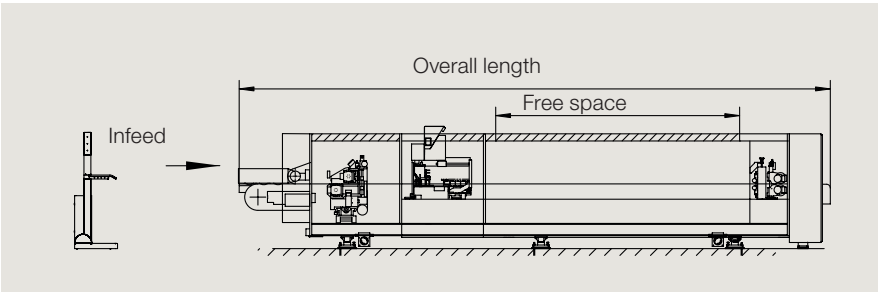

**KFL 525**  
Corresponds to machine 1 in a line.

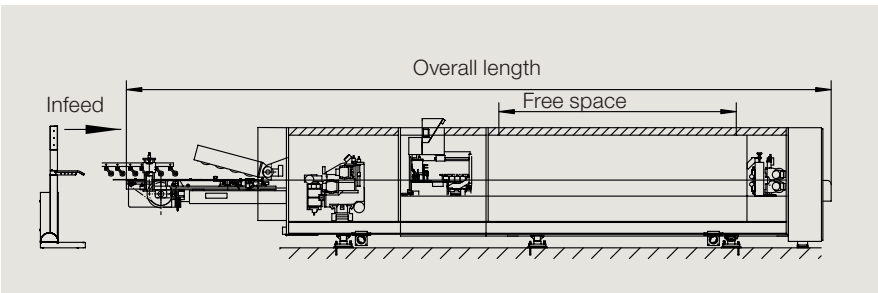

**KFL 526**  
Corresponds to machine 2 in a line or longitudinal/transverse machine in a short line or stand-alone machine with manual feed.

**HOMAG GmbH**

Homagstraße 3-5  
72296 Schopfloch  
Germany  
Tel. +49 7443 130  
info@homag.com  
www.homag.com



**Choose the Original  
Choose Success!**

For the Success of Original  
Technology  
A VDMA campaign



**K 520 profiLine  
and Optimat** high-  
performance machines,  
from individual to  
compact.