

# VAL ERIA

HIGH PERFORMANCE CALIBRATING/  
SANDING MACHINE

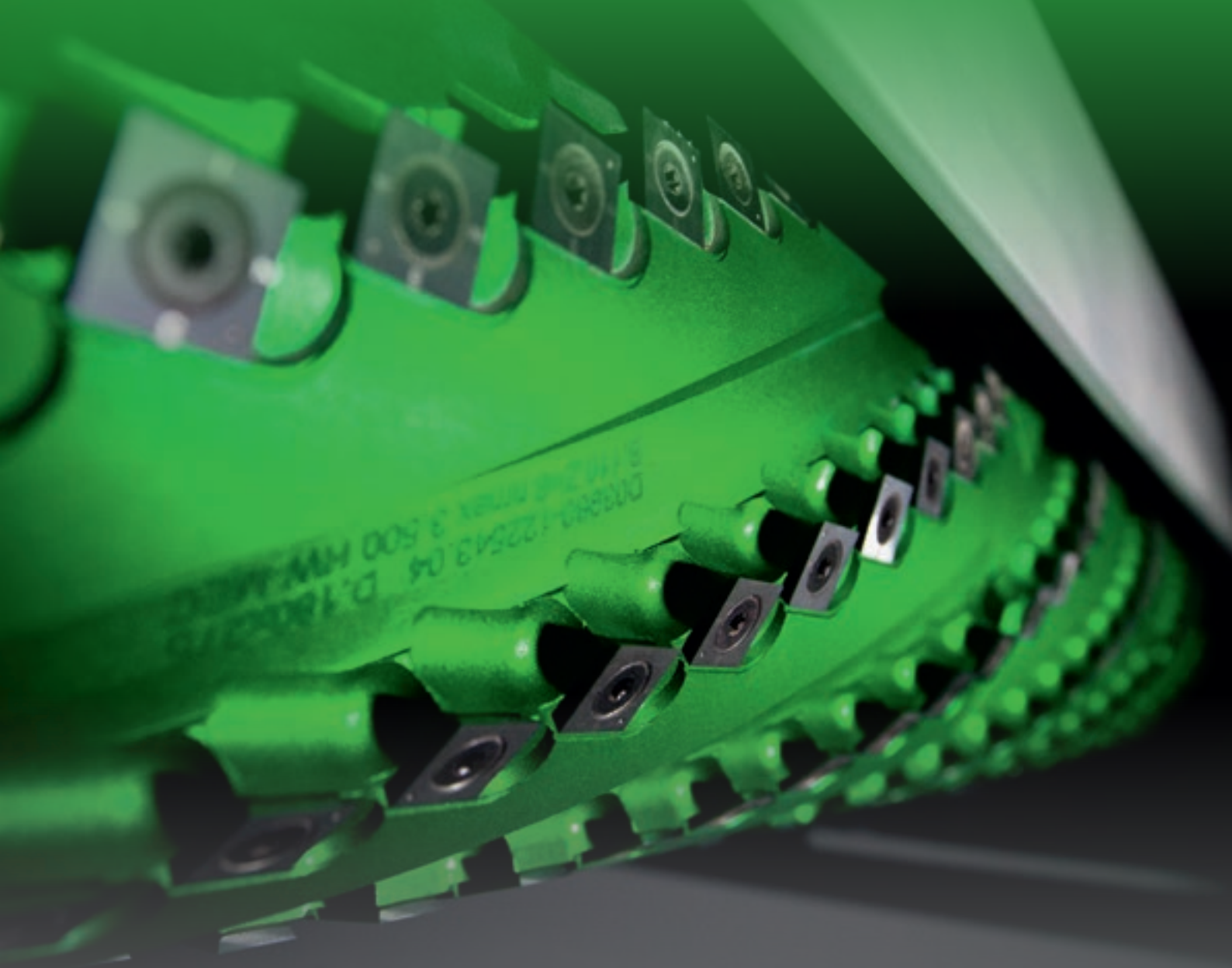

# HIGH PERFORMANCE FOR LARGE-SCALE INDUSTRY



## THE MARKET EXPECTS

the possibility to minimise **delivery times** on mass-produced items, guaranteeing **consistent precision and repeatability over time**.

## VIET RESPONDS

with solutions that offer extremely high levels of performance, achieved in accordance with the highest safety and reliability standards, ensuring maximum precision even on high-speed production lines.

**Valeria** is the calibration-sanding centre designed for large-scale industry applications. It is ideal for heavy-duty processing, allowing precision machining on high-speed production lines.



# VALERIA

- ✔ COMPLETE BOTTOM/UP PANEL MACHINING
- ✔ MAXIMUM ROBUSTNESS FOR EVEN THE MOST DEMANDING MACHINING OPERATIONS
- ✔ MACHINING PRECISION AND CONSISTENCY OVER TIME

# COMPLETE BOTTOM/UP PANEL MACHINING

A range of units available for quality and precision well above market standards.





**MACHINE CONFIGURATION WITH UP TO 4 LOWER UNITS AND 4 UPPER UNITS, ENABLING PANEL MACHINING TO BE COMPLETED IN A SINGLE STEP, FOR INCREASED PRODUCTION EFFICIENCY.**

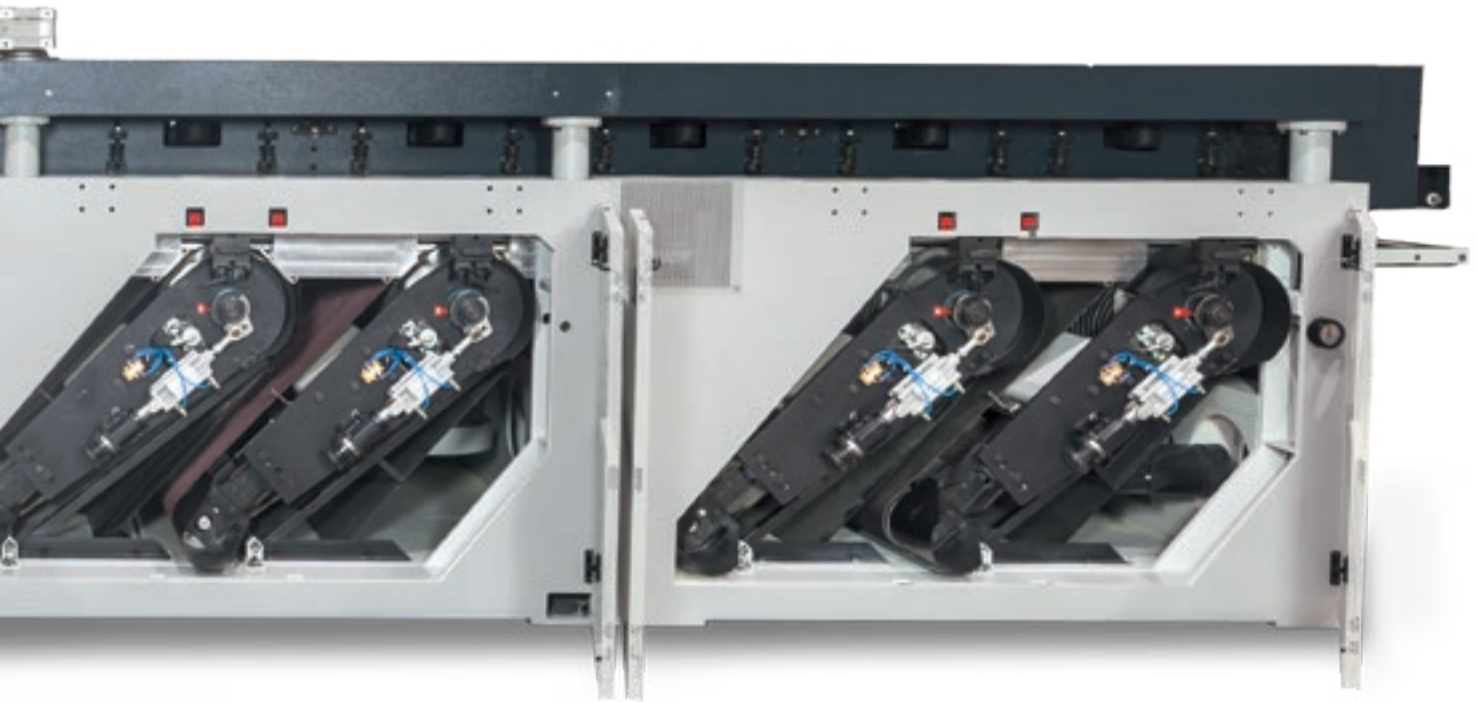

**THE INTRINSIC FEATURES OF VALERIA ENABLE IT TO WORK CONTINUOUSLY FOR 24 HOURS A DAY, 7 DAYS A WEEK.**

# TOP-QUALITY MECHANICAL SOLUTIONS TO MEET ANY REMOVAL REQUIREMENTS

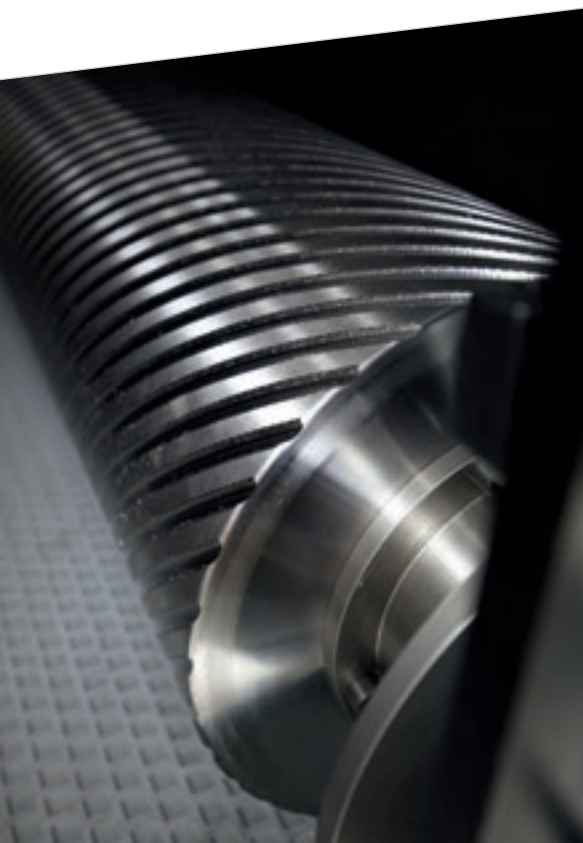

For calibration operations, the machine can be equipped with 320 mm cross-section 90 Sh steel or rubber rollers, and with motors of up to 75 Hp.



The **shoe presser** is used to ensure maximum calibration precision, or to flatten deformed or very thin panels during machining operations. The chrome anti-wear blade also enables panels with a painted surface to be machined.



**SOLUTIONS FOR CALIBRATION AND LARGE REMOVAL OPERATIONS**



Maximum machining precision, even with panels with significant differences in thickness, thanks to the sectioned shoe presser positioned at the entrance of the machine, which keeps the entire working width of the panel in contact with the belt. This component is always combined with the HPG planer unit.



The HPG knife unit is available for extreme removal operations. Together with other working units, it ensures maximum material removal and a perfectly flat surface.



**THE HPG UNIT IS RECOMMENDED FOR THE CALIBRATION OF BLOCKBOARD PANELS, AS IT ENABLES THE REMOVAL OF SEVERAL MILLIMETRES OF MATERIAL IN A SINGLE PASSAGE.**

# SOLUTIONS FOR SANDING UNFINISHED AND VENEERED PANELS

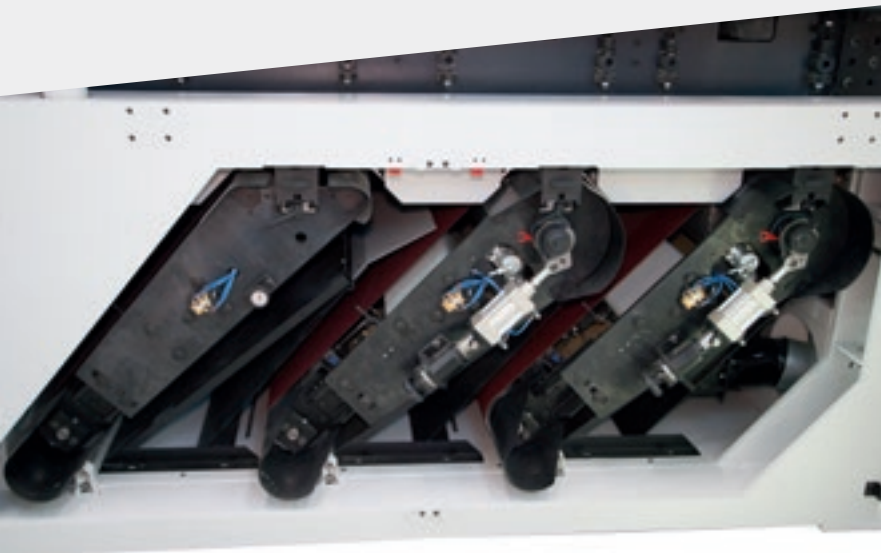

Soft rubber rollers with a diameter of 320 mm combined with buffer groups guarantee high quality standards when sanding unfinished and/or veneered panels.



The **Roller unit** is extremely precise and effective. Depending on the hardness of the rubber used and the roller's cross-section, the unit can be used to calibrate, sand or finish.

The **comparator device**, which features a resolution of 0.01 mm, is an extremely simple, precise and reliable reading system, designed to increase the accuracy of the positioning of the components of each roller unit on the upper machine model. This device can be placed on the roller to evaluate the working position of the unit and/or its shoe pressers, so that the height of the latter can be fine tuned.

**Valeria is the calibrating/ sanding centre that can meet the most diverse removal requirements.**



# OPTIMISATION OF MACHINING OPERATIONS



The **sanding pad group** is the ideal tool for performing smoothing and finishing operations with reduced surface roughness. Available with pneumatic or electronic pad. The sectioned **electronic pad** enables users to perform high-quality sanding operations thanks to the electro-pneumatic sensors that are only actioned on the panel's surface. The vast range of possible adjustments offers specific functionalities for different types of processing operations.

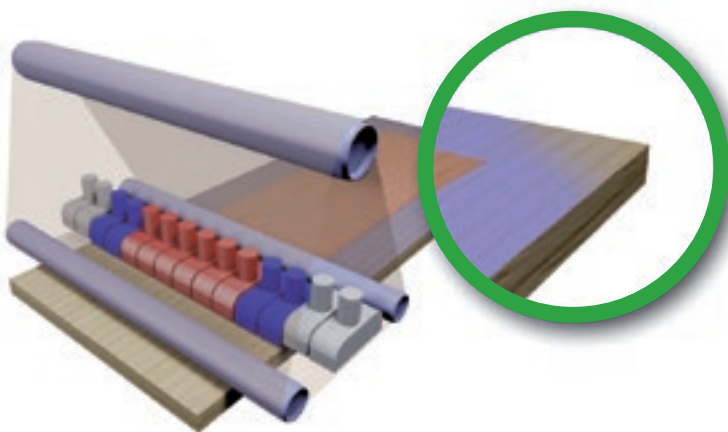

#### Save corner

All electric pads, with IPC controls, are fitted with the exclusive, patented Save corner function. The system limits the sanding time on the corners of the panel, thus preserving the most delicate portions of the panel's surface.

Thanks to the range of accessories it is equipped with, Valeria can ensure maximum machining precision that remains unchanged over time.

# HIGH PERFOR MANCE

## VALERIA TECHNOLOGY

Valeria is a centre designed for large-scale industry applications. It is ideal for heavy-duty processing operations, allowing precision machining on high-speed production lines.

A range of units available for quality and precision well above market standards. Valeria can be composed of a lower machine or an upper machine, or can be incorporated into an integrated production line with other mobile-head solutions from the Viet range, enabling both sides of the panel to be machined in a single passage, thus increasing production efficiency.



D03862-1225A3.04  
D. 18.02.2018  
B. 110 ZFB max 3 500 HW-AM-110



# MAXIMUM MACHINING PRECISION WITH NO COMPROMISES



The base has a monocoque frame in welded steel to house the upper and lower working units. The generous thickness of materials used guarantees the stability and durability of the entire structure.

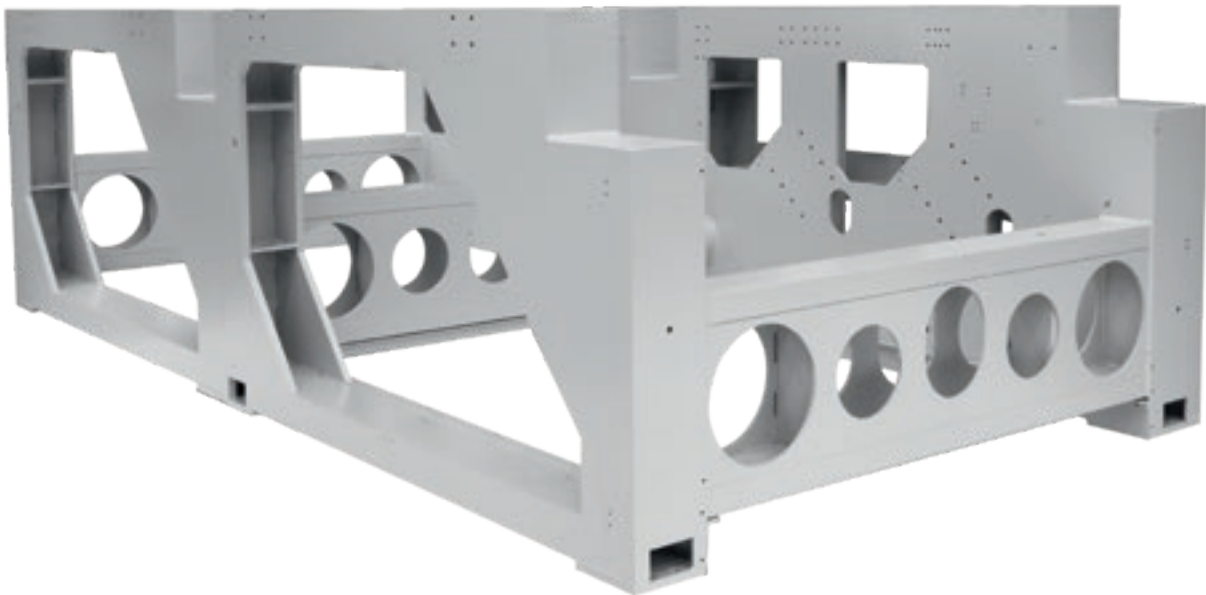

**THE HIGH-THICKNESS REINFORCED BEAMS GIVE THE STRUCTURE EXTREME COMPACTNESS AND STRENGTH, MAKING VALERIA ONE OF THE MOST PRECISE AND RELIABLE MACHINES IN ITS CATEGORY.**



# HIGH MACHINING ACCURACY AND STABILITY

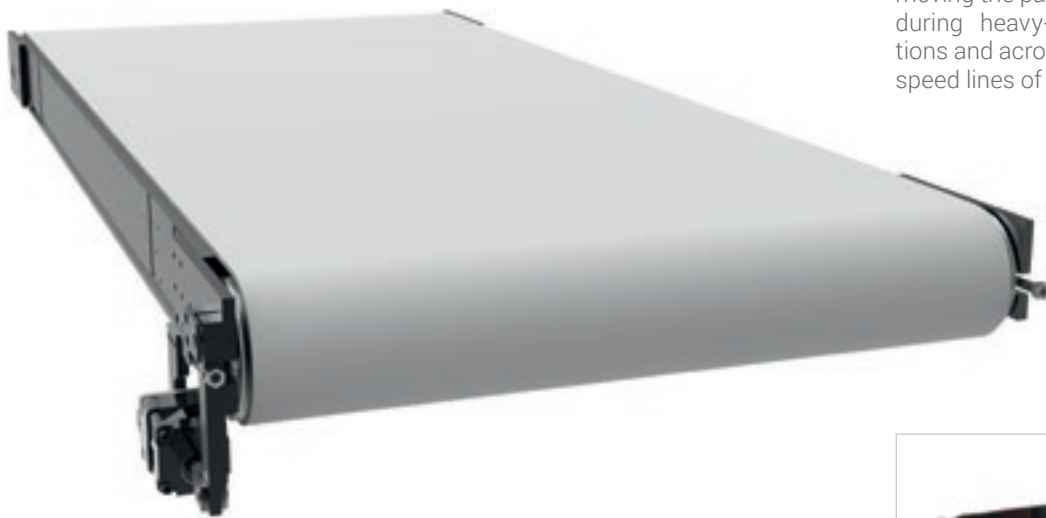

The work table, which is made from thick, wear-resistant steel, ensures high levels of endurance and accuracy and optimal machining stability throughout the machine's entire life cycle. Together with the wide belt conveyor roller, it ensures precision and efficiency when moving the panel being machined, even during heavy-duty machining operations and across several shifts, on high-speed lines of up to 60 m/min.

VALERIA IS ONE OF THE BEST-PERFORMING MACHINES IN ITS CATEGORY.



The use of large cross-section **rollers** makes the structure sturdy, ensuring precision for any positioning.



The machine can be fitted with a steel stop roller incorporated into the work table, positioned in line with the calibrating roller. Combined with the shoe presser systems, this ensures extreme precision of machined panels.

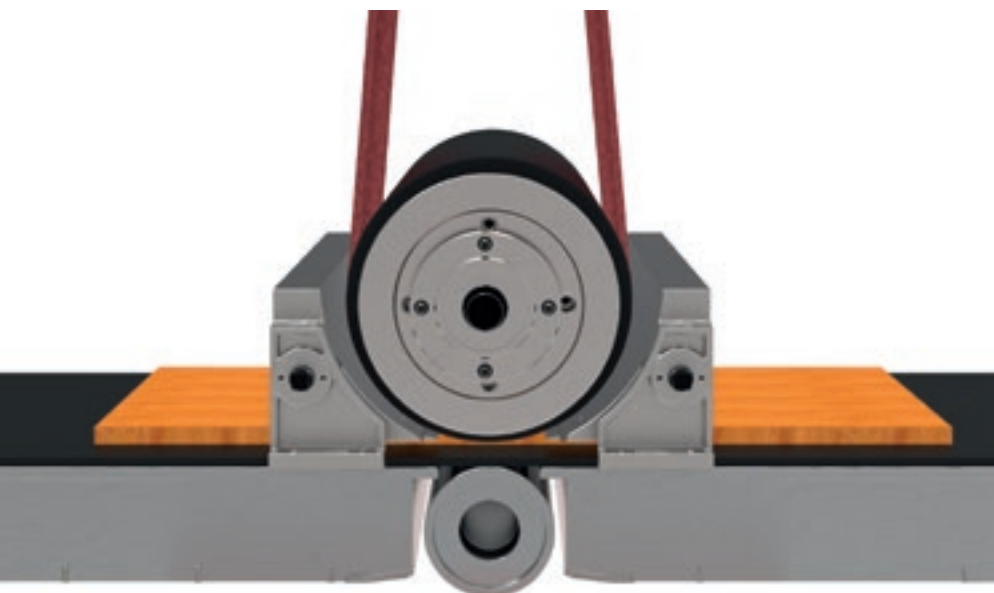

# HIGH PERFORMANCE FOR ALL PRODUCTION REQUIREMENTS

Valeria is a calibrating/sanding machine specifically designed for the most demanding machining operations, developed to meet the needs of companies with high production levels.

The machine can be equipped with up to 75 Hp of power for each unit, and guarantees excellent material removal performance, even at production speeds of up to 60 m/min.

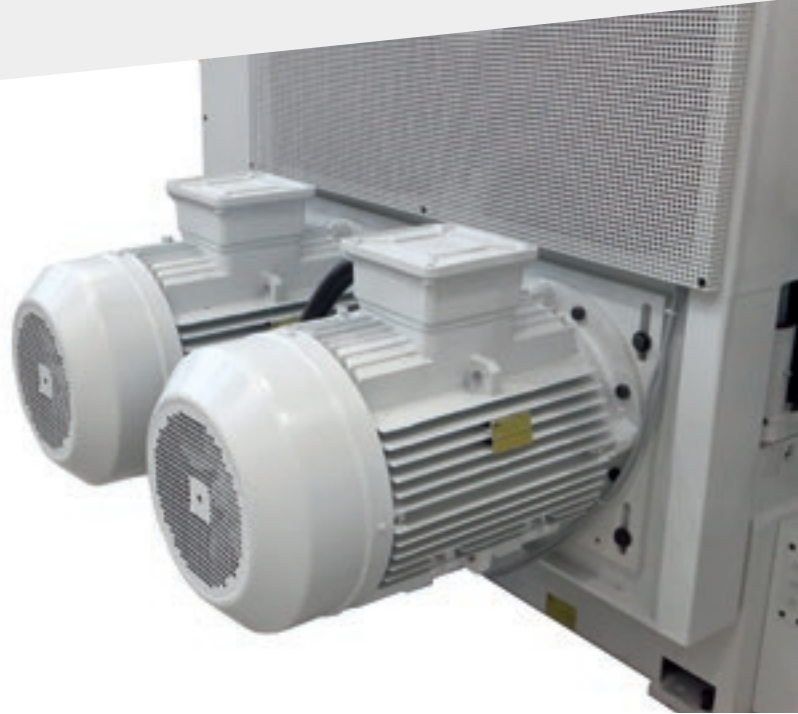

Valeria can be configured as a pure calibrating machine, maximising its performance; on the 4-unit model, for example, a total power of 300 HP can be installed.

# SIMPLICITY AND POWER

IPC is a range of control systems that are integrated into the machine, with icons that can be viewed on either a 8.5" or 15" touch screen monitor. This type of control system supports the management of all machine parameters, providing the operator with timely and intuitive information. The industrial PC processor provides control and feedback information to the machine in real time, making it extremely user friendly for the operator.



Sectioned pads management



Alarm checks



Belt wear

THE IPC SYSTEM IS THE HIGHEST EXPRESSION OF SANDING MACHINING MANAGEMENT TECHNOLOGY AVAILABLE ON THE MARKET.



# OPTIMAL PANEL CLEANING WITH A GREAT PRICE/PERFORMANCE RATIO



**A range of solutions that guarantee excellent finish quality of the machined panel.**

The **panel cleaning brush** can be fitted with bristles of different materials, making it ideal for deep cleaning the machined panels.

## **ANTI-STATIC BAR**

Positioned immediately before the rotary blower unit to remove the electrostatic charges generated on the panel during the process. Particularly suitable for machines incorporated into a painting line.



Active anti-static bar



Passive anti-static bar





The **orbital blower**, positioned at the exit of the machine, enables optimal cleaning of the panel's surface, edges and bore holes at the end of the sanding cycle.



The **oscillating linear blower** prevents the belt from becoming clogged, keeping the surface of the abrasive in excellent condition over time. This component optimises air consumption, blowing and oscillating automatically only during panel processing.



The **cam blower** ensures optimal belt cleaning, courtesy of its elliptical and asymmetrical movement. Particularly suitable during sanding of painted panels.

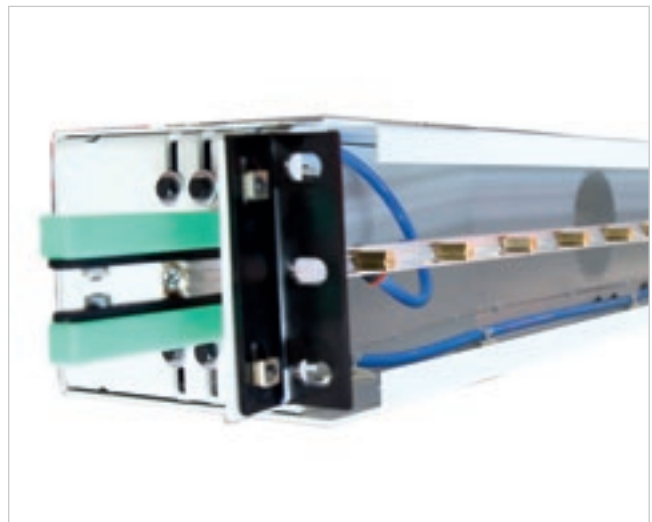

The **conveyor belt cleaning blower**, positioned at the exit of the machine, cleans the dust formed during calibration/sanding from the belt. Maximum cleaning performance with minimal air consumption.

**ESS**  
VIET ENERGY SAVING SYSTEM

#### Viet Energy Saving System (ESS)

With an ongoing focus on energy savings, the ESS system is one of the options available within the range of machines, and constitutes a series of accessories designed to minimise consumption.

# MAXIMUM SCOPE FOR INTEGRATION WITH OTHER MACHINES FROM THE VIET RANGE

The Valeria lower calibrating machine can be integrated with all mobile-head machines in the Viet range (fixed work table). Ideal for all production lines that perform different machining or finishing operations on the two sides of the panel.



Viet Valeria lower and Viet Opera 5 range



Viet Valeria lower 4 roller calibrating machine



THE ABILITY TO  
INTERFACE WITH  
OTHER MACHINES  
ALLOWS THE VARIOUS  
CONFIGURATIONS TO BE  
SIGNIFICANTLY EXPANDED  
AND INTEGRATED,  
ENABLING MACHINING  
OPERATIONS TO BE  
CARRIED OUT ON BOTH  
SIDES OF THE PANEL.

# PERFECT INTEGRATION WITHIN THE PRODUCTION FLOW

**Viet can provide specific solutions which are tailored to meet your specific productivity, automation and space requirements.**

The lower/upper lines are available as part of a compact solution or with intermediate transfer or transfer at the entrance and/or exit of the machine, which can be removed when changes to the process are implemented by the customer. Specifically, the intermediate transfers play an important role when machining large panels.

In the in-line configuration too, the machine can be fully managed via a single control, thanks to the 15" IPC interface positioned on an electrical panel which is separate from the machine, or on a mobile control trolley.



Viet Valeria lower and Viet Opera 5 range





Viet Valeria upper calibrating machine with trolley



# THINKING BIG

Valeria is designed to meet the needs of large companies. With this solution, it has never been so fast and efficient to machine large panels.



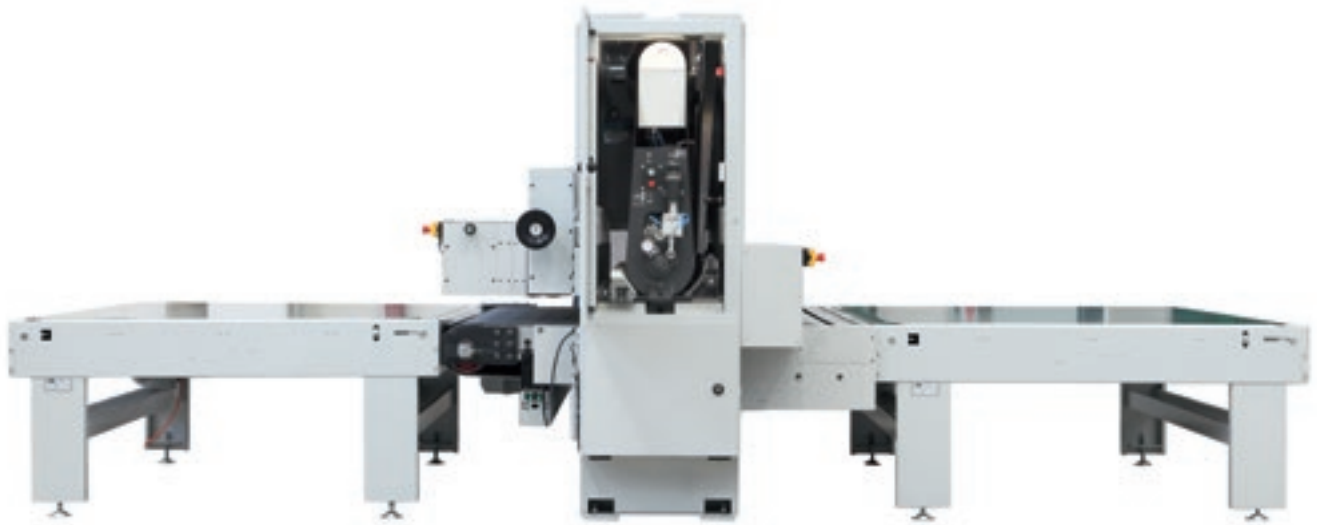

Valeria is equipped as standard with a thick, wear-resistant fixed steel work table which guarantees precision and sturdiness for any type of machining operation.

The standard solution for mobile-head machines offers a working height of 160 mm. As an option, the machine can be customised to enable panels of up to 500 mm thick to be machined.



# SPECIAL CONFIGURATIONS

Possibility to develop tailor-made solutions to meet the most precise requirements.



Each component of the Valeria machine enables the same degree of finish reliability and repeatability to be achieved, even on custom machines.



Lower brush detail.

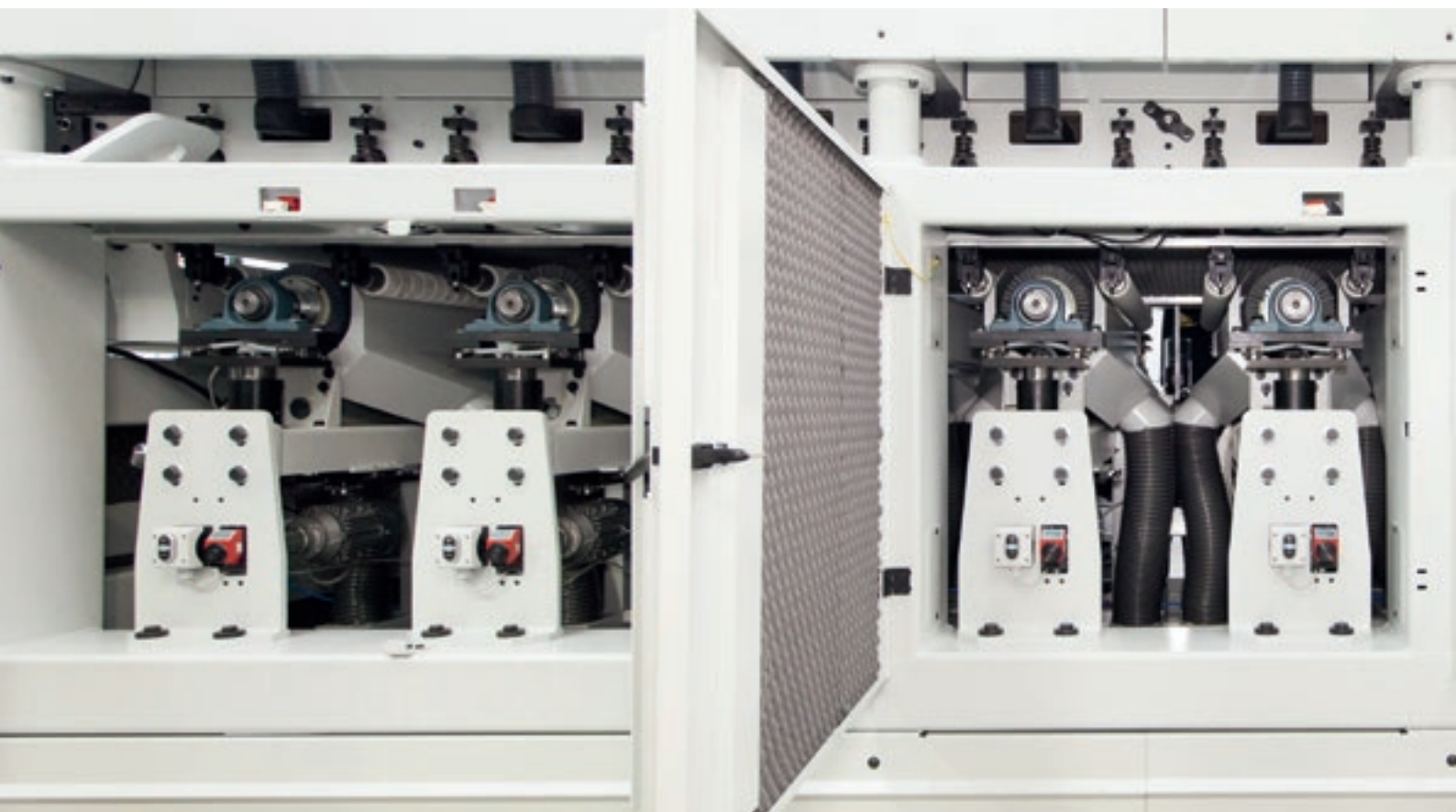





External view of the special Valeria lower calibrating machine with 8 brush working units.

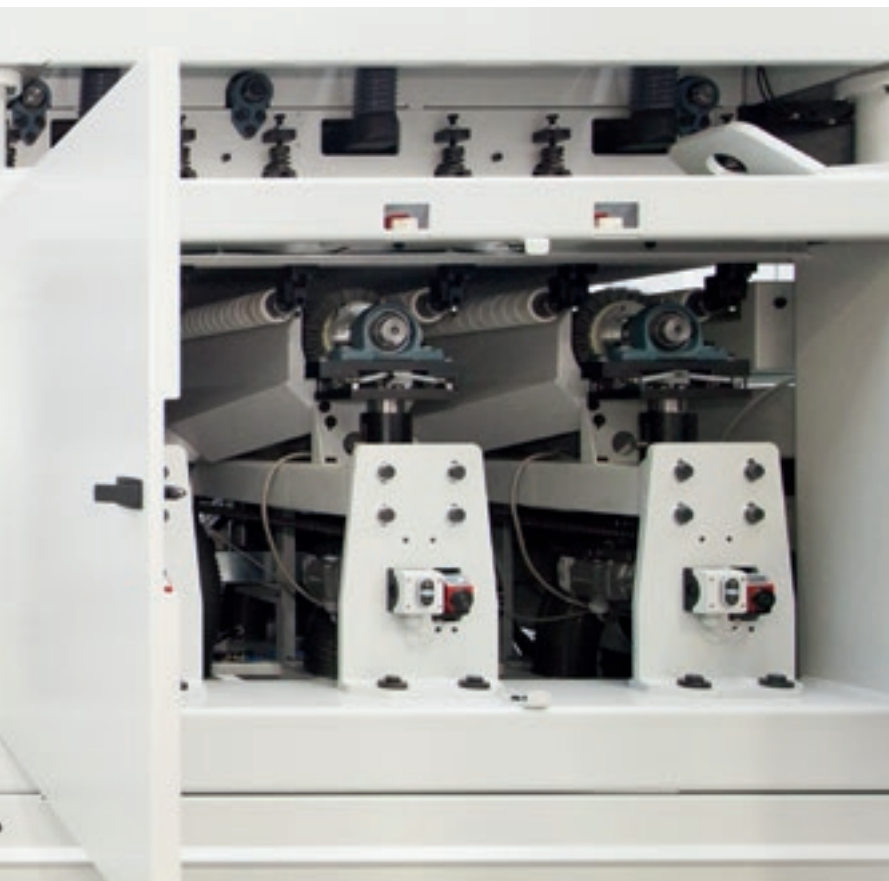

Roughing machine version with lower units.

# TECHNICAL SPECIFICATIONS

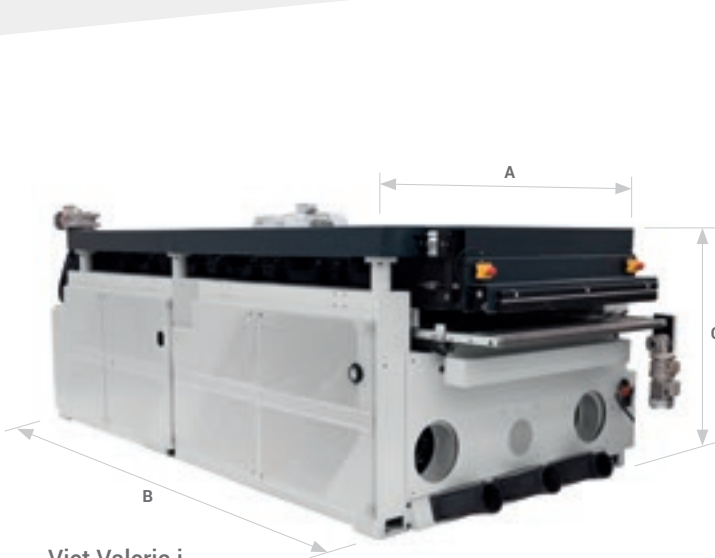

Viet Valeria i



Viet Valeria s

		VIET VALERIA - 1i	VIET VALERIA - 2i	VIET VALERIA - 3i	VIET VALERIA - 4i
A 1100 - 1350 - 1600	mm	2750 - 3000 - 3300	2750 - 3000 - 3300	2750 - 3000 - 3300	2750 - 3000 - 3300
B*	mm	3000	3600	4300	5200
C 2620	mm	1850 - 2010	1850 - 2010	1850 - 2010	1850 - 2010
Maximum operating width	mm	1100 - 1350 - 1600	1100 - 1350 - 1600	1100 - 1350 - 1600	1100 - 1350 - 1600
Min-max processing thickness	mm	3 - 160	3 - 160	3 - 160	3 - 160
Development of longitudinal sanding belts	mm	1380 x 2620	1380 x 2620	1380 x 2620	1380 x 2620
Advance speed	m/min	4 - 20	4 - 20	4 - 20	4 - 20
Operating pressure	bar	6	6	6	6
Weight	Kg	3250 - 4000 - 4900	4500 - 5500 - 6000	6700 - 8200 - 11400	8200 - 11000 - 15200
Motor power of up to	Kw (Hp)	56 (75)	56 (75)	56 (75)	56 (75)

		VIET VALERIA - 1s	VIET VALERIA - 2s	VIET VALERIA - 3s	VIET VALERIA - 4s
A' 1100 - 1350 - 1600	mm	2850 - 3100 - 3400	2850 - 3100 - 3400	2850 - 3100 - 3400	2850 - 3100 - 3400
B'*	mm	2400	3050	3600	4500
C' 2620	mm	2400 - 2560	2400 - 2560	2400 - 2560	2400 - 2560
C' 3250	mm	2720 - 2880	2720 - 2880	2720 - 2880	2720 - 2880
Maximum operating width	mm	1100 - 1350 - 1600	1100 - 1350 - 1600	1100 - 1350 - 1600	1100 - 1350 - 1600
Min-max processing thickness	mm	3 - 160	3 - 160	3 - 160	3 - 160
Development of longitudinal sanding belts	mm	1380 x 2620 - 3250	1380 x 2620 - 3250	1380 x 2620 - 3250	1380 x 2620 - 3250
Advance speed	m/min	4 - 20	4 - 20	4 - 20	4 - 20
Operating pressure	bar	6	6	6	6
Weight	Kg	2950 - 3600 - 4400	4100 - 5000 - 6000	6100 - 7500 - 11000	8200 - 10000 - 14500
Motor power of up to	Kw (Hp)	56 (75)	56 (75)	56 (75)	56 (75)

\* When creating a line composed of the lower and upper Valeria machines, in order to estimate the total length of the line, the length of the upper model must be added to that of the lower model.

The technical specifications and drawings are non-binding. Some photos may show machines equipped with optional features. Biesse Spa reserves the right to carry out modifications without prior notice.

Weighted sound pressure levels at the machine entry operator station: 75.0 dB(A) without load, 76.0 dB(A) with load. Weighted sound pressure levels at the machine exit operator station: 70.5 dB(A) without load, 71.0 dB(A) with load.

VIET Srl. designed the machine to reduce airborne noise emission at source to the lowest possible level, in accordance with the requirements of Community Directive 2006/42/EC, and commissioned a test to determine the sound pressure emission level at the operator station for the smoothing/sanding machine.  
Standards: The measurement was carried out in compliance with UNI EN ISO 19085-8:2018, UNI EN ISO 11202:2010. The noise levels shown are emission levels and do not necessarily correspond to safe operation levels. Even though there is a relation between emission levels and exposure levels, this cannot be used reliably to establish whether further precautions are necessary. The factors determining the noise levels to which the operative personnel are exposed include the length of exposure, the characteristics of the work area, as well as other sources of dust and noise, etc. (i.e. the number of machines and processes concurrently operating in the vicinity). In any case, the information supplied will help the user of the machine to better assess the danger and risks involved.

# MADE WITH BIESSE

## SANDING AND PROFILING WITH A SINGLE SOLUTION

Alpilegno, a Leader in the sector of high-quality, high-performance windows and doors, performs sanding operations followed by profiling operations in its Val di Ledro (TN) manufacturing unit. Loris Cellana, an entrepreneur with long-standing experience in this sector, recalls how he evaluated machinery and system suppliers for over two years to find one that could guarantee a cutting-edge finished product: "In the end I chose Biesse". The core of the new manufacturing line is a Uniwin machine, combined with a modern 5-axis Rover C that produces doors. "I think that Uniwin is already a good profiling machine in itself, but what was equally important to me was its interaction with other line components, such as the planer, the sanding machine and the press, and the material flow between the various machines". Components are custom-cut and stored

in a loading device by Biesse's automation programme that feeds the automatic planer. A conveyor belt moves the work pieces from the planer directly to the sanding machine (a Viet Narrow 334 Bottom, also supplied by Biesse). From there, the components are sent to the Uniwin's loader, from which they are picked to be fully processed. 72, 80, 92 and 104 mm thicknesses in wood and wood-aluminium are processed. The magazines house up to 98 tools that are always available. Such tools can be changed in real time during machine operation thanks to a chain-operated tool-changer. "Assembly precision enables us to avoid having to remove glue residues from the frame", explains Cellana: "in this way, surface calibration and sanding must be arranged the one after the other, to go to the pressing stage immediately after profiling". Moreover, individual components

are not painted before they are pressed, as it is customary. As a matter of fact, Cellana paints the entire frame. The compact production line occupies a footprint of only 15x15 metres; components are always handled forward and backward from the planing to the profiling machine, leaving enough space also for a walkway. "I like Biesse's solution: it is compact, the machines are efficient and, since they all come from the same supplier, it is easy to learn how to operate them", explains a visibly satisfied Cellana.

*Source: Holzkurier Austrian magazine/special Nuremberg Exhibition issue.*



# SERV ICE & PARTS

Direct, seamless co-ordination of service requests between Service and Parts. Support for Key Customers by dedicated Biesse personnel, either in-house and/or at the customer's site.

## BIESSE SERVICE

- ✔ Machine and system installation and commissioning.
- ✔ Training centre dedicated to Biesse Field engineers, subsidiary and dealer personnel; client training directly at client's site.
- ✔ Overhaul, upgrade, repair and maintenance.
- ✔ Remote troubleshooting and diagnostics.
- ✔ Software upgrade.

**500**

Biesse Field engineers in Italy and worldwide.

**50**

Biesse engineers manning a Teleservice Centre.

**550**

certified Dealer engineers.

**120**

training courses in a variety of languages every year.

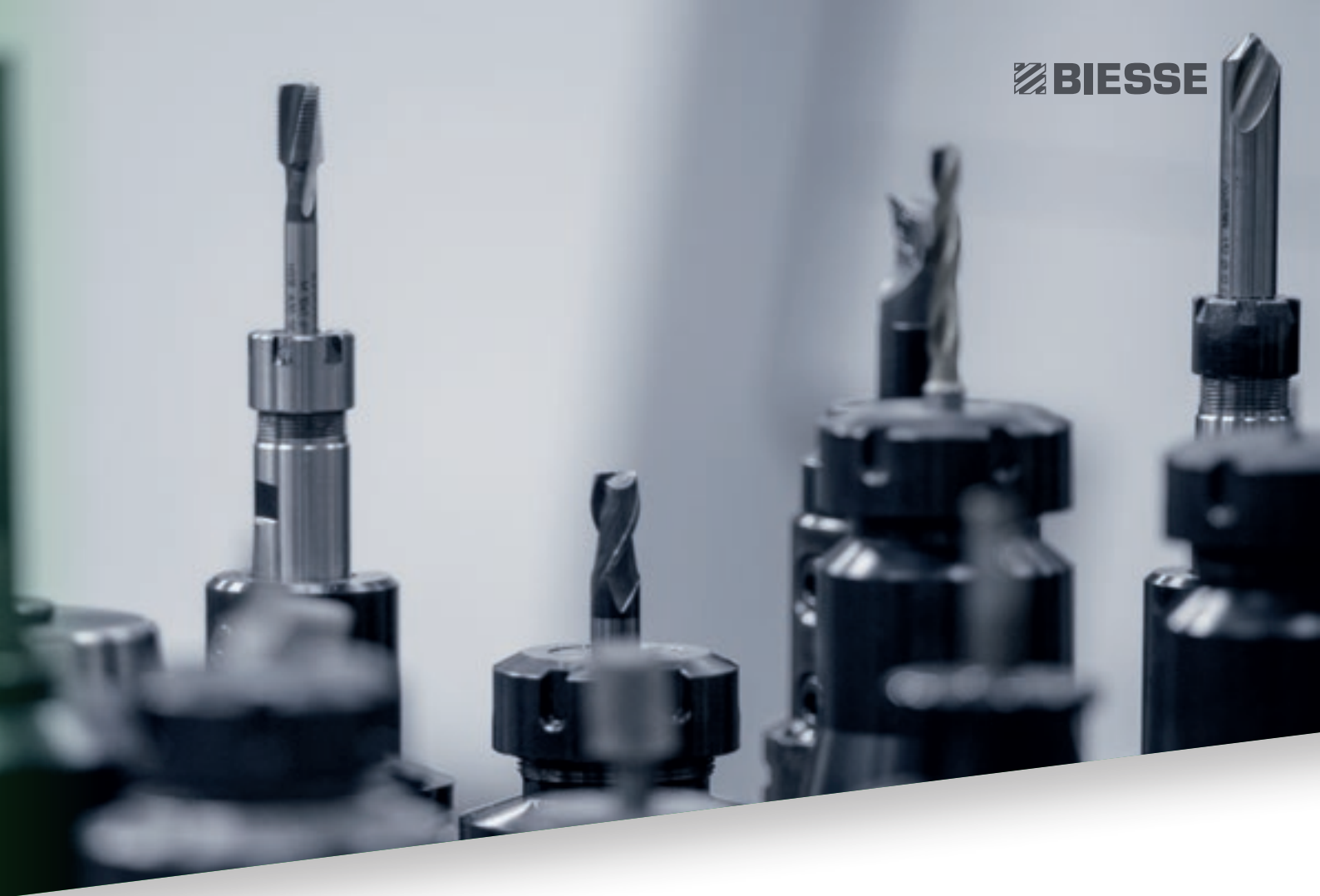

A close-up photograph of several metal drill bits and tool components, arranged in a row. The bits are of different sizes and designs, some with standard double-flute and others with more complex, multi-fluted designs. They are set against a blurred background, highlighting their metallic texture and sharp edges.

The Biesse Group promotes, nurtures and develops close and constructive relationships with customers in order to better understand their needs and improve its products and after-sales service through two dedicated areas: Biesse Service and Biesse Parts. With its global network and highly specialized team, it offers technical service and machine/component spares anywhere in the world on-site and 24/7 on-line.

## BIESSE PARTS

- ✔ Original Biesse spares and spare kits customized for different machine models.
- ✔ Spare part identification support.
- ✔ Offices of DHL, UPS and GLS logistics partners located within the Biesse spare part warehouse, with multiple daily pick-ups.
- ✔ Order fulfillment time optimized thanks to a global distribution network with de-localized, automated warehouses.

**92%**  
of downtime machine orders fulfilled  
within 24 hours.

**96%**  
of orders delivered in full on time.

**100**  
spare part staff in Italy and worldwide.

**500**  
orders processed every day.

# LIVE THE EXPERIENC

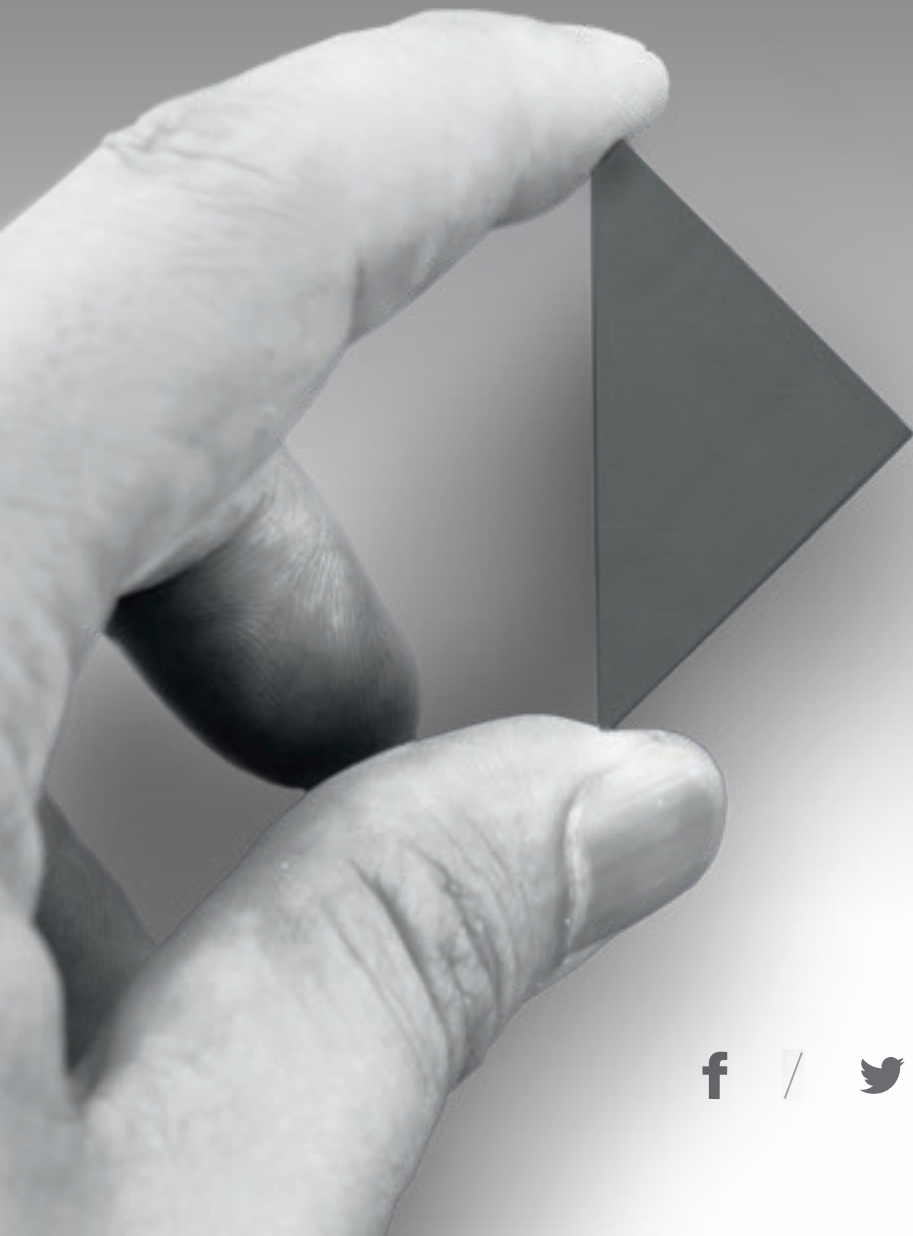

BIESSEGROUP.COM

E



Interconnected technologies and advanced services that maximise efficiency and productivity, generating new skills to serve better our customer.

**LIVE THE BIESSE GROUP EXPERIENCE AT OUR CAMPUSES ACROSS THE WORLD.**

 **BIESSEGROUP**

