

# Jade 300 series



Rev. 02/10

**BIESSE**

The information, texts, images, data, graphics and anything else that can be classed as "contents" is confidential, and destined solely for the use of suitably authorized staff from the Biesse group.

The above "contents" are protected by copyright (D.Law N° 68 / 2003), as they are originals and intellectual property.

The document must not be divulged, distributed and/or copied in any way, even in part, as this is prohibited both under art. 616 of the p.c. and under Decree Law N° 196/2003 on privacy. Any form of abuse will result in legal prosecution.



Jade 320 - 325



**BULLET POINTS**

Jade 335 - 340



**BULLET POINTS**

**QUIT**



# Jade 325

WOOD DIVISION



# Jade 320-325: general technical data

WOOD DIVISION

Height panel workable	10-60 mm
Thickness of edge-banding material	0,4-10 (12*) mm
Max. height of edge-banding material	65 mm
Working speed	12 m/min
Min. panel length	140 mm
Min. panel width (with min. length 250 mm)	50 mm
Min. panel width (with min. length 140 mm)	85 mm
Panel protrusion from track (working line)	25 mm

\* For strips of solid wood length > 480 mm

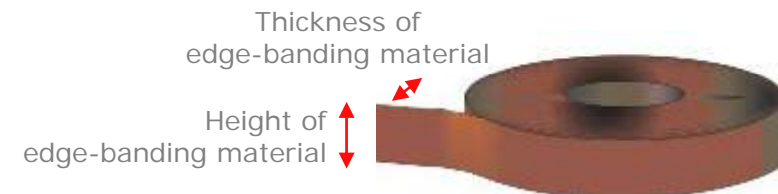
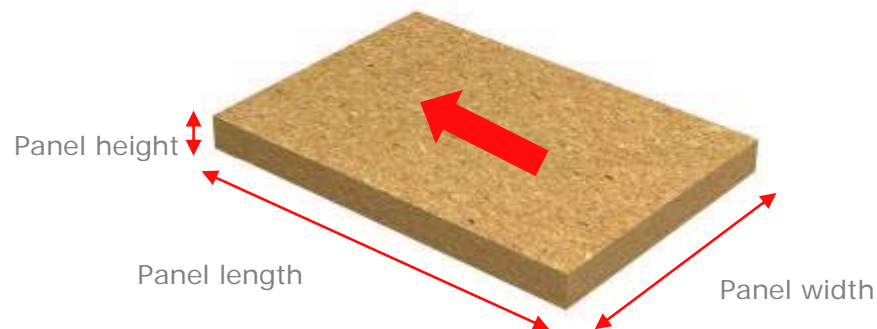

# Jade 340

WOOD DIVISION



**BIESSE**ARTECH

[Home](#)

[Compositions](#)

[Basic MC](#)

[NC](#)

[Units](#)

[Layout](#)

# Jade 335-340: general technical data

WOOD DIVISION

Height panel workable	10-60 mm
Thickness of edge-banding material	0,4-10 (12*) mm
Max. height of edge-banding material	65 mm
Working speed	12 m/min (12-18 opt)
Min. panel length	140 mm
Min. panel width (with min. length 250 mm)	50 mm
Min. panel width (with min. length 140 mm)	85 mm
Panel protrusion from track (working line)	25 mm

\* For strips of solid wood length > 480 mm

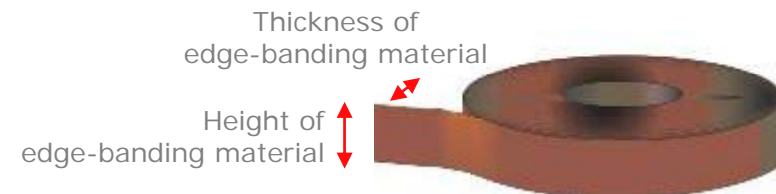
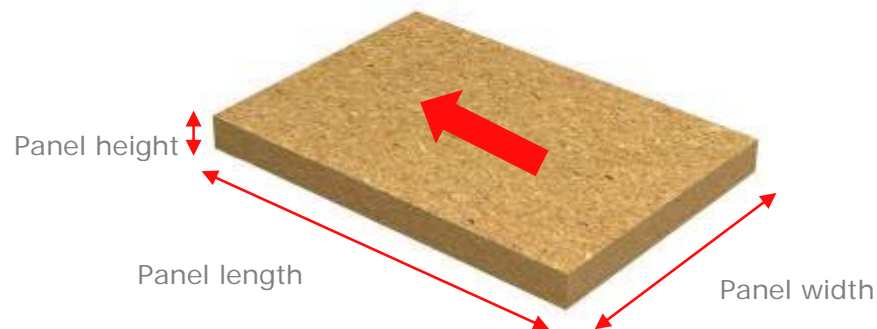

# Available composition

WOOD DIVISION

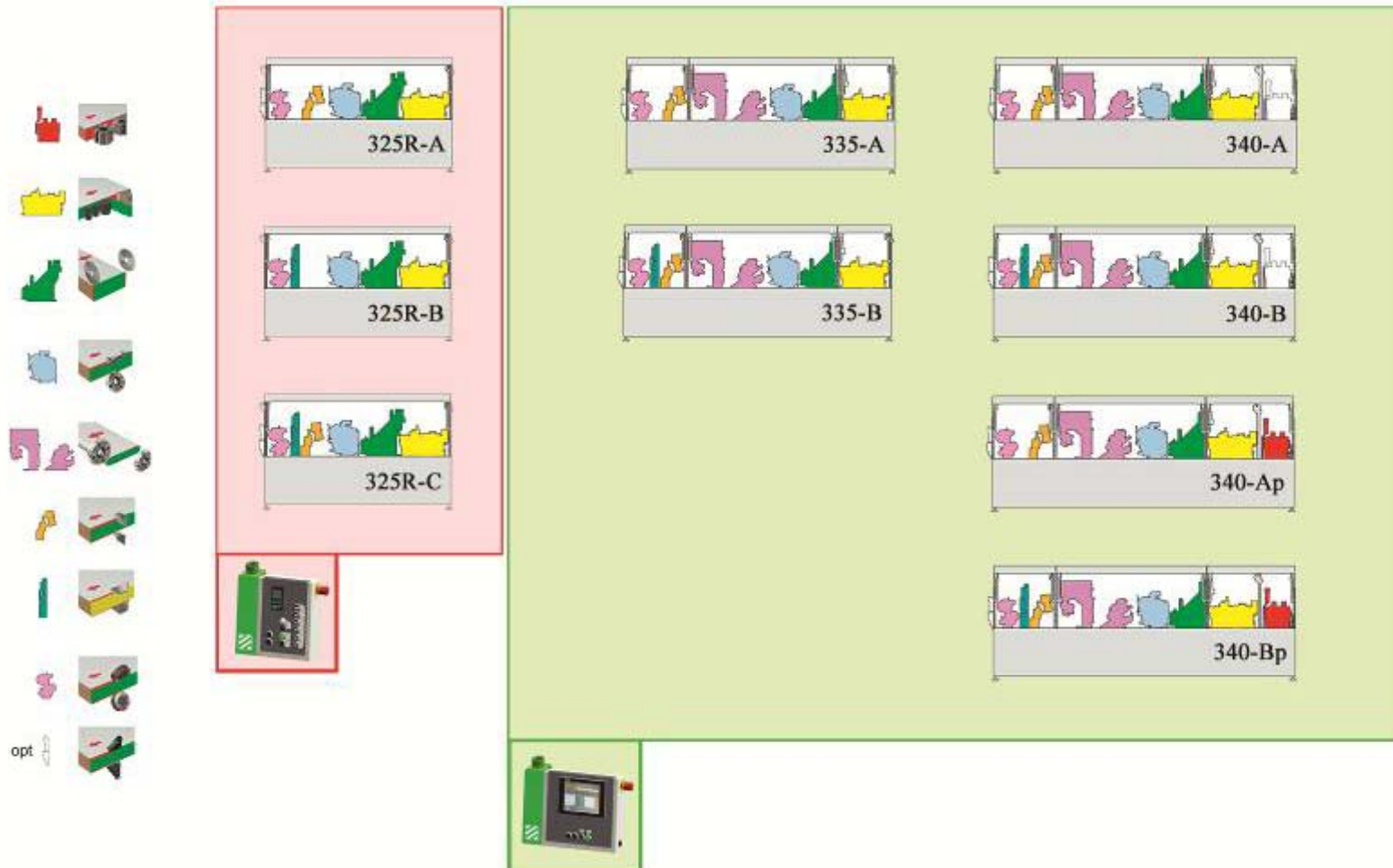



# Structure of the machine



## ■ General features

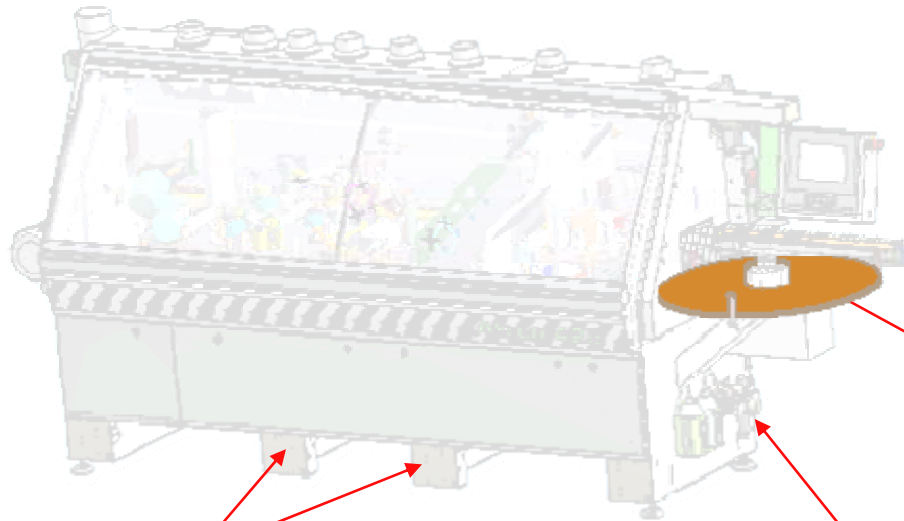

Holes for lifting with the forklift

Electrical and Pneumatic connections

Wide roll-holder (diam. 800 mm) with brushes for cleaning the edge-banding material

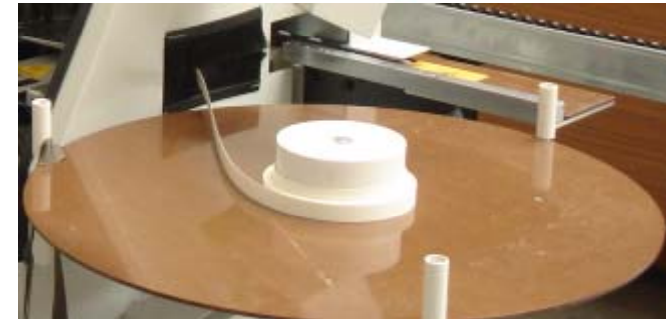

# General machine



- Designed to optimize the number of machine that can be loaded in a container. E.g. 4 Jade 320 in a container of 20 foot.

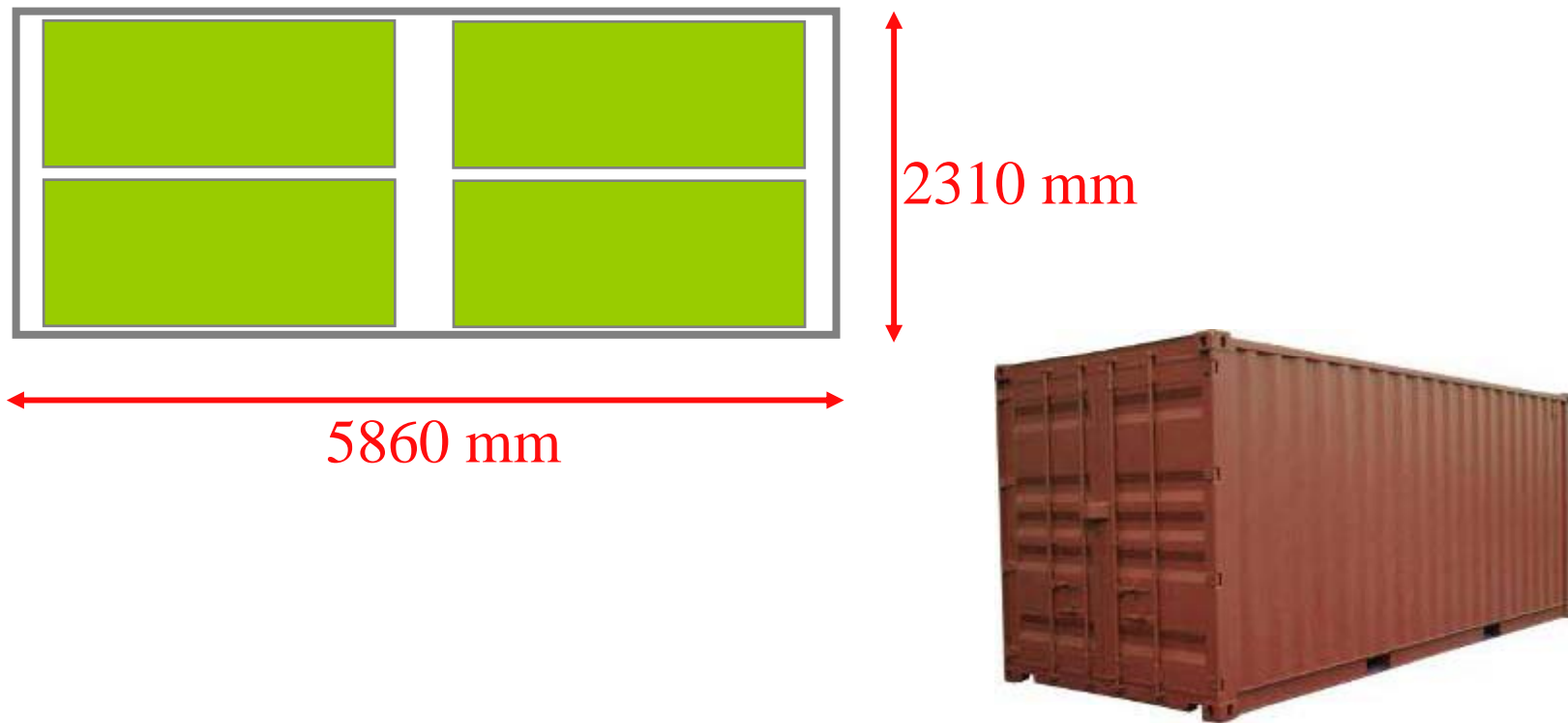

# General machine - packaging

WOOD DIVISION



Std. packaging



Pallet + VCI



Crate packing

# Structure of the machine

WOOD DIVISION

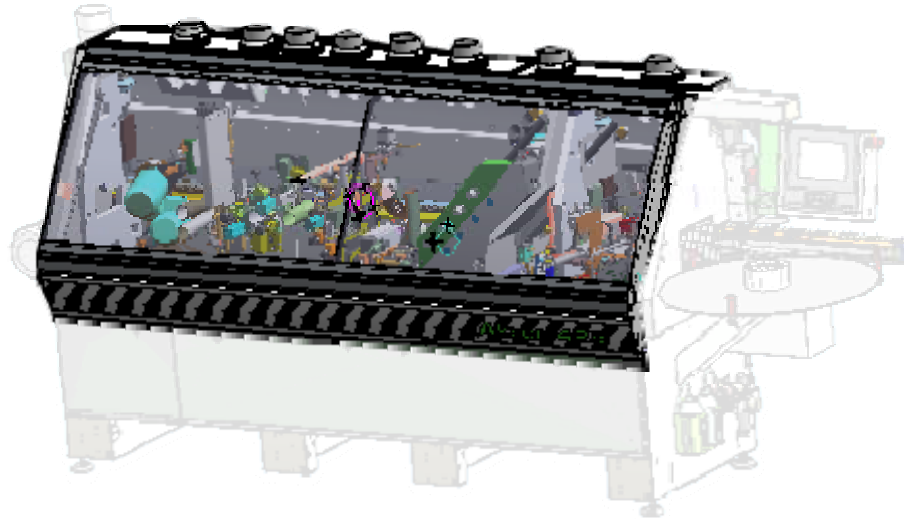

- Protective cabin and dust extraction system

# Structure of the machine



Protection cabins made of extruded aluminium

## CHARACTERISTICS

- Light and strong
- Wide and clear view of the operating units also with the cabins closed
- Each cabin has a safety micro switch
- Reduced floor space requirement

## CUSTOMER ADVANTAGES

- Safety for workers
- Minimum space required for the machine

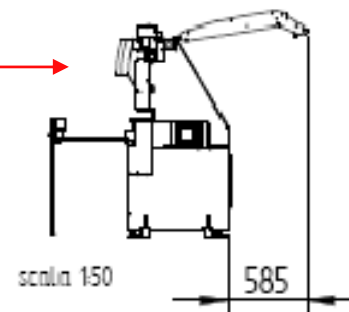

# Dust extraction system



## CHARACTERISTICS

- The dust extraction has an individual outlet for each unit (like in double sided squaring-edgebanding machines)
- Lengths of pipes are optimized

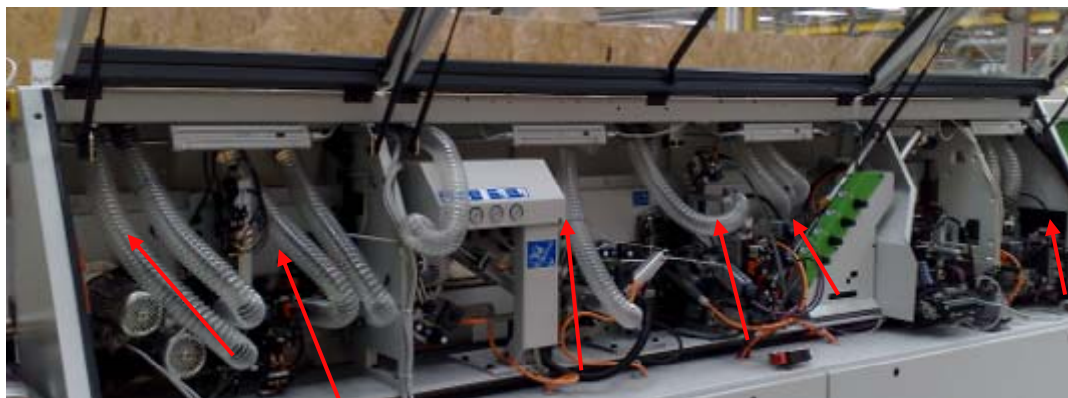

## CUSTOMER ADVANTAGES

- Increased dust extraction efficiency
- Tidier machine

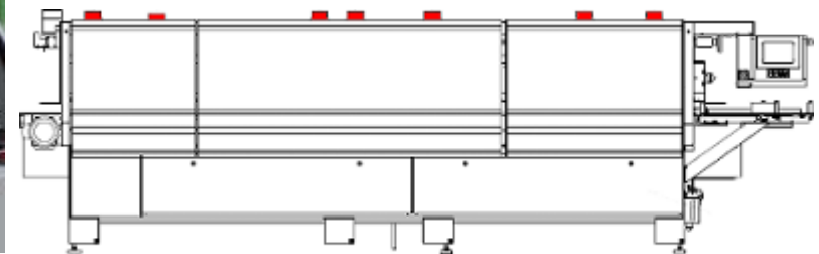

# Dust extraction system



## CHARACTERISTICS

- Each unit (included dynamic groups like the end trimming and the corner rounding unit) **includes** suction hoods **integral** with motors.

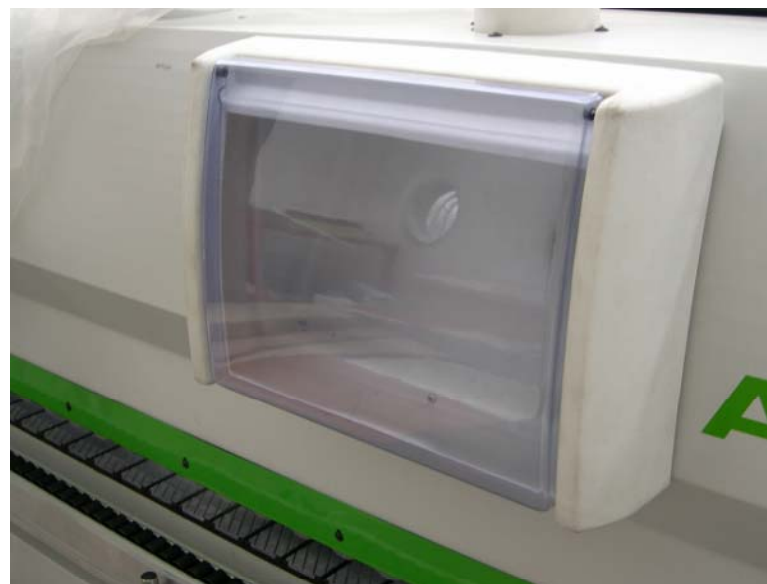

# Structure of the machine

WOOD DIVISION

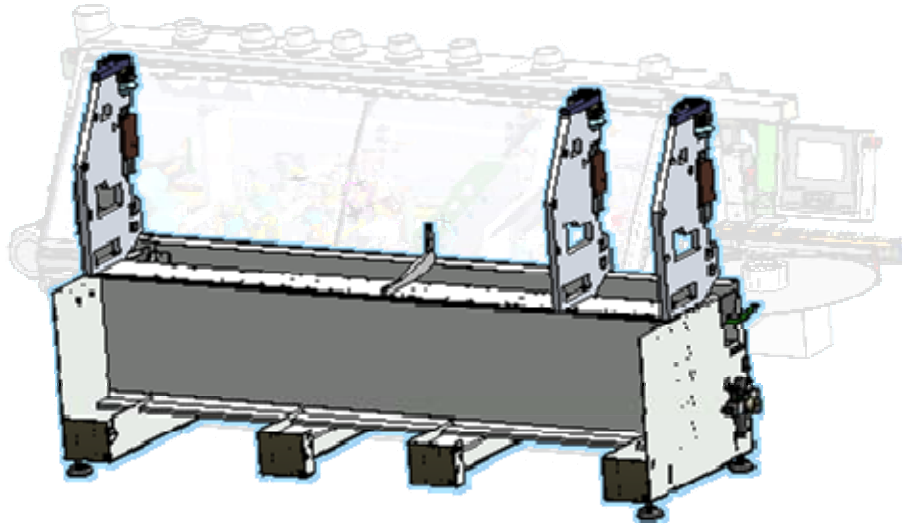

## CHARACTERISTICS

- Monolithic frame
- Strong columns

## CUSTOMER ADVANTAGES

- Machine Steadiness and solidity
- HIGH quality workmanship





# Frame



## CHARACTERISTICS

- Made with an opening that allows the automatic dumping of chips and cut offs.

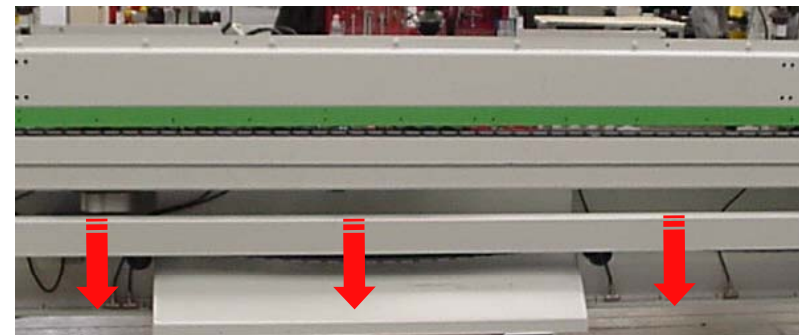
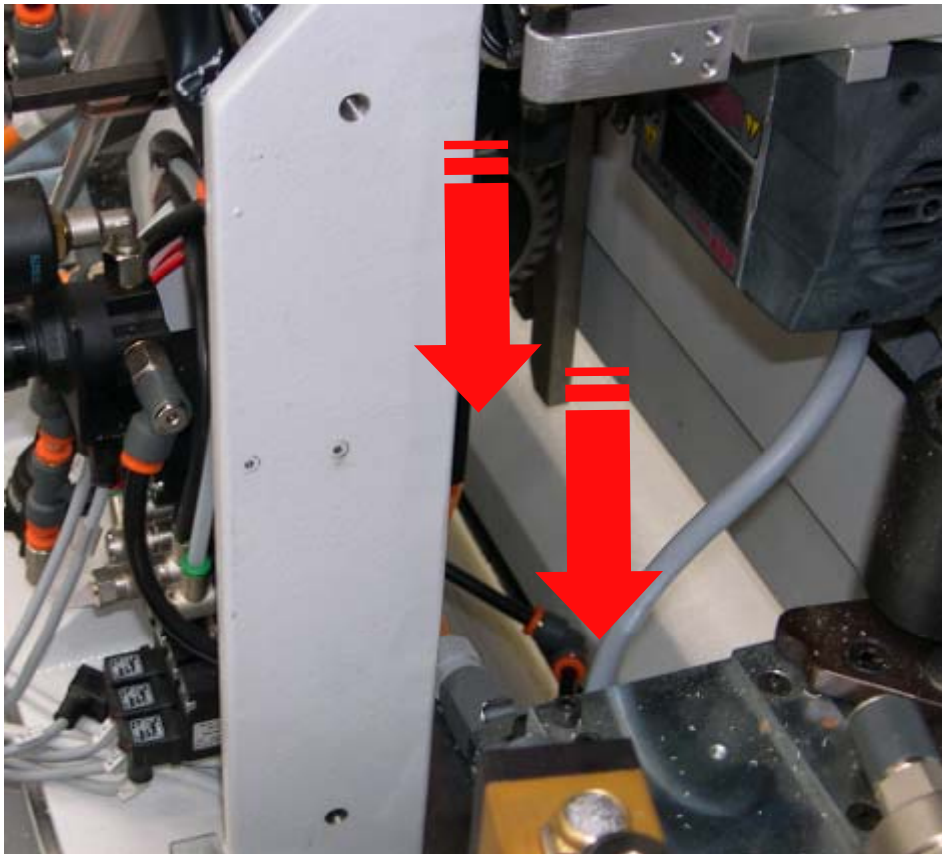

## CUSTOMER ADVANTAGES

- Better cleanliness of the machine

# Structure of the machine

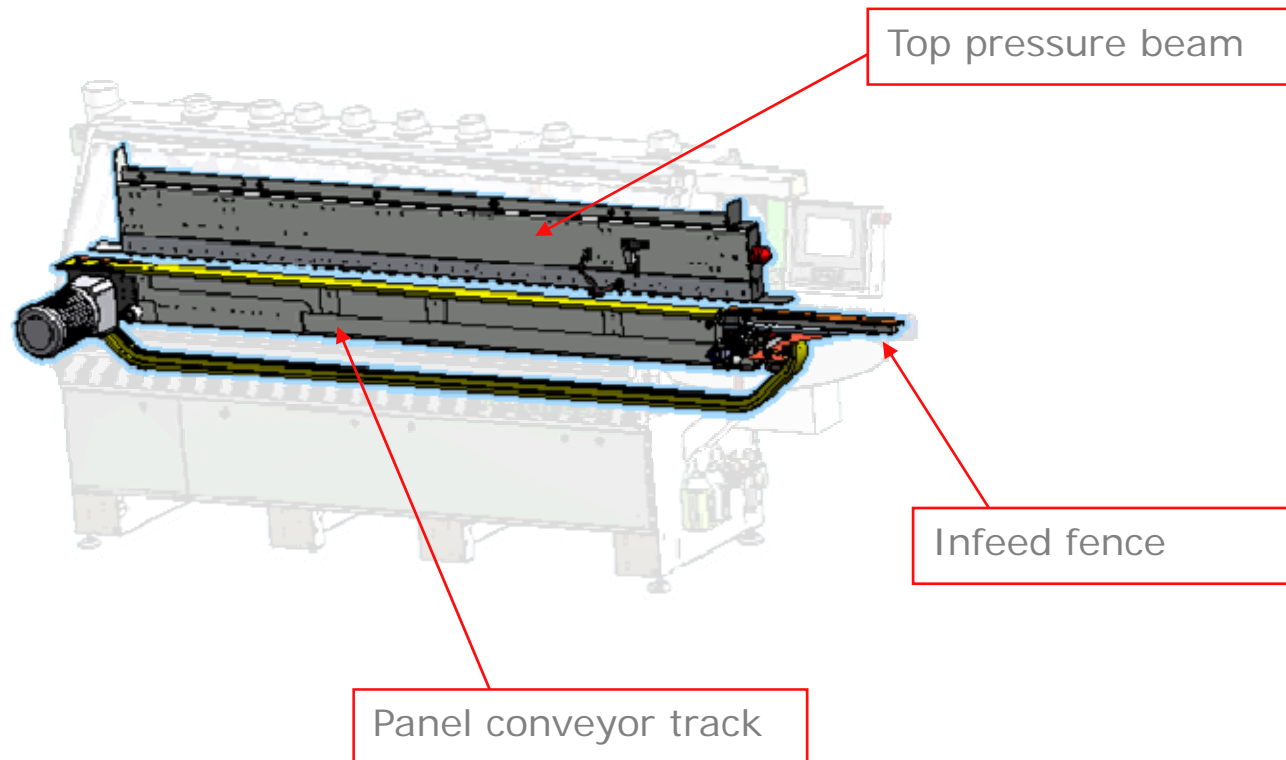

# Panel conveyor

WOOD DIVISION



## CHARACTERISTICS

- Chain size 1" -1/4: the biggest in its segment
- Chain is completely protected from chips and dust for the entire length of the machine

## CUSTOMER ADVANTAGES

- Precise panel transportation

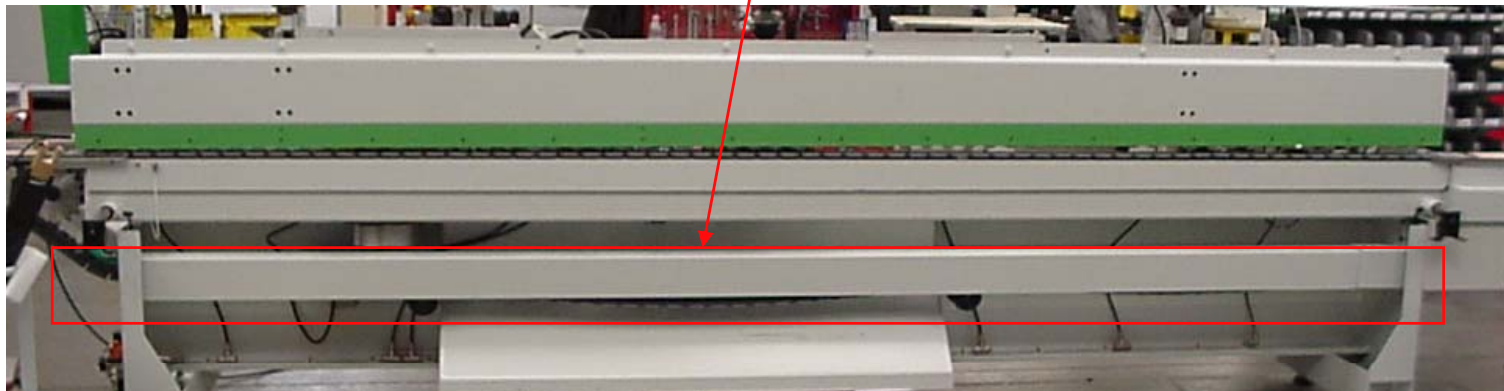

# Work-piece transportation system



## CHARACTERISTICS

- Large and high-grip pads
- High resistance to side loads
- All pads are interchangeable

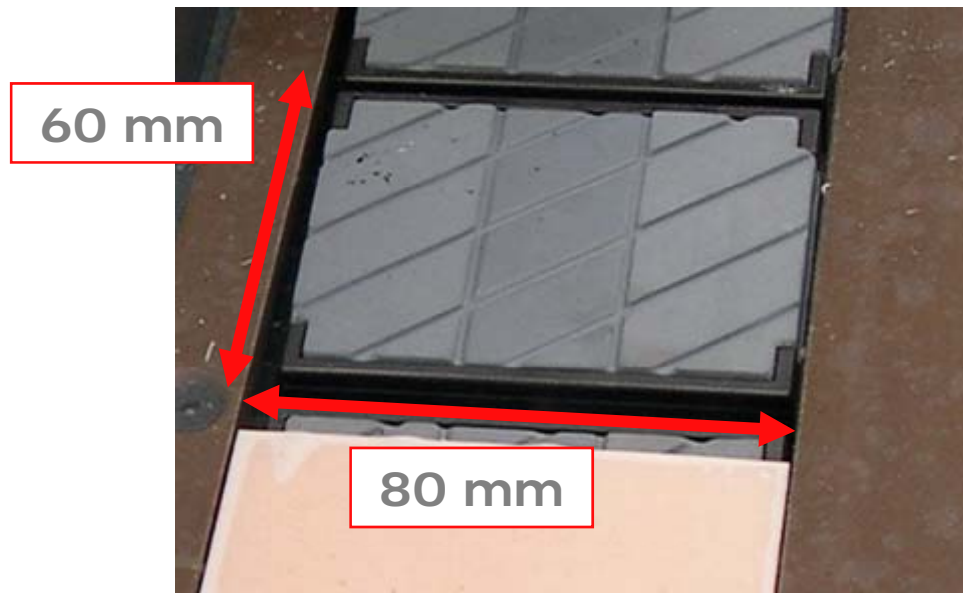

## CUSTOMER ADVANTAGES

- Steady and secure transportation
- Panel high quality

# Work-piece transportation system



## CHARACTERISTICS

- The chain guidance that uses the round+flat guides, it is the best panel transport system.
- The movement is linear and highly resistant to the side loads.
- Possible "clearance" caused by wear and tear do not modify the geometry of the system.
- The flat guide works as support and carries out its function correctly even if the two guides are not perfectly parallel to each other.

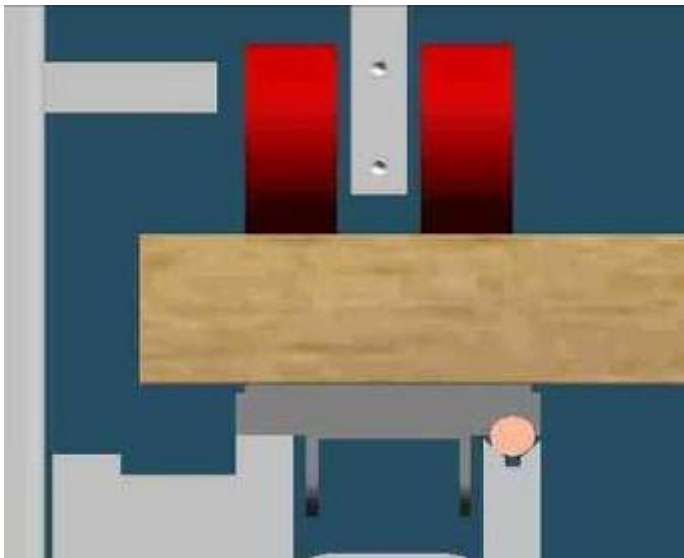

Lubrication of the 2 guides with a pump (supplied with the machine)

# Competitors transportation system

WOOD DIVISION

The linearity of the movement of the chain pads, is obtained thanks to the guidance provided by the lateral surfaces of the pad highlighted in red.

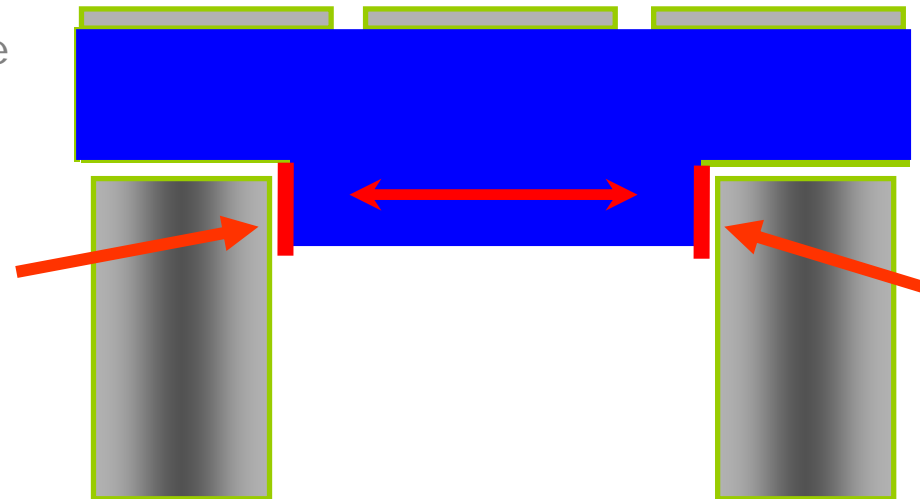

Over the time, such guidance system loses its precision because of the lateral clearance eventually originated by the wear and tear of the reference surfaces. The lack of parallelism between the two guides worsen the problem.

# Competitors transportation system

WOOD DIVISION

The linearity of the movement of the chain pads, is obtained thanks to the guidance provided by the lateral surfaces of the pad highlighted in red.

(The other guide works only as support).

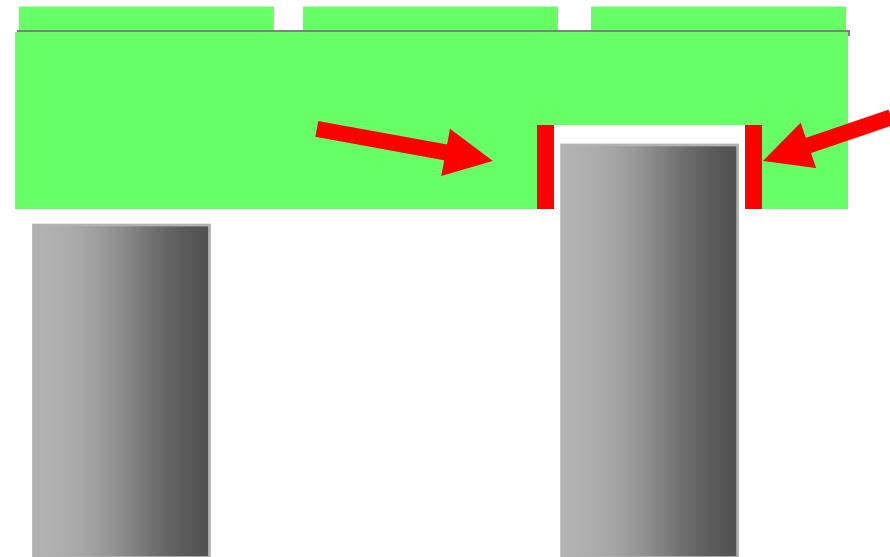

Over the time, such guidance system loses its precision because of the lateral clearance eventually originated by the wear and tear of the reference surfaces.

# Top pressure beam



## CHARACTERISTICS

- Steel top pressure beam
- Double line of rubber pressing wheels

## CUSTOMER ADVANTAGES

- Excellent stability of the piece
- Linearity of the movement
- Resistance to side loads



# Top pressure beam lifting



- On Jade the lifting of the beam is manual through an handle and digital indicator

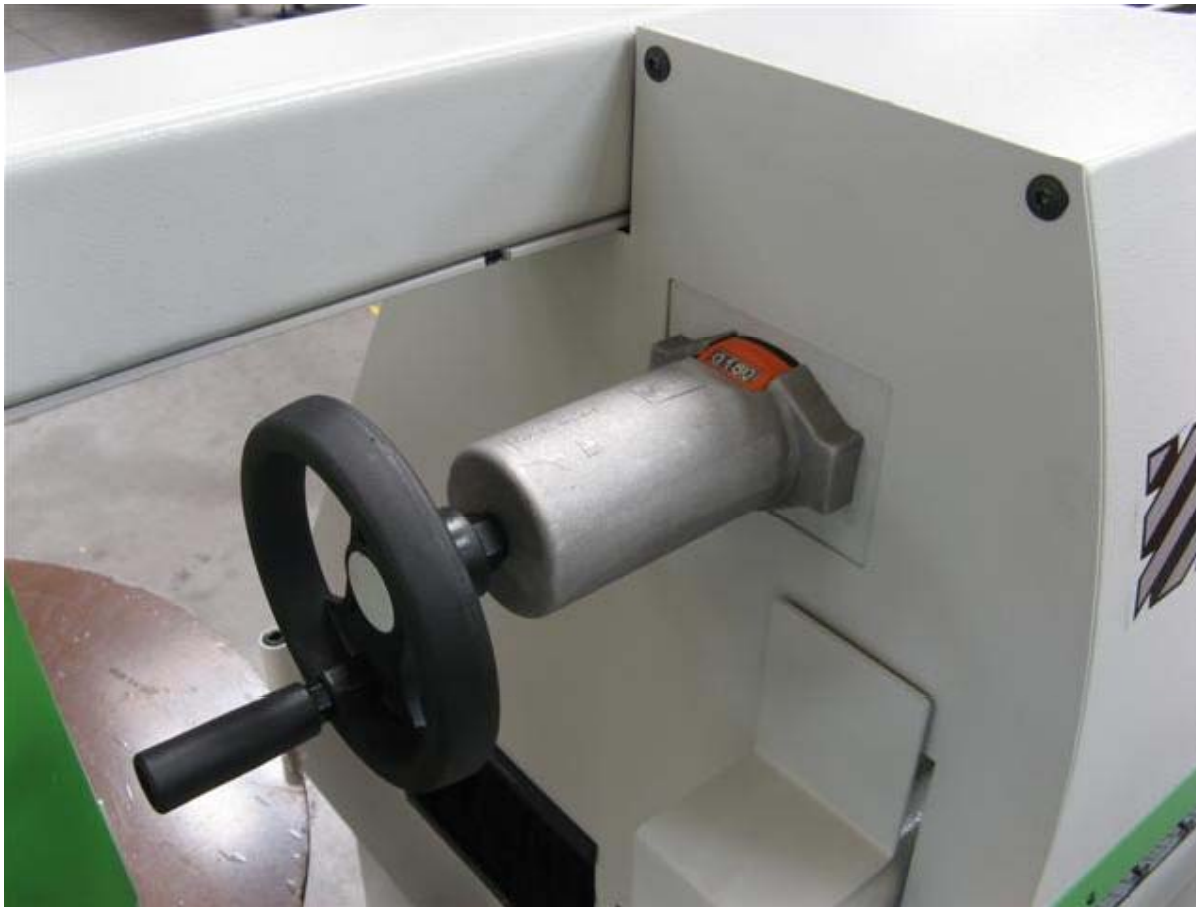

# Top pressure beam lifting



## CHARACTERISTICS

- Vertical movement on hardened round guides with ball bush



## CUSTOMER ADVANTAGES

- Precision
- Reliability



# Top pressure beam

WOOD DIVISION



ADVANTAGES:

## CUSTOMER ADVANTAGES

- No clearance
- Precision over the time

## CHARACTERISTICS

- The rubber presser wheels are mounted on two staggered rows to ensure an optimal work-piece holding
- Each wheel is mounted on a ball bearing
- Distance between centres 32 mm

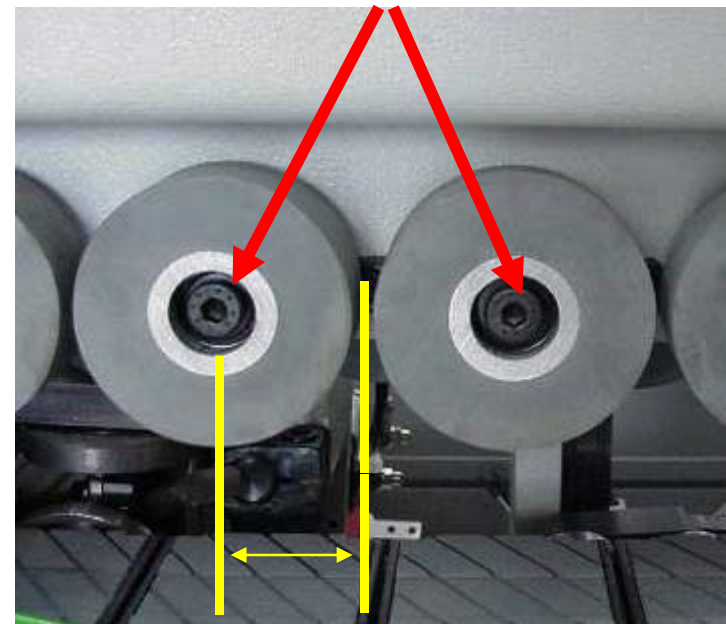

32 mm

**BIESSEARTECH**

Home

Compositions

Basic MC

NC

Units

Layout

# Top pressure beam



- The geometry of the top pressure wheels

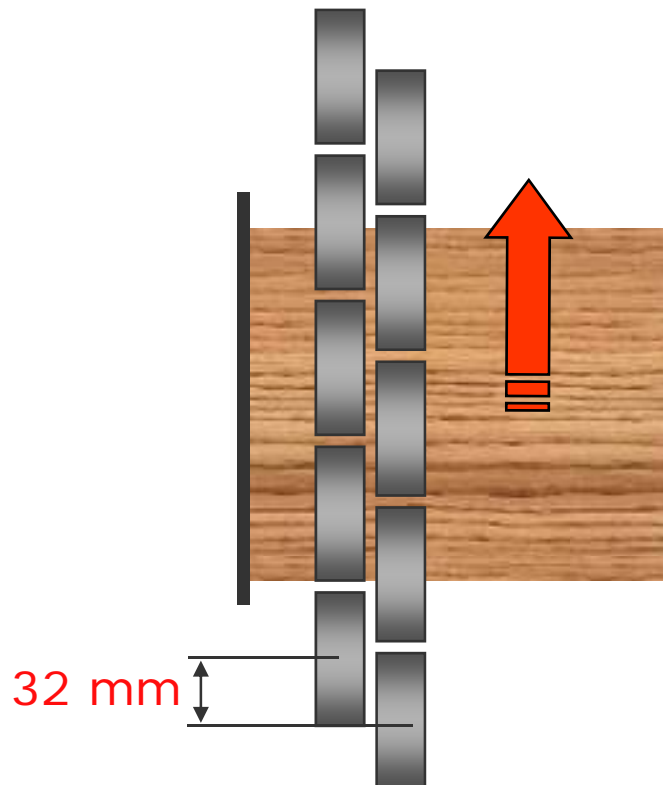

## Competitors

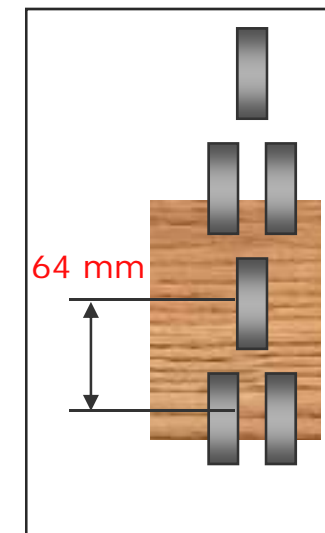
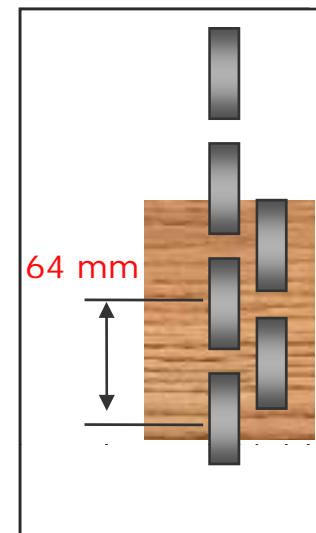
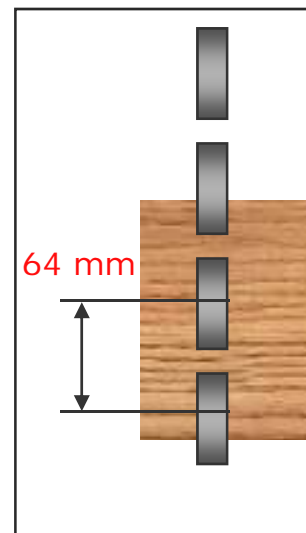

# Top pressure beam



SOME COMPETITORS

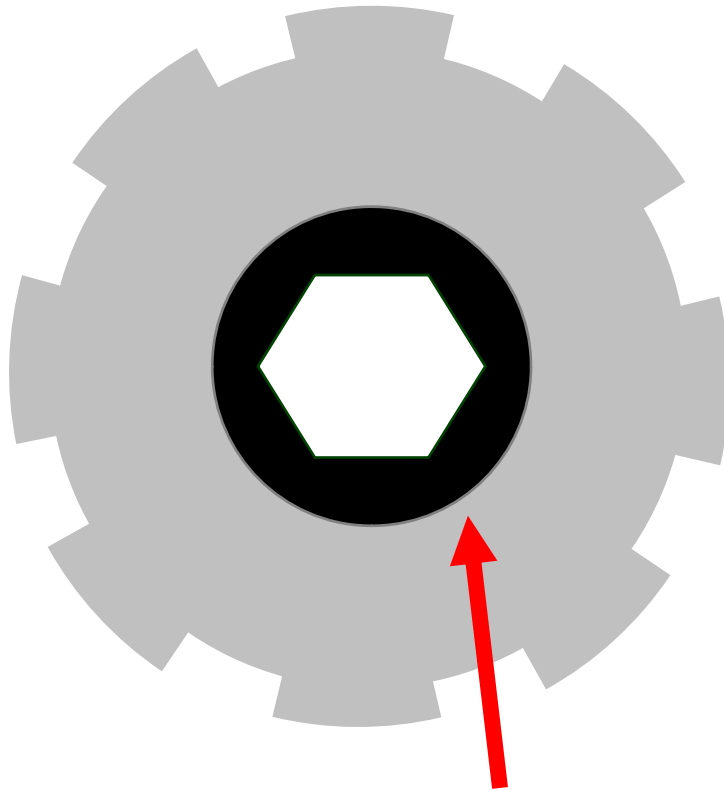

Mounted on bushing

Jade

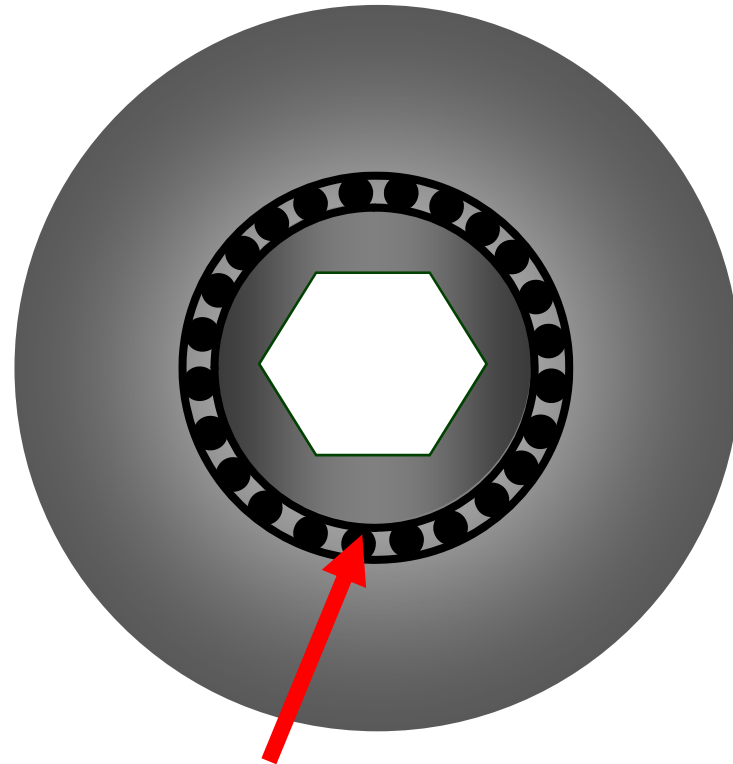

Mounted on ball bearing

# Top pressure beam

WOOD DIVISION

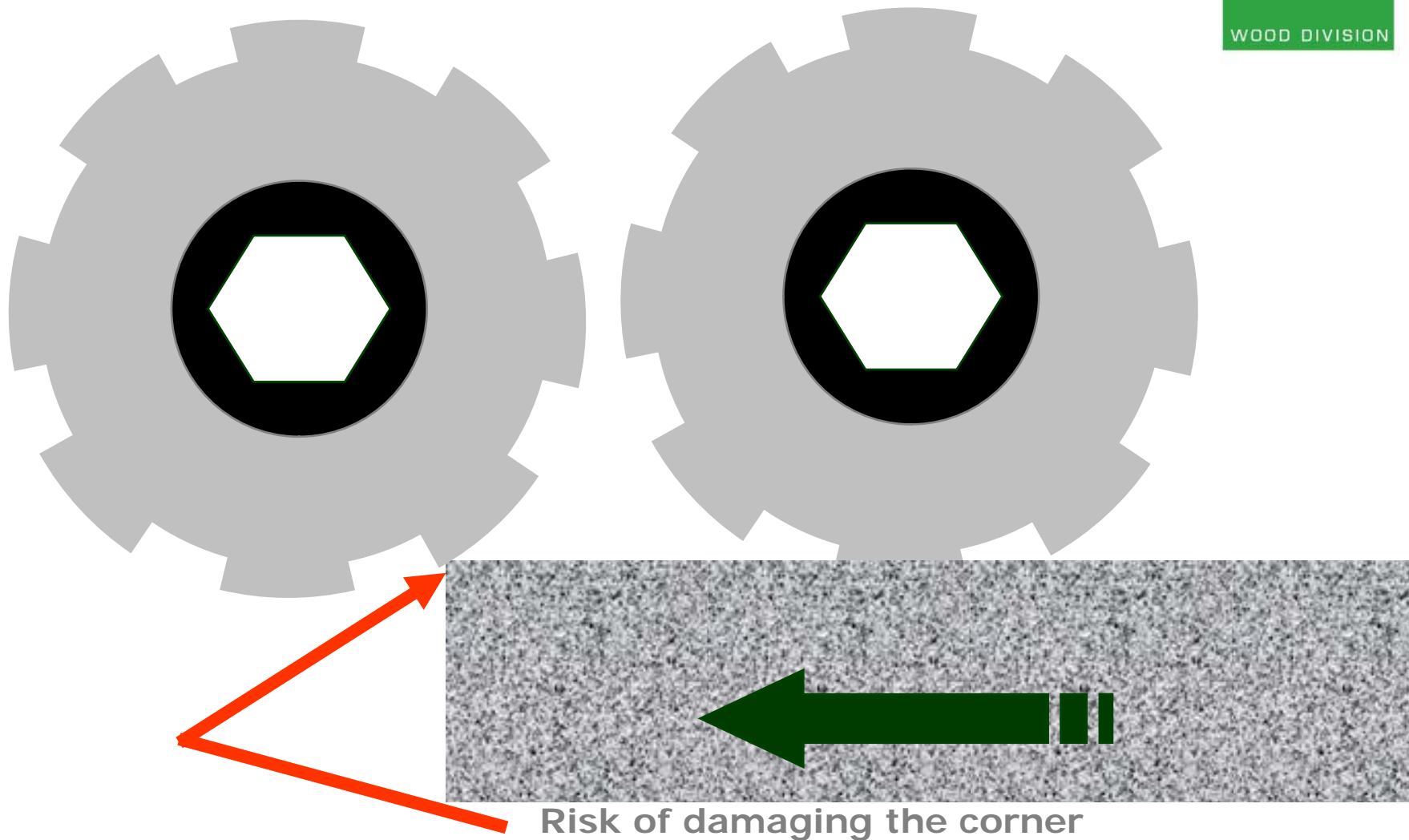

# Top pressure beam



## CHARACTERISTICS

- All the rubber rollers of the top pressure beam, are internally and externally protected for the entire length of the machine, from possible shavings, glue and other residuals.

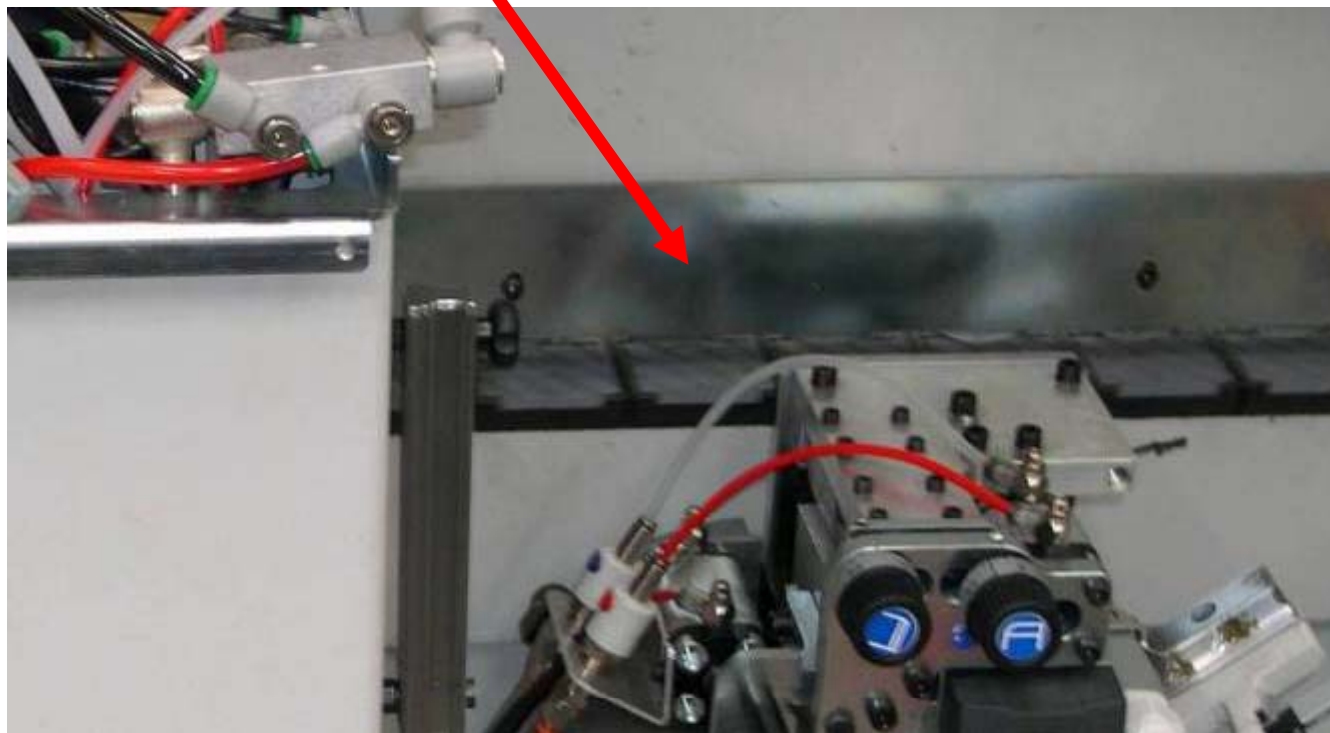

# Infeed fence



## CHARACTERISTICS

- In machines with premilling unit, the infeed fence is manually adjustable
- Long infeed fence to ease the feeding of large panels

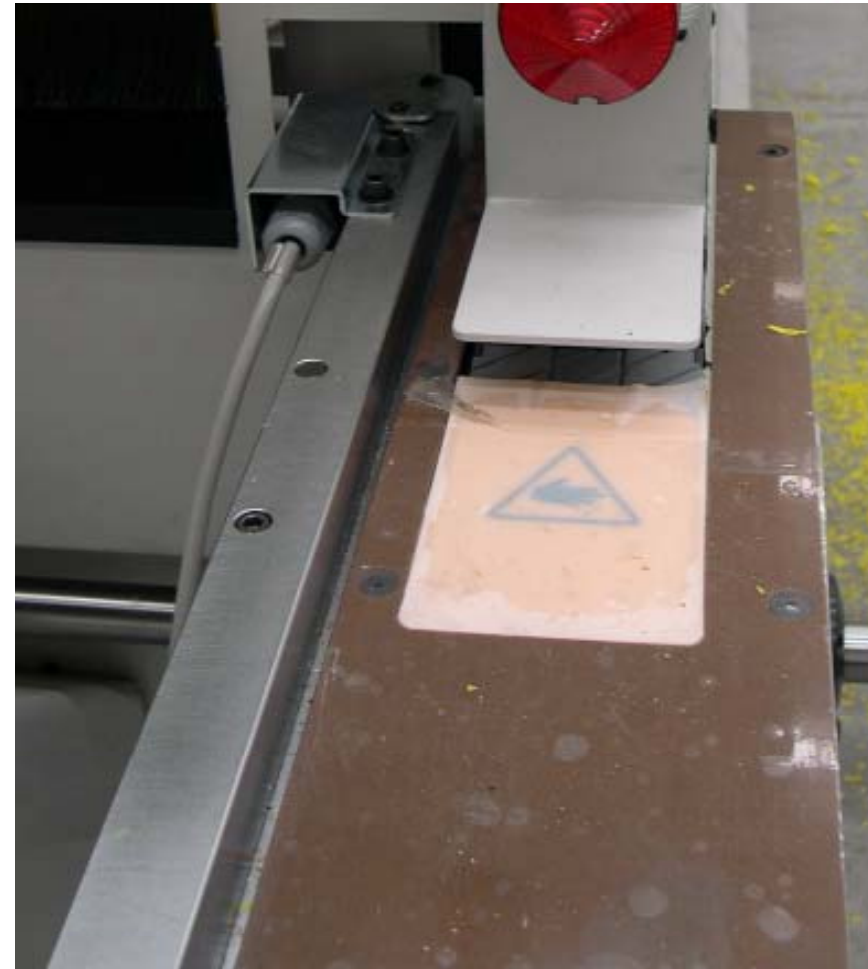
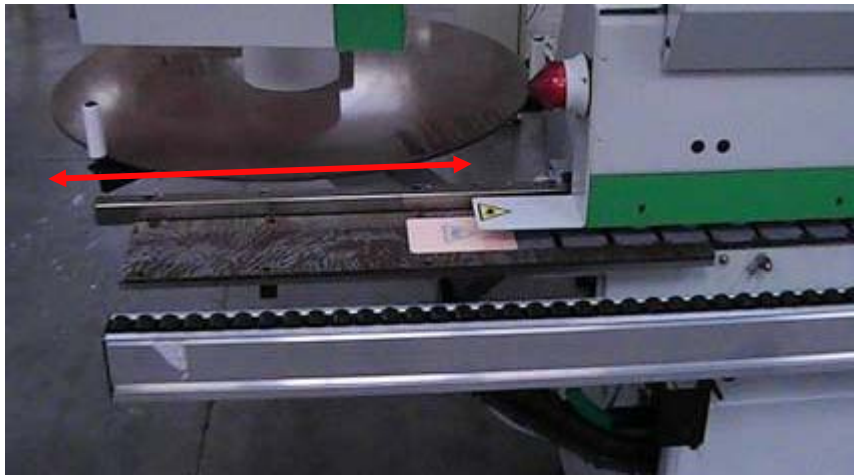



# Structure of machine



## Electrical cabinet



### CHARACTERISTICS

- Wiring and components are labeled for an easy identification
- Valve-packs have electronics on board

### CUSTOMER ADVANTAGES

- Facilitate service and maintenance
- The machine is tidier and neater



# Structure of the machine

WOOD DIVISION

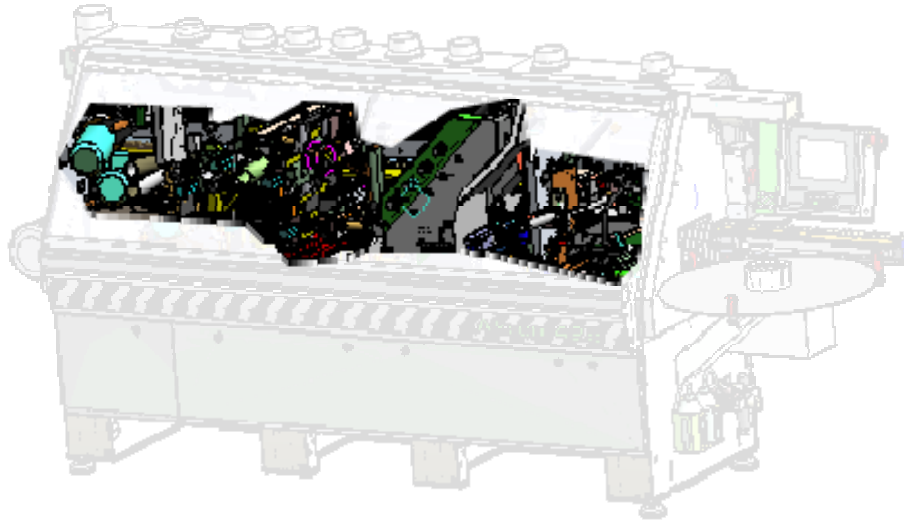

## CHARACTERISTICS

- **The main working units** (gluing unit, end trimming unit, fine milling unit , etc.) are fixed (hooked) directly on base and not “hanging” out from the top presser beam.

# Working units

WOOD DIVISION

- Jade get on standard on all range only elctrospindles of the exclusive series ROTAX.
- This very high quality electro-spindle allows power increase, compact size and very high finish.
- ROTAX are made only for Biesse from HSD world leader in the production of electro-spindle.

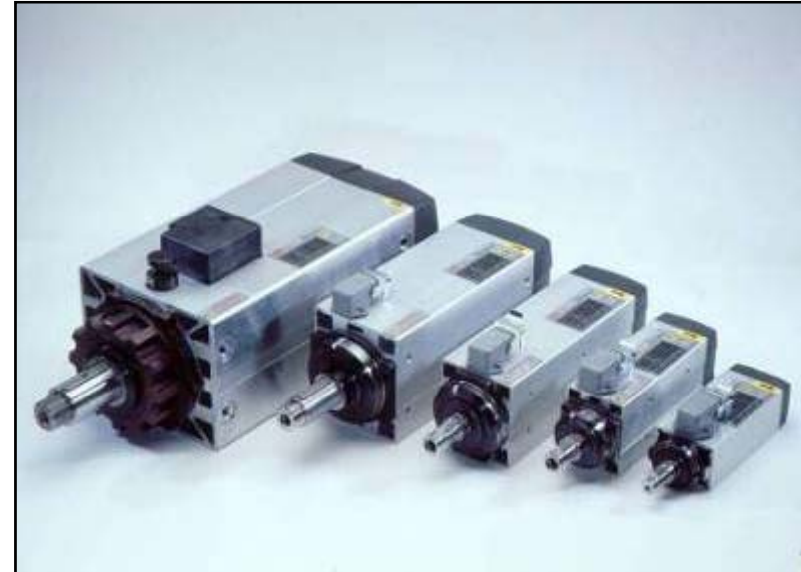

# NC



**BIESSE**

# Control board

WOOD DIVISION

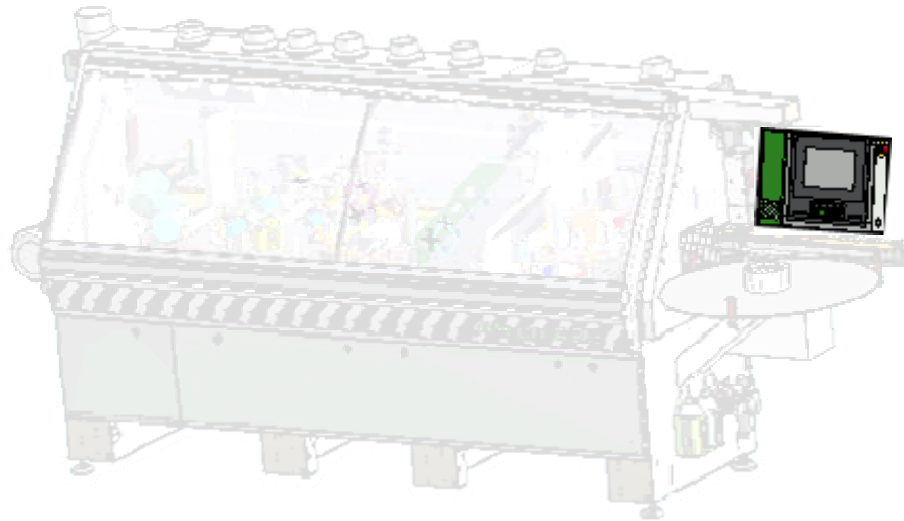

## CHARACTERISTICS

- Control board with manual selectors on Jade 320/325
- TS06 on Jade 335/340

# Jade 320/325 – control board



- Control board with manual selectors

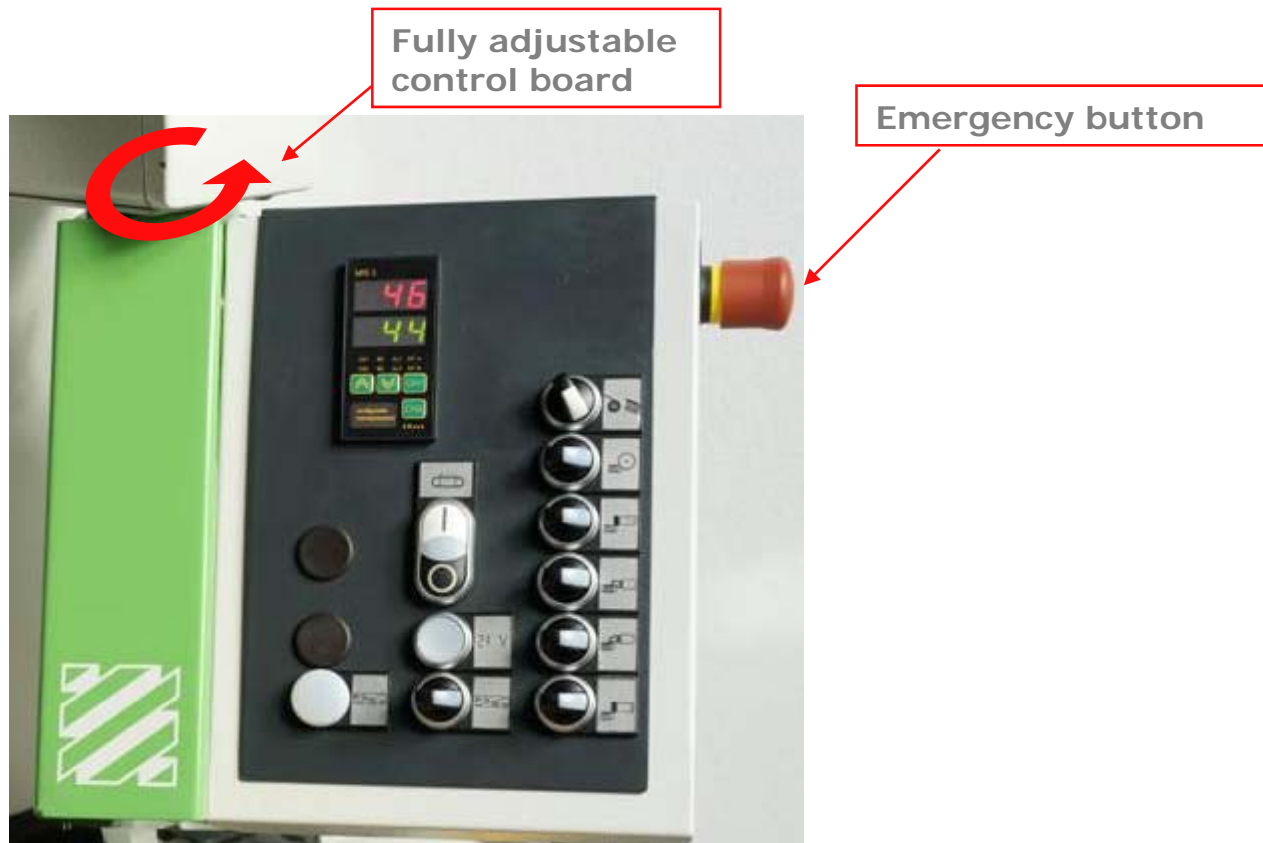

# Jade 335/340 – control board



- TS06: 6" touch screen



# Sintra LT and PLC700

WOOD DIVISION

## CHARACTERISTICS

- Simple and intuitive
- 1<sup>st</sup> and 2<sup>nd</sup> passage button
- Safety function: on request programmes locked under password
- Available in different languages
- Automatic program lists
- Interaction with Biesse Link
- Includes an integrated network card
- Windows CE operating system



**BIESSEARTECH**

Home

Compositions

Basic MC

NC

Units

Layout



# WORKING UNITS



**BIESSE**

# Jade 300: working units

WOOD DIVISION

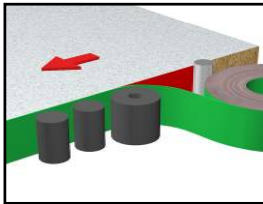

Gluing unit  
VC-511

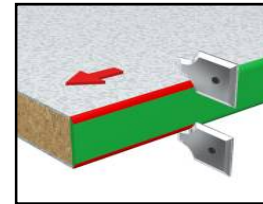

Edge scraper  
RBK-503

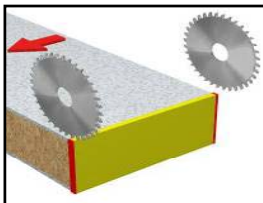

End  
trimming  
unit IN-801

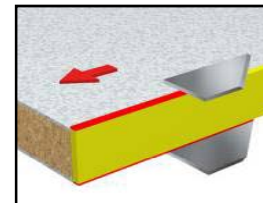

Glue scraper  
RCC-701

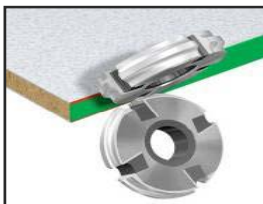

Fine  
trimming unit  
RI-501

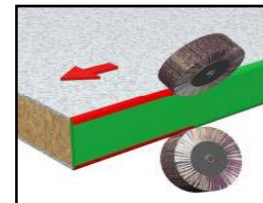

Brushes  
SP-501

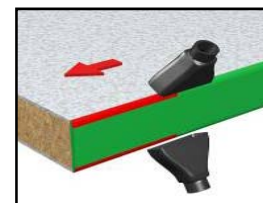

Hot air  
blower  
PH-501

# Working units

WOOD DIVISION

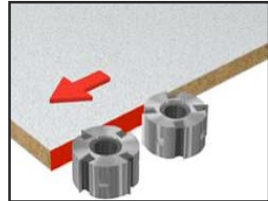

Pre-milling  
unit FI-502

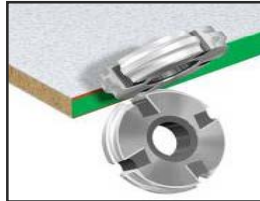

Fine  
trimming unit  
RI-501

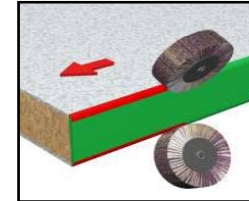

Brushes SP-  
501

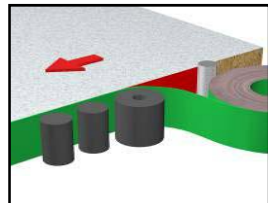

Gluing unit  
VC-511

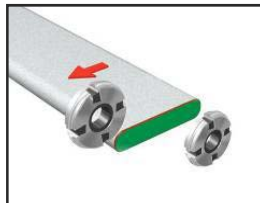

Corner  
rounding unit  
CR-200V

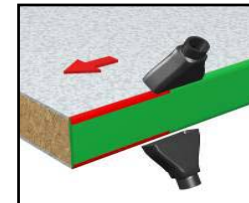

Hot air  
blower  
PH-501

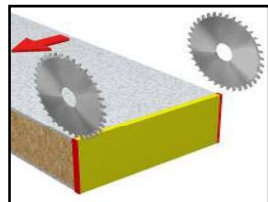

End  
trimming  
unit IN-801

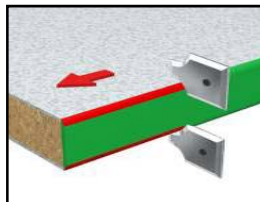

Edge scraper  
RBK-503

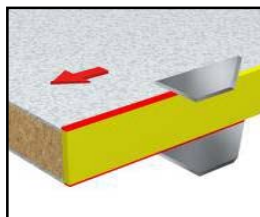

Glue scraper  
RCC-701

## PRE-MILLING UNIT FI-502

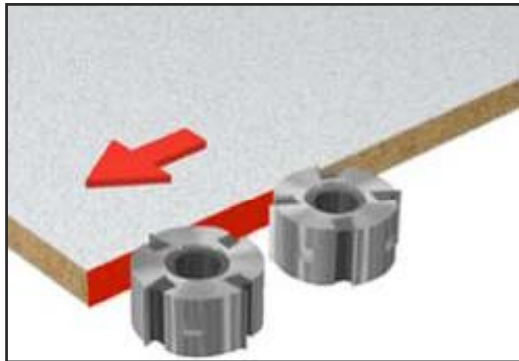

# Jade 300 – Pre-milling unit FI-502

WOOD DIVISION



## CHARACTERISTICS

- 2 motors 3,5 kW at 12000 rpm.
- Mill diameter Ø80mm.
- Standard mills with widia cutters, diamond optional (H 45 o 65 mm)
- Antiadhesive unit for the cleaning of the panel by the glue on the top and bottom surface (opt.).

# Jade 300 – Pre-milling unit FI-502

WOOD DIVISION

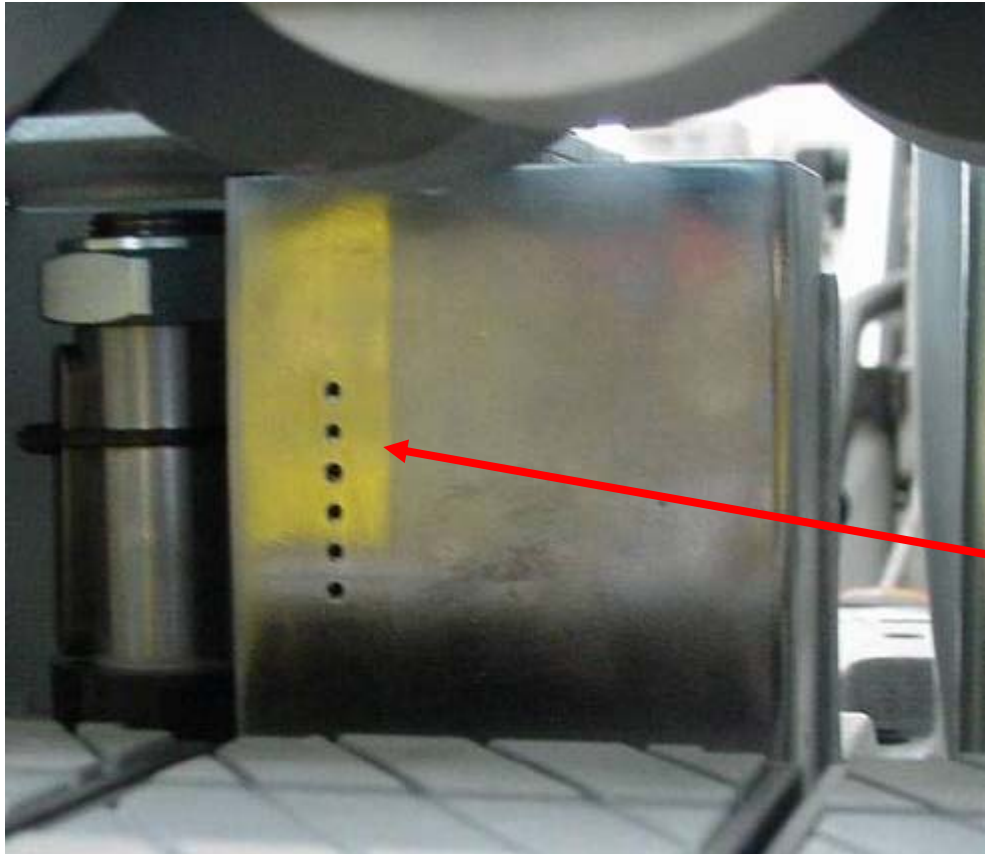

## CHARACTERISTICS

- Shoe copier to keep unchanged the geometry of the work-piece
- Standard suction system on each motors.
- Blower on the second copier to clean panel.

# Jade 300 – Pre-milling unit FI-502

WOOD DIVISION

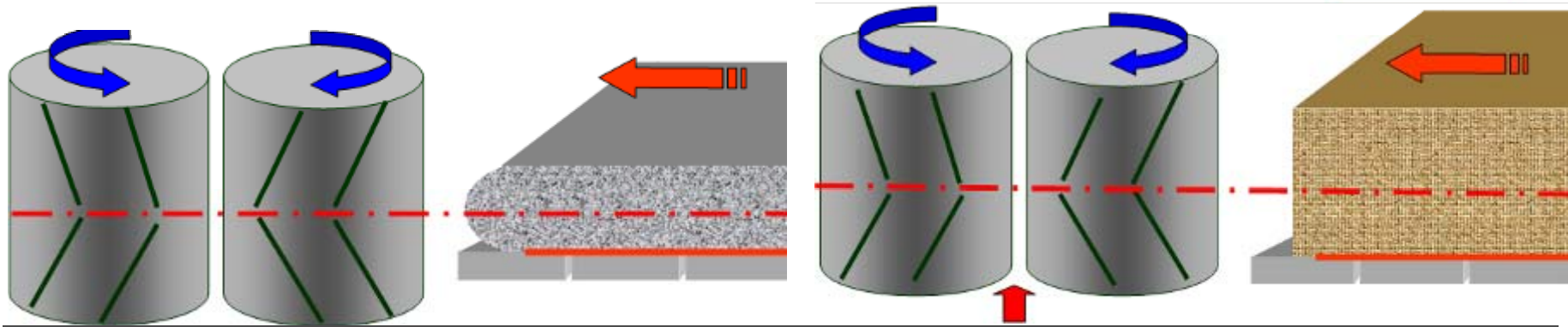

## CHARACTERISTICS

- Standard AUTO-SET system

## CUSTOMER ADVANTAGES

- Don't chip postformat panels
- More uniform wear on the cutter height

# GLUING UNIT VC-511

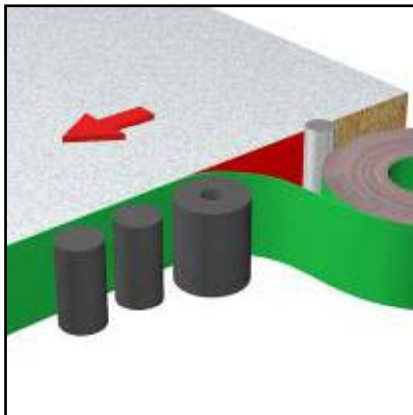



# Jade 300 – Gluing unit VC-511

WOOD DIVISION

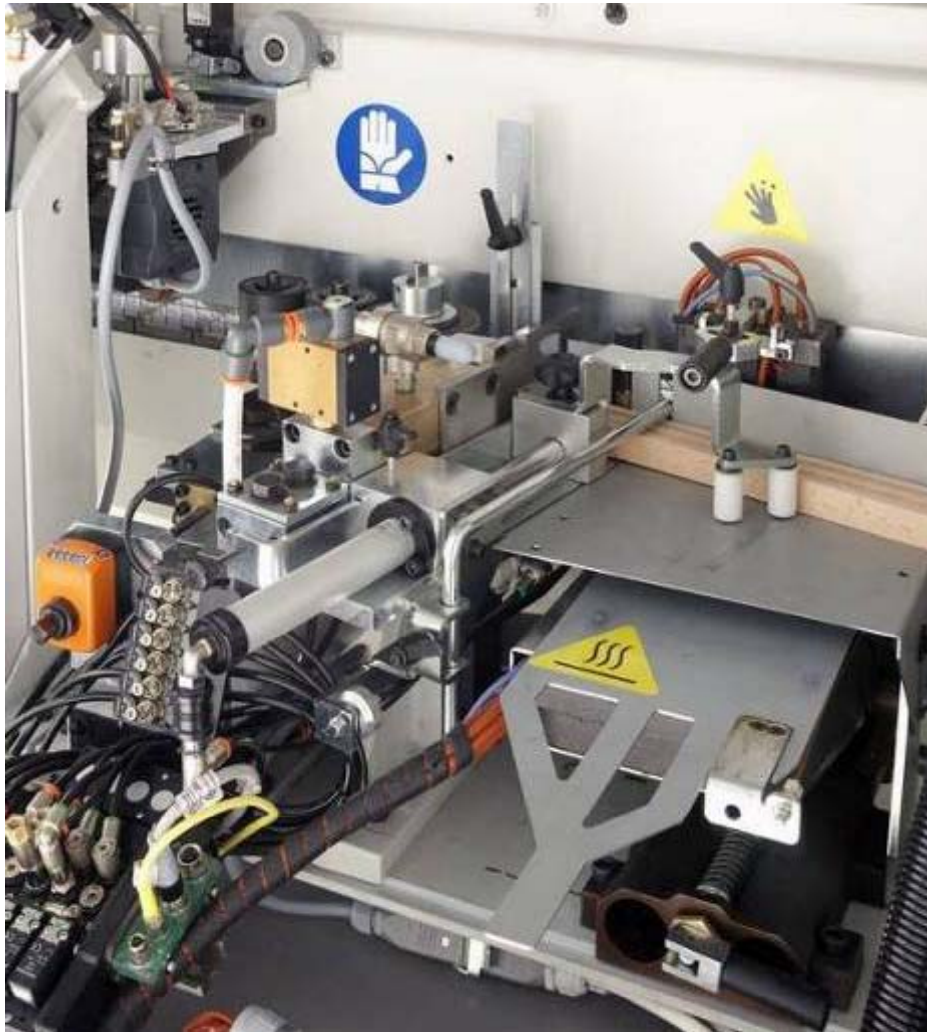

## CHARACTERISTICS

- **Automatic loading** for edge-banding in rolls and in strips on Jade 335/340
- Manual loading for strips on Jade 320/325
- 1 big diameter motorized and clutched roll + 2 small idle rolls.

# Options for the VC-511 in the NC machine



## INFRARED LAMP

### CHARACTERISTICS

- It heats the panel before the glue is applied

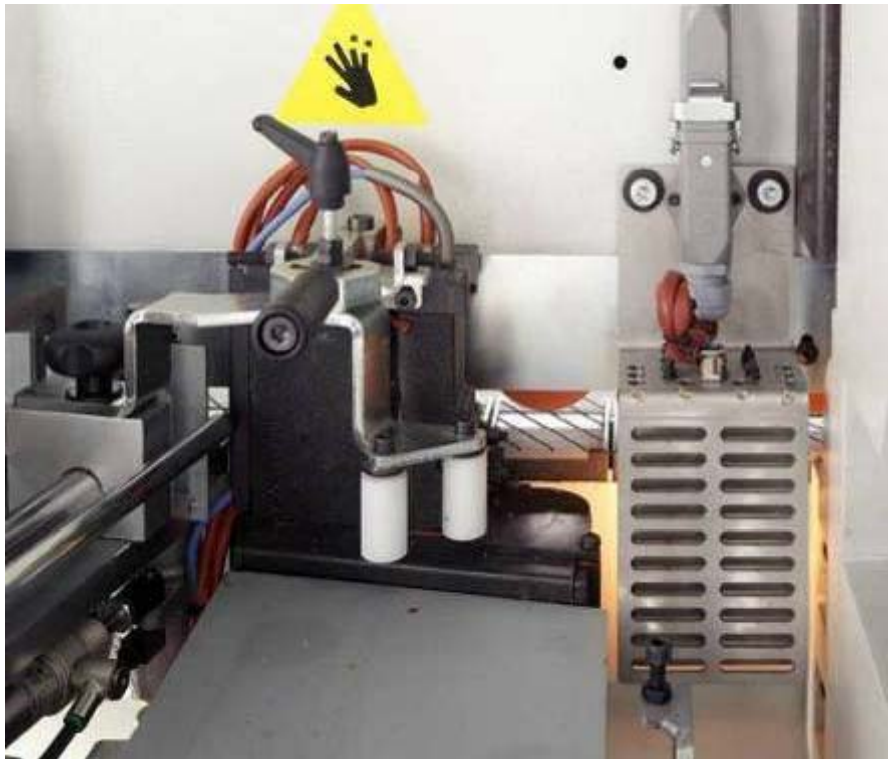

### CUSTOMER ADVANTAGES

- Remove the humidity
- Decrease the different temperature between panel and glue

Not available on Jade 320– 325

# END TRIMMING UNIT IN-801

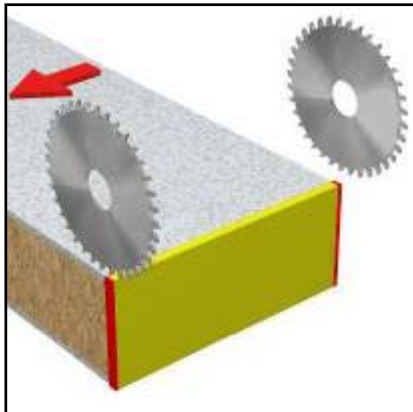

# Jade 300 – End trimming unit IN-801

WOOD DIVISION



## CHARACTERISTICS

- Two high frequency motors 12000 rpm 0.8 KW.
- Pneumatic tilting from CN (std)
- FLEX system (std on Jade 335 - 340)
- Dust extraction + bulkhead (std)
- Motor exclusion from CN (std)

# Jade 300 – End trimming unit IN-801



Slide on linear guides with ball blocks

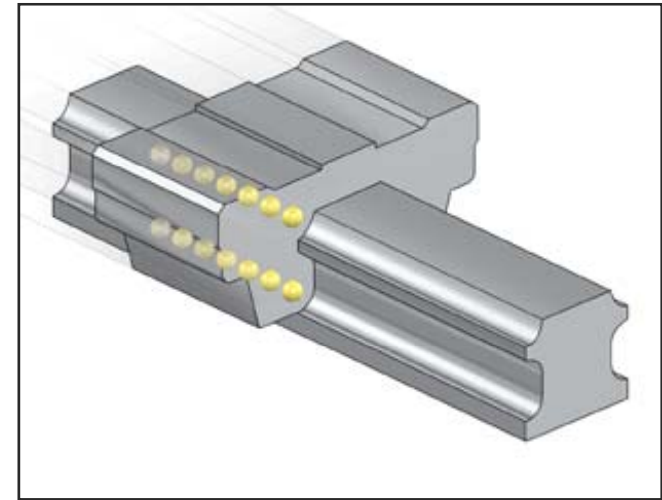
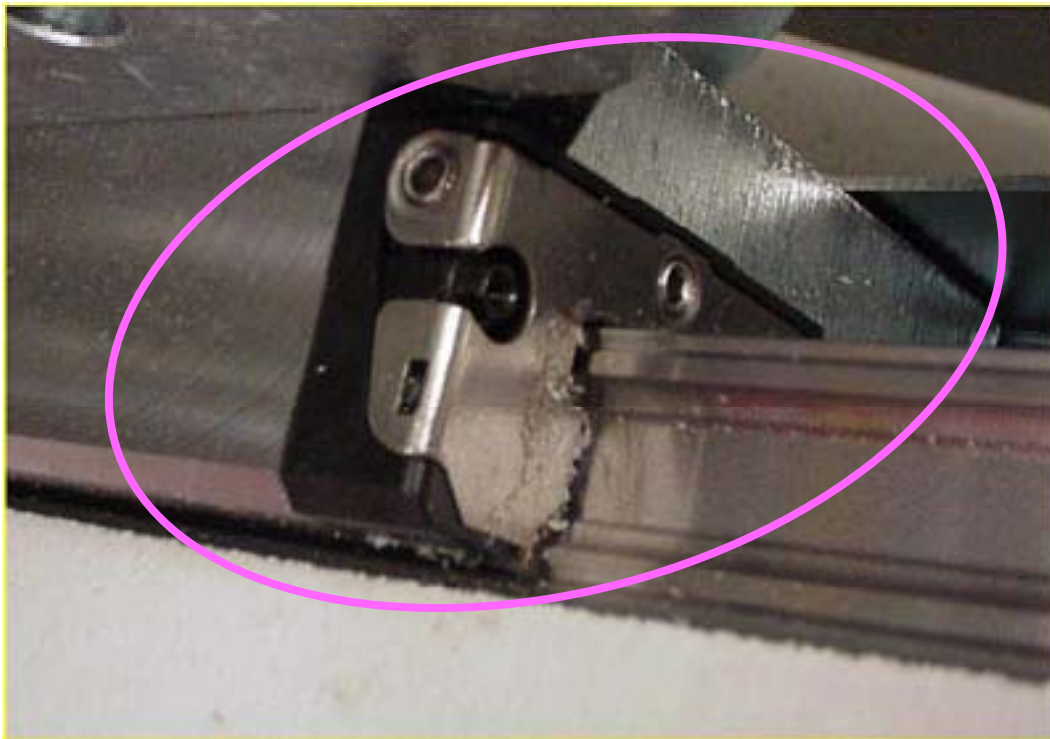

# Jade 300 – End trimming unit IN-801

WOOD DIVISION

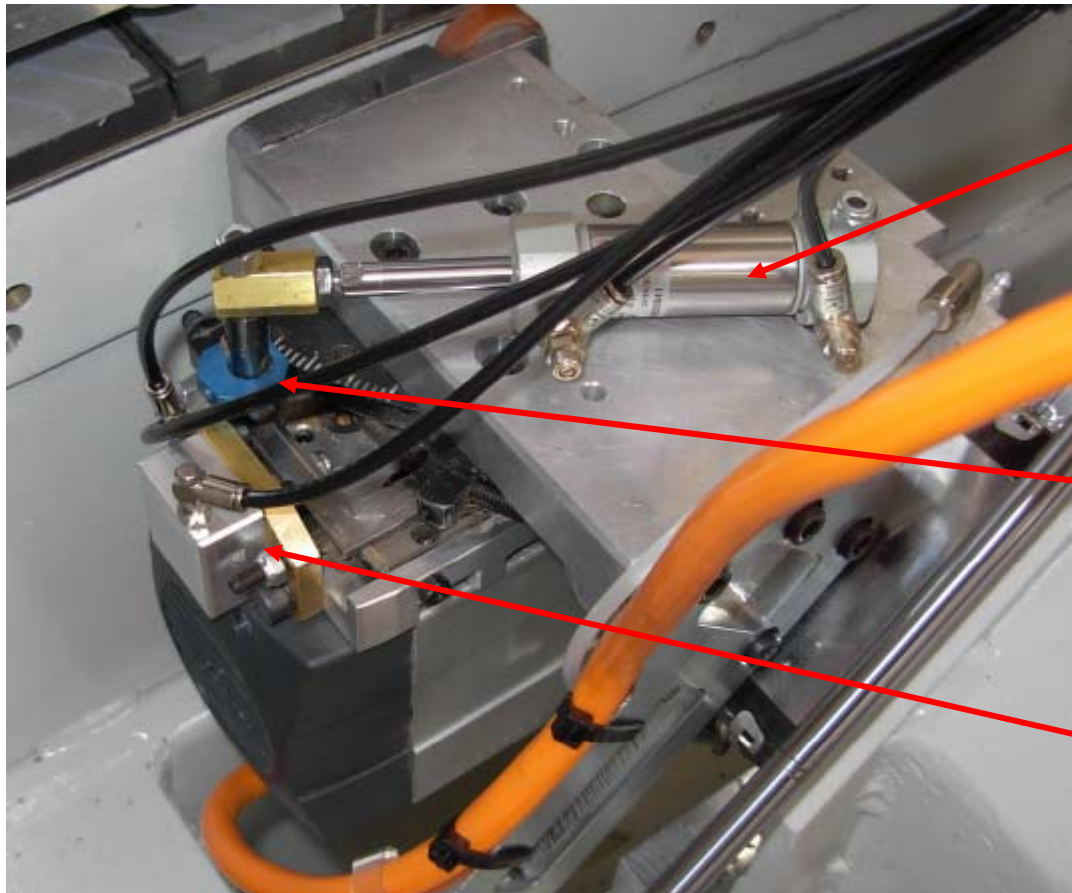

Pneumatic tilting can be set in two position, (adjustable) with blocking mechanism integrated.

Tilting 0-15.°  
Cutting angle on graduated staircase.

FLEX system at double position.

# Jade 300 – End trimming unit IN-801

WOOD DIVISION

End trim tilting blades from CN at double position.

1<sup>st</sup> passage  
Straight cut



2<sup>nd</sup> passage  
Tilted cut (e.g. 3,6° )

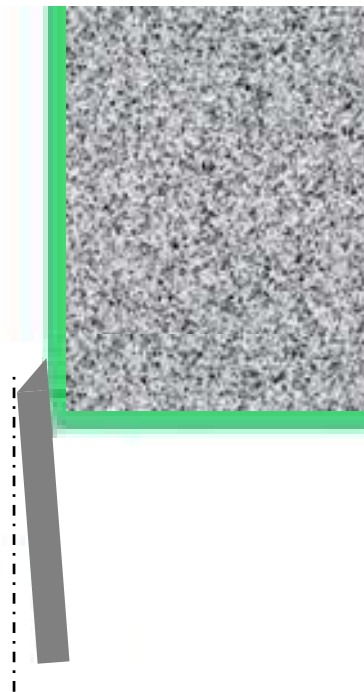

# Jade 300 – End trimming unit IN-801

WOOD DIVISION

## CHARACTERISTICS

- The FLEX function allows easy post formed panels machining

## CUSTOMER ADVANTAGES

- Machining without having manually lining
- Higher workmanship quality

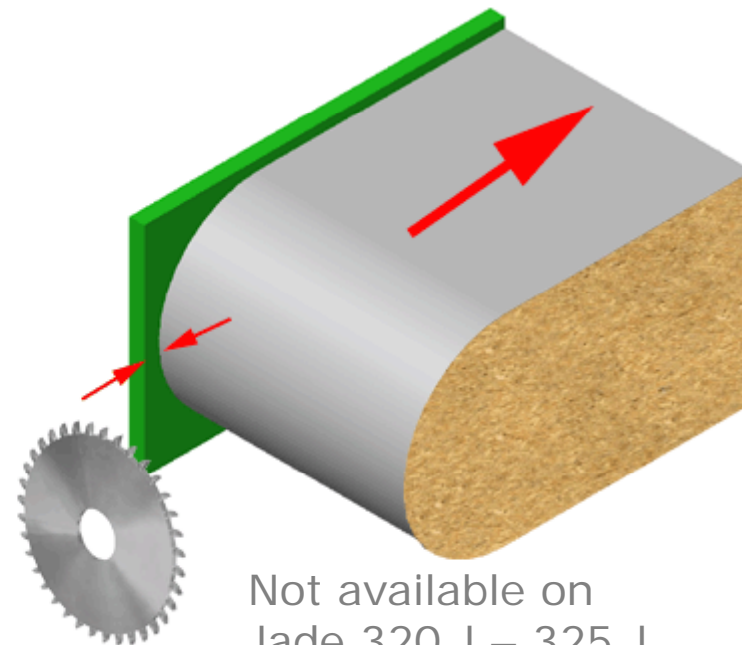
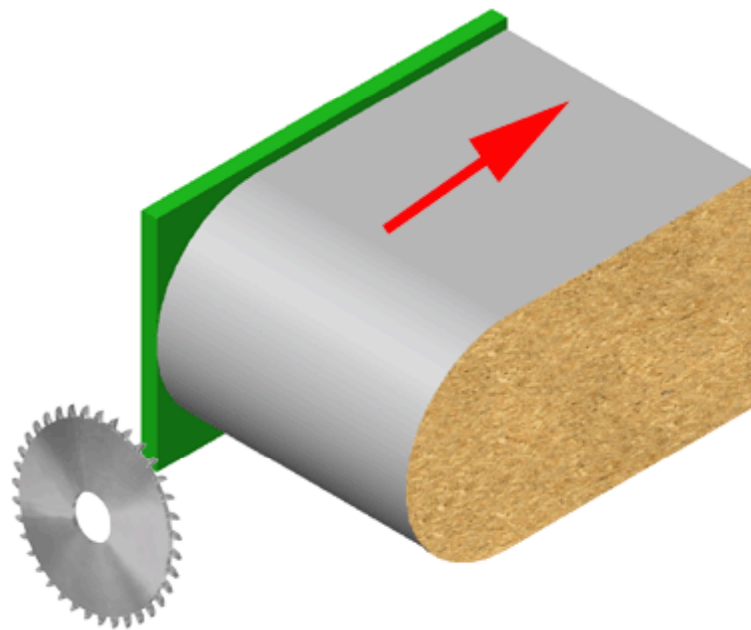

Not available on  
Jade 320 J – 325 J



# Jade 300 – End trimming unit IN-801

WOOD DIVISION

## CHARACTERISTICS

- Hoods integral with motors + bulkhead std.

## CUSTOMER ADVANTAGES

- Very efficient suction system

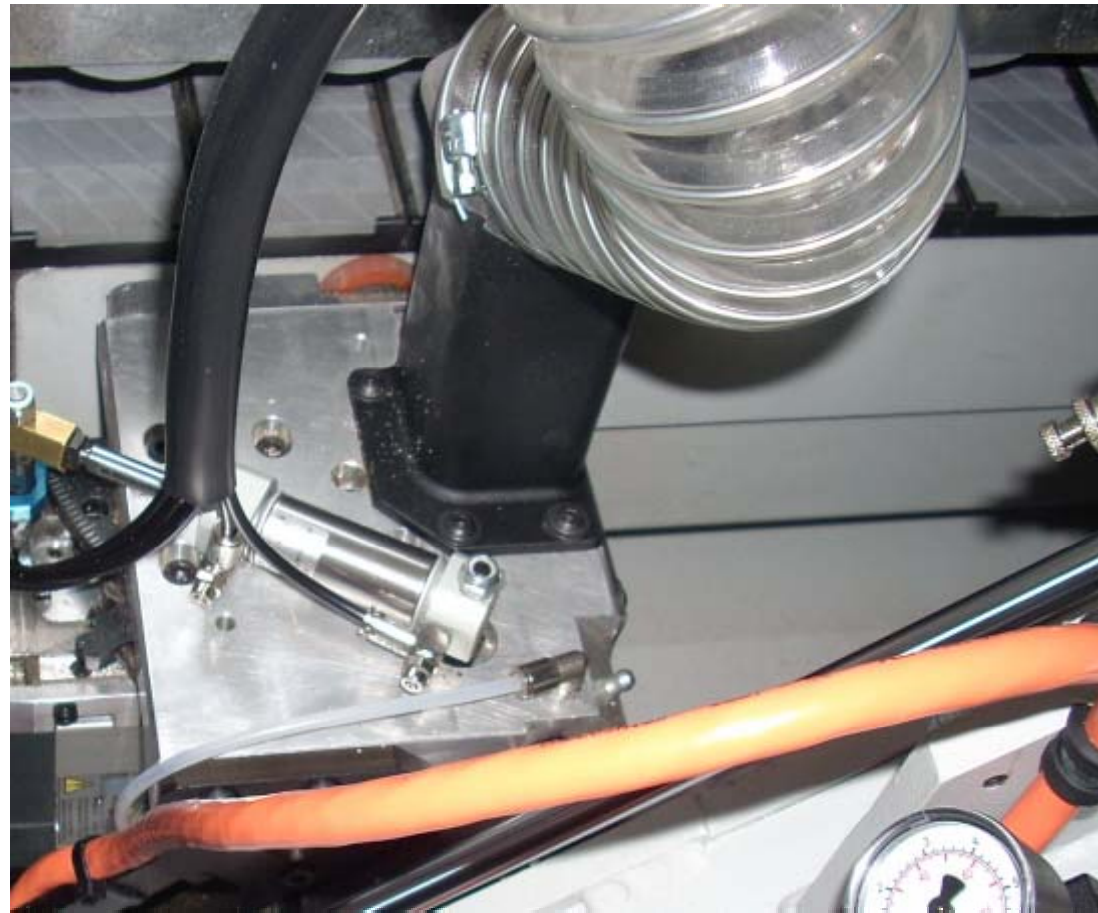

Jade 300

*Easy Tech*

WOOD DIVISION

## TILTING TOP AND BOTTOM TRIMMING RI-501

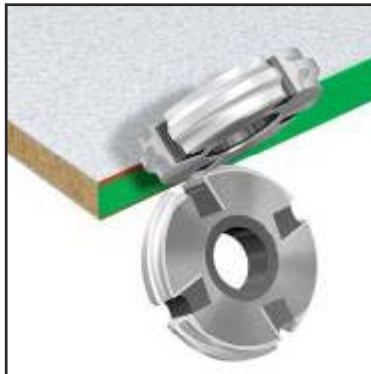

**BIESSEARTECH**

[Home](#)

[Compositions](#)

[Basic MC](#)

[NC](#)

[Units](#)

[Layout](#)

# Jade 300 – Tilting trimming unit RI-501

WOOD DIVISION

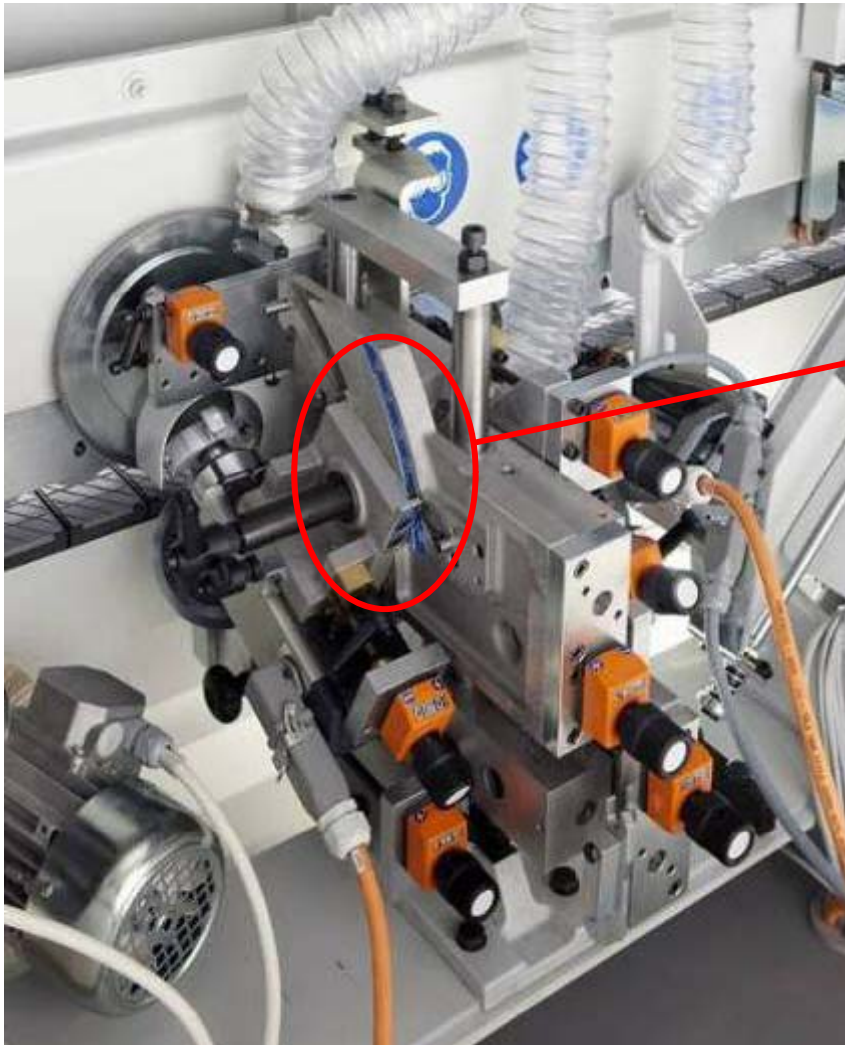

## CHARACTERISTICS

- Two high frequency motors 0,65 kW at 12000 rpm.
- Tilting motors from 0 up to 25 degrees
- Complete with 8 numerical indicators for manual settings.
- Main movement on round guides hardened and grinded guides with ball bushing.

# Jade 300 – Tilting trimming unit RI-501

WOOD DIVISION

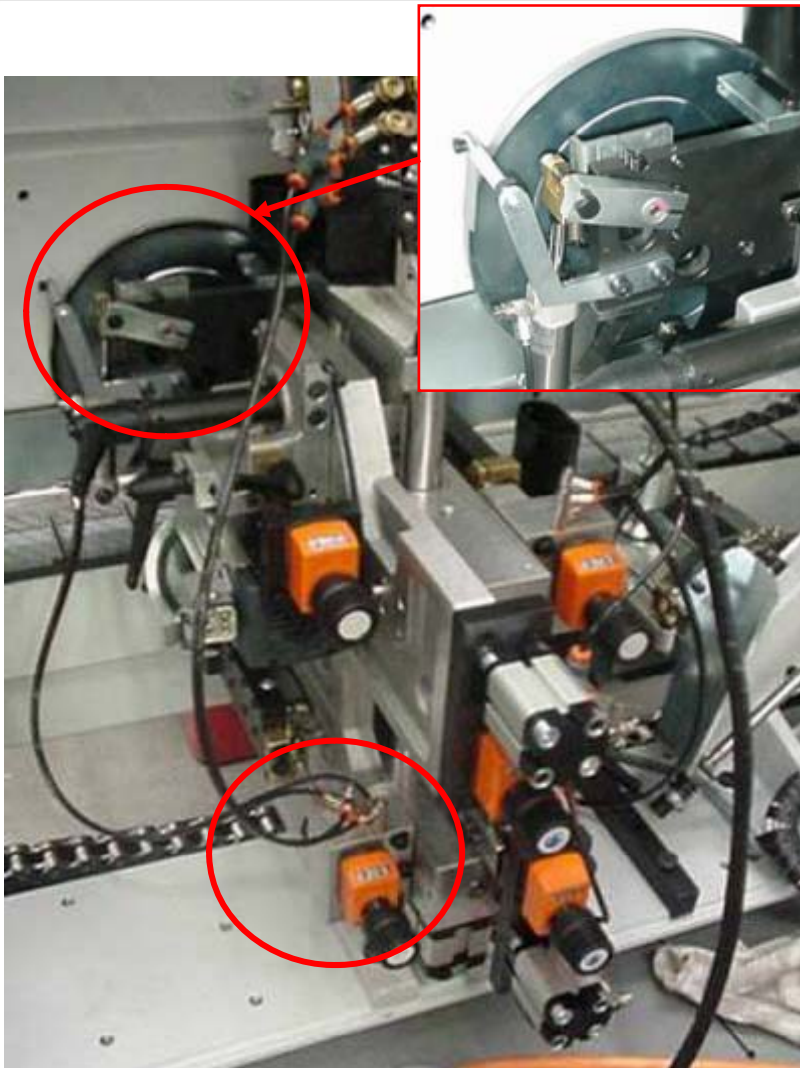

## FAST 2

**Workmanship change** fast and precise between thin and thick edges (e.g. 0,4 mm - 2 mm) from panel control (opt.)

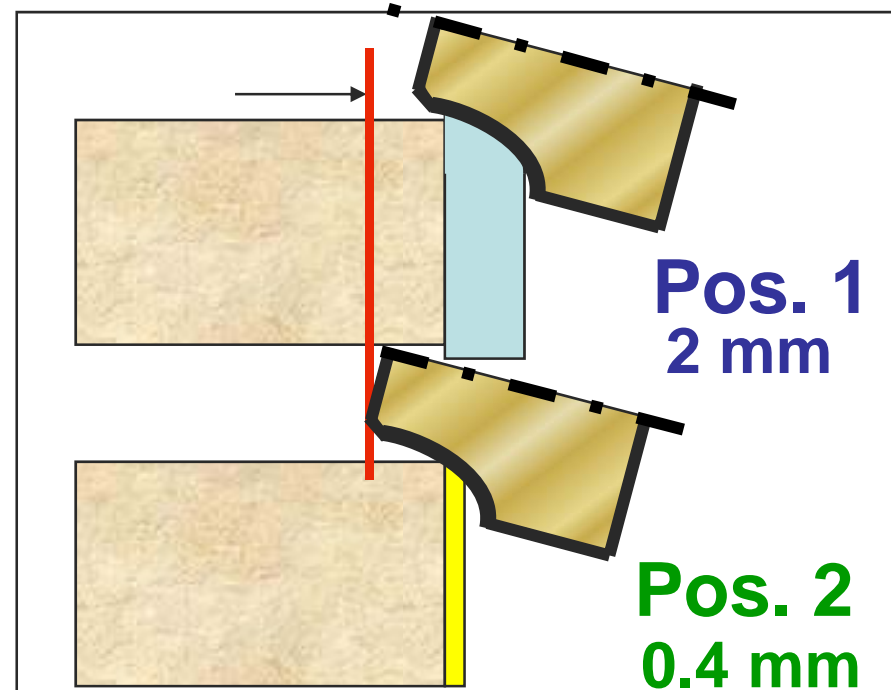

Jade 300

*Easy Tech*

WOOD DIVISION

## 2 MOTORS CORNER ROUNDING UNIT CR-200V

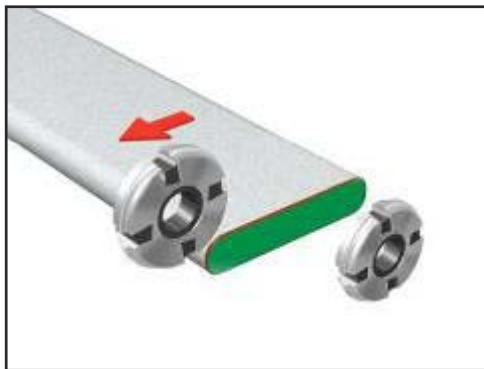

**BIESSEARTECH**

[Home](#)

[Compositions](#)

[Basic MC](#)

[NC](#)

[Units](#)

[Layout](#)

# Jade 300 – Corner rounding unit CR-200V

WOOD DIVISION

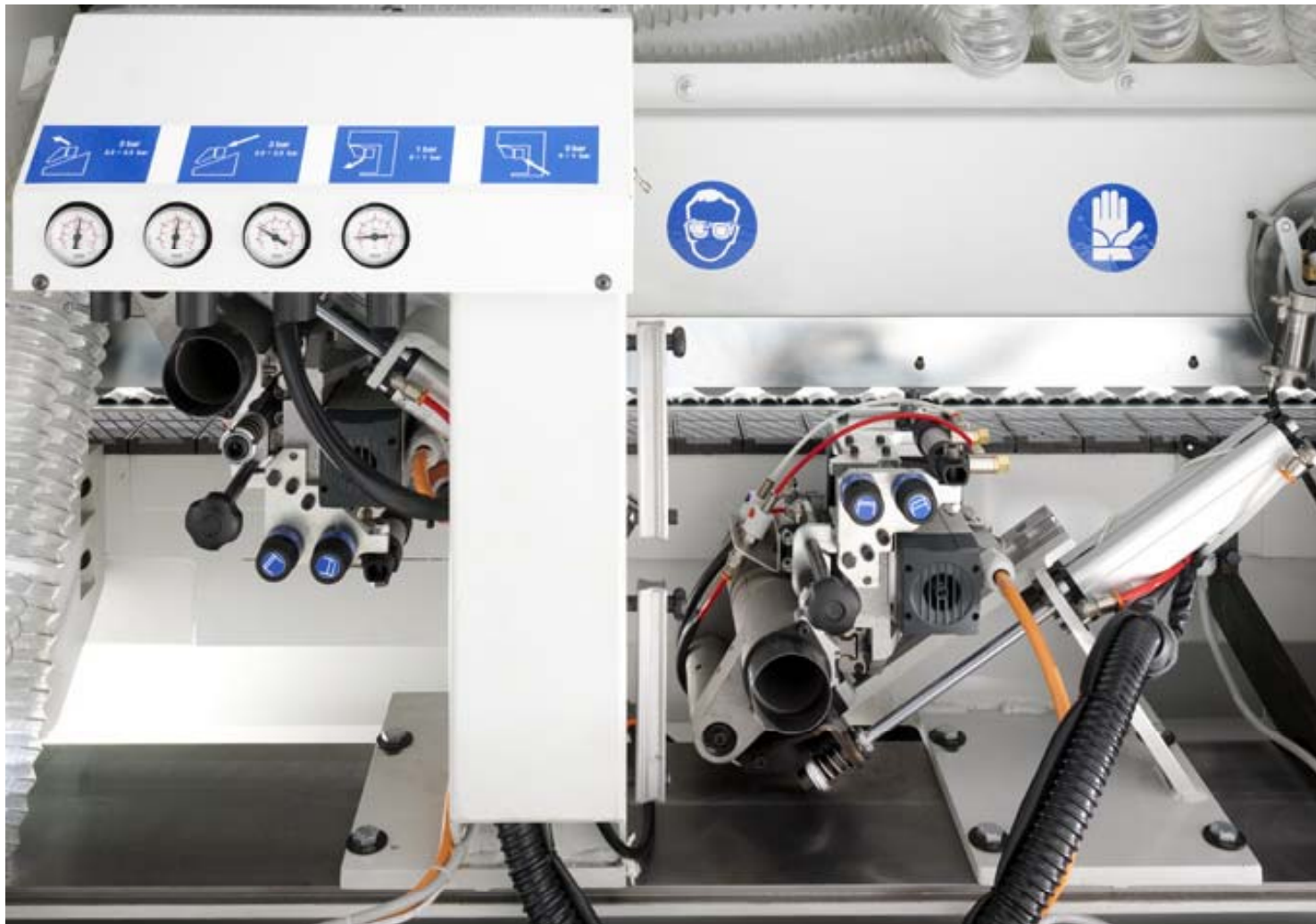

**BIESSEARTECH**

[Home](#)

[Compositions](#)

[Basic MC](#)

[NC](#)

[Units](#)

[Layout](#)

# Jade 300 – Corner rounding unit CR-200V



## CHARACTERISTICS

- Two high frequency motors 0,65 kW at 12000 rpm.
- Conical braze-welded cutters 25 degrees (Z6) or radius cutters with disposable knives Z4.
- Pneumatic exclusion from NC standard.
- **Max panel thickness 60 mm**

# Jade 300 – Corner rounding unit CR-200V



The CR-200V is multifunctional because :

- As standard, it makes the rounding and the trimming of the glued edge
- It allows the fast change from the trimming of 3 different thin edge to the radius trimming (ex. 0,4 – 0,6 – 0,8 – 2 mm)



# Jade 300 – Corner rounding unit CR-200V



## MULTIFUNCTION

## CUSTOMER ADVANTAGES

- With the same functions, the machine has a lower price (it's possible to eliminate one trimming unit)
- It reduces the set-up time when working the radius edge (otherwise it's COMPULSORY to join the radius done by the corner rounding unit)
- It allows the fast change without tests from the trimming of thin edge to the trimming of a edge with radius

## RIGHT USE of CR-200V

1. The maximum edge overhang allowed is 1,5/2 mm.

2. NOT SUITABLE for the machining of wooden edges

3. Changing from the rounding of panels with straight outline to panel with shaped outline (post/soft formed) could be necessary to make fine adjustments due to the different panels consistency in the machined points.

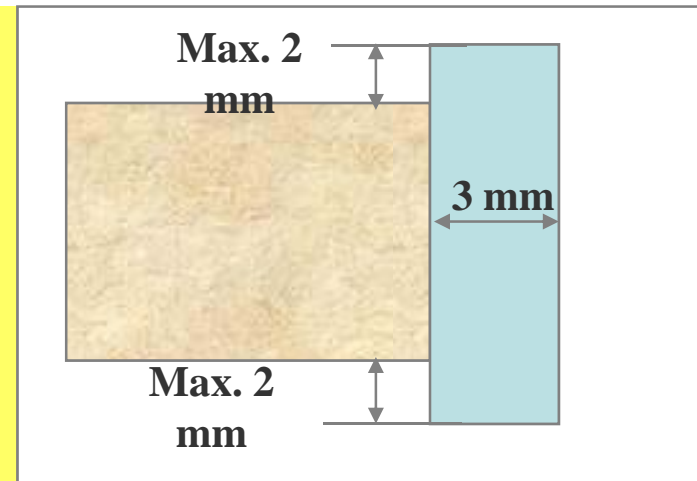

# Jade 300 – Corner rounding unit CR-200V



## CUSTOMER ADVANTAGES

- ROUNDING of panels with straight outline and soft/post formed panels
- TRIMMING of panels edged with synthetic materials with a maximum thickness of 3mm.
- **MACHINING CHANGE** between thin and thick edges fast and precise (e.g. between 0,4 mm and 2 mm) thanks to the on board **4 positions FAST** controlled from the NC (**std.**).
- **SET-UP** fast and precise with pneumatic positioning
- HIGH EFFICIENCY **DUST EXTRACTION** system

# Jade 300 – Corner rounding unit CR-200V

WOOD DIVISION

Functions that can be done WITHOUT manual set-up

✓ 1	TRIMMING	THIN EDGE
✗ 2	ROUNDING	THIN EDGE
✓ 3	TRIMMING	3 mm EDGE
✓ 4	ROUNDING	3 mm EDGE

# Jade 300 – Corner rounding unit CR-200V

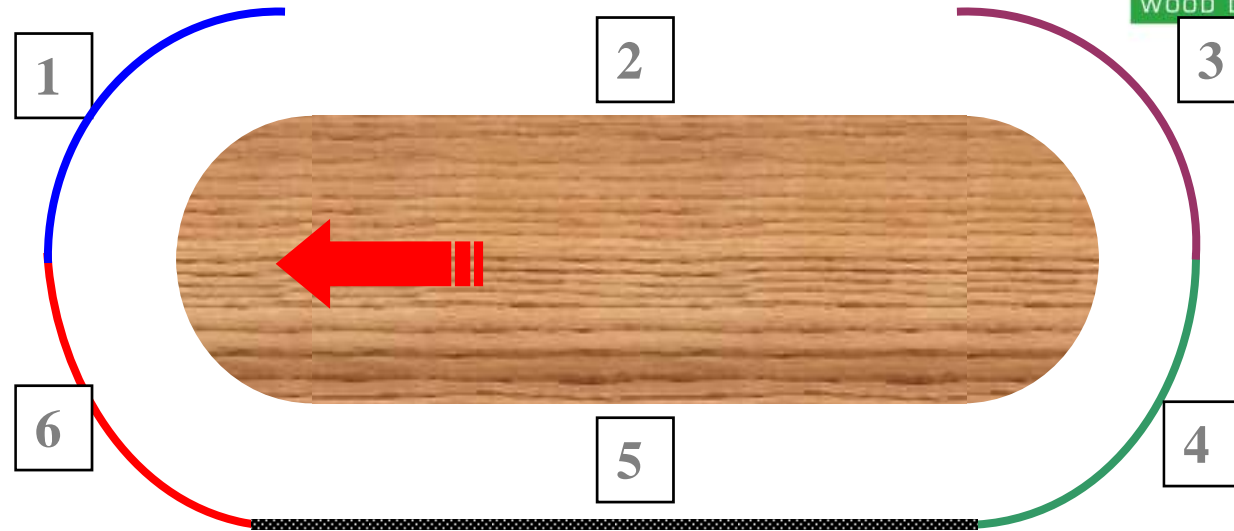

## Allowed combinations

**TOP MOTOR:** machining 2; machining 1+2; machining 2+3; machining 1+2+3.

**BOTTOM MOTOR:** machining 5; machining 5+ 6; machining 4+5;  
machining 4+5+6.

# Jade 300 – Corner rounding unit CR-200V

WOOD DIVISION

ROUNDING of SYNTETIC edges 2 or 3 mm thick  
glued on straight outlined panels

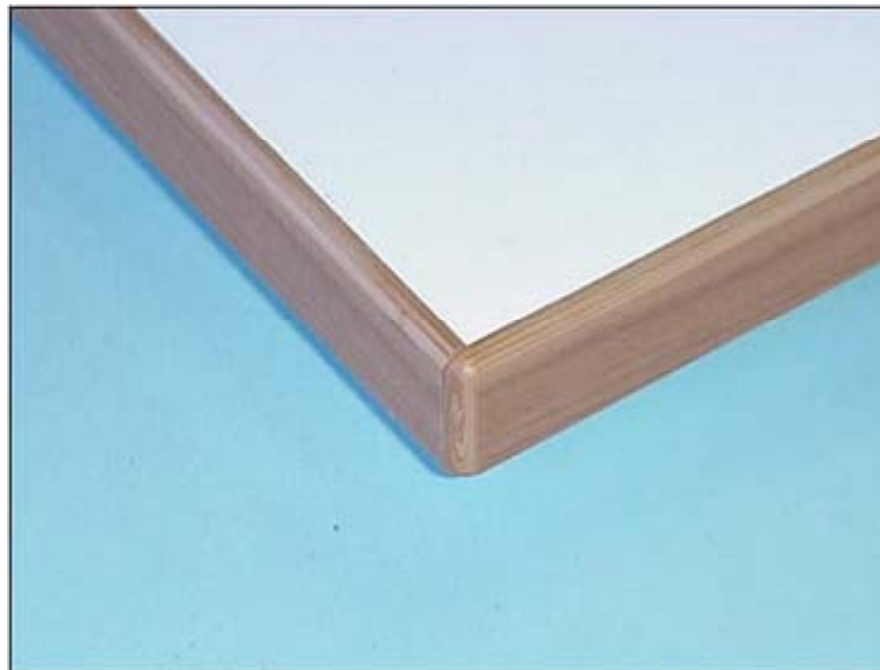

# Jade 300 – Corner rounding unit CR-200V

WOOD DIVISION

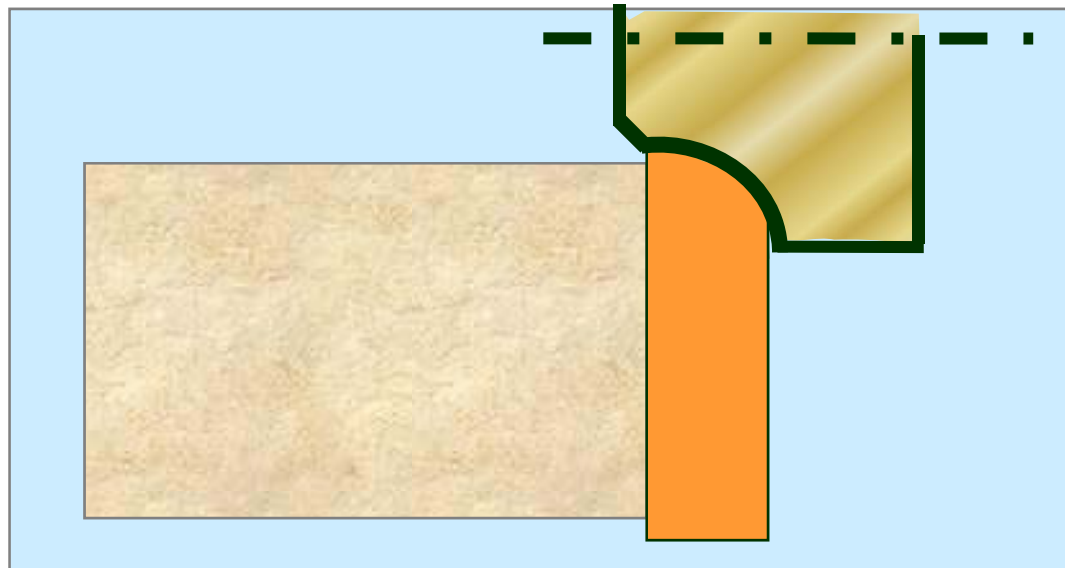

Edge trimming  
on thick edge

With radius cutter

# Jade 300 – Corner rounding unit CR-200V

WOOD DIVISION

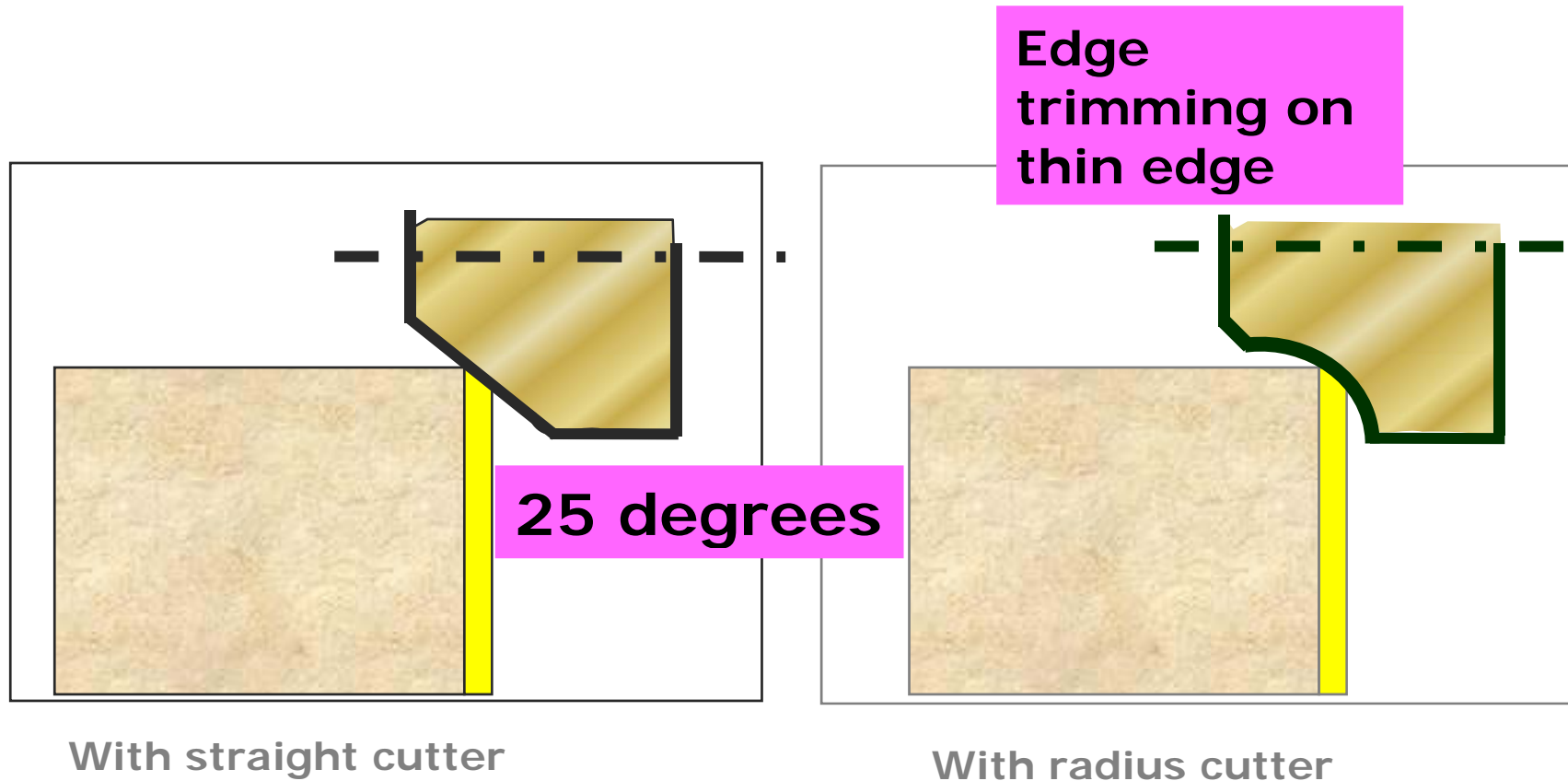



# Jade 300 – Corner rounding unit CR-200V



4 POSITIONS FAST (std)

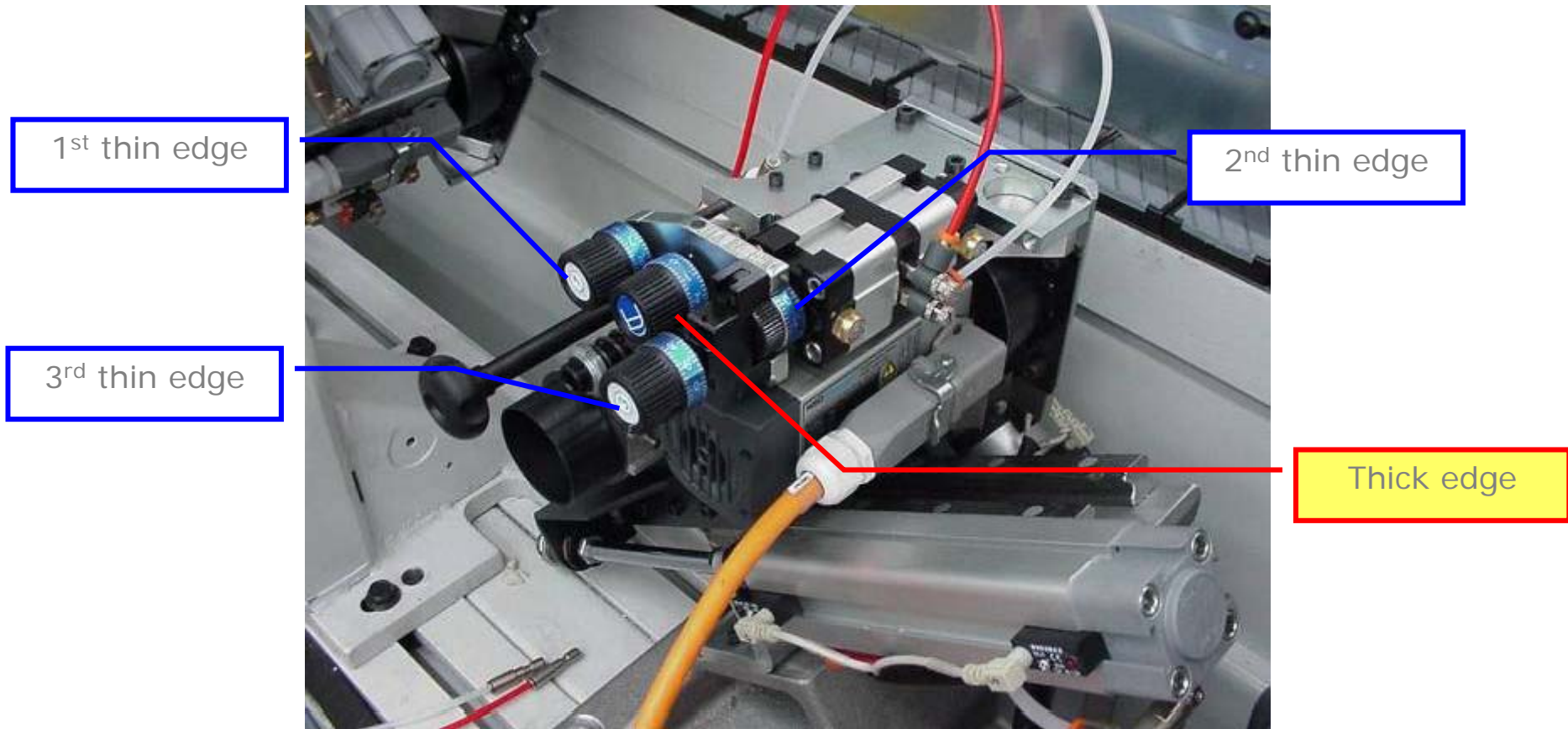

# Jade 300 – Corner rounding unit CR-200V



## MACHINING CHANGE

fast and precise between **3** different thin edges e 1 thick edge (e.g. between 0,4-0,6-0,8 mm e 2 mm) with **4 positions FAST system (std)**.

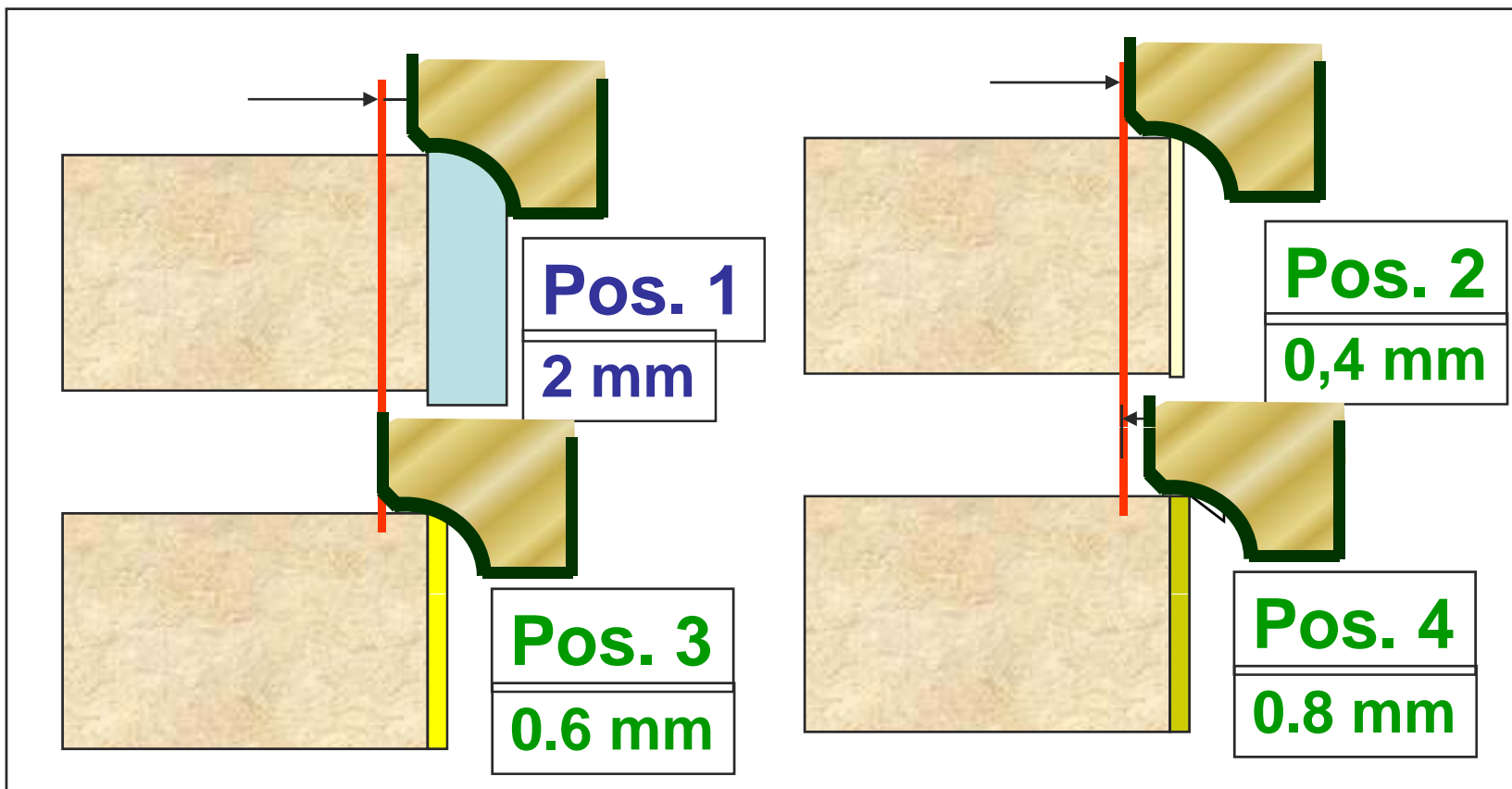

# Jade 300 – Corner rounding unit CR-200V

WOOD DIVISION

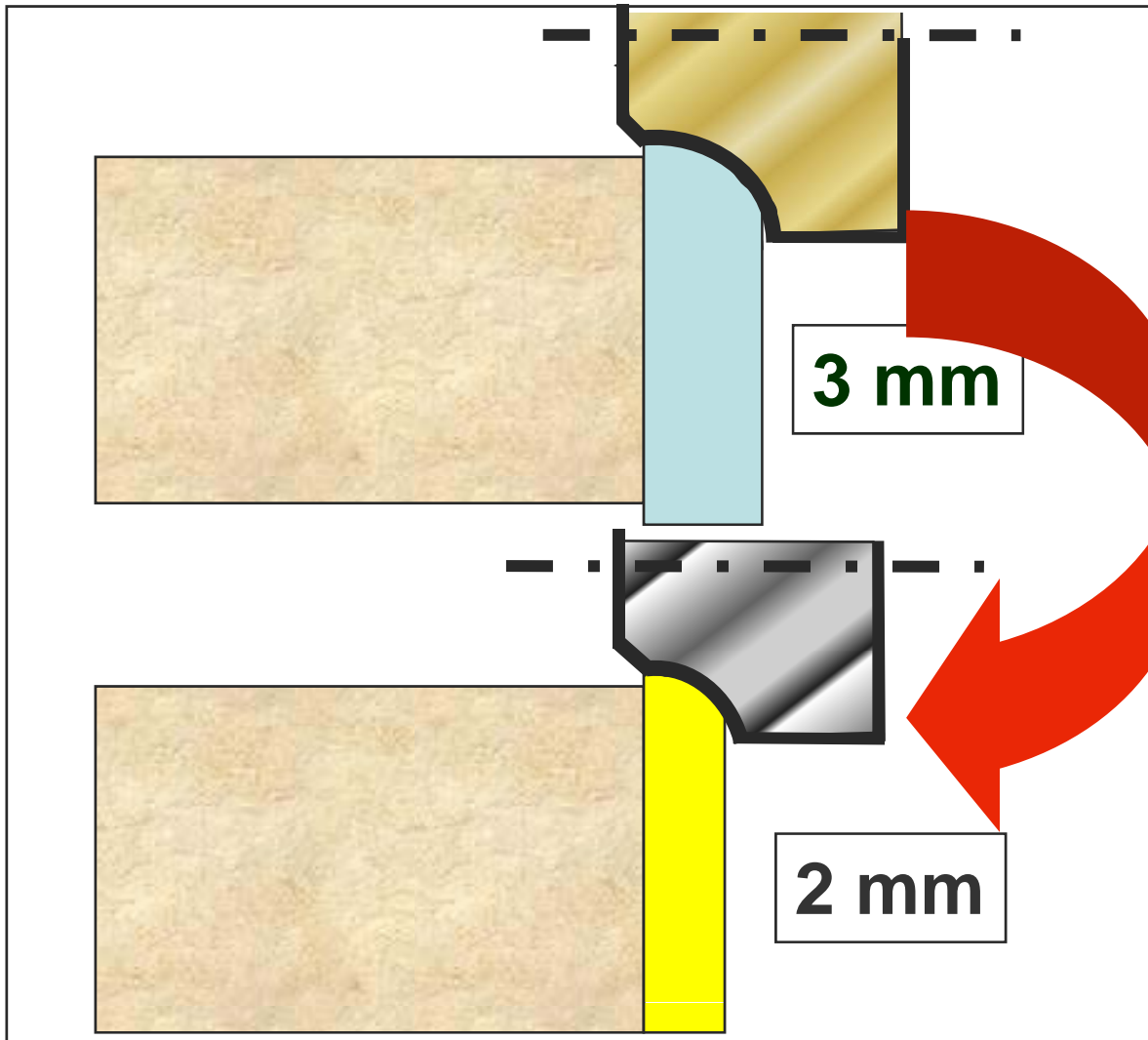

3 mm

2 mm

**MACHINING CHANGE**  
fast and precise between  
2 different thick edges  
(e.g. between 2 and 3  
mm) **(Optional)**

**FAST  
MOTORS  
CHANGE**

# Jade 300 – Corner rounding unit CR-200V

WOOD DIVISION



## CHARACTERISTICS

- Forced air cooling throughout all the motor length.

## CUSTOMER ADVANTAGES

- High reliability and duration

# Jade 300 – Corner rounding unit CR-200V



State of art technology for high-quality finishing thanks to:

1. Movement on linear guides with ball blocks
2. Vertical copier with turning and oscillating discs
3. Vertical copiers with PRE-COPYING system

# Jade 300 – Corner rounding unit CR-200V



## 1. Movement on linear guides with ball blocks

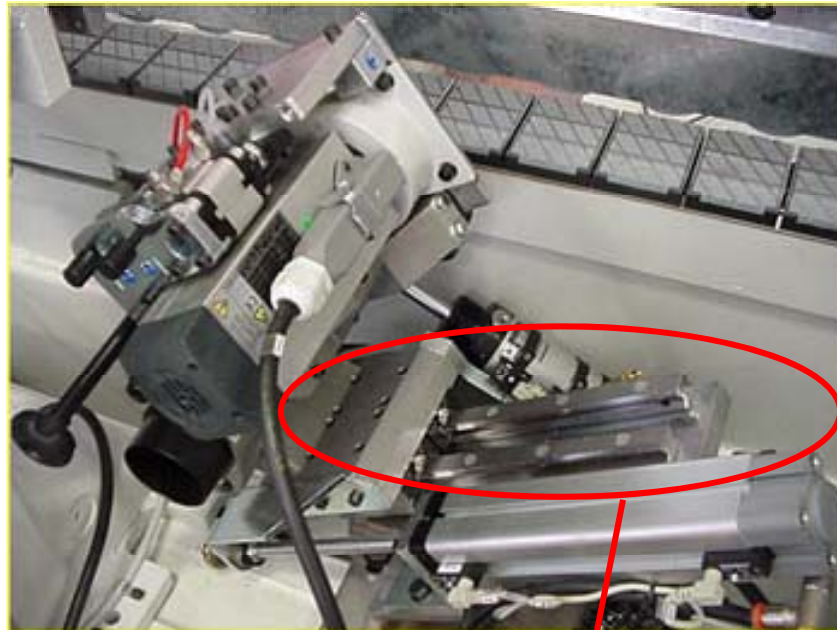

Sliding on linear guide

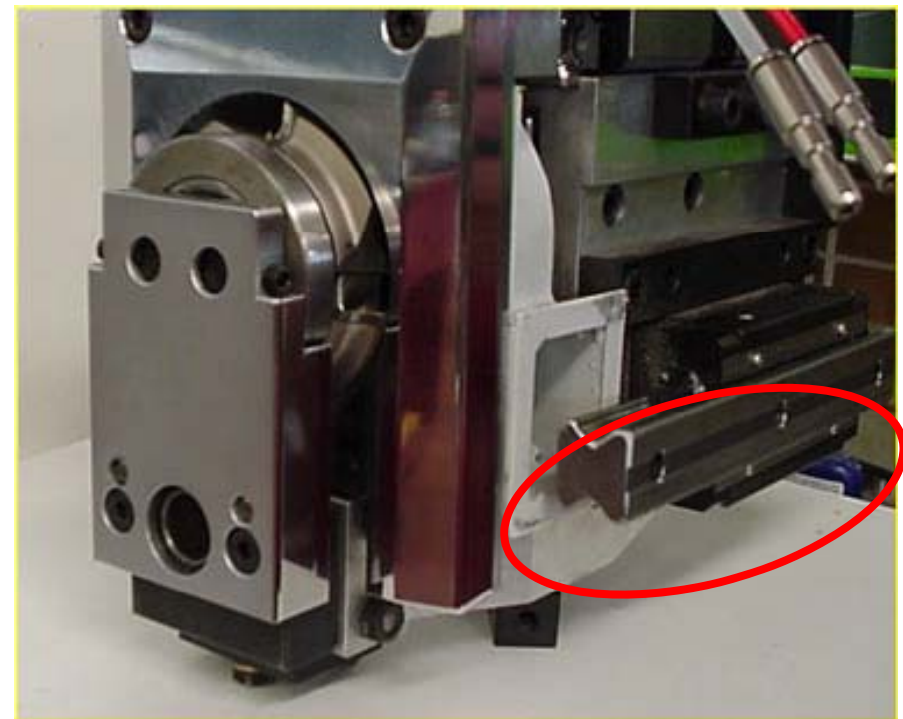

# Jade 300 – Corner rounding unit CR-200V



## 2. Vertical copier with rotating and oscillating discs



# Jade 300 – Corner rounding unit CR-200V



## 2. Vertical copier with rotating and oscillating discs

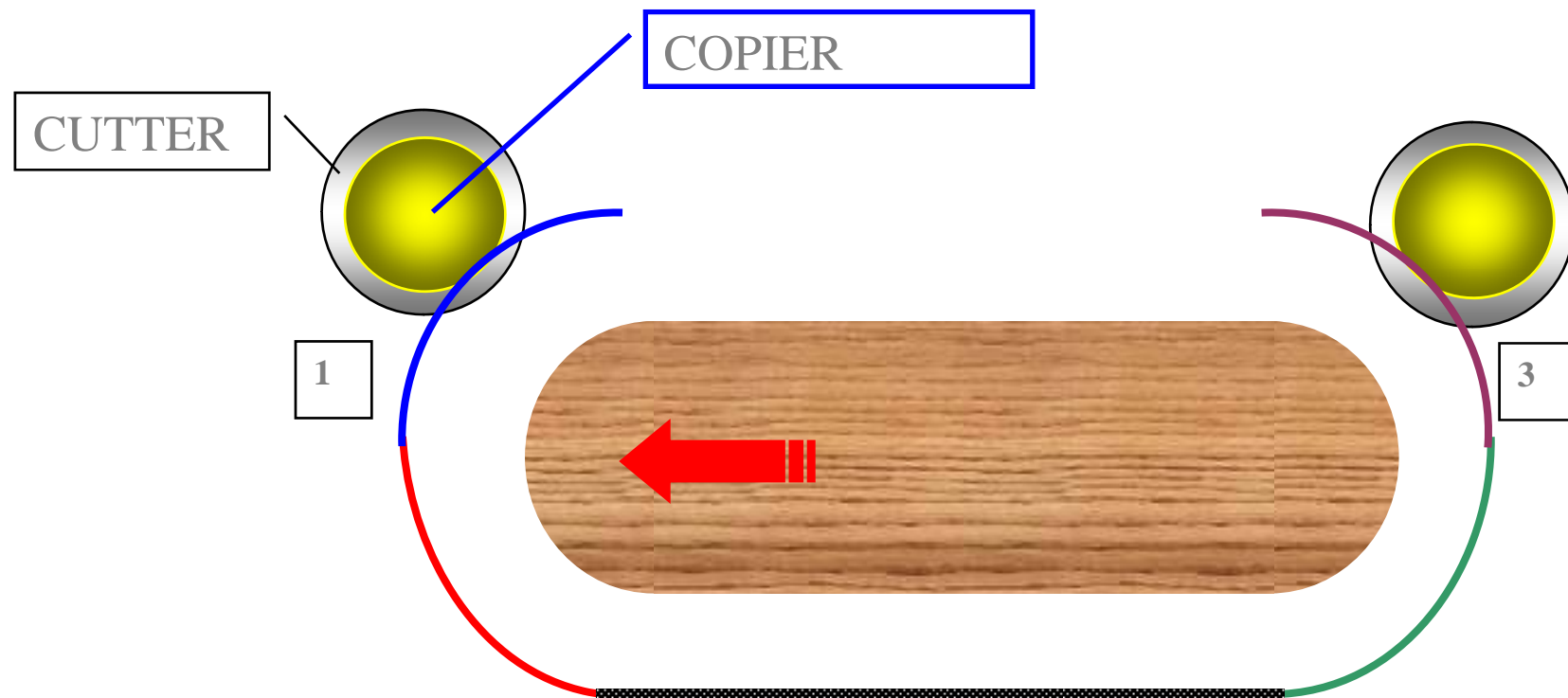



# Jade 300 – Corner rounding unit CR-200V

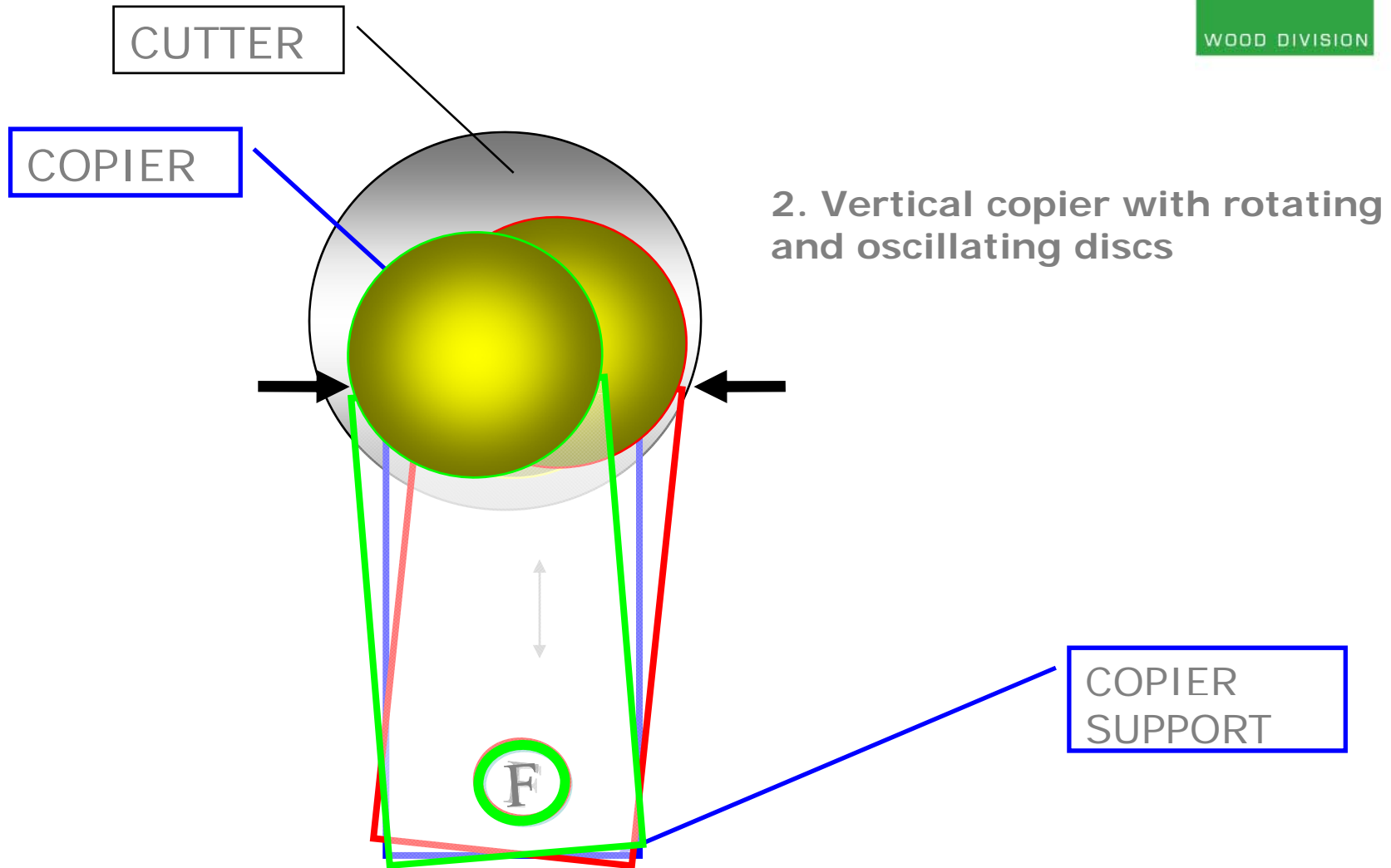

# Jade 300 – Corner rounding unit CR-200V



## 3. Vertical copier with PRE-COPYING system

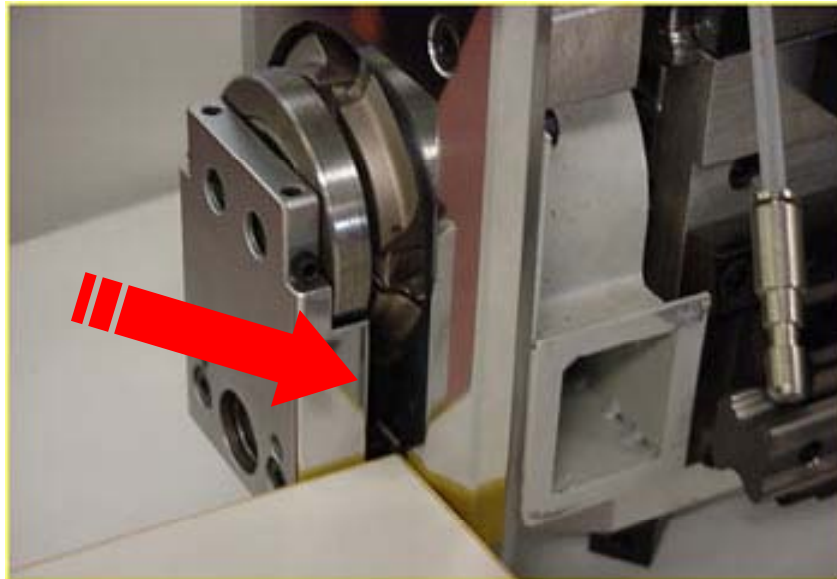

### CHARACTERISTICS

- The contact with the COPIER is far from the machining point to ensure that the panel gets in touch before the tool starts working.

# COMPACT EDGE SCAPER RBK-503

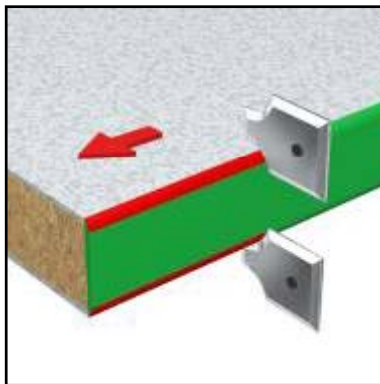

# Jade 300 – Edge scraper RBK-503



## CHARACTERISTICS

- It finishes PVC/ABS edge material (e.g. 2mm)
- Digital mechanic numerators ensure a perfect easily and quickly setting.
- **Frontal and vertical copiers with turning discs.**
- Pneumatic exclusion (std)
- Suction system with chip collection box and blower (std)

# Jade 300 – Edge scraper RBK-503



Chip collection box (standard).

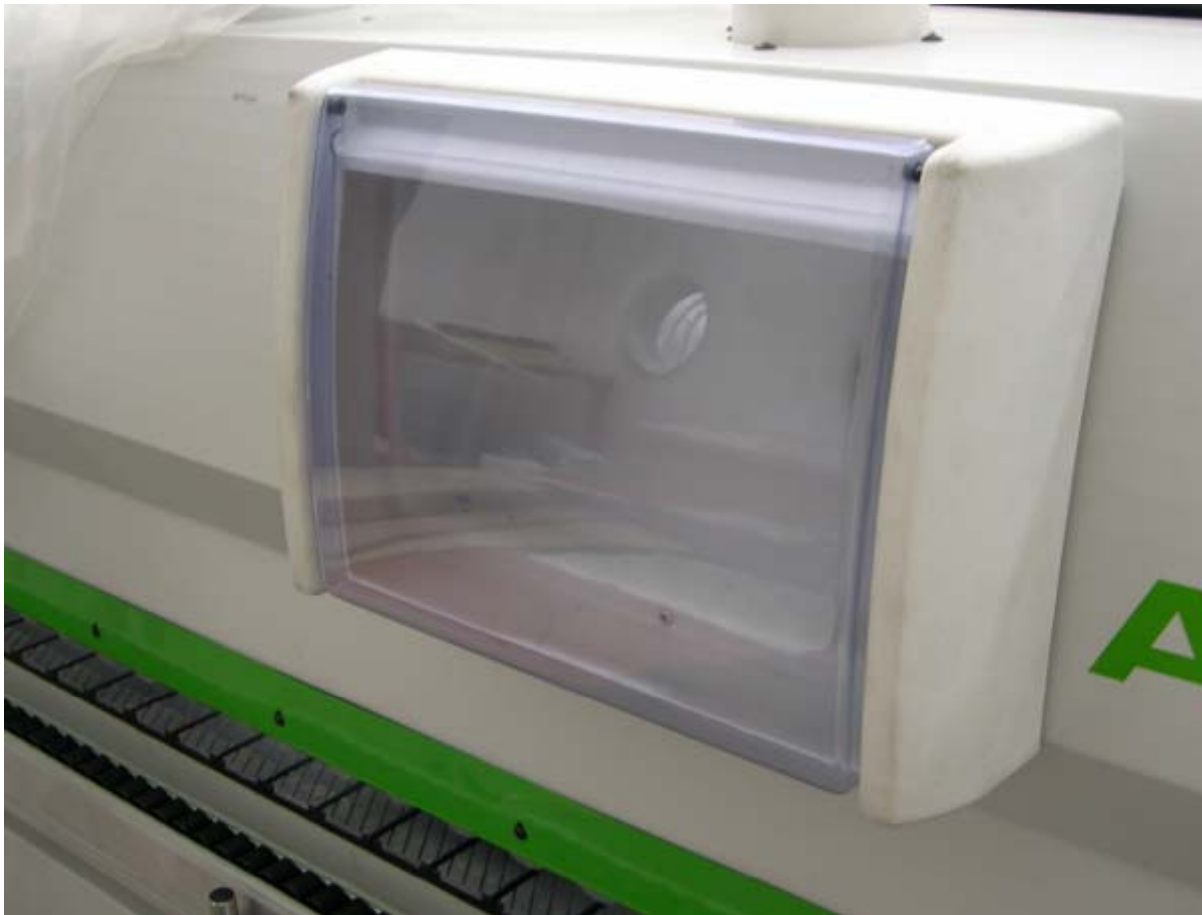

# GLUE SCRAPER RCC-701

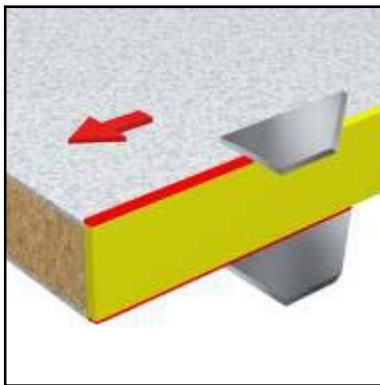

# Jade 300 – Glue scraper RCC-701

WOOD DIVISION



## CHARACTERISTICS

- It removes the eventual glue excesses in the junction edge-panel.
- It has turning disc copiers and the timed intervention is independent from the pneumatic exclusion (standard).
- Dust extraction is standard.

## BRUSHING UNIT SP-501

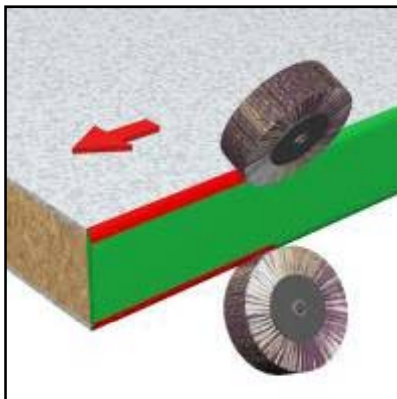



# Jade 300 – Brushing unit SP-501

WOOD DIVISION



## CHARACTERISTICS

- The brushing unit **SP-501** has 2 tilting motors from 0,37 kW.

## CUSTOMER ADVANTAGES

- They get the ideal inclination for the cleaning and polishing of the edge.

# HOT AIR BLOWER PH-501

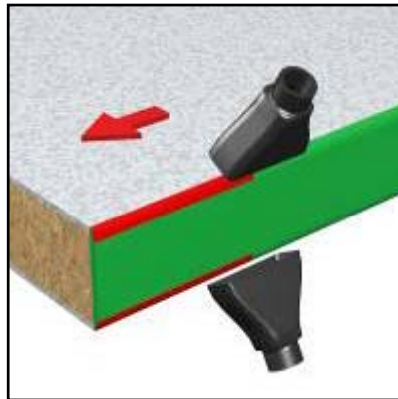

# Jade 300 – Hot air blower PH-501



## CHARACTERISTICS

- The Hot Air Blower **PH-501 (optional)** is equipped by one hot air blower 2 kW of power con 2 conveyors
- **The air temperature is adjustable.**

## CUSTOMER ADVANTAGES

- To reactivate, after the machining, the colour of PVC/ABS edges.



# LAYOUT



**BIESSE**

# Layout

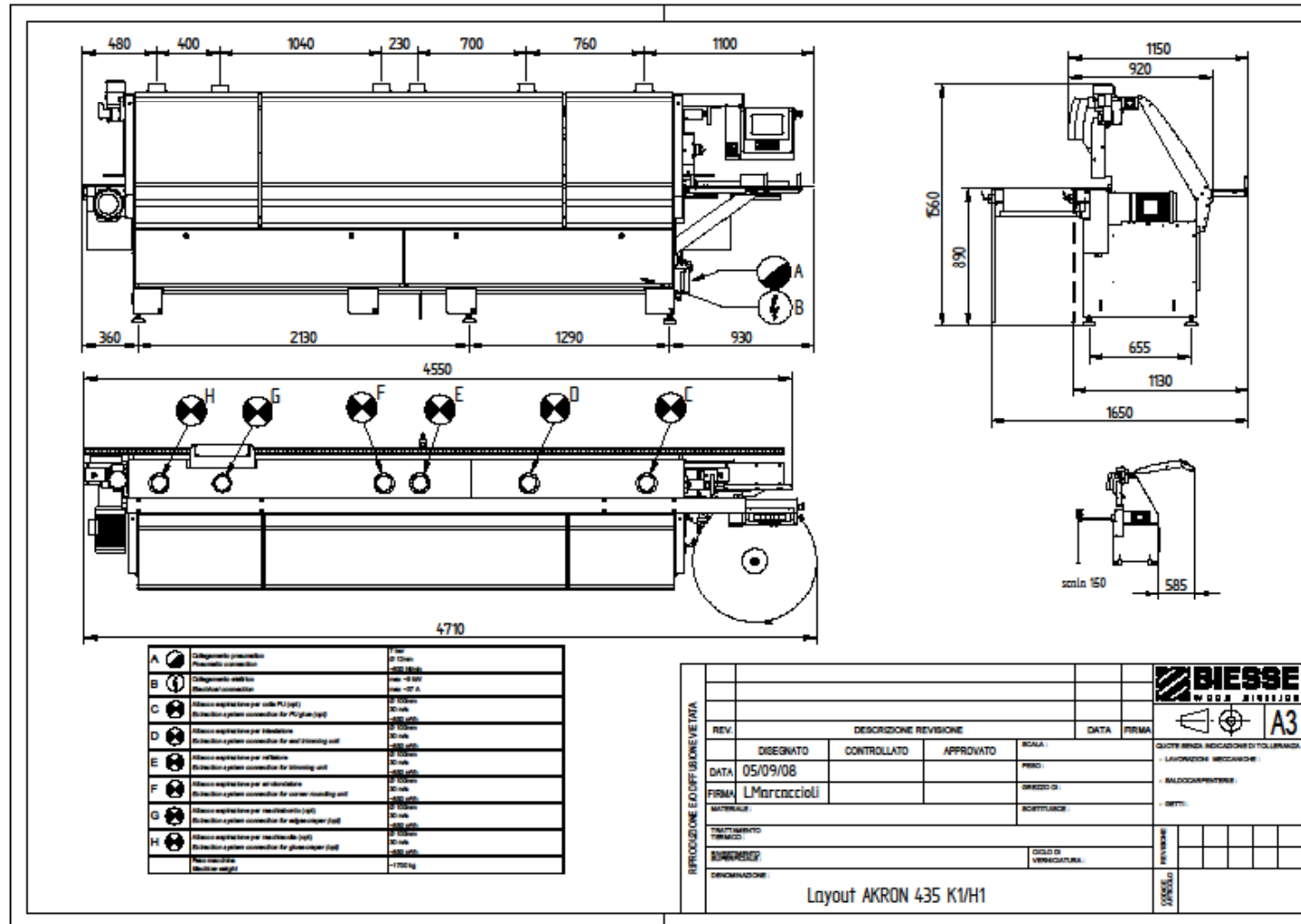

# Layout

WOOD DIVISION

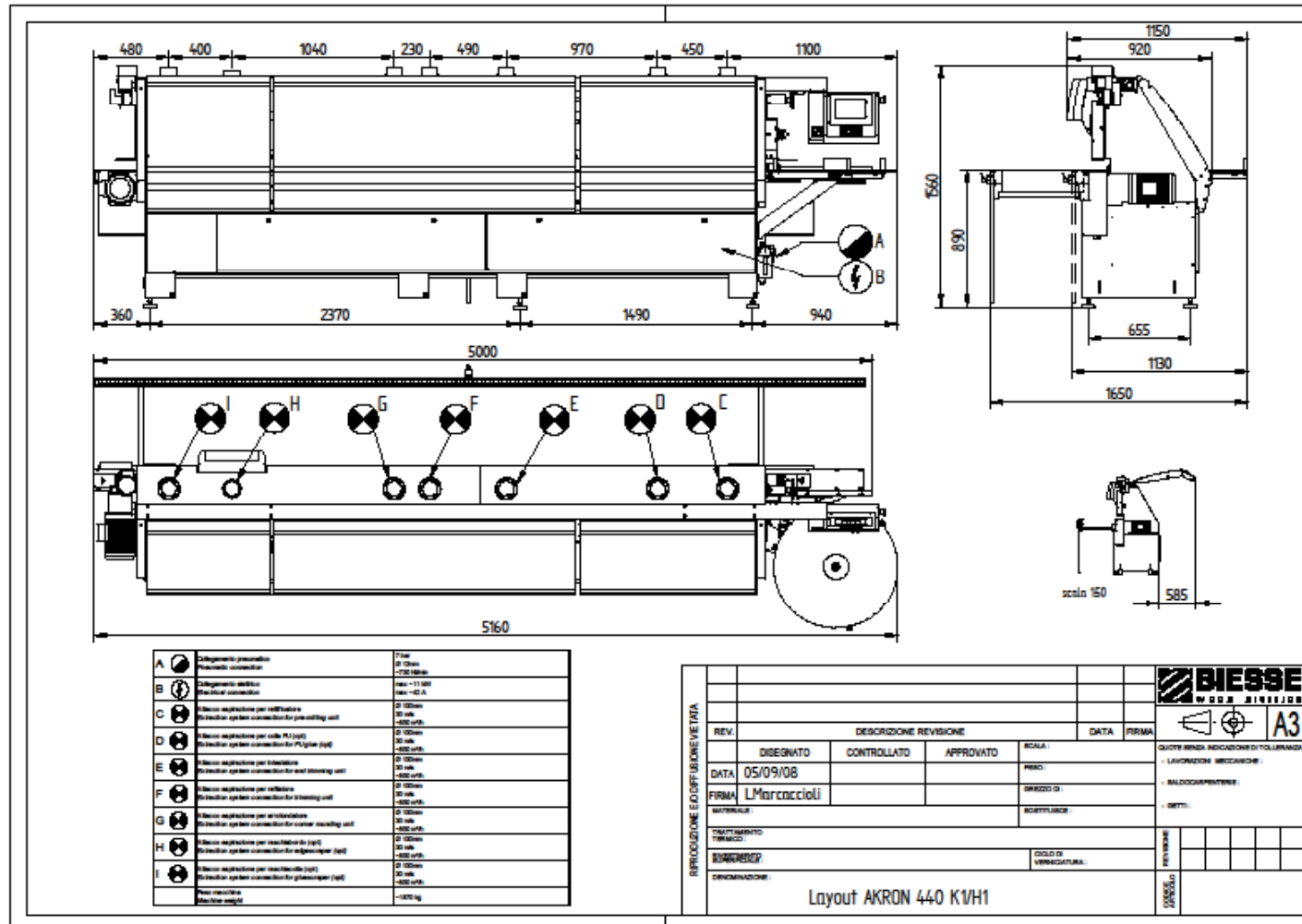

HOME



**BIESSE**